



S1	S2	S3	S4
 M6*16 M6	 M6*25 M6	 φ18	 Ø4
2 PCS	5 PCS	2PCS	2PCS

FIG.
1



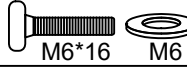
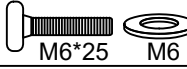
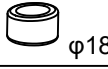

S1	S2	S3	S4
 M6*16 M6	 M6*25 M6	 φ18	 Ø4
2 PCS	5 PCS	2PCS	2PCS

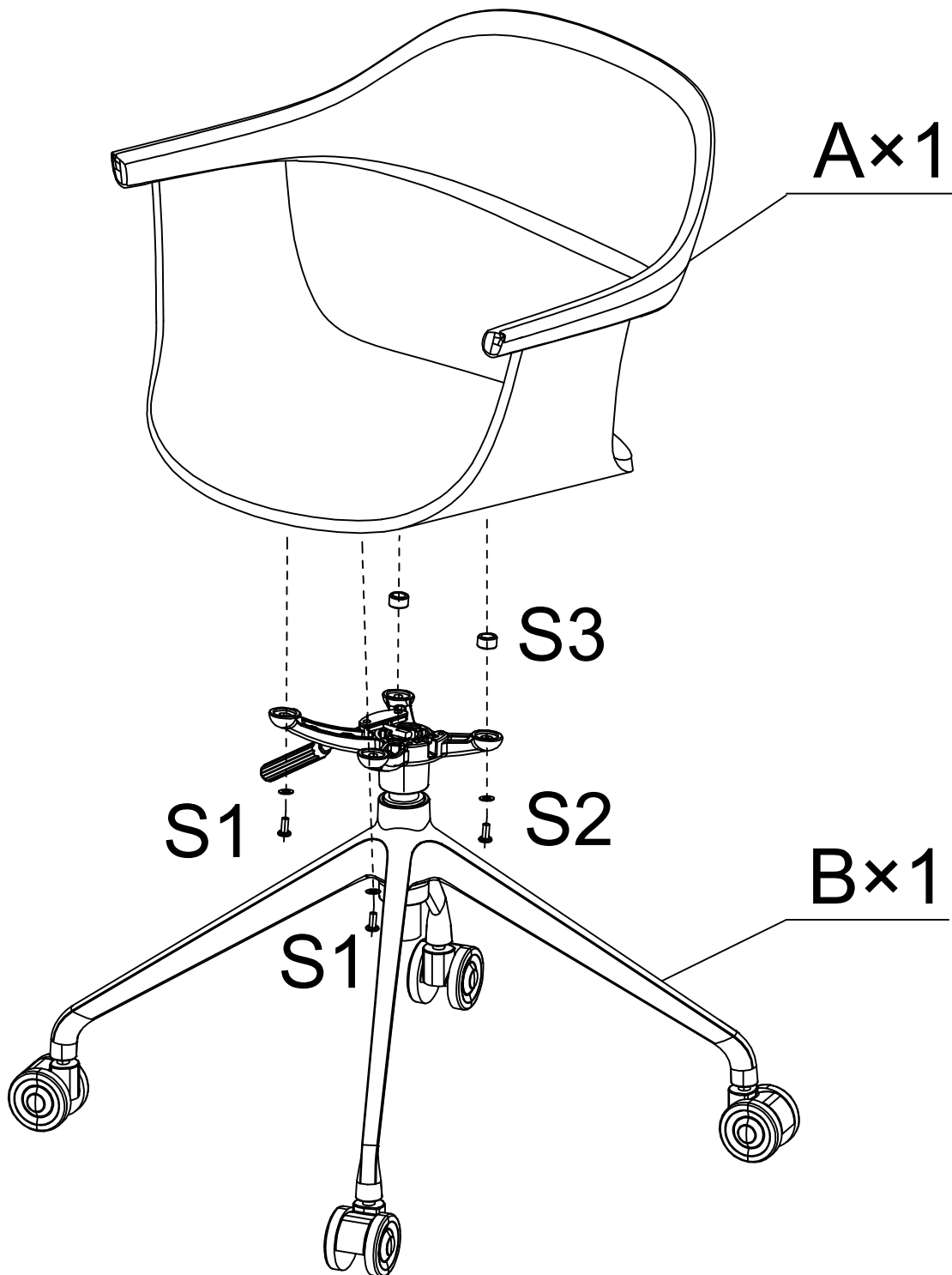
FIG.
2

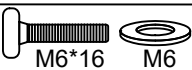
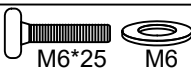
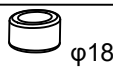