

almerich  
A NEW LIGHT





**We want to  
show you a  
new light.**



A new way of doing things is surfacing in our society and everything around us. Work, tradition and the value of well done things. Knowing how to transmit it and live it. That's what drives us. Because we don't want just to sell a product, but spreading a new way of seeing life. We want to show you a new light.

Una nueva forma de hacer las cosas está inundando nuestra sociedad y todo lo que nos rodea. El trabajo, la tradición, el valor de las cosas bien hechas. Saber transmitirlo y vivirlo. Eso es lo que nos mueve. Porque no queremos vender un producto, sino transmitir una nueva forma de ver la vida. Queremos enseñarte una nueva luz.

When in 1943 Antonio Almerich Villanueva founded the company, with very modest means, he could not have suspected how his project would develop. His fighting spirit allowed him to build what is today a modern company, in the world-wide lighting sector, providing great design and quality. Almerich has been able to evolve without losing its roots.

We know that having 75 years of history is a commitment and we firmly believe that maintaining the renewing spirit that characterizes us brings us a guarantee for the future. In each of our departments young, dynamic people - who are a constant source of new ideas - work side by side with our experienced professionals. These professional craftsmen have spent decades working within Almerich and know their craft to perfection. They convey the best of our long experience in classic design to our contemporary designs of today.

Almerich continues to reinvent itself, merging its best tradition with the most contemporary of designs, searching for sophistication based on craftsmanship, innovation and culture of design. Timelessness and sensitivity are mixed now with its maximum exigency. A new phase of hope, passion and emotion to rediscover ourselves. Image, concept, product and history. A new story. A new light.

Cuando en 1943 Antonio Almerich Villanueva fundó la empresa con medios muy modestos, no podía sospechar cómo ni por dónde se desarrollaría su proyecto. Su espíritu luchador le permitió ilusionar a los que recogimos su testigo y conformamos hoy una empresa moderna, referente en el sector de la iluminación a nivel mundial por nuestro diseño y calidad. Almerich ha sabido evolucionar sin perder sus raíces.

Sabemos que tener 75 años de historia es un compromiso y creemos firmemente que manteniendo el espíritu renovador que nos caracteriza tenemos una garantía de futuro. En cada uno de nuestros departamentos convive gente joven, dinámica y fuente de nuevas ideas con profesionales que llevan décadas en Almerich y que conocen a la perfección su oficio. Ellos han sido capaces de transmitir a los diseños contemporáneos lo mejor de nuestra larga experiencia en clásico.

Ahora, Almerich se reinventa fusionando su mejor tradición con la más actual contemporaneidad, buscando una sofisticación basada en la artesanía, la innovación y la cultura del diseño. Atemporalidad y sensibilidad se conjugan ahora con la mayor de las exigencias.

Una nueva etapa de ilusión, pasión y emoción.

Para redescubrir y redescubrirnos. Imagen, concepto, producto e historia.

Una nueva historia. A new light.



31  
**Boomerang**



77  
**Blow**



77  
**Blow**



75  
**Blow**



74  
**Blow**



83  
**Cone**

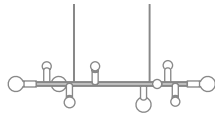

46  
**Party**



44  
**Party**



42  
**Party**

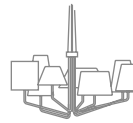

49  
**Tria**



48  
**Tria**

**Hanging Lamps**  
Colgantes

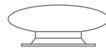

80  
**Blow**



86  
**Cap**



82  
**Cone**



16  
**Coco**



NEW!  
22  
**Coco Small**

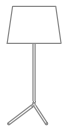

58  
**Minima**

**Table Lamps**  
Sobremesas



30  
**Boomerang**



85  
**Cone**



61  
**Minima**



60  
**Minima**

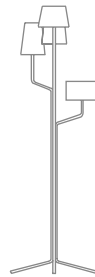

52  
**Tria**



36  
**Monsieur**

**Floor Lamps**  
Lámparas de pie



78  
**Blow**



78  
**Mini Blow**



64  
**Giro**



72  
**Maya**



88  
**Pensilis**



51  
**Tria**

**Wall Lamps**  
Apiques



78  
**Blow**



78  
**Mini Blow**

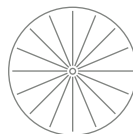

34  
**Raining day**

**Ceiling Lamps**  
Plafones



90  
**Hoffmann**



70  
**Maya**



73  
**Maya**



73  
**Maya**

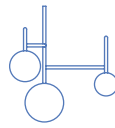

NEW!  
15  
**Moon**

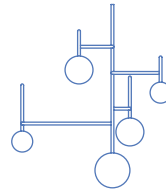

NEW!  
15  
**Moon**



41  
**Rem**



62  
**Minima**



63  
**Minima**



NEW!  
12  
**Moon**



54  
**Self**

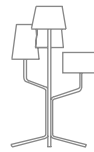

50  
**Tria**

NEW!

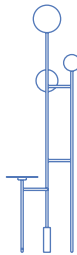

10  
**Moon**

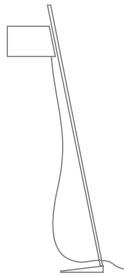

68  
**Próxima**

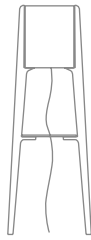

26  
**Tower**

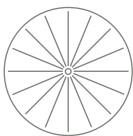

34  
**Raining day**







# MOON

Based on the astral inspiration that illuminates the space recalling the nights of full moon. Its minimalist design and the combination of its geometric forms make it have a strong character and a balanced disorder.

Bebe de la inspiración astral que ilumina el espacio recordando las noches de luna llena. Su diseño minimalista y la combinación de sus formas geométricas hacen que tenga un carácter fuerte y un desorden equilibrado.

BY AGUSKIM STUDIO

REF 62034 ENGLISH GREEN





▲ REF 61063B GOLD

REF 61063B CHROME ►





▲ REF 62034 SOFT GREEN

REF 60089 SOFT GREEN ▶



**Balanced disorder.**  
Desorden equilibrado.



REF 60088 BLACK ▶

# COCO

Characterized by contrasts; the rotundity of its geometry, the strength of the sphere opposed to the light structure and the warmth of the light. Its dome can be slightly directed in order to direct the light.

Caracterizada por los contrastes; la rotundidad de su geometría, la fuerza de la esfera contrapuesta a la ligereza visual de la estructura y la calidez de su luz. Su cúpula puede orientarse levemente con el fin de dirigir la luz.



BY ARNAU REYNA  
REF 61060B CHROME







REF 61060B GOLD





**Love for small details.**  
El amor por los pequeños detalles.



REF 61060 BLACK



# COCO small

Retains the same proportions and materials on a smaller scale, making it possible to incorporate it in reduced surfaces, shelves and auxiliary tables. The warmth of its light and the movement of its dome are maintained as a sign of identity.

Conserva las mismas proporciones y materiales en una escala menor, posibilitando incorporarla en superficies reducidas, estanterías y mesas auxiliares. La calidez de su luz y el movimiento de su cúpula se mantienen como seña de identidad.

BY ARNAU REYNA

REF 61061 WHITE







REF 61061B FUME · 61060 WHITE



# TOWER

Inspired in the old deposits of water, its tripod-shaped structure has a great sculptural character as well as total functionality, thanks to the addition of an auxiliary tray as a support table.

Inspirado en los antiguos depósitos de agua, su estructura en forma de trípode tiene un gran carácter escultórico además de una funcionalidad total, gracias a la incorporación de una bandeja auxiliar como mesa de apoyo.

BY HUGO TEJADA

REF 62029 BLACK











# BOOMERANG

Inspired on the sequence of images of a boomerang in movement, this light shows this dynamism through a repetition of triangular sections piled together.

Inspirado en la secuencia de imágenes de un boomerang en movimiento, capta la belleza de este dinamismo a través de la repetición de una sección triangular.

BY LUIS ESLAVA

◀ FLOOR LAMP REF 62023 WHITE

PENDANT REF 60052 SLATE BLUE ▲





◀ PENDANT REF 60052 GREY GREEN

TABLE LAMP TRIA 61050B SOFT GREEN ▶





# RAINING DAY

Created like a wall installation of oriental umbrellas. This sculptural piece transforms light like a leaden sky and nostalgic filter, like a raining day in Kyoto.

Creada como una instalación mural de sombrillas orientales. Esta pieza escultórica transforma la luz como un filtro plomizo y nostálgico, como un día de lluvia en Kyoto.

BY MERMELADA ESTUDIO

REF 64019 - 64020 - 64021 WHITE

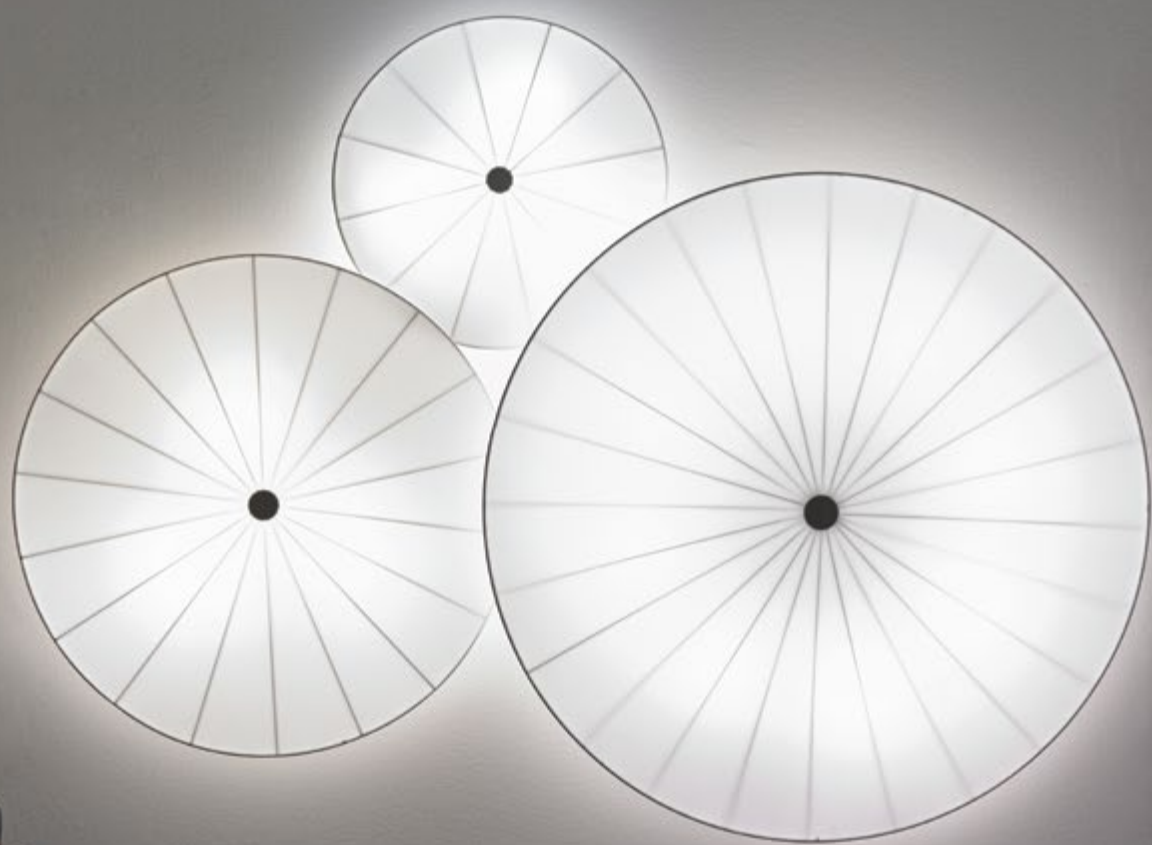

# MONSIEUR

Lightweight, stable and can be placed in virtually any space. It has a small support surface adjustable in height and its rotation system allows to adapt the direction of light.

Ligera, estable y puede ser colocada en prácticamente cualquier espacio. Dispone de una pequeña superficie de apoyo regulable en altura y su sistema de rotación permite adaptar la dirección de la luz.

BY THE EMOTION LAB  
REF 62026 SOFT GREEN



**Timeless and  
sensitivity.**



REF 62026 FOG BLUE - SOFT GREEN









# REM

A very versatile and simple piece, which offers a game of direct and suggestive light perfect for any space.

De gran versatilidad y sencillez. Ofrece un juego de luz indirecta y sugerente perfecta para todo tipo de espacios.

BY YONOH  
REF 60050 - 60051 WHITE

◀ REF 60050 SOFT GREEN

# PARTY

Inspired in the garlands of bulbs of popular festivities, party transports us with nostalgia and moves this emotions to the interior design of spaces.

Inspirada por las guirnaldas de bombillas de las fiestas populares, Party nos transporta la nostalgia y traslada esas emociones al interior de los espacios.

BY ESTUDIO SAVAGE

REF 60081B CHROME







REF 60087B GOLD



# A new way of doing things



REF 60086B CHROME





# TRIA Collection



Tria revitalises the archetype of classic chandelier with a configuration of four shades each with a unique geometry and dimension. It is characterized by its strong personality and its absolute contemporary look with a classic touch.

Tria revitaliza el arquetipo de lámpara clásica con una configuración de 4 pantallas de diferentes geometrías y tamaños. Caracterizada por su fuerte personalidad y su aspecto totalmente contemporáneo con cierto sabor clásico.

BY LUIS ESLAVA

REF 60071B CORAL PINK

63021 WHITE



▲ REF 61050B FOG BLUE

REF 63021B SLATE BLUE ►





REF 62025B SLATE BLUE



# SELF

With its twisting base and cap shade, Self aims to create a visual play, as the structure and shade have feedback and become a single piece.

De base zigzagueante y pantalla en forma de caperuza, Self busca crear un juego visual por el cual toda la lámpara, tanto su estructura como la pantalla, son una sola pieza.

BY LUIS ESLAVA  
REF 61044 QUARTZ PINK







**Honesty and  
authenticity.**





# MINIMA

It is the minimum expression, pure essence dispossessed of all ornaments. Its monomateriality in metallic finishes, the extreme simplicity of its forms and pure lines are the most personal characteristic.

Es la mínima expresión, despojada de todo elemento sobrante. Su monomaterialidad en acabados metálicos, la simplicidad de sus formas y líneas puras son su rasgo más personal.

BY ARNAU REYNA

◀ TABLE LAMP REF 61057B GOLD

FLOOR LAMP 62032B GOLD ▶



▲ FLOOR LAMP REF 62033 BLACK FLOOR LAMP 62032 SOFT GREEN ►





▲ TABLE LAMP REF 61058 CORAL PINK

TABLE LAMP 61059 WHITE ▶



**Tradition and  
contemporaninity.**



# GIRO

Simple, discreet, elegant and sophisticated. Thanks to its studied way of turning, we can direct the light to almost any direction.

Sencillo, discreto, elegante y sofisticado. Gracias a su estudiado giro podemos orientar la luz prácticamente en cualquier dirección.

BY NACHO TIMÓN

REF 63035B GOLD - 63035 WHITE - 63035 BLACK







**GIRO**

REF 63035B GOLD - 63035 WHITE - 63035 BLACK



# PROXIMA

A timeless piece which unmistakable authorship reports about the richness of shades and treatment of materials.

Un clásico atemporal cuya autoría inconfundible se delata por la riqueza de matices y tratamiento de los materiales.



BY MIQUEL MILÁ  
REF 62004 GLAZED NICKEL



# MAYA

BY MERMELADA ESTUDIO  
REF 60060 BLACK







REF 63031 FOG BLUE





**Maya is a modular lamp, that can grow, generating different compositions because of its hexagonal geometry and conicity inspired in a beehive.**

Maya es una lámpara modular, que puede crecer generando diferentes composiciones gracias a su geometría cónica y hexagonal inspirada en los panales de abejas.



# BLOW Collection



BY CLAUDIO ZAPPONE - GIORGIO PALERMO

◀ MINI BLOW REF 60025 WHITE

BLOW REF 60058 GLAZED NICKEL ▶



▲ BLOW REF 60024B CHROME

BLOW REF 60046B GLAZED NICKEL ►

**Blow is a timeless collection inspired by sputnik lamps designed in the 50's. Every piece transmits warmth and a charming light that envelops spaces with sophistication and elegance.**

Blow es una colección atemporal inspirada por las lámparas Sputnik diseñadas en los 50.

Cada pieza transmite calidez y una iluminación amable que envuelve los espacios con sofisticación y elegancia.





REF 60046B GLAZED NICKEL





## BLOW & Mini BLOW wall lamp

BY CLAUDIO ZAPPONE - GIORGIO PALERMO

Mini BLOW 63019B GOLD

BLOW 64012 NICKEL

COCO 61060B CHROME







## BLOW table lamp

BY CLAUDIO ZAPPONE - GIORGIO PALERMO

REF 61041B GOLD

MINIMA 62032 SOFT GREEN ▲





# CONE Collection

Focused on the simplicity of its shapes, reducing its morphology to a set of basic pieces that play with light direction.

Una apuesta por la simplicidad de las formas, reduciendo su morfología a un juego de piezas básicas que juegan con la orientación de la luz.

BY ROGER PERSSON

◀ REF 610454 WHITE

PENDANT 60085B CHROME ▶





PENDANT 60085B GOLD

FLOOR LAMP 62031 BLACK

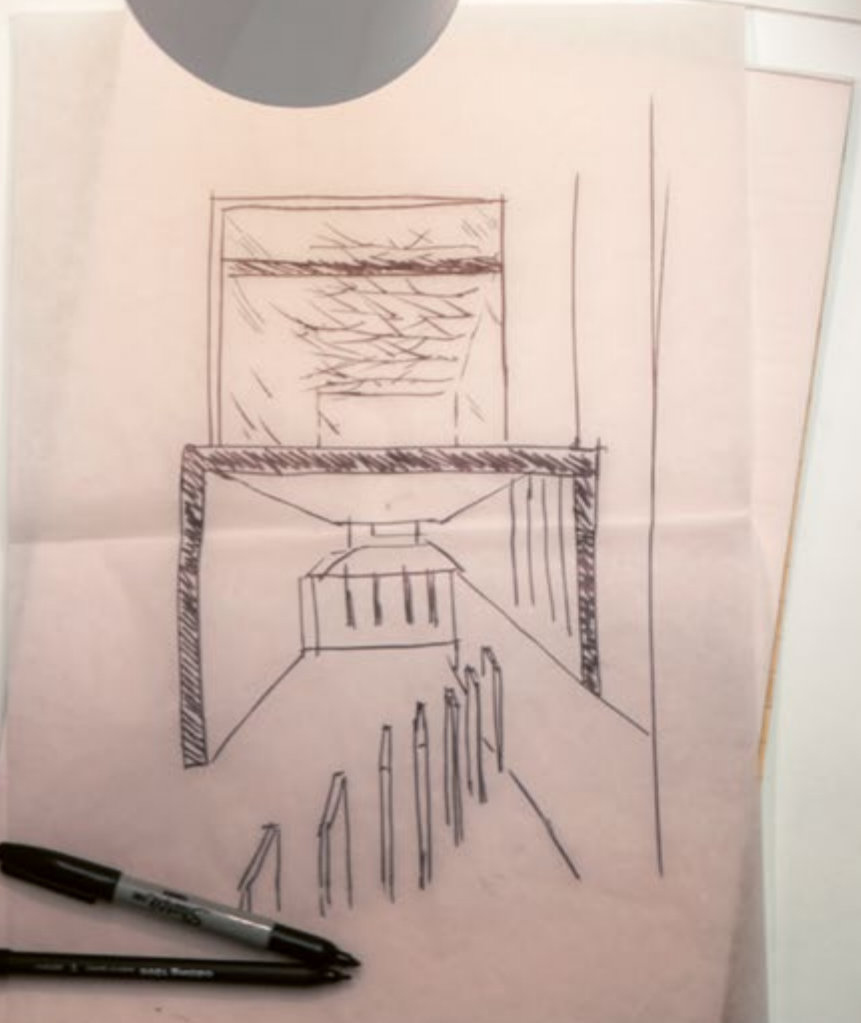



# CAP

A task piece that plays with its dual symmetry. Its base repeats the geometry of the shade to be a container and save space in the desk surface.

Pieza de escritorio que juega con la dualidad de su simetría. Su base repite la geometría de la pantalla para generar una pieza de contenedor y así ahorrar espacio en la superficie del escritorio.

BY LUIS ESLAVA  
REF 61046 WHITE



# PENSILIS

Wall collection of rotund and simple geometry inspired by origami. Can be installed independently or create diverse sets by playing with all four sizes and their disposition.

Colección mural de geometría rotunda y sencilla inspirada en la papiroflexia. Puede instalarse de forma independiente o crear diversos conjuntos con los cuatro tamaños y su disposición.

BY CÍSCAR & GARCIA

REF 63026 - 63027 - 63028 - 63029 WHITE - BLACK





# HOFFMAN

Timeless and versatile for all types of spaces and projects. Hoffman is an off-road piece for its classic and polished aspect.

De carácter atemporal y polivalente para todo tipo de espacios y proyectos. Hoffman es una pieza todoterreno por su aspecto clásico y depurado.

BY ESTUDIO ALMERICH

60001 BLACK - 60002 BLACK - 60002B GOLD - 60003 BLACK







CONE 62031 BLACK ▲





## INTRODUCTION

All the lighting fixtures of this catalogue are produced in our Factory in Valencia (Spain). The label MADEINEU ® guarantees that the design and manufacturing process of these products are European. We have always worked with freelance designers from different nationalities, what is reflected in the International personality of our designs.

We offer an important and differentiator competitive advantage for the Contract business as we can make any formal change in any of our Exclusive Designs to adapt them for our customer's projects.

The Designs included in this technical brochure are original and exclusive by ALTIMA INNOVA, S.L.

## RECOMENDATIONS

We advise to install the lamps respecting the maximum voltages as indicated in this technical catalogue for each model. In case you want to use different bulbs as suggested, we welcome you to ask our technical department before for approval in advance in order to avoid possible damages to the fixture. In case that you do not proceed in such way, we are not responsible of any harm caused to the fixture for such reason. All our fixtures comply with all technical specifications and certifications for the country of destination. All our fixtures have a guarantee label that also mentions the maintenance and assembling. Please be welcome to send us any request that you may have by mail to [export@almerich.com](mailto:export@almerich.com) or by phone (+34) 961 343 234

Altima Innova bets for the constant improvement of its products so the design, configuration or specifications in this catalogue may vary.

© Copyright 2017. ALTIMA INNOVA, S.L.

## INTRODUCCIÓN

Todas las Luminarias que componen este Catálogo Técnico están fabricadas en nuestras instalaciones de Valencia-España. La etiqueta MADEINEU ® garantiza que el diseño y la fabricación de este producto son europeos. Desde siempre colaboramos con diseñadores Free-Lance de diferentes nacionalidades, ofreciendo al mercado Diseños con un marcado carácter Internacional.

Ofrecemos una ventaja competitiva muy importante y diferenciadora para el mercado del Contract, podemos realizar cambios formales sobre todos nuestros Diseños Exclusivos adaptándolos tanto en medidas como en acabados para los Proyectos de nuestros clientes, así como otras peticiones que se nos requieran.

Los diseños que contienen este catálogo-técnico son originales y exclusivos de "ALTIMA INNOVA, S.L."

## RECOMENDACIONES

Se recomienda instalar lámparas respetando los máximos de potencia que se indican en este Catálogo Técnico para cada una de las Luminarias. En caso de querer emplear lámparas diferentes a las indicadas aconsejamos nos hagan previamente la consulta para que nuestro Departamento Técnico les informe sobre su conveniencia o no y así poder evitar daños en la luminaria donde se instalen, en caso de no hacerlo no nos hacemos responsables de ningún daño que esto pudiese ocasionar. Todas nuestras Luminarias cumplen las Especificaciones Técnicas y Certificaciones que se requieren en el país de destino. A todas nuestras Luminarias se les adjunta una Etiqueta de Garantía en la que además se especifica el mantenimiento y montaje de las Luminarias. Cualquier consulta que desee hacernos puede realizarla por medio de nuestro correo electrónico [export@almerich.com](mailto:export@almerich.com) o telefónicamente al (+34) 961 343 234

Altima Innova apuesta por la constante mejora de sus productos, por lo que el diseño, configuración y especificaciones que aparecen en este catálogo técnico pueden estar sujetas a modificaciones.

© Copyright 2017. ALTIMA INNOVA, S.L.



	PAG	COLLECTION COLECCIÓN
<b>PENDANTS COLGANTES</b>		
	98	BOOMERANG
	98	BLOW
	98	BLOW
	99	BLOW
	99	miniBLOW
	99	CONE
	100	HOFFMAN
	100	HOFFMAN
	100	HOFFMAN
	100	MAYA
	100	MAYA
	101	MAYA
	101	MOON
	101	MOON
	102	PARTY
	102	PARTY
	102	PARTY
	103	REM
	103	REM
	103	TRIA
	103	TRIA
<b>TABLE LAMPS SOBREMESAS</b>		
	104	BLOW
	104	CAP
	104	CONE
	105	COCO
	105	COCO <small>small</small>
	105	MINIMA
	106	MINIMA
	106	MINIMA
	106	MOON
	107	SELF
	107	TRIA
<b>FLOOR LAMPS LÁMPARAS DE PIE</b>		
	108	BOOMERANG
	108	CONE
	108	CONE
	108	MINIMA
	109	MINIMA
	109	MONSIEUR
	109	MOON
	110	PROXIMA
	110	TOWER
	110	TRIA
<b>WALL LAMPS APLIQUES</b>		
	111	BLOW
	111	miniBLOW
	111	GIRO
	112	MAYA
	112	TRIA
	112	PENSILIS
	112	PENSILIS
	112	PENSILIS
	112	PENSILIS
<b>CEILING LAMPS PLAFONES</b>		
	113	BLOW
	113	miniBLOW
	113	RAINING DAY
	113	RAINING DAY
	113	RAINING DAY

**BOOMERANG**  
LUIS ESLAVA



REF 60052  
MATERIAL  
Coated steel sheets and glass

MATERIAL  
Plancha de acero lacado

LED  
E27 GLOBUS 13W 270° x 1 unit

LACQUERED

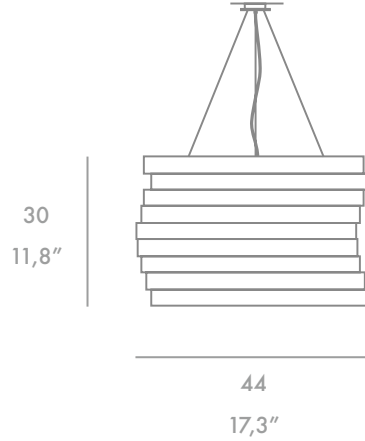

**BLOW**  
CLAUDIO ZAPONNE  
& GIORGIO PALERMO



REF 60046  
MATERIAL  
Rotational moulded  
polymer diffusers and  
steel structure.  
Lacquered

MATERIAL  
Difusor de polimero  
por rotomoldeo y  
estructura de acero.  
Lacado

LED  
E27 7W 360° x 2 units

REF 60046B  
MATERIAL  
Rotational moulded  
polymer diffusers and  
steel structure.  
Metallic

MATERIAL  
Difusor de polimero  
por rotomoldeo y  
estructura de acero.  
Metálico

LACQUERED



METALLIC

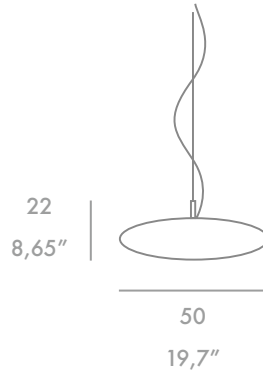

**BLOW**  
CLAUDIO ZAPONNE  
& GIORGIO PALERMO



REF 60058  
MATERIAL  
Rotational moulded polymer diffusers and steel  
structure.

MATERIAL  
Difusor de polimero por rotomoldeo y estructura  
de acero

LED  
E27 7W 360° x 18 units

LACQUERED



METALLIC

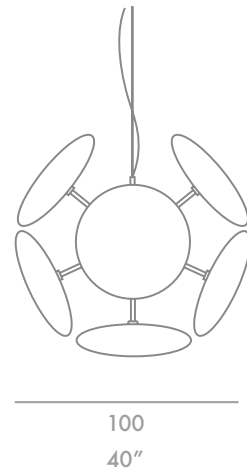

## BLOW

CLAUDIO ZAPONNE  
& GIORGIO PALERMO



REF 60024B

**MATERIAL**  
Rotational moulded  
polymer diffusers and  
steel structure.  
**Metallic**

**MATERIAL**  
Difusor de polímero  
por rotomoldeo y  
estructura de acero.  
Metálico

**LED**  
E27 7W 360° x 34 units

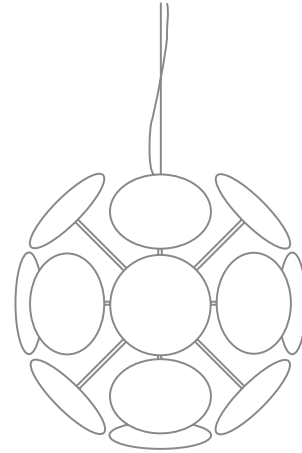

146  
57,5"

LACQUERED



METALLIC



144  
56,7"

## mini BLOW

CLAUDIO ZAPONNE  
& GIORGIO PALERMO



REF 60025

**MATERIAL**  
Pyrex diffusers and  
steel structure.  
**Lacquered**

**MATERIAL**  
Difusor de pyrex y  
estructura de acero.  
Lacado

**LED**  
G9 4W 360° x 13 units

REF 60025B

**MATERIAL**  
Pyrex diffusers and  
steel structure.  
**Metallic**

**MATERIAL**  
Difusor de pyrex y  
estructura de acero.  
Metálico

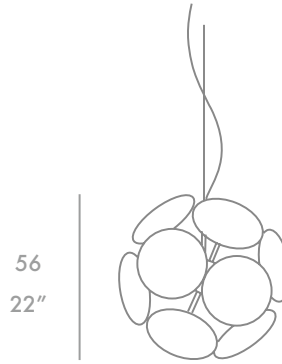

56  
22"

LACQUERED



METALLIC



50  
19,7"

## CONE

ROGER PERSSON



REF 60085

**MATERIAL**  
Steel  
**Lacquered**

**MATERIAL**  
Acero  
Lacado

**LED**  
E27 12W x 1 unit

REF 60085B

**MATERIAL**  
Steel  
**Metallic**

**MATERIAL**  
Acero  
Metálico

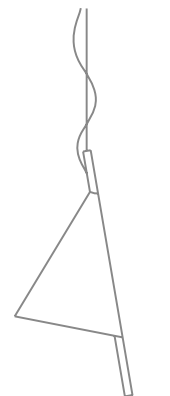

22  
8,65"

LACQUERED



METALLIC



13  
5,1"

**HOFFMAN**  
ESTUDIO ALMERICH

REF 60001 - 60002 - 60003  
REF 60001B - 60002B - 60003B

MATERIAL  
Opal glass and brass  
Lacquered - (B) Metallic

MATERIAL  
Vidrio opal y latón  
Lacado - (B) Metálico

LED  
E27 7W 360° x 1unit  
E27 9W 360° x 1unit  
E27 12W 360° x 1unit



60001

60002

60003

24  
9,45"



31  
12,2"



36  
14,2"

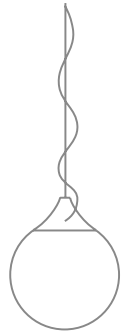

18

7"

25

9,8"

30

11,8

LACQUERED



METALLIC (B)



**MAYA**  
MERMELADA ESTUDIO

REF 60060

MATERIAL  
Aluminium

MATERIAL  
Aluminio

LED  
E27 12W 360° x 1unit



38,5

15,1"

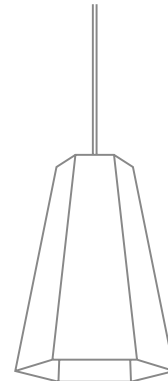

25

9,8"

LACQUERED



**MAYA**  
MERMELADA ESTUDIO

REF 60061

MATERIAL  
Aluminium

MATERIAL  
Aluminio

LED  
E27 12W 360° x 3 units



38,5

15,1"

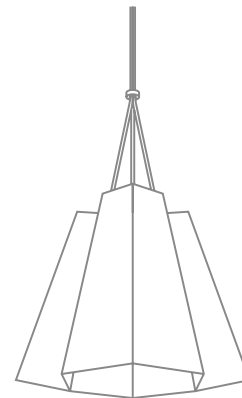

45

17,7"

LACQUERED



**MAYA**  
MERMELADA ESTUDIO



REF 60062

MATERIAL  
Aluminium

MATERIAL  
Aluminio

LED  
E27 12W 360° x 6 units

LACQUERED

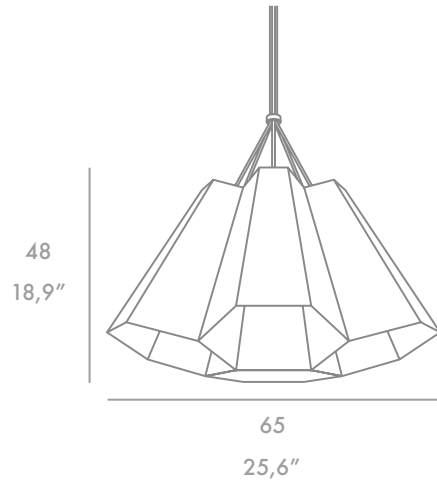

**MOON** NEW!  
AGUS KIM



REF 60088

MATERIAL  
Steel  
Lacquered

MATERIAL  
Aluminio  
Lacado

LED  
E14 4W  
E27 7W  
E27 9W

REF 60088B

MATERIAL  
Steel  
Metallic

MATERIAL  
Acero  
Metálico

LACQUERED



METALLIC

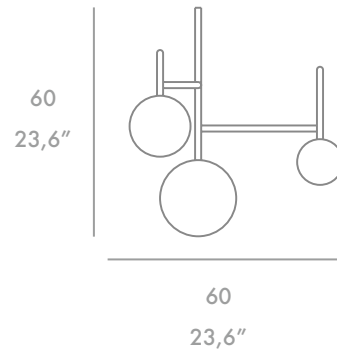

**MOON** NEW!  
AGUS KIM



REF 60089

MATERIAL  
Aluminium  
Lacquered

MATERIAL  
Aluminio  
Lacado

LED  
E14 4W x 2 units  
E27 7W x 2 units  
E27 9W

REF 60089B

MATERIAL  
Steel  
Metallic

MATERIAL  
Acero  
Metálico

LACQUERED



METALLIC

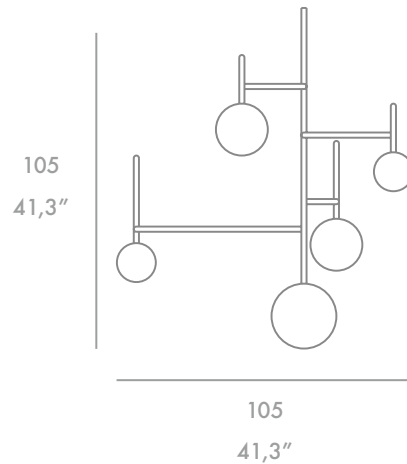

**PARTY**  
ARNAU REYNA



REF 60086      REF 60086B  
**MATERIAL**  
 Brass              Brass  
 Lacquered        Metallic

**MATERIAL**  
 Latón              Latón  
 Lacado            Metálico

**LED (INCLUDED)**  
 E27 7W x 10 units

LACQUERED    B. METALLIC



**Warm light**  
 Luz cálida

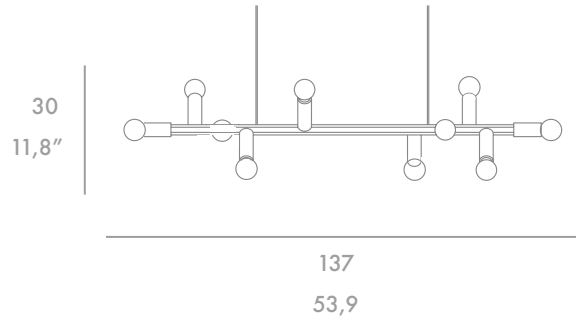

**PARTY**  
ARNAU REYNA



REF 60087      REF 60087B  
**MATERIAL**  
 Brass              Brass  
 Lacquered        Metallic

**MATERIAL**  
 Latón              Latón  
 Lacado            Metálico

**LED (INCLUDED)**  
 E27 7W x 10 units

LACQUERED    METALLIC



**Warm light**  
 Luz cálida

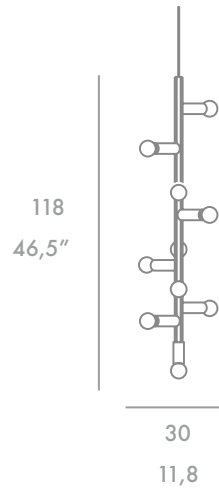

**PARTY**  
ARNAU REYNA



REF 60081      REF 60081B  
**MATERIAL**  
 Brass              Brass  
 Lacquered        Metallic

**MATERIAL**  
 Latón              Latón  
 Lacado            Metálico

**LED (INCLUDED)**  
 E27 7W x 7 units

LACQUERED    METALLIC



**Warm light**  
 Luz cálida

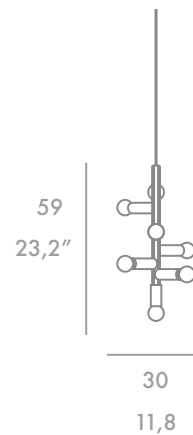

**REM**  
**YONOH**

REF 60050 - 60051

**MATERIAL**  
Aluminium

**MATERIAL**  
Aluminio

**LED**  
E27 GLOBUS 13W 270° x 1 unit



60050

60051

50  
19,65"

40  
15,75"

46  
18"

46  
18"

LACQUERED



**TRIA**  
**LUIS ESLAVA**

REF 60071B

REF 60071

**MATERIAL**  
Steel

**MATERIAL**  
Steel and textile shades

**MATERIAL**  
Acero

**MATERIAL**  
Acero y pantallas textiles

**LED**  
E14 4W x 5 units

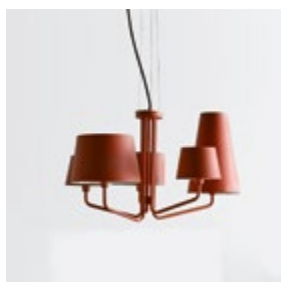

44  
17,3"

70  
27,55"

LACQUERED

TEXTILES



**TRIA**  
**LUIS ESLAVA**

REF 60068B

REF 60068

**MATERIAL**  
Steel

**MATERIAL**  
Steel and textile shades

**MATERIAL**  
Acero

**MATERIAL**  
Acero y pantallas textiles

**LED**  
E14 4W x 8 units



54  
21,3"

115  
45,3"

LACQUERED

TEXTILES



**BLOW**  
CLAUDIO ZAPONNE  
& GIORGIO PALERMO



REF 61041  
MATERIAL  
Plastic diffuser and steel structure. Epoxi finish. Outdoor / indoor

MATERIAL  
Difusor de plástico y estructura de acero. Pintura epoxi. Exterior / interior

LED  
E 27 7W 360° x 2 units

REF 61041B  
MATERIAL  
Plastic diffuser and steel structure. Metallic finish. Only indoor

MATERIAL  
Difusor de plástico y estructura de acero. Acabado metálico. Sólo para interior

LACQUERED



METALLIC (Only indoor / solo para interiores)



19,5  
7,7"

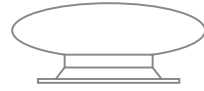
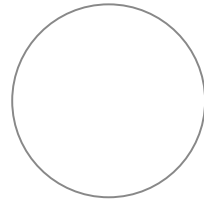

50  
19,7"

**CAP**  
LUIS ESLAVA



REF 61046  
MATERIAL  
Steel

MATERIAL  
Acero

LED  
GU10 7W x 1 unit

LACQUERED



44  
17,3"

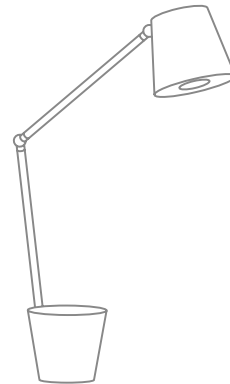

40  
15,75"

**CONE**  
ROGER PERSSON



REF 61054  
MATERIAL  
Aluminium  
Lacquered

MATERIAL  
Aluminio  
Lacado

LED  
E27 12W x 1 unit

REF 61054B  
MATERIAL  
Aluminium  
Metallic

MATERIAL  
Aluminio  
Metálico

LACQUERED



METALLIC



68  
9,8"

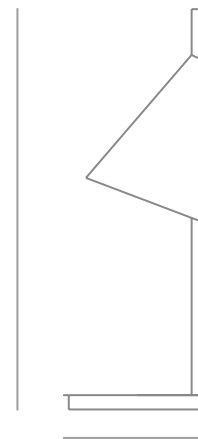

25  
26,8"



**COCO**  
ESTUDIO SAVAGE



REF 61060  
MATERIAL  
Aluminium  
Lacquered

REF 61060B  
MATERIAL  
Brass  
Metallic

MATERIAL  
Aluminio  
Lacado

MATERIAL  
Latón  
Metálico

LED  
E27 GLOBUS 9W Ø 95 x 1 unit

LACQUERED



METALLIC

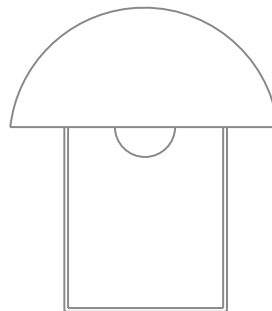

40  
15,7"

35  
13,8"

**COCO SMALL** NEW!  
ESTUDIO SAVAGE



REF 61061  
MATERIAL  
Aluminium  
Lacquered

REF 61061B  
MATERIAL  
Brass  
Metallic

MATERIAL  
Aluminio  
Lacado

MATERIAL  
Latón  
Metálico

LED  
E27 7W x 1 unit

LACQUERED



METALLIC

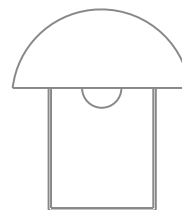

28  
11"

25  
9,84"

**MINIMA**  
ESTUDIO SAVAGE



REF 61057  
MATERIAL  
Brass  
Lacquered

REF 61057B  
MATERIAL  
Brass  
Metallic

MATERIAL  
Latón  
Lacado

MATERIAL  
Latón  
Metálico

LED  
E14 7W x 1 unit

LACQUERED



METALLIC

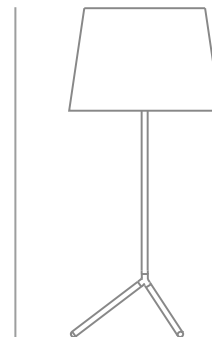

56  
9,84"

25  
22"

**MINIMA**  
ESTUDIO SAVAGE



REF 61059  
MATERIAL  
Brass  
Lacquered

MATERIAL  
Latón  
Lacado

LED  
E14 7W x 1unit

REF 61059B  
MATERIAL  
Brass  
Metallic

MATERIAL  
Latón  
Metálico

82  
32,3"



20  
7,9"

LACQUERED



METALLIC



**MINIMA**  
ESTUDIO SAVAGE



REF 61058  
MATERIAL  
Brass  
Lacquered

MATERIAL  
Latón  
Lacado

LED  
E14 7W x 1unit

REF 61058B  
MATERIAL  
Brass  
Metallic

MATERIAL  
Latón  
Metálico

82  
32,3"

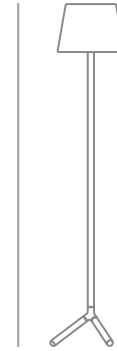

16  
6,3"

LACQUERED



METALLIC



**MOON** NEW!  
AGUS KIM



REF 61063  
MATERIAL  
Steel  
Lacquered

MATERIAL  
Acero  
Lacado

LED  
E14 4W  
E27 9W

REF 61063B  
MATERIAL  
Steel  
Metallic

MATERIAL  
Acero  
Metálico

40  
15,7"

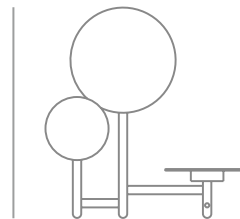

38  
15"

LACQUERED



METALLIC



**SELF**  
LUIS ESLAVA

REF 61044  
MATERIAL  
Steel

MATERIAL  
Acero

LED  
E27 7W x 1 unit

LACQUERED

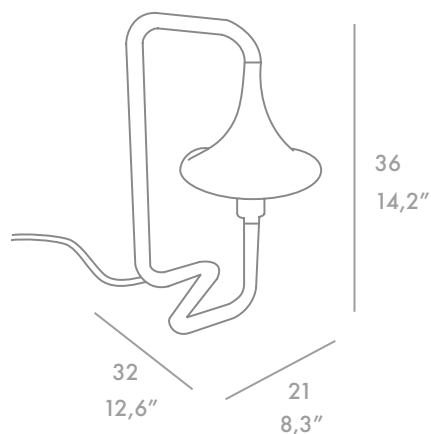

**TRIA**  
LUIS ESLAVA

REF 61050B  
MATERIAL  
Steel

MATERIAL  
Acero

LED  
E14 4W x 4 units

REF 61050  
MATERIAL  
Steel and textile shades

MATERIAL  
Acero y pantallas textiles

LACQUERED



TEXTILES (OPTIONAL)

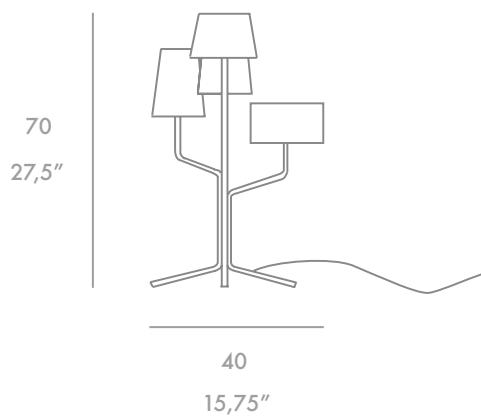

**BOOMERANG**  
LUIS ESLAVA



REF 62023

MATERIAL  
Coated steel sheets

MATERIAL  
Plancha de acero lacado

LED  
E27 GLOBUS 13W 270° x 1unit

LACQUERED

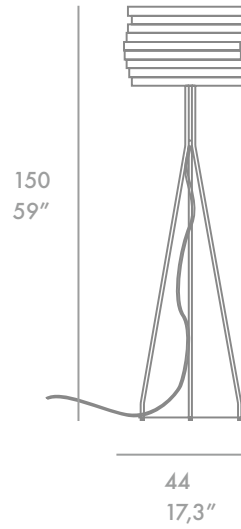

**CONE**  
ROGER PERSSON



REF 62030 - 62031

MATERIAL  
Metal

MATERIAL  
Metal

LED  
E27 12W x 2 units

LACQUERED

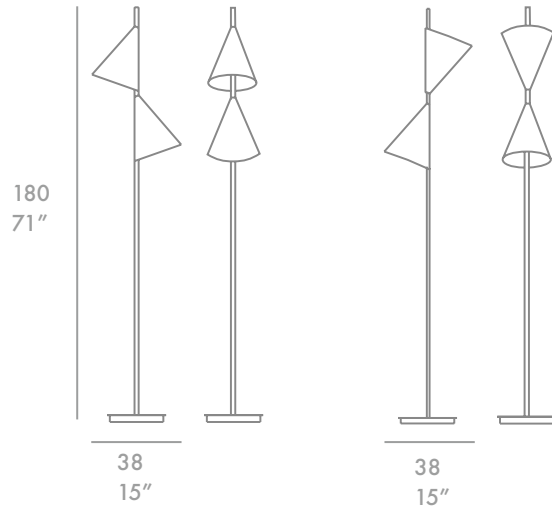

**MINIMA**  
ESTUDIO SAVAGE



REF 62032

MATERIAL  
Brass  
Lacquered

MATERIAL  
Latón  
Lacado

LED  
E14 7W x 1unit

REF 62032B

MATERIAL  
Brass  
Metallic

MATERIAL  
Latón  
Metálico

LACQUERED



METALLIC

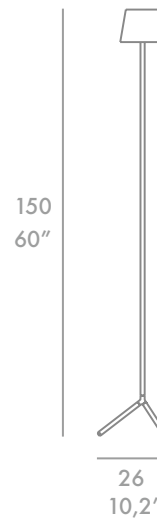

**MINIMA**  
ESTUDIO SAVAGE



REF 62033  
MATERIAL  
Brass  
Lacquered

MATERIAL  
Latón  
Lacado

LED  
E14 7W x 1 unit

REF 62033B  
MATERIAL  
Brass  
Metallic

MATERIAL  
Latón  
Metálico

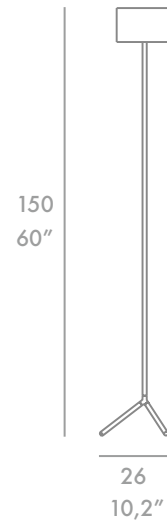

LACQUERED



METALLIC



**MONSIEUR**  
THE EMOTION LAB



REF 62026  
MATERIAL  
Metal

MATERIAL  
Metal

LED  
E27 PAR30 12W x 1 unit

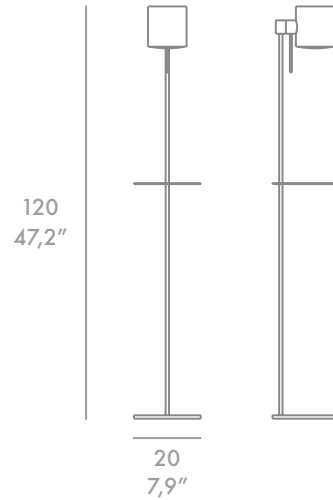

LACQUERED



**MOON** NEW!  
AGUS KIM



REF 62034  
MATERIAL  
Steel  
Lacquered

MATERIAL  
Acero  
Lacado

LED  
E14 4W x 1 unit  
E27 7W x 1 unit  
E27 9W x 1 unit

REF 62034B  
MATERIAL  
Steel  
Metallic

MATERIAL  
Acero  
Metálico

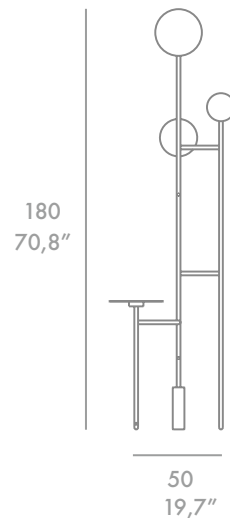

LACQUERED (ALUMINIUM)



METALLIC (STEEL)



**PRÓXIMA**  
**MIQUEL MILÀ**

REF 62004

MATERIAL  
Metal

MATERIAL  
Metal

LED  
E27 11W° x 1unit

METALLICS



170  
67"

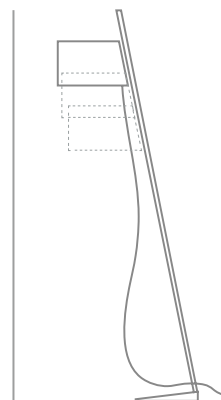

60  
23,6"

**TOWER**  
**HUGO TEJADA**

REF 62029

MATERIAL  
Metal

MATERIAL  
Metal

LED  
E27 13W 270° x 1unit

LACQUERED



140  
55"

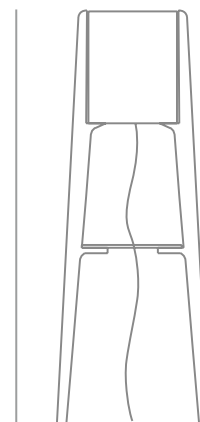

50  
19,7"

**TRIA**  
**LUIS ESLAVA**

REF 62025B

MATERIAL  
Steel

MATERIAL  
Acero

LED  
E14 4W x 4 units

REF 62025

MATERIAL  
Steel and textile shades

MATERIAL  
Acero y pantallas textiles

LACQUERED



TEXTILES

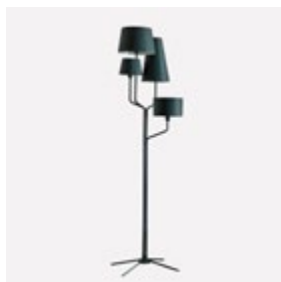

167  
65,75"

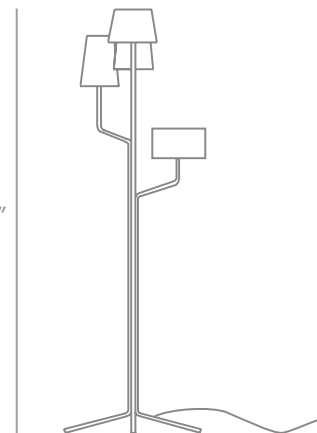

55  
21,65"

**WALL LAMPS APLIQUES**

**BLOW**

CLAUDIO ZAPPONE & GIORGIO PALERMO



REF 64012

**MATERIAL**

Rotational moulded polymer diffusers and brass structure.

**MATERIAL**

Difusor de polimero por rotomoldeo y estructura de latón

**LED**

E27 7W 360° x 2 units

LACQUERED



METALLIC

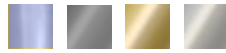

18  
7"

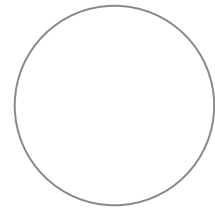

50  
19,7"

**mini BLOW**

CLAUDIO ZAPPONE & GIORGIO PALERMO



REF 63019

**MATERIAL**

Pyrex diffusers and brass structure. Lacquered

**MATERIAL**

Difusor de pyrex y estructura de latón Lacado

**LED**

G9 4W 360° x 1unit

LACQUERED



METALLIC

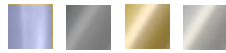

REF 63019B

**MATERIAL**

Pyrex diffusers and brass structure. Metallic Finish

**MATERIAL**

Difusor de pyrex y estructura de latón Acabado Metálico

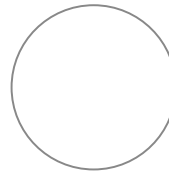

19  
7,5"

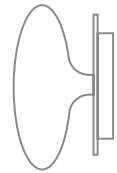

12  
4,7"

**GIRO**

NACHO TIMÓN

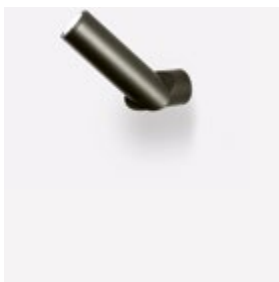

REF 63035

**MATERIAL**

Brass Lacquered

**MATERIAL**

Latón Lacado

**LED**

GU10 8W x 1unit

REF 63035B

**MATERIAL**

Brass Metallic Finish

**MATERIAL**

Latón Acabado Metálico

5  
1,96"

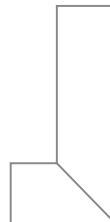

8  
3,15"



17  
6,7"

LACQUERED



METALLIC



**MAYA**  
MERMELADA ESTUDIO



REF 63031

MATERIAL  
Aluminium

MATERIAL  
Aluminio

LED  
E27 12W x 1 unit

LACQUERED

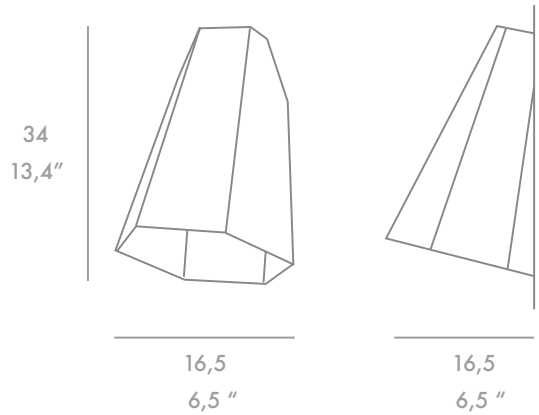

**TRIA**  
LUIS ESLAVA



REF 63021B

MATERIAL  
Steel

MATERIAL  
Acero

LED  
E14 4W x 3 units

REF 63021

MATERIAL  
Steel and textile shades

MATERIAL  
Acero y pantallas textiles

LACQUERED



TEXTILES

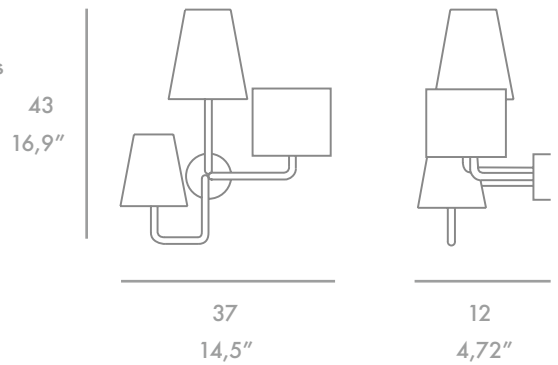

**PENSILIS**  
HERME CISCAR &  
MÓNICA GARCÍA



REF 63026 - 63027 - 63028 - 63029

MATERIAL  
Aluminium

MATERIAL  
Aluminio

LED  
63026 - G9 4W x 1 unit  
63027 - G9 4W x 1 unit  
63028 - 78mm 5W x 1 unit  
63029 - 118mm 10W x 1 unit

LACQUERED

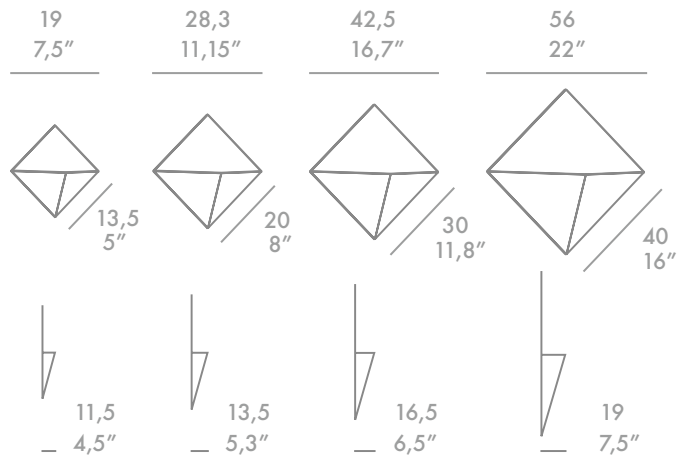



**BLOW**

CLAUDIO ZAPONNE & GIORGIO PALERMO



REF 64012

**MATERIAL**

Rotational moulded polymer diffusers and steel structure.

**MATERIAL**

Difusor de polimero por rotomoldeo y estructura de acero

**LED**

E27 7W 360° x 2 units

LACQUERED



METALLIC



18  
7"

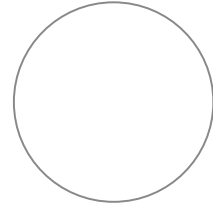

50  
19,7"

**mini BLOW**

CLAUDIO ZAPONNE & GIORGIO PALERMO



REF 63019

**MATERIAL**

Pyrex diffusers and brass structure.

**MATERIAL**

Difusor de pyrex y estructura de latón

**LED**

G9 4W 360° x 1unit

LACQUERED



METALLIC

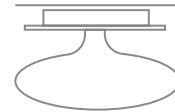

12  
4,7"

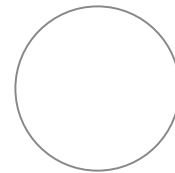

19  
7,5"

**RAINING DAY**

MERMELADA ESTUDIO



REF 64019 - 64020 - 64021

**MATERIAL**

Steel and lycra

**MATERIAL**

Acero y lycra

**LED**

64019 - 7W 360° x 3 units

64020 - 7W 360° x 3 units

64021 - 7W 360° x 8 units

48,5  
19"

72,5  
28,5"

96,5  
38"

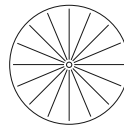

12  
4,7"



64019

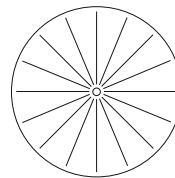

14  
5,5"

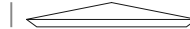

64020

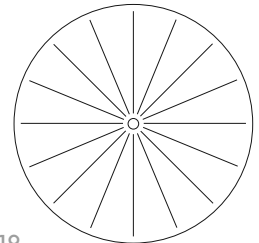

19  
7,5"

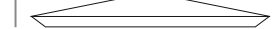

64021

TEXTILES



# FINISHES ACABADOS

## LACQUERED LACADOS

BLACK  
NEGRO



TARDIS BLUE  
AZUL TARDIS



SLATE BLUE  
AZUL PIZARRA



FOG BLUE  
AZUL NIEBLA

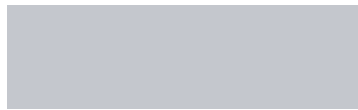

SOFT GREEN  
VERDE SUAVE



STONE WHITE  
BLANCO PIEDRA

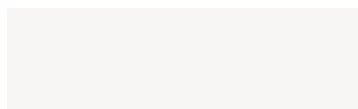

SOFT WHITE  
BLANCO SUAVE



BLUE PASTEL  
AZUL PASTEL



GREY GREEN  
VERDE GRISACEO



ENGLISH GREEN  
VERDE INGLÉS



AUBERGINE  
BERENJENA



BURGUNDY  
BORGOÑA



CORAL PINK  
ROSA CORAL



QUARTZ PINK  
ROSA QUARZO

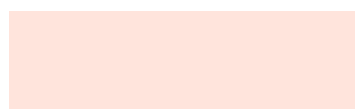

## METALLIC METÁLICOS



**FUME**  
FUMÉ



**CHROME**  
CROMO



**GOLD**  
ORO



**GLAZED NICKEL**  
NIQUEL MATE

## TEXTILES TEXTILES



**BLACK**  
NEGRO



**DARK RED**  
ROJO OSCURO

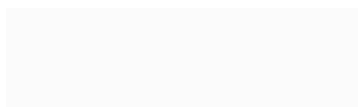

**WHITE**  
BLANCO







[www.almerich.com](http://www.almerich.com)

ALTIMA INNOVA S.L.  
Pol. ind. Fuente del Jarro, apartado de correos 55  
46988 Valencia (Spain)

Nacional: (+34) 96 134 32 30 - [nacional@almerich.com](mailto:nacional@almerich.com)

Export: (+34) 96 134 32 34 - [export@almerich.com](mailto:export@almerich.com)

Art & Creative direction by Arnau Reyna  
Photography by Ángel Segura Foto.

Thanks to SANCAL, PUNT, VICCARBE and CÁRMENES

