

BOS
1964
BARCELONA

The executive
furniture company

CONFERENCE BOOK
REUNIONES BOOK

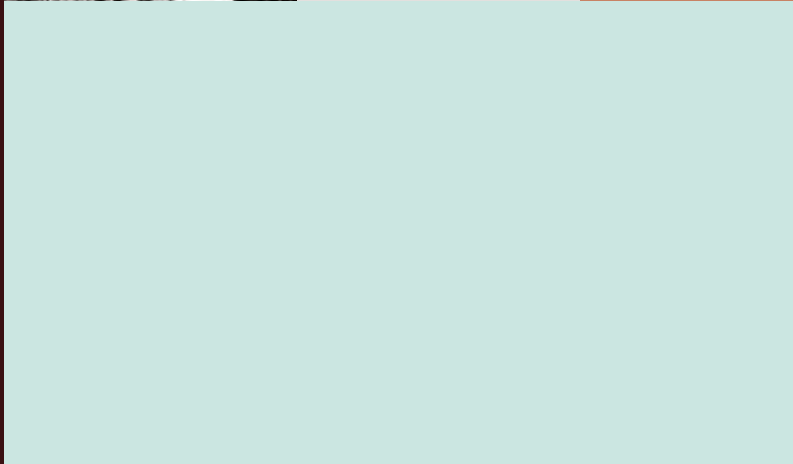

WELCOME TO BOS1964

**We are The Executive Furniture Company
and provide beauty and luxury to the executive floor.**

BIENVENIDO A BOS1964

*Somos la empresa de mobiliario de dirección
que integra diseño y calidad máxima en las áreas
ejecutivas.*

What we do Qué hacemos

We call ourselves The Executive Furniture Company since we are exclusively dedicated to the executive floor. Our products across our 3 areas of expertise are always created with a very high level of finishes. At BOS1964 we take pride in producing the best and most exclusive finishes in natural wood veneers, top Grain European cowhides and piano lacquer finishes. We are very flexible and will generally be able to accommodate any special requests in finishes.

Nos llaman "la empresa de mobiliario de dirección" por nuestra dedicación en exclusiva a las distintas soluciones y necesidades de 3 grandes áreas ejecutivas: mesas de dirección, productos tapizados y mesas de juntas. BOS1964 ofrece una gama de acabados y materiales de máxima calidad en madera, piel, metal, lacas y barnices y una gran flexibilidad de adaptación a las necesidades requeridas en cada proyecto.



- 2) **Upholstered items** with chairs and sofas for the executive office, conference room, VIP area or hotel lobby.
- 2) **Productos tapizados** sillones y sofás para despachos ejecutivos, salas de juntas, zonas VIP o el lobby de un hotel.

- 1) **Executive deskings** for the individual executive office with solutions for chairmen, CEO's, directors and managers.

- 1) **Mesas de dirección** creadas para los despachos de ejecutivos y consejeros delegados.



- 3) **Conference tables** with meeting solutions from a small meeting table for an executive office to a boardroom table with automated screens for a large corporation and available in any shape or size.

- 3) **Mesas de juntas** soluciones que van desde las pequeñas mesas de reunión hasta las grandes mesas de consejo integradas en espacios diversos con una gran variedad de opciones técnicas, informáticas y de sonido según necesidades.





Both have made it. All generations since then have considered their collections to be current and at the forefront in creating contemporary classics.

Ambos lo han conseguido. Todas las generaciones desde esta fecha han considerado siempre actuales sus colecciones que han sido punteras desde los inicios y siguen en primera línea en la actualidad.

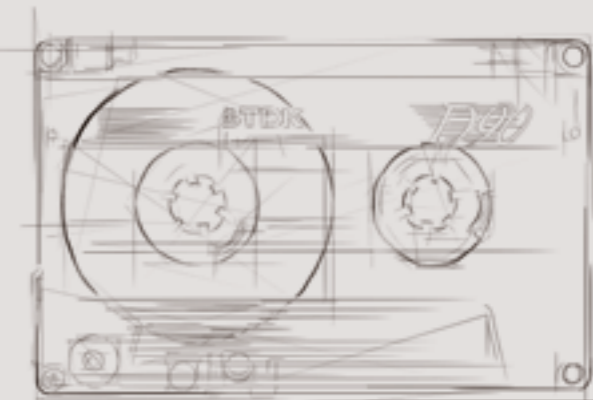
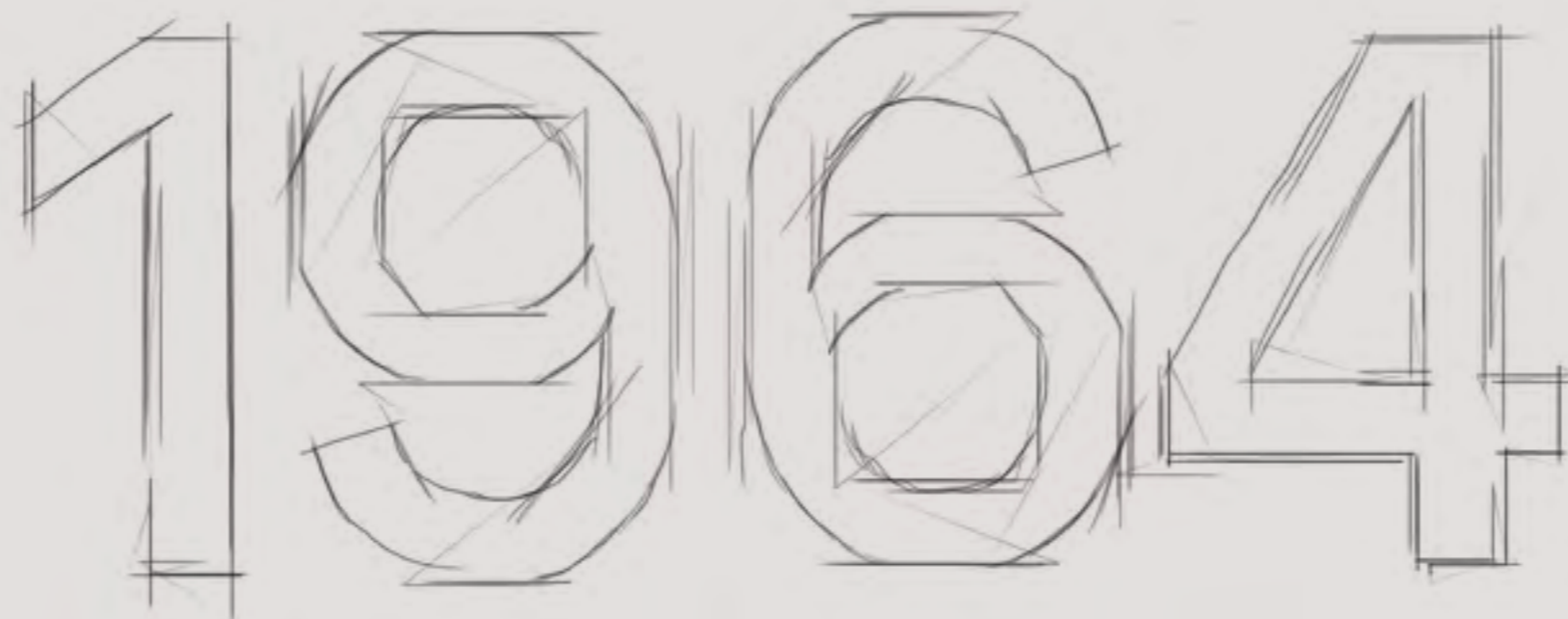

As the cassette revolutionized the world of music, making it possible to listen to your favorite artists anytime and anywhere, BOS1964 has revolutionized the world of top management furniture achieving status as the preferred choice globally.

Como el casete revoluciono el mundo de la música permitiendo escuchar a tus preferidos en cualquier lugar y en cualquier momento BOS1964 ha revolucionado el mundo de mobiliario la alta dirección haciendo que sus productos sean los preferidos en todos los mercados internacionales.

The Olympic spirit is the spirit of BOS1964. International above all. Collections for all countries with capacity to satisfy and combine very diverse aspects that are valid for all continents.

El espíritu de una olimpiada es el espíritu de BOS1964. Internacionalidad por encima de todo. Colecciones para todos los países capaces de satisfacer y conjugar los aspectos más diversos válidos para cualquier continente.



TOKYO 1964

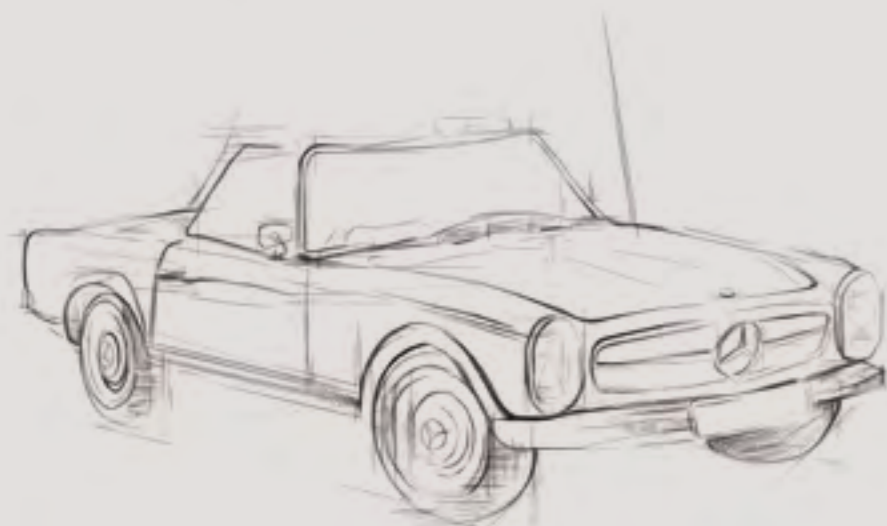

Contemplating products from BOS1964 is like looking at a Mercedes. Prestige, highest quality and long-lasting. An office from BOS1964 is, by its finishes and quality, contemporary and a guarantee of the highest level.

Contemplar los productos de BOS1964 es como contemplar un Mercedes. Prestigio, calidad y perdurabilidad en el tiempo. Un despacho de BOS1964 por sus acabados y calidad siempre es actual y hablar de BOS1964 es hablar de máximo nivel.

Expertise Pericia

Belongs to a limited circle of office furniture manufacturers where product perfection is a core value and a continuous search. Therefore and since its founding, BOS1964 controls all production processes: from purchase and selection of the best natural wood veneers and cow hides to pre-assembly and distribution. We care a lot about our finishes and all our wood veneers are worked by hand and the end product is assigned a unique serial number, which makes tracking easy and guarantees a personalized after sales service. This is part of our total client satisfaction focus.

BOS1964 pertenece a un reducido círculo de fabricantes muebles que, fiel a sus valores, busca la perfección de sus productos. Por ello, y desde que se fundó la firma, BOS1964 controla todos los procesos de producción: desde la compra y selección directa de las mejores maderas y pieles hasta su montaje previo y distribución. Con un cuidado estricto de los acabados, todas las maderas se trabajan a mano y el producto final siempre lleva un número de serie para hacer un seguimiento del mismo y ofrecer un servicio de posventa personalizado que garantice la total satisfacción de nuestros clientes.



UNE-EN ISO
9001:2015

UNE-EN ISO
14001:2015

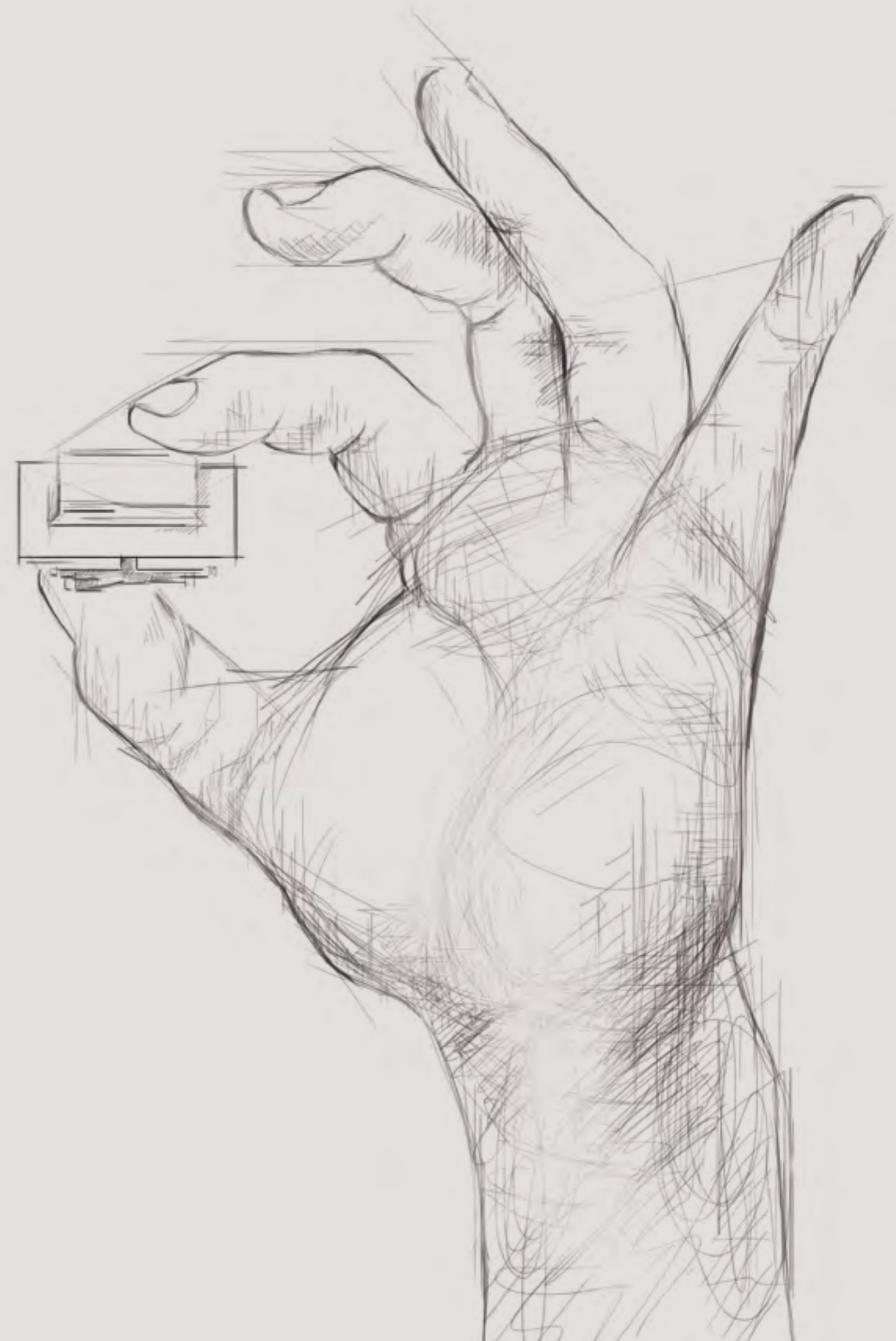

Designers Diseñadores

One of our main objectives is to find a perfect balance between classic and modern designs that ensures durability as well as icons in terms of handcraft and innovation. This is achieved thanks to our dynamic multicultural team which, by combining top-notch technology and strong expertise in traditional manufacturing, is able to provide unique and exclusive solutions to meet the needs of our most demanding clients. Our ambition to maintain leadership in executive office furniture drives us to continually innovate in providing highly resilient furniture of supreme quality.

Uno de los principales objetivos es encontrar el equilibrio perfecto entre el clasicismo y la modernidad para que nuestros productos perduren con el paso del tiempo y se conviertan en un icono de artesanía e innovación. Esto se consigue gracias a un equipo dinámico y multicultural que, combinando la tecnología de última generación con los conocimientos de la manufactura tradicional, puede seguir ofreciendo soluciones exclusivas y únicas a la altura de las necesidades más exigentes. Nuestra ambición por ser un referente en mesas de despacho, mesas de reuniones y sillas de dirección es lo que nos inspira para seguir innovando y ofrecer muebles con una durabilidad y calidad suprema.



Sørig

Is born in Denmark and develops his professional activity as "Industrial designer". Starts his studies at "Kunstakademiets Arkitektkskole" and at the "Aarhus school of architecture" building his own business in 1995 "Sorig Designstudio". Works for different sectors and known brands such as Bang&Olufsen and Swarovski, gaining different prices such as IF Cebit Award 1995, Las Vegas Best of show, 2000.

Nace en Dinamarca y desarrolla su actividad profesional como "diseñador industrial". Empieza su formación en "Kunstakademiets Arkitektkskole" y en la "Aarhus school of architecture" montando su propio estudio en 1995 "Sorig Designstudio". Trabaja para distintos sectores destacadas y marcas como Bang&Olufsen y Swarovski, cosechando diversos premios como IF Cebit Award 1995, Las Vegas Best of show, 2000.



Arola

Born in Tarragona in 1960 and starts his professional career at the studio "Lievore y Pensi" and later at "AD Associate Designers". He starts his own studio in 1994 "Estudio Arola" In parallel with his business he also gives classes at the university. Has won several prices Silver Delta Price, 1999 and 2001, National design price, 2003, Price I Plus, 2009, Reddot award, 2012 and is honorable member of the design organization APPI.

Nace en Tarragona en 1960 e inicia su carrera profesional en el estudio "Lievore y Pensi" y posteriormente en "AD Associate Designers" fundando su propio estudio en 1994 "Estudio Arola". Compagina su carrera profesional con la docencia y ha cosechado diversos premios. Premio Delta de plata 1999 y 2001, Premios nacional de diseño en 2003, Premio I Plus 2009, Red Dot Award 2012 y nombrado "soci d' honor APPI".



Pensi

Leaves his natal country Argentina in 1975 and establishes himself in Barcelona in 1984 and creates "Jorge Pensi Design Studio". Jorge Pensi has given conferences and workshops all around the world. He and his designs have received several prizes among which is the Spanish design price in 1997.

Deja su país de origen Argentina en 1975, se establece en Barcelona en 1984 y crea su propio studio "Jorge Pensi Design Studio" Jorge Pensi ha dictado conferencias, seminarios y workshops en distintos lugares del mundo. Él y sus productos han cosechado diversos premios, entre ellos el premio nacional de diseño en 1997 en España.



Danesi

Is an Italian designer born in Bolzano in 1948. Starts his career at the architect studio "Baniera e Facchini" and concentrates his activity mainly in Office furniture projects. He starts his own business in 1980 as product designer and art director as well as consultant for international companies in the office sector.

Es un diseñador Italiano nacido en Bolzano en 1948. Empieza su carrera profesional en el estudio de los arquitectos "Bandiera e Facchini" y centra su actividad primordialmente en los proyectos de sistemas de oficina. Funda su propio estudio en 1980 como product designer, art director y asesor para empresas del sector de oficinas, italianas y extranjeras.



BOS Barcelona Design Team

BOS Barcelona Design Team is made up of designers and Project developers with accumulated experience far beyond their own, as they continue a design tradition that dates back to 1939. This is the BOS1964 design cradle from which accumulated knowledge has made possible the products that BOS1964 offers today.

BOS Barcelona Design Team es un equipo de diseñadores y proyectistas que ostentan una dilatada experiencia muy superior a la de su propia existencia como continuadores de grandes equipos de diseño del pasado existentes desde 1939 de cuya enseñanza se han beneficiado consiguiendo los productos que BOS1964 ofrece en la actualidad.

International *Internacional*

An international focus has always been a top priority for BOS1964, with a long track record of more than 30 years exporting to more than 40 countries worldwide, continuously growing in our effort to reach new markets.

La vocación internacional siempre ha sido la máxima a seguir de los responsables de BOS1964; con una experiencia dilatada en este ámbito, en la actualidad BOS1964 tiene incidencia en más de 40 países y continúa trabajando incesantemente para abrir nuevos mercados.

Dubai
Dubai

Cairo
El Cairo

Brussels
Bruselas

Doha
Doha

Bahrain
Baréin

Kuwait
Kuwait

Muscat
Mascát

Moscow
Moscú

St. Petersburg
St. Petersburgo

Warsaw
Varsovia

Barcelona
Barcelona

Lisbon
Lisboa

Astana
Astaná

Geneva
Ginebra

Almaty
Almaty

Sofia
Sofía

Athens
Atenas

Luxemburg
Luxemburgo



Touring
16

01

Diktat
32

02

Titanium
90

05

Oxford
106

06

BCN
48

03

Chairs
Sillas
116

07

Bookcases
Librerías
124

08

Sixty
76

04

Technology
Tecnología
132

09



A

S

T

B L

E

BOS1964
18 - 19

Tables
Mesas

Touring
Diktat
Bcn

Sixty
Titanium
Oxford

Our most presidential collection
Nuestra colección más presidencial

Design / Diseño:
Danesi

Touring

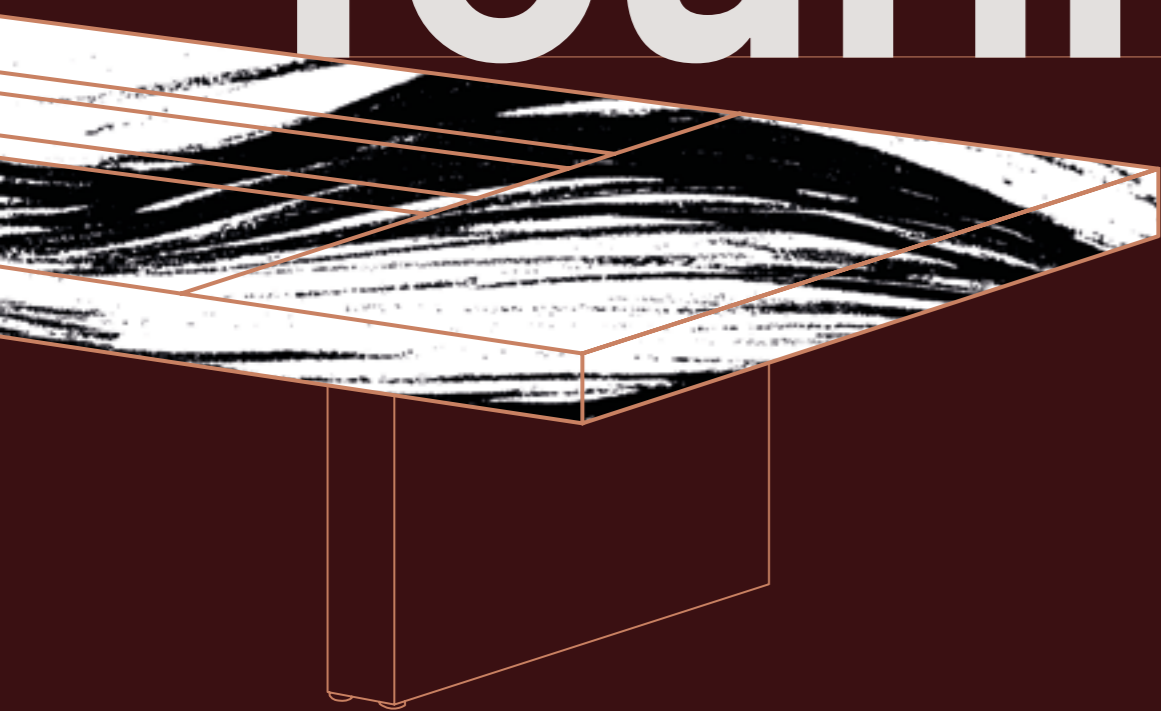

BOS
1964
BARCELONA





Ebony makassar wood
RAL 8023 piano lacquer
5600x1800





RAL 7039 matt lacquer
Leather Fusion 912
RAL 7024 matt lacquer
4200x1400



American Walnut wood high gloss
Leather Fusion 925
RAL 8017 piano lacquer
9800x2000
h 750/950

BOS1964
28 - 29

Tables
Metas

Touring
Diklat
Bcn

Sixty
Titanium
Oxford



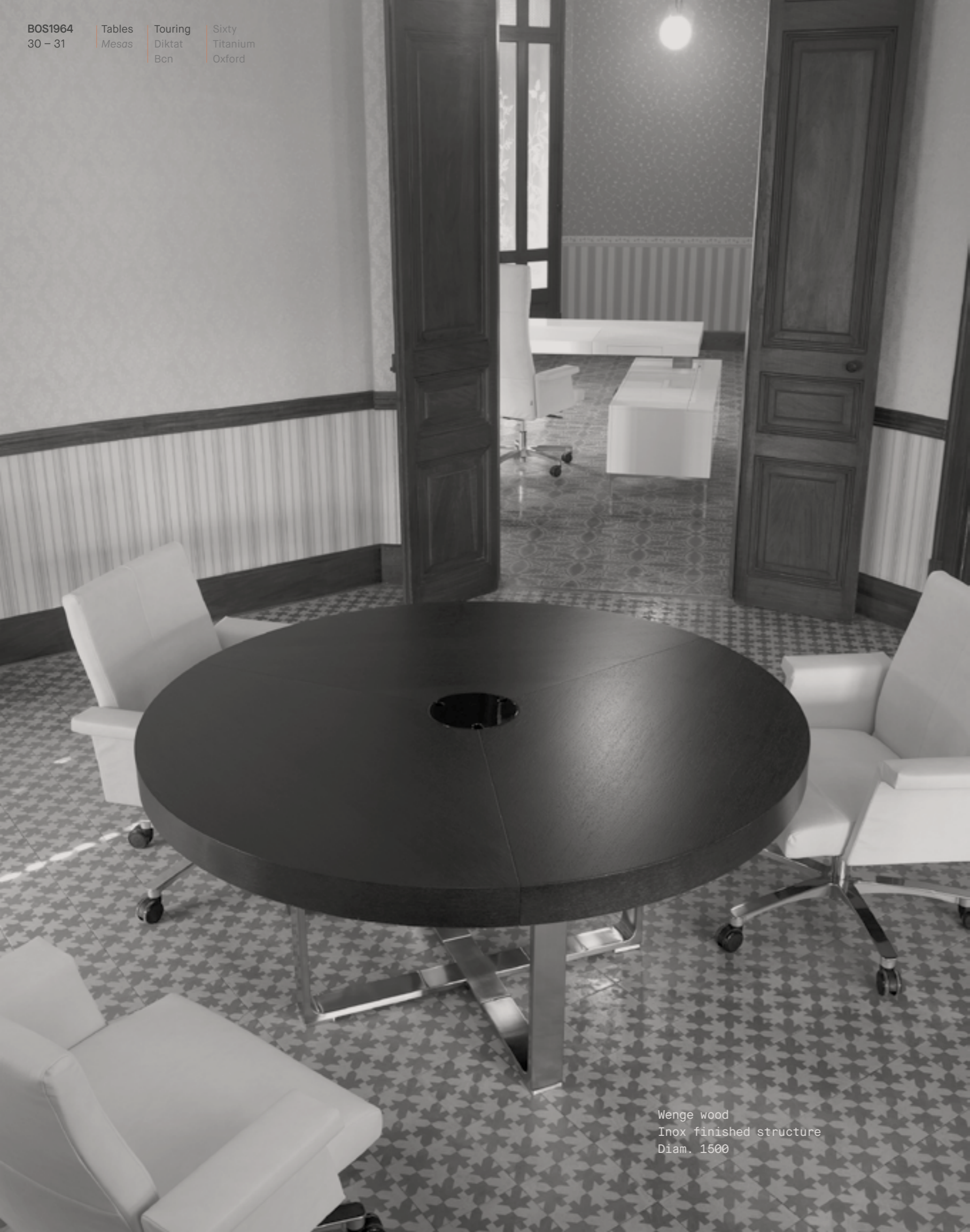

Wenge wood
Inox finished structure
Diam. 1500



Intercontinental Hotel
Egypt



American walnut wood
Black piano lacquer
2800x1400

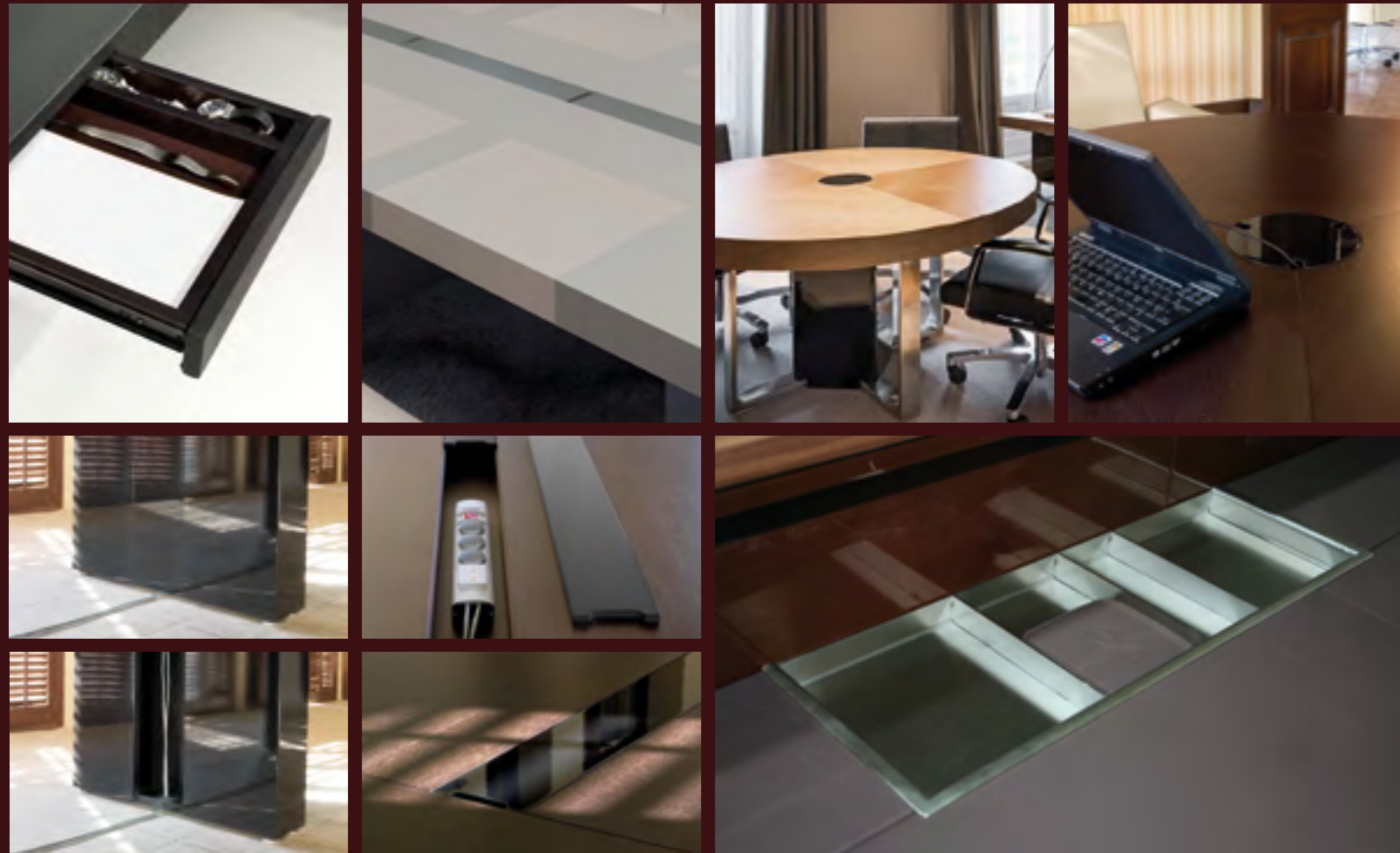

TECHNICAL INFORMATION
INFORMACIÓN TÉCNICA

Table top
Sobre

Thickness
Grosor



85

Shape
Forma

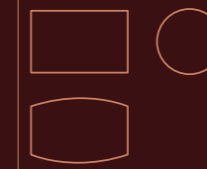

Finishes
Acabados

Wood / *Madera*
Lacquer / *Lacado*
Leather / *Piel*

Structure
Estructura

Shapes
Formas



140

Finishes
Acabados

Wood / *Madera*
Lacquer / *Lacado*

Dimensions in mm and capacity
Dimensiones en mm y capacidad

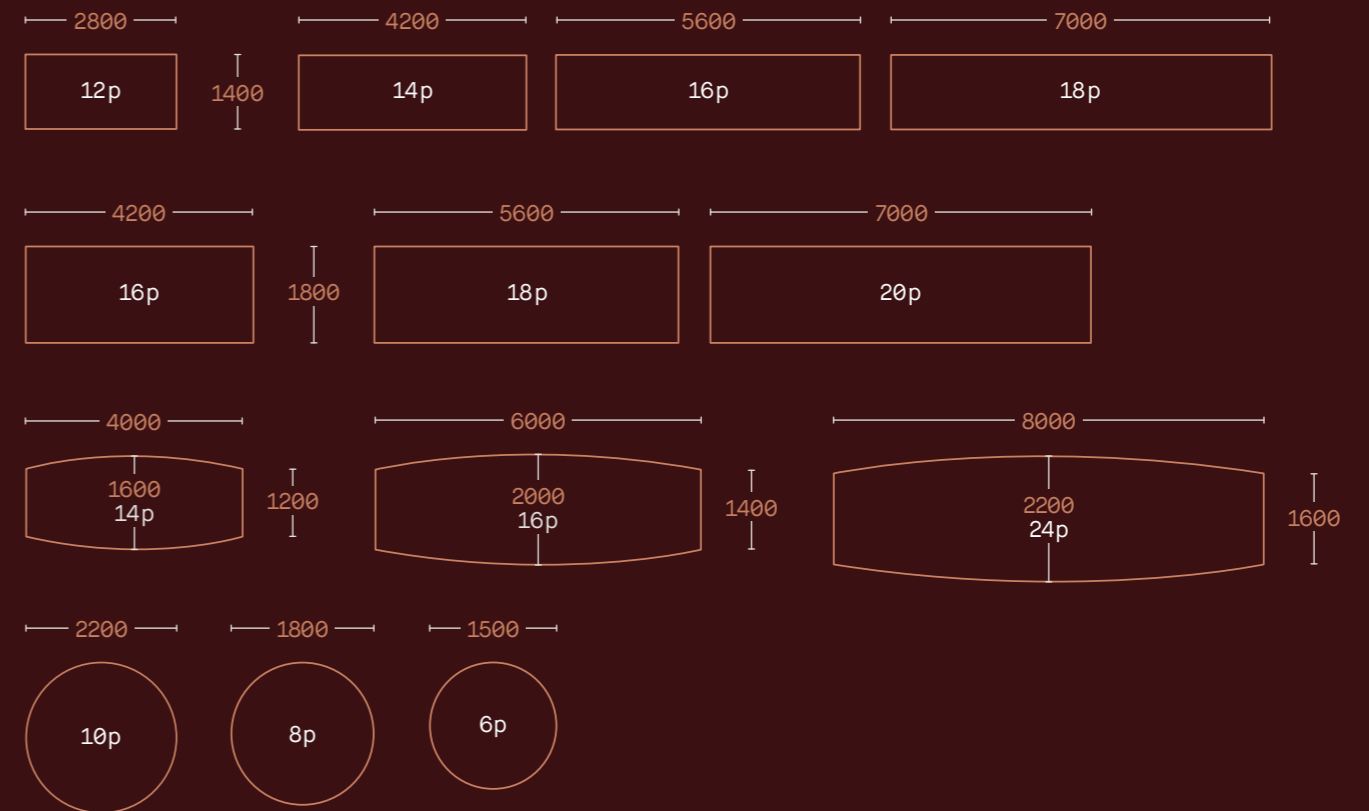

BOS1964
34 - 35

Tables
Mesas

Touring
Diktat
Bcn

Sixty
Titanium
Oxford

Amazing combinations of all our high end finishes
Perfecta combinación de acabados de máxima calidad

Design / Diseño:
Danesi

Diktat

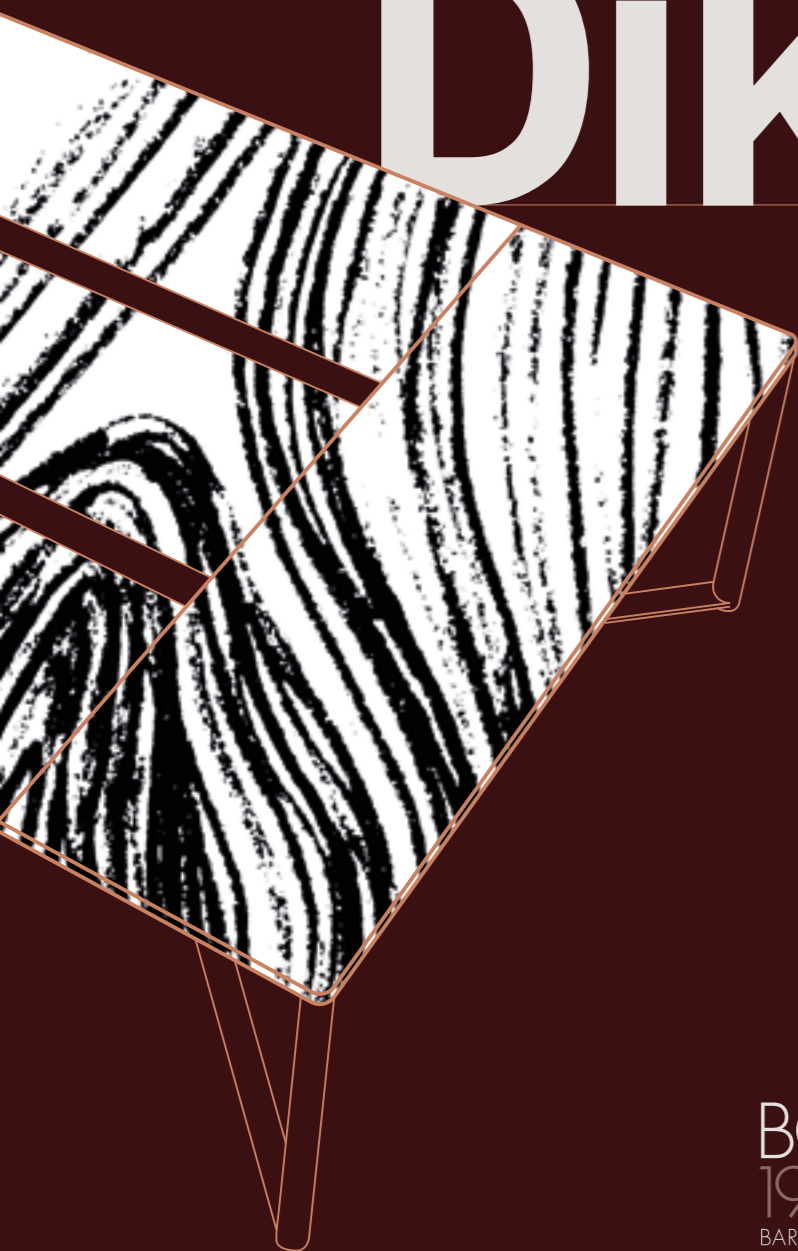

BOS
1964
BARCELONA



Leather Fusion 925
American Walnut wood
Black shiny structure
5200x1800



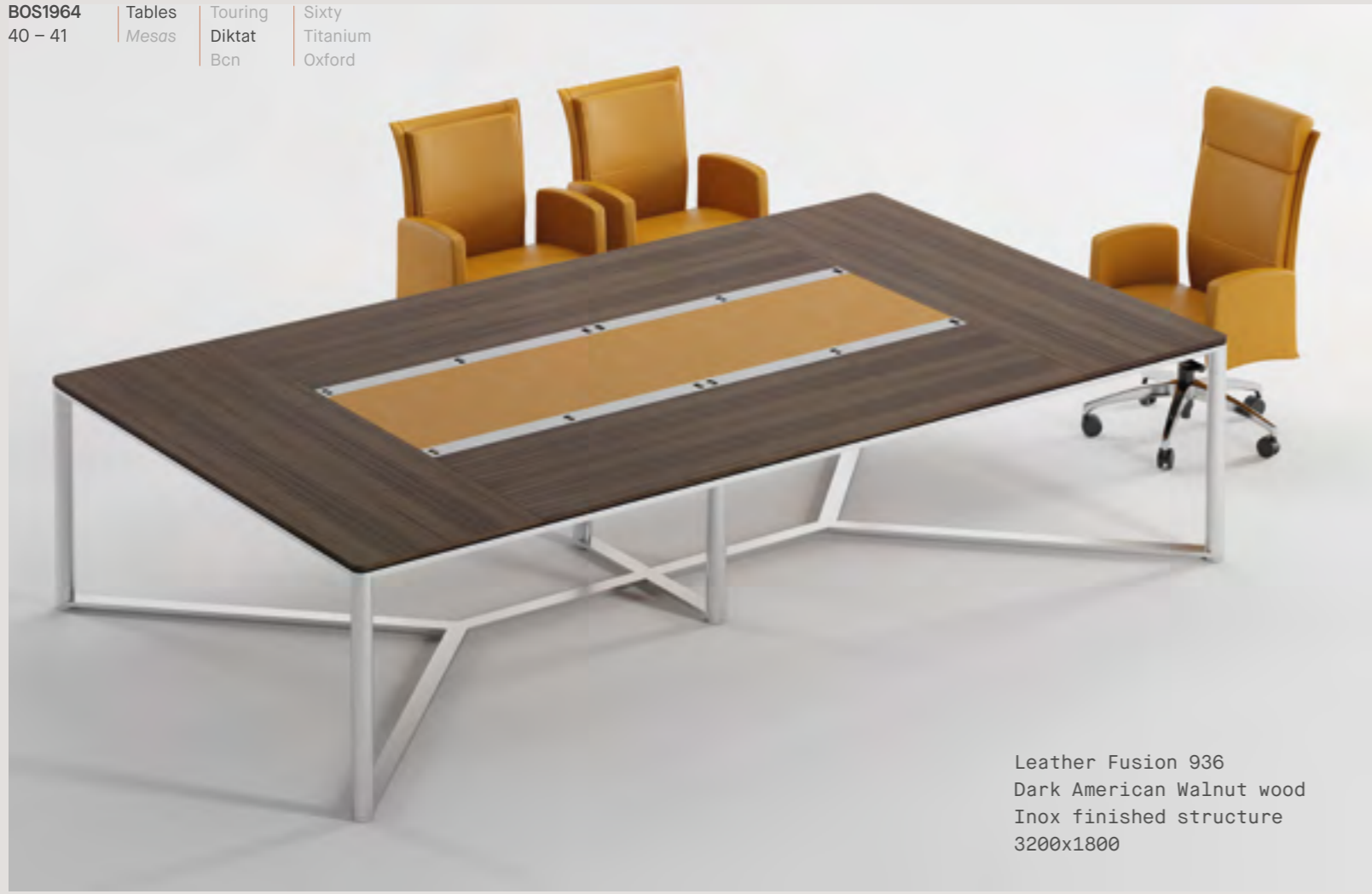

Leather Fusion 936
Dark American Walnut wood
Inox finished structure
3200x1800



Leather Fusion 936
Inox finished structure



Dark American Walnut wood
Inox finished structure



Black matt lacquer
Transparent glass
Black shiny structure
3200x1800



Transparent glass
RAL 7024 matt lacquer
Black shiny structure



Transparent glass
White lacquer
White shiny structure



North American maple wood
Inox finished structure
3200x1200



Dark American walnut wood
Inox finished structure
3200x1200



Transparent glass
Inox finished structure
3200x1200



Black ash wood
Inox finished structure
1800x1800



TECHNICAL INFORMATION
INFORMACIÓN TÉCNICA

Table top
Sobre

Thickness
Grosor

19+19

Shape
Forma

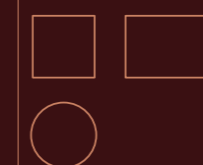

Finishes
Acabados

Wood / *Madera*
Lacquer / *Lacado*
Glass / *Cristal*
Leather / *Piel*

Structure
Estructura

Shapes
Formas

Ø50

Finishes
Acabados

Inox / *Inoxidable*
Bright paint / *Pintura brillante*

Dimensions in mm and capacity
Dimensiones en mm y capacidad

1800

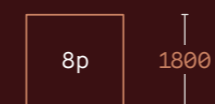

2200

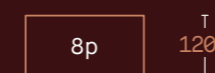

3200

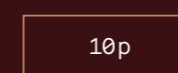

4200

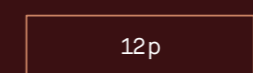

5200

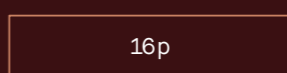

3200

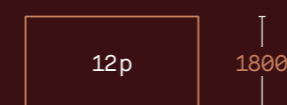

4200

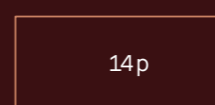

5200

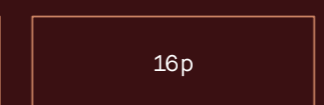

6200



7200

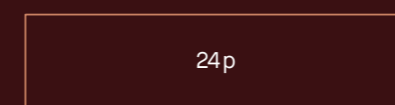

8200

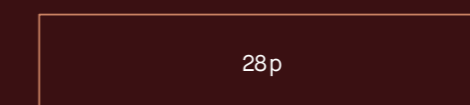

9200



1300

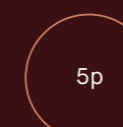

Customize tables upon request / *Mesas a medida bajo demanda*

Very versatile and spectacular
Versátil y espectacular

Design / Diseño:
BOS.DT

BCN









Black marble
Stainless steel
Leather Fusion 915
RAL 7003 matt lacquer
10000x3000/1500



White Piano Lacquer
Leather Fusion 951
Black matt lacquer
8000x2800

BOS1964
60 - 61

Tables	Touring	Sixty
Mesqs	Diktat	Titanium
	Bcn	Oxford



RAL 6021 piano lacquer
Stainless steel
Leather Fusion 915
8000x2400/1800

BOS1964
62 - 63

*Tables
Mesas

Touring
Diktat
Bcn

Sixty
Titanium
Oxford





RAL 1019 piano lacquer
RAL 9006 piano lacquer
Leather Fusion 916
7500x4000



Leather Fusion 929
Ebony makassar
RAL 1019 matt lacquer
7000x2200/1600



Cherry wood high gloss
Leather Fusion 902
Diam: 8400





American Walnut wood
Leather Fusion 932
RAL1019 matt lacquer
7300x4200/2200



Leather Fusion 937
Ebony Makassar
2750x1100



Black leather
Dark American walnut wood
RAL 7024 matt lacquer
1800x1800



Family Investment Office
Kingdom of Saudi Arabia

Leather Fusion 916
American walnut wood
RAL 7024 matt lacquer
4250x1100

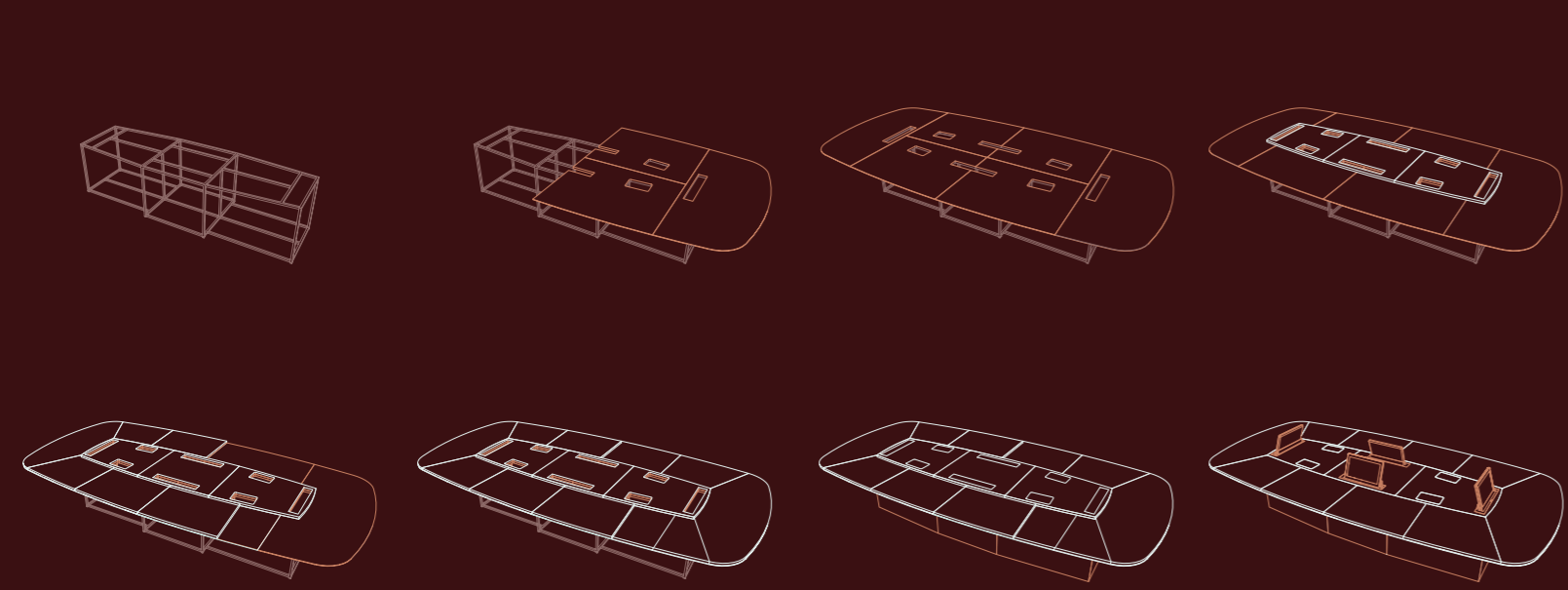
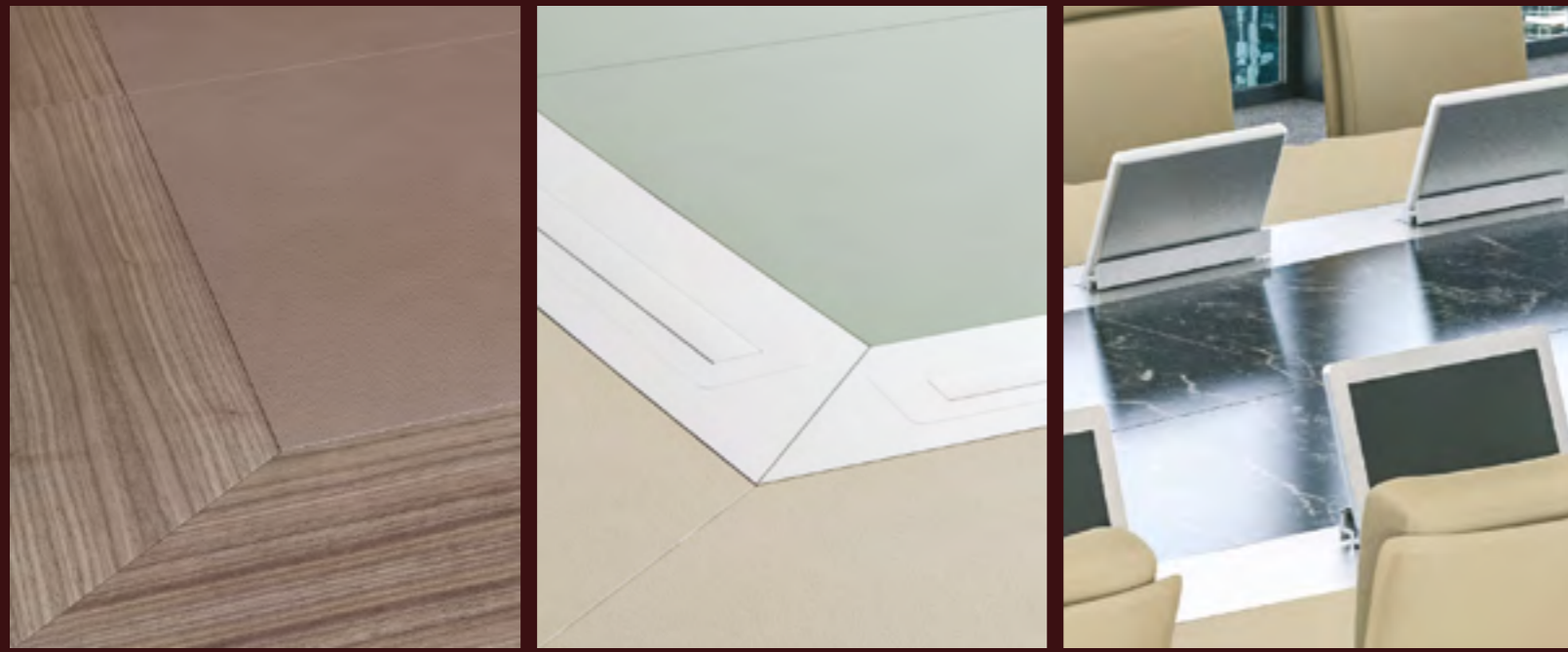

TECHNICAL INFORMATION
INFORMACIÓN TÉCNICA

Table top
Sobre

Thickness
Grosor



Shape
Forma

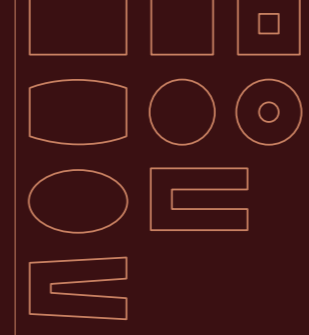

Finishes
Acabados

- Wood / *Madera*
- Lacquer / *Lacado*
- Glass / *Cristal*
- Leather / *Piel*
- Marble / *Mármol*
- Metallic / *Metálico*

Structure
Estructura

Shapes
Formas

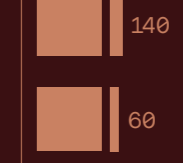

Finishes
Acabados

- Wood / *Madera*
- Lacquer / *Lacado*

Dimensions in mm and capacity
Dimensiones en mm y capacidad

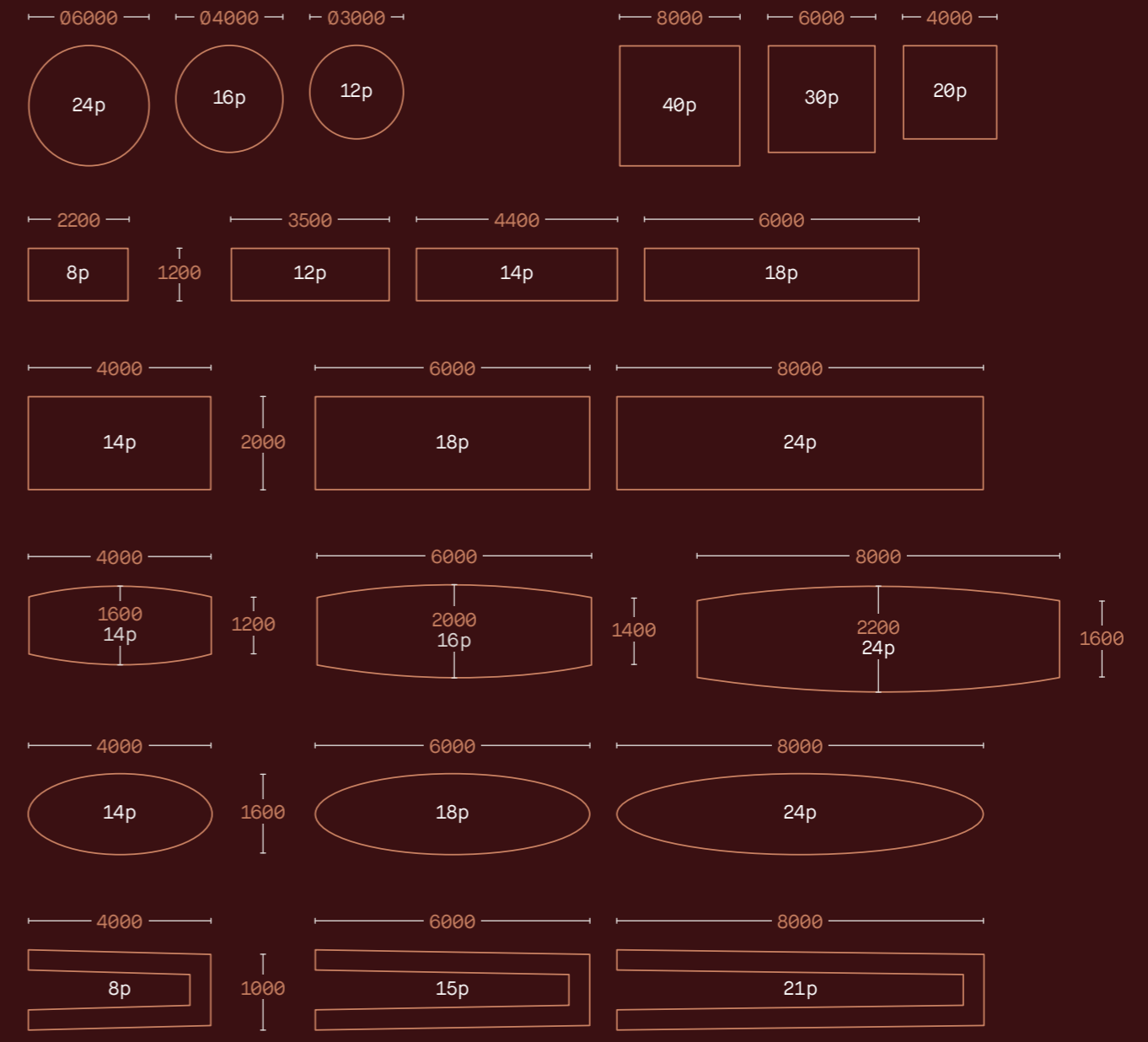

Customize tables upon request / *Mesas a medida bajo demanda*

BOS1964
78 - 79

Tables
Mesas

Touring
Diktat
Bcn

Sixty
Titanium
Oxford

Solid and impressive
Sólida e impactante

Design / *Diseño*:
Danesi / Arola

Sixty



BOS
1964
BARCELONA



Black matt lacquer
American walnut wood
3500x1200



Black ash wood
White matt lacquer
1200x1200

BOS1964
84 - 85

Tables
Mesas

Touring
Diktat
Bcn

Sixty
Titanium
Oxford



American Walnut
Black piano lacquer
Stainless steel
2400x2400



Leather Fusion 912
RAL 9006 piano lacquer
RAL 7024 matt lacquer
5000x1600



Ebony makassar wood
Black piano lacquer
3500x1200

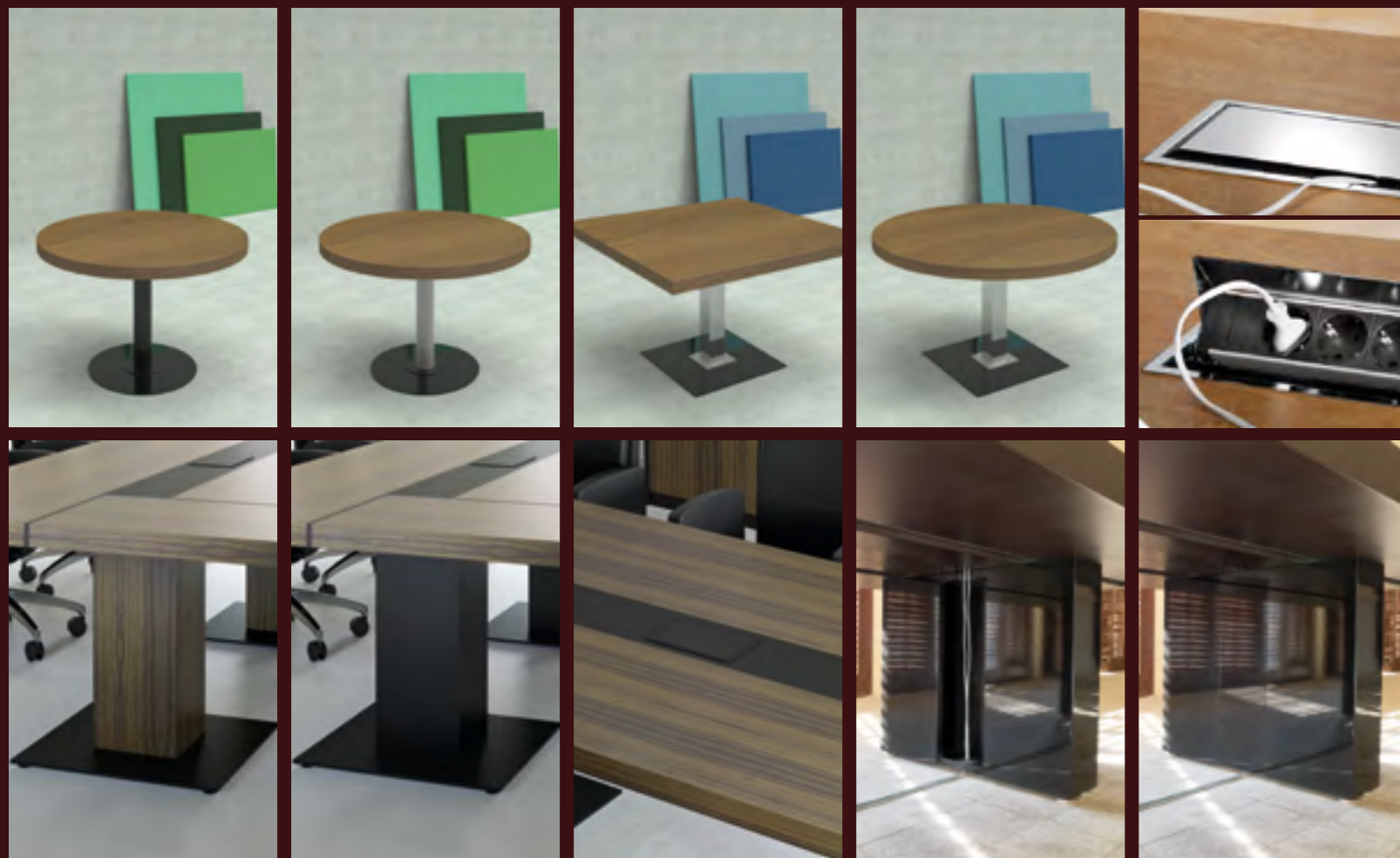

TECHNICAL INFORMATION
INFORMACIÓN TÉCNICA

Table top
Sobre

Thickness
Grosor



60

Shape
Forma

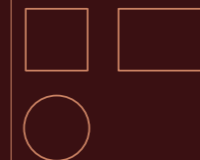

Finishes
Acabados

Wood / Madera
Lacquer / Lacado

Structure
Estructura

Shapes
Formas



60

□ 250

□ 700

Finishes
Acabados

Wood / Madera
Lacquer / Lacado

Dimensions in mm and capacity
Dimensiones en mm y capacidad

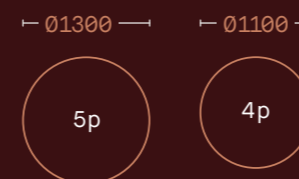
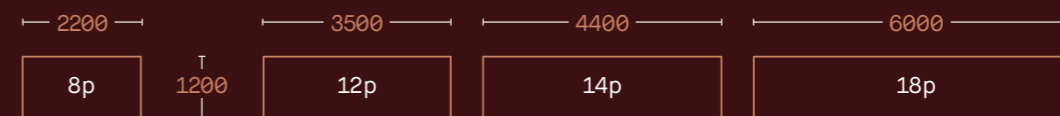

BOS1964
92 - 93

Tables
Mesas

Touring
Diktat
Bcn

Sixty
Titanium
Oxford

Light and Scandinavian
Lineas minimalistas

Design / Diseño:
Danesi / BOS.DT

Titanium



BOS
1964
BARCELONA



Black matt lacquer
Chromed structure
Diam: 6000





RAL 9006 piano lacquer
Dark American Walnut
Chromed structure
4500x1500



American walnut
Chromed structure
3500x1200



Dark American walnut
Chromed structure
2500x1000



Wenge wood
Chromed structure
4500x1200



TECHNICAL INFORMATION
INFORMACIÓN TÉCNICA

Table top
Sobre

Thickness
Grosor

	16+16
	25/30
	25/30

Shape
Forma

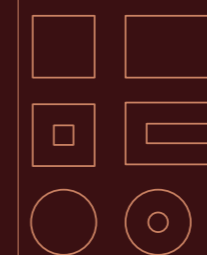

Finishes
Acabados

Wood / Madera
Lacquer / Lacado

Structure
Estructura

Shapes
Formas

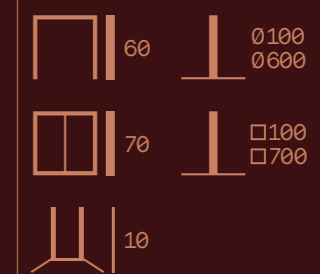

Finishes
Acabados

Metallic / Metálico
Paint / Pintado
Lacquer / Lacado

Dimensions in mm and capacity
Dimensiones en mm y capacidad

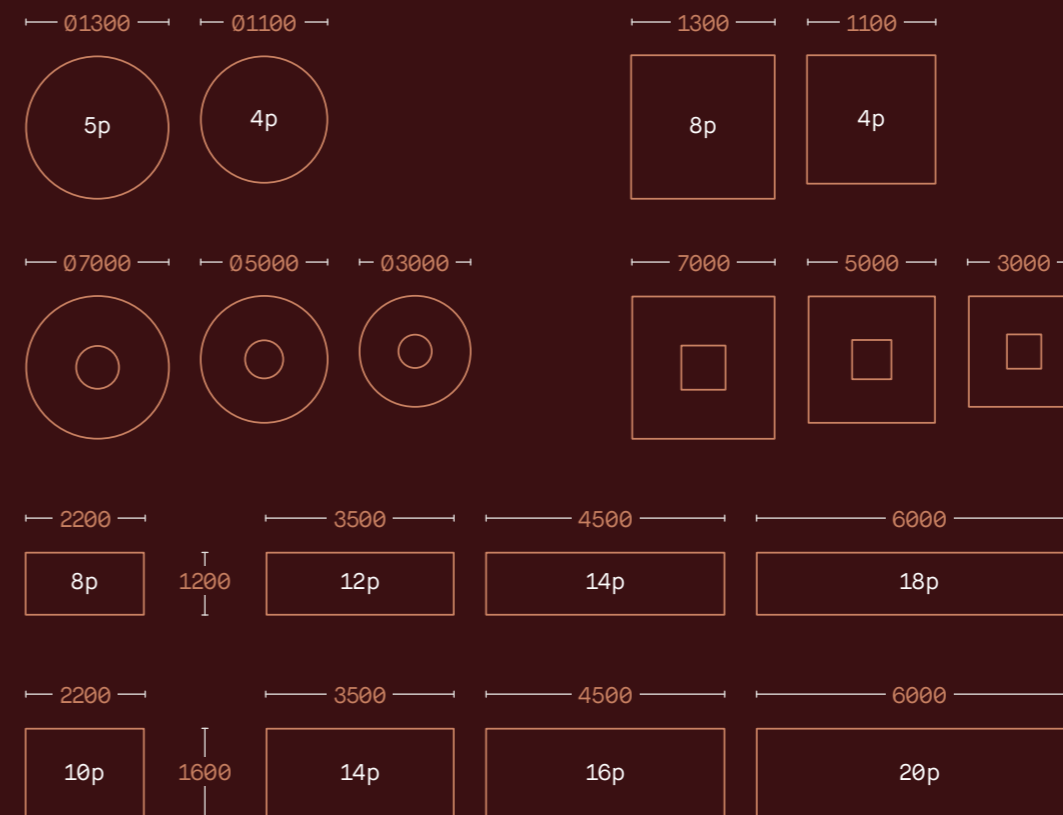

BOS1964
108 - 109

Tables
Mesas

Touring
Diktat
Bcn

Sixty
Titanium
Oxford

Classic and contemporary
Clásico y contemporáneo

Design / Diseño:
BOS.DT

Oxford



BOS
1964
BARCELONA



Dark American Walnut
Black matt lacquer
6000x2400/1800



Dark American Walnut
Black matt lacquer
Diam: 2500





TECHNICAL INFORMATION
INFORMACIÓN TÉCNICA

Table top
Sobre

Thickness
Grosor



Shape
Forma



Finishes
Acabados

Wood / *Madera*
Lacquer / *Lacado*

Structure
Estructura

Shapes
Formas



Finishes
Acabados

Wood / *Madera*
Lacquer / *Lacado*

Dimensions in mm and capacity
Dimensiones en mm y capacidad

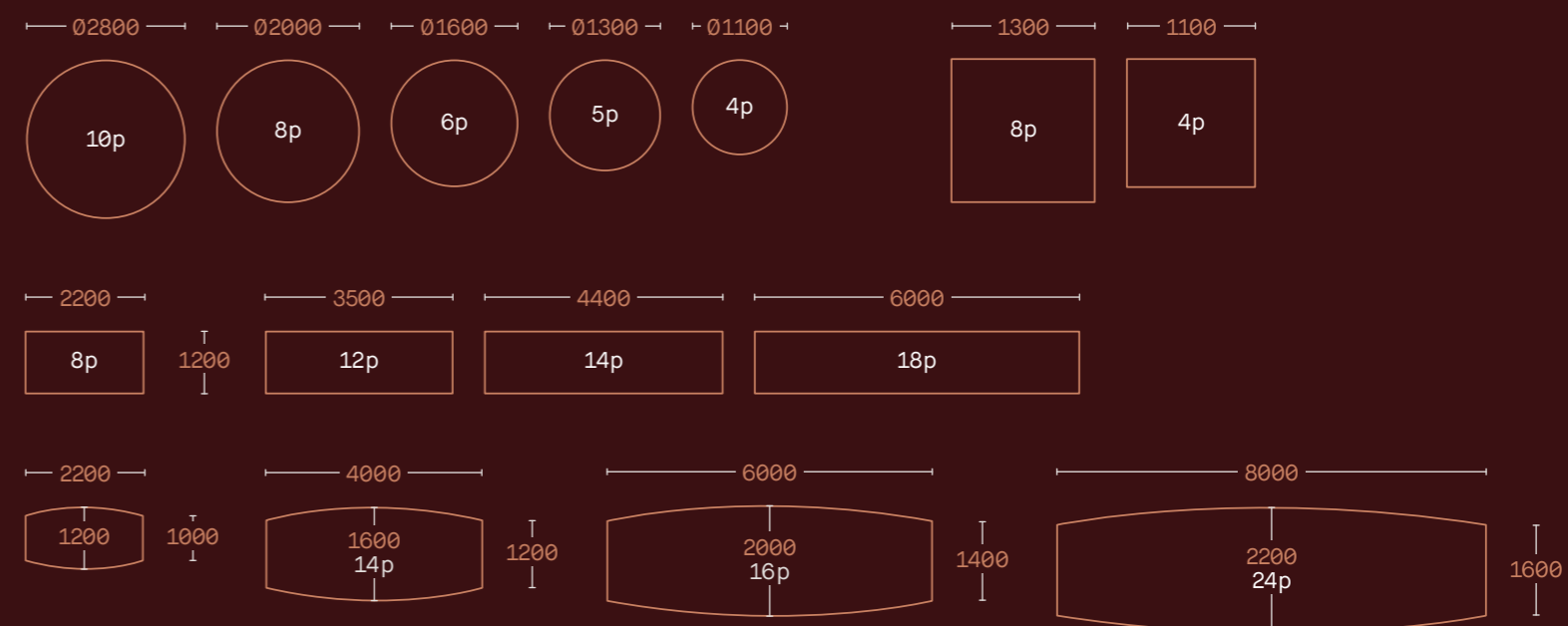

Chairs
Sillas

C

H

A

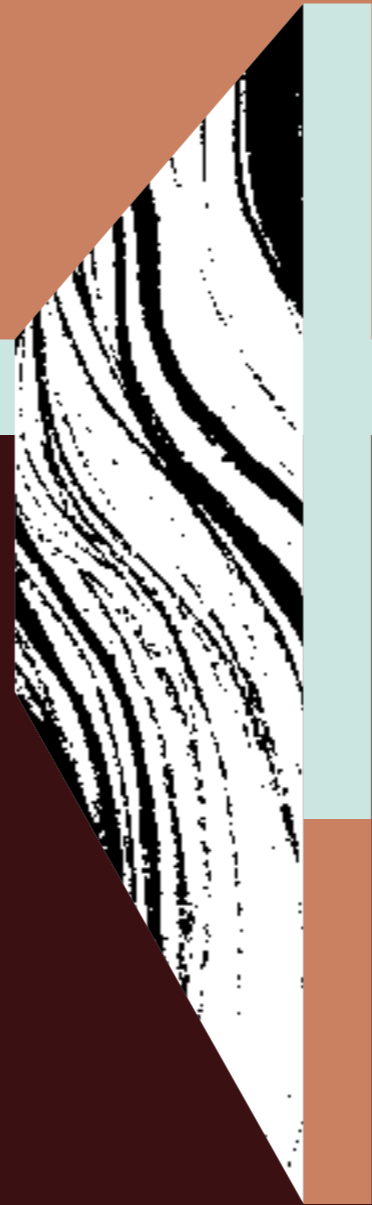

R



S

Musa



Lauro



Dea



Vela



Lina



Lauro



Musa



Dea



Vela



Dina



Aranda



Musa

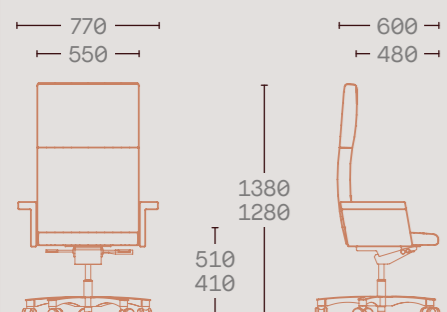
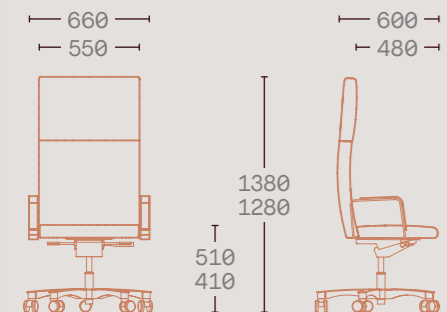
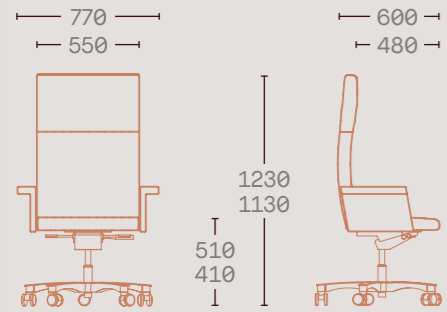
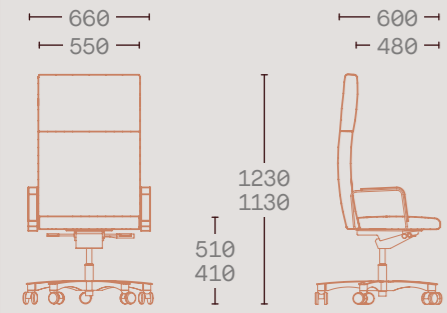
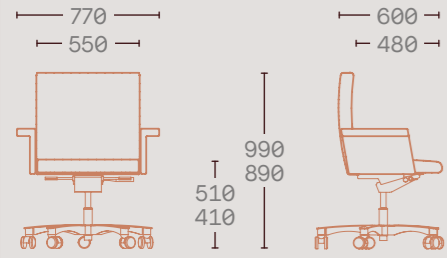
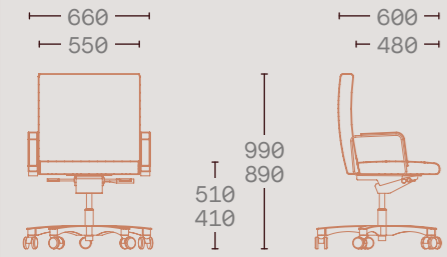

Lauro

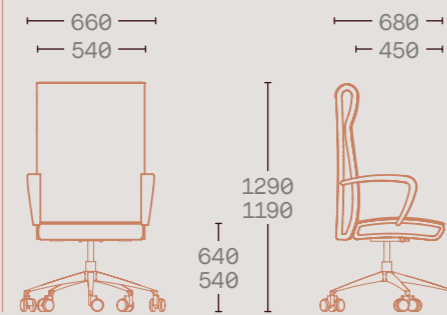
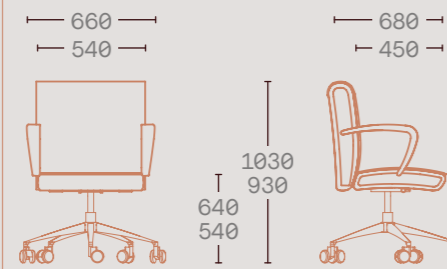
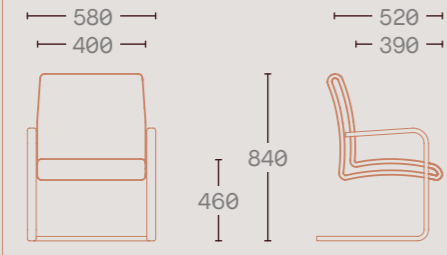

Dea

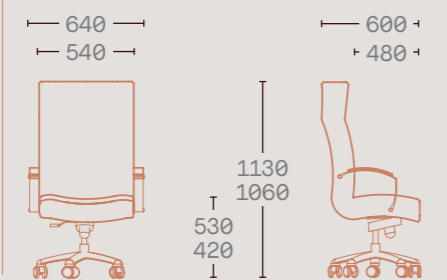
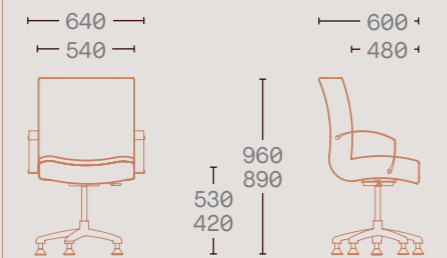
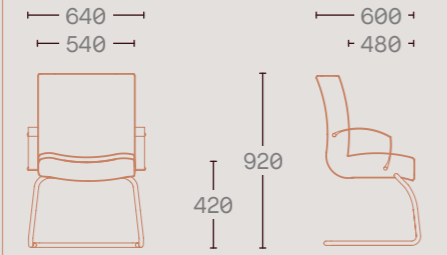

Aranda

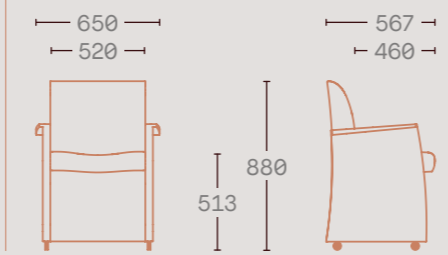

Lina

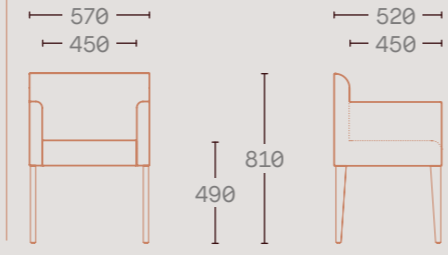

Dina

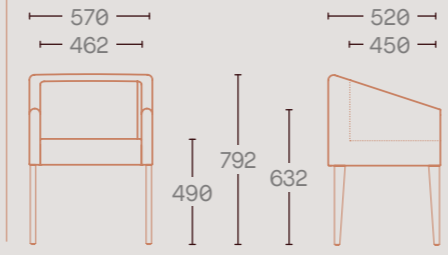

Vela

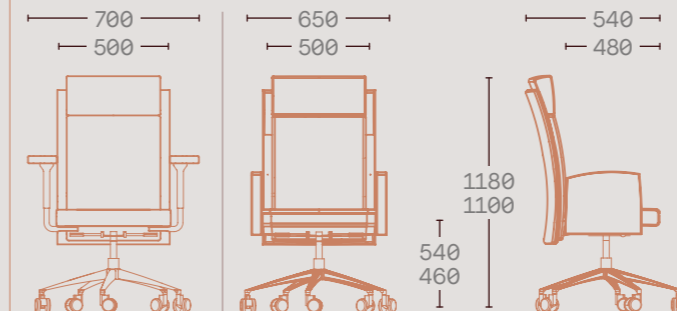
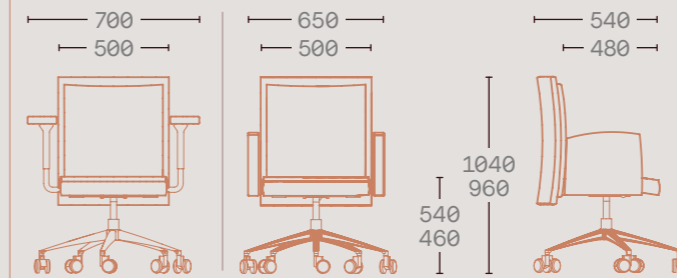
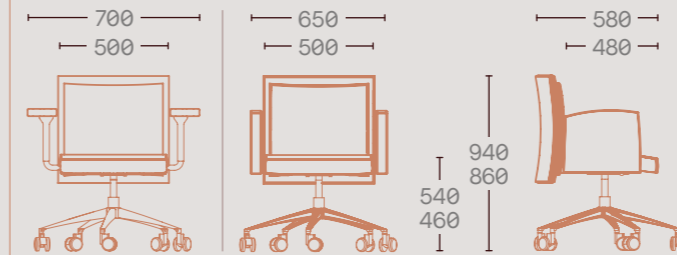
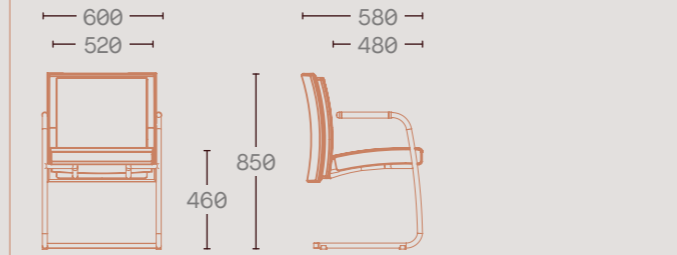

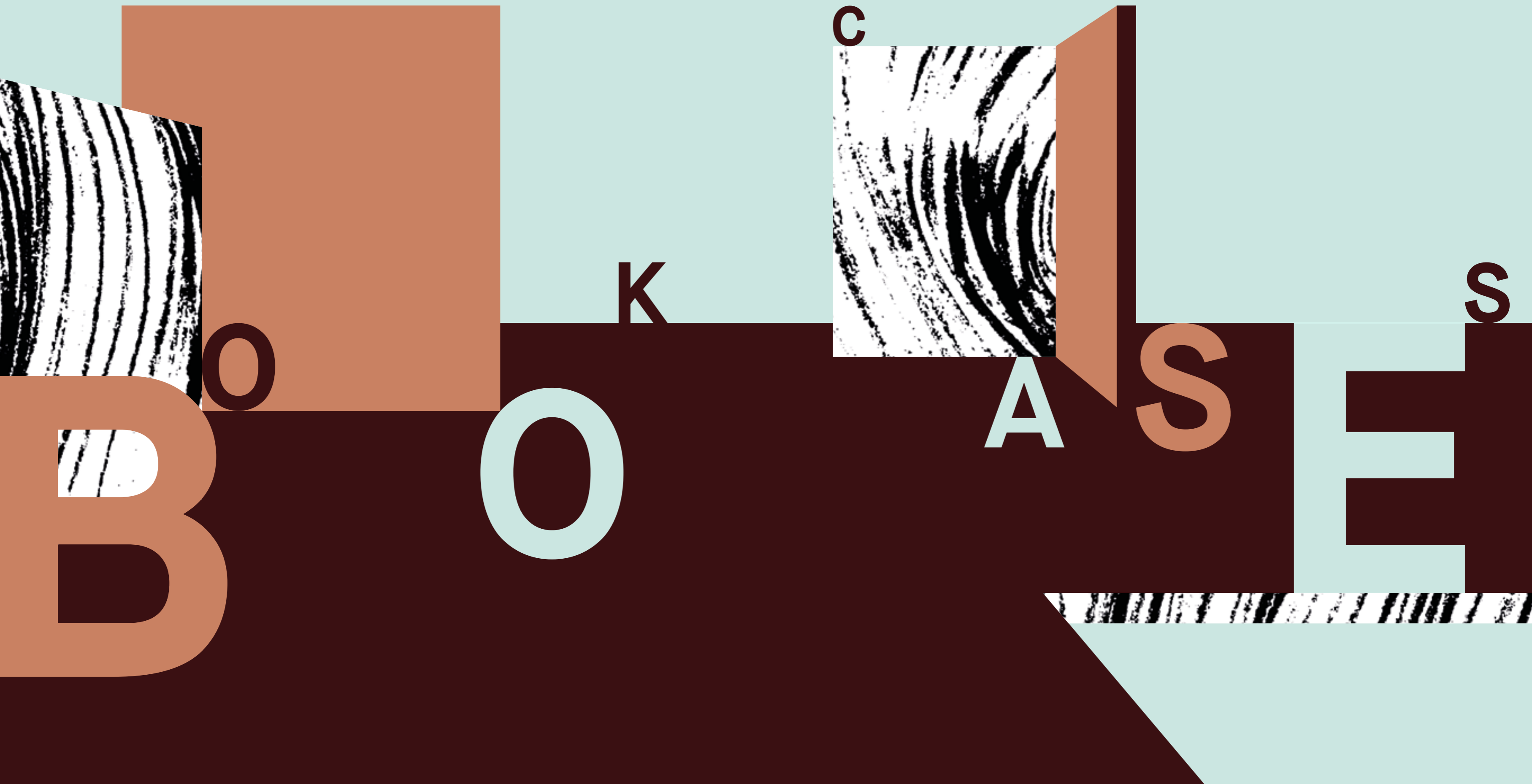

Luxury bookcases Librerías 'Luxury'

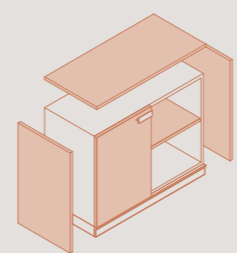

● Wood/Madera
○ Lacquered/Lacado



1840x460
h 736



2290x460
h 736



2740x460
h 736



1840x460
h 1376



2740x460
h 1376



2290x460
h 2016



2740x460
h 2016

Recommended with: Touring, Diktat, BCN and Sixty
Recomendaciones junto a: Touring, Diktat, BCN y Sixty



CUSTOMIZED WALL UNIT WITH MIRROR TV
MUEBLE A MEDIDA CON ESPEJO CON TELEVISOR INTEGRADO

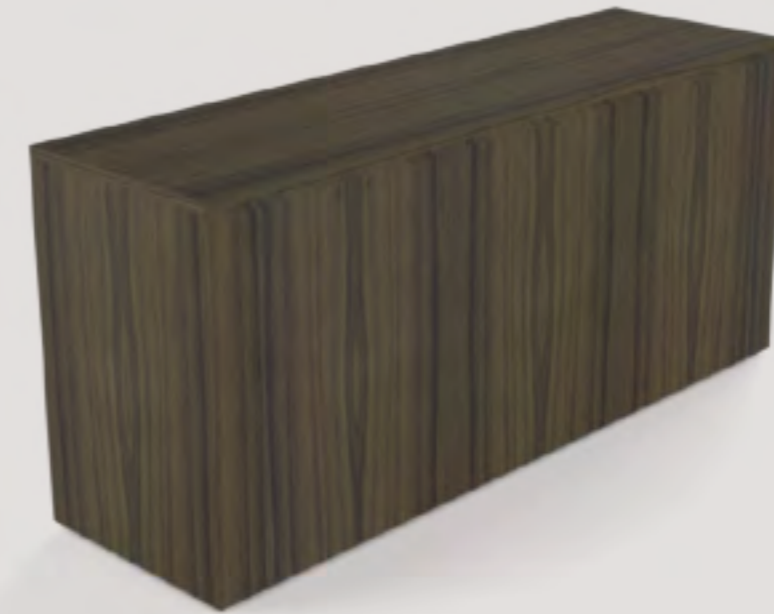

CUSTOMIZED SIDEBOARD WITH INBUILT SCREEN. MAX. SCREEN SIZE 65"
MUEBLE A MEDIDA CON TELEVISOR INCORPORADO. DIMENSIÓN MÁX. PANTALLA 65"



Premium bookcases Librerías 'Premium'

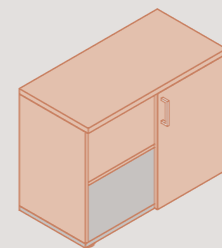

- Wood/Madera
- Laminated/Melamina

1800x450
h 700



2700x450
h 700



900x450
h 1340

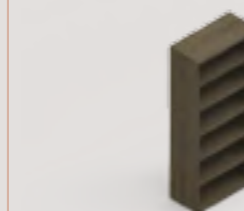

900x450
h 1980



2700x450
h 1340



1800x450
h 1980



2700x450
h 1980

Standard bookcases Librerías 'Standard'

Melamine options in black or white color
Opción de melamina en color negro o blanco

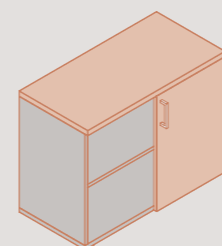

- Wood/Madera
- Laminated/Melamina

2700x450
h 700



2700x450
h 1980



1800x450
h 1980



900x450
h 1340



2700x450
h 700



2700x450
h 1980



1800x450
h 1980

Recommended with: Oxford and Titanium
Recomendaciones junto a: Oxford y Titanium



TECHNOLOGY

Power units



PU1
3/6 positions
Lacquer



PU4
2 positions
Matt chromed
Inox



PU2
3/6 positions
Wood



PU5
3/6 positions
RAL 9006 (aluminium)
RAL 7016 (anthracite)
Chromed
Inox
RAL 9005 (black)
RAL 9010 (white)



PU3
4/8 positions
RAL 9006 (aluminium)
RAL 9005 (black)



PU6
4/8 positions
RAL 9006 (aluminium)
RAL 9005 (black)



Power strips



HDMI
HDMI



RJ45 cat6
RJ45 cat6

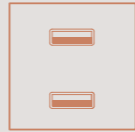

USB
USB



DVI

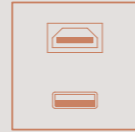

HDMI
USB



HDMI



XLR
3 pins



RCA



HDMI
RJ45 cat6



USB
RJ45 cat6



RJ45 cat6



Schuko



UK socket
45°

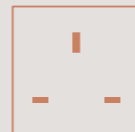

UK socket



USB



VGA
with jack

Options for power strip positions
Opciones para posiciones de la regleta

Cable outlets



CO1
Inox



CO2
Wood



CO3
RAL 9006 (aluminium)
RAL 9010 (white)
RAL 9005 (black)

Elevation



E1



Vertical canalization



VC1



VC2



VC3



VC4



Flap



F1



F2



F3



F4



F5

Vertical elevation



VE1



VE2



VE3



VE4



VE5

Accessories



A1

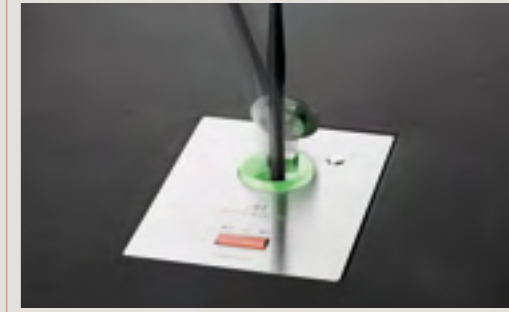

A2



A3



Screen sizes: 12" to 22"
Dimensiones pantallas: 12" a 22"

Finishes *Acabados*

BOS1964 only works with the absolute highest quality of finishes in wood as well as in upholstery with brands such as Kvadrat, Gabriel, Curtidos Gracia and Camira.

Next, you will find a selection of the available finishes which we work with. To know the whole collection, please visit the following site:

www.bos1964.com

BOS1964 utiliza en sus productos los mejores materiales en acabados de madera y en marcas de tapicería como Kvadrat, Gabriel, Curtidos Gracia y Camira.

A continuación, os presentamos una selección de nuestros acabados. Para conocer el catálogo entero visiten la siguiente dirección:

www.bos1964.com

Natural wood
Madera natural

The natural wood comes standard with matt finish but is also available with high gloss finish.

De serie, la madera natural tiene un acabado mate; pero también está disponible en alto brillo.

Lacquer & paint
Laca & pintura

These RAL colors are available for lacquer when applied on MDF and for paint when applied on metal parts. The lacquered colors are available with matt or piano lacquer finish (different RAL colors can be used upon request).

Los colores RAL, cuando son aplicados en madera son lacas y cuando son aplicados en superficies metálicas, son pinturas. Las lacas, están disponibles en mate o laca piano. Bajo petición, se puede aplicar cualquier color.

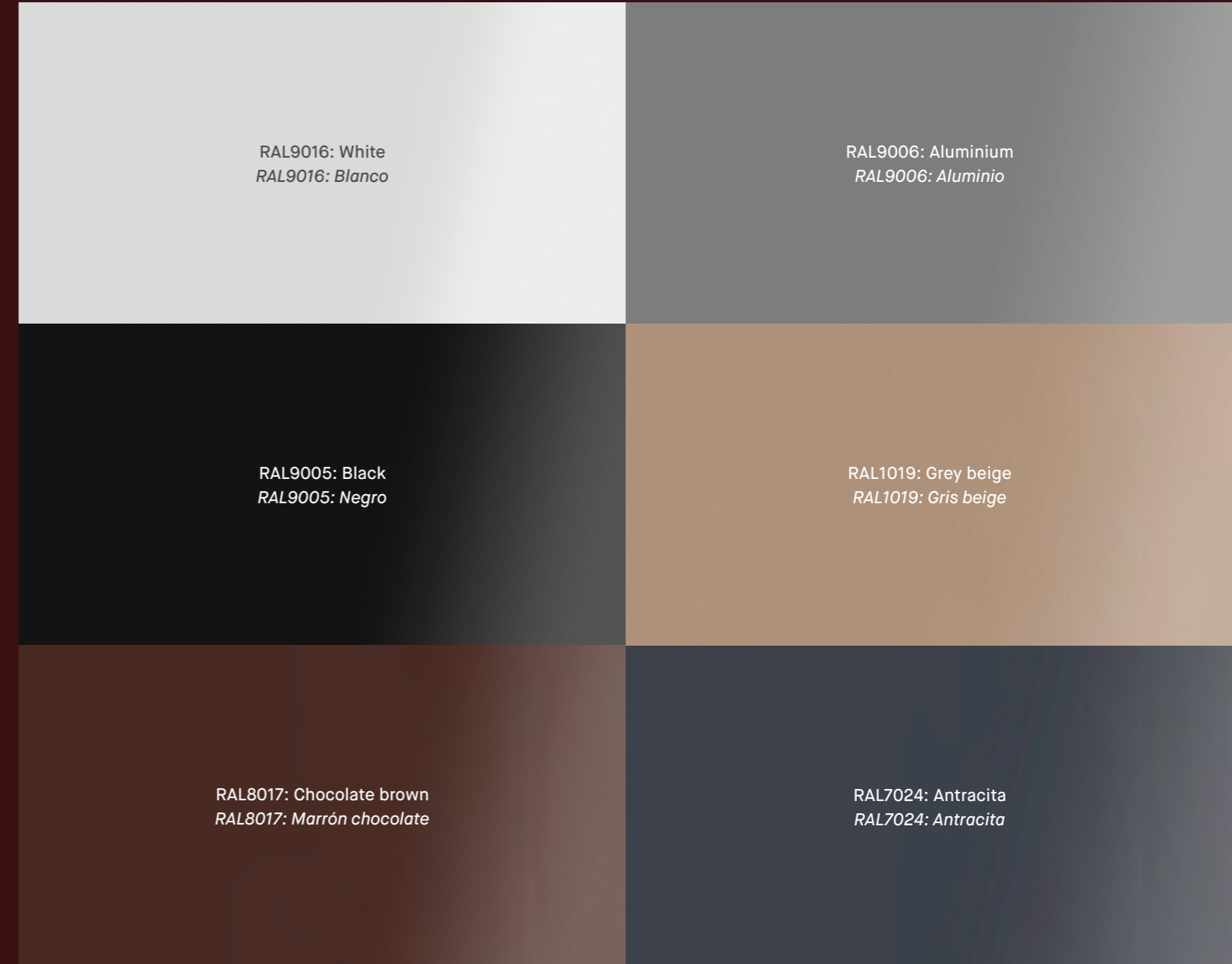
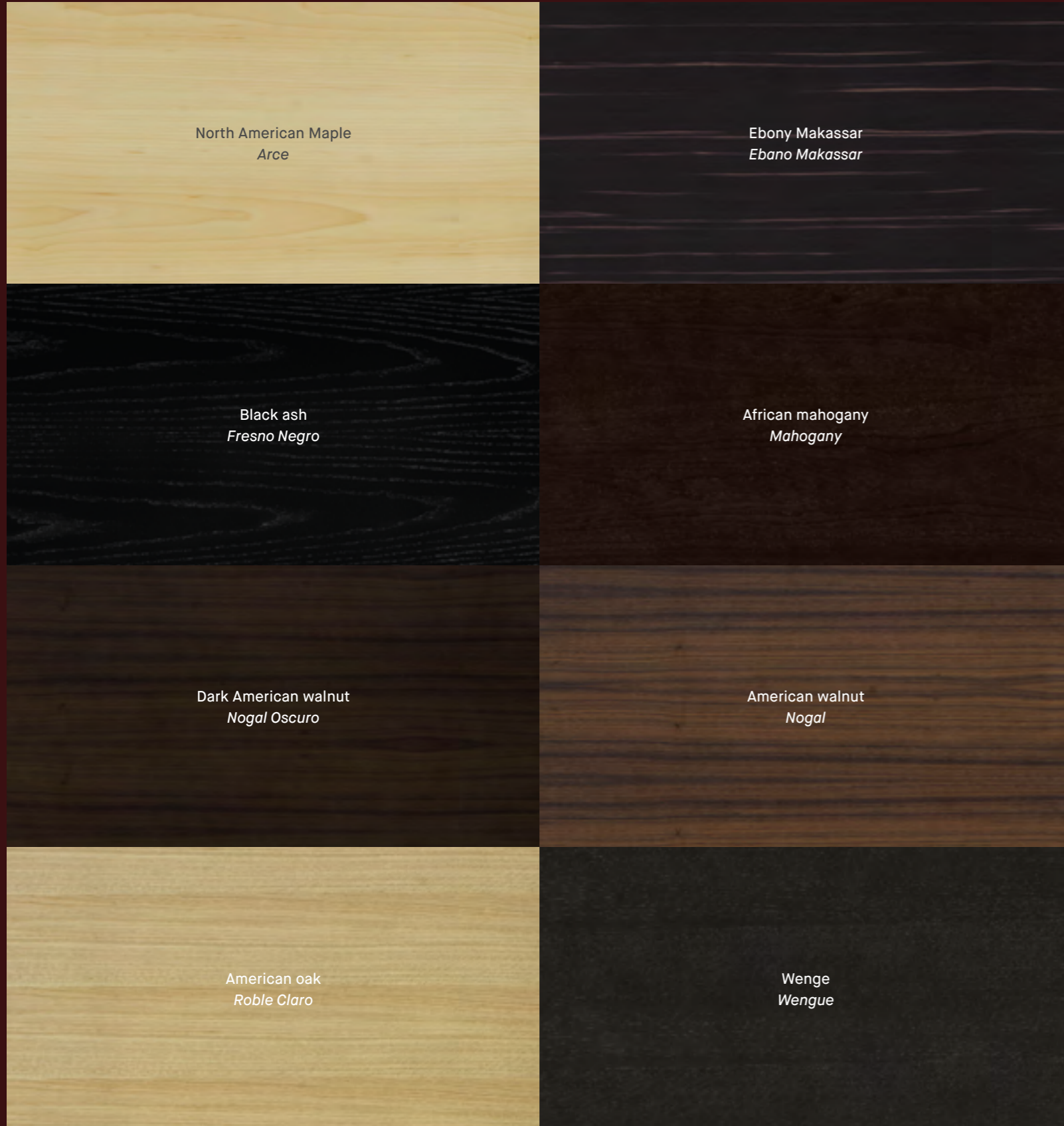

Serie 900 Fusion by Curtidos Gracia
Serie 900 Fusion de Curtidos Gracia



Blazer collection by Camira
Colección Blazer de Camira



Main Line Flax collection by Camira
Colección Main Line Flax de Camira



Thanks for trusting us

Gracias por confiar en nosotros

EUROPE

Barcelona airport
Allianz
Bank of london
Bayer
Danone
Fitch ratings
Gestamp
Good-year
Hospital de barcelona
Kone
Procter & gamble
Renault
Repsol
University de barcelona
Kempinski hotels
Mclaren mercedes benz
Henkel
Mitsubishi
Banco santander
Ing real estate
Heineken
Icbc
Rolex
France telecom
Porsche
Bnp
Bbl

CIS COUNTRIES

Compass
Kazchrome
Visor
Vtb bank
Marie claire
Sap
Boeing
Teva
Mondelez
Fti
Moscow mayor office
Apostol
Egvikinot
Total

MIDDLE EAST

Arab news channel
Gulf corporation for technology
K.O.C (kuwait oil company)
Nizwa bank
Mohsin haider darwish
The land
King saud university
Sama (saudi arabian monetary agency)
Sec (sceco)
Qassim university
Qatargas
Qatar foundation
Abu dhabi sports council
Crown prince court
Dubai airport
First gulf bank
Global investment group in fortune tower dubai
Magnificent media dubai
National bank of abu dhabi
Royal jet

AFRICA

African bank
Barclays
Carlyle
Cib bank
Limitless
Mantrac
Noor
Hsbc
Imperial investment
Municipality of cabinda
Intercontinental
Rama

BOS1964 provides innovative, client focused design furniture solutions for the world community of executive offices and boardrooms. One of our main objectives is to find a perfect balance between classic and modern designs that ensures durability as well as icons in terms of handcraft and innovation. This is achieved thanks to our dynamic multicultural team which, by combining top-notch technology and strong expertise in traditional manufacturing.

BOS1964 ofrece soluciones innovadoras y de diseño dirigidas a clientes de ámbito mundial interesados en mesas de despacho, mesas de reuniones y sillas de dirección. Estas soluciones vienen avaladas por una experiencia dilatada en los años que ha estudiado detenidamente la integración de estos productos en las distintas áreas de dirección adecuándose perfectamente a cualquier decoración y a cualquier ambiente.