

SETUP WALL LAMPS
MONTAJE LÁMPARAS APLIQUE

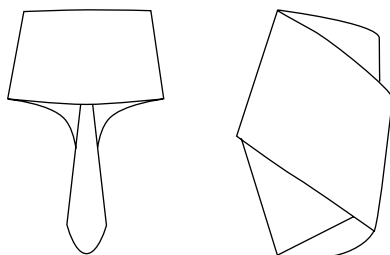

LZF

AIR, ORBIT

CONTENTS CONTENIDO

- 1 x Shade Pantalla
- 2x Screws & wall plugs Tornillos y tacos
- 1 x Allen Key Llave Allen

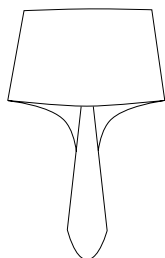

AIR A

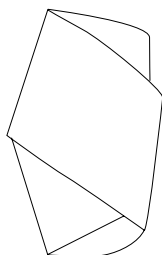

ORBIT A

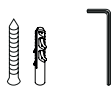

* Additional Contents UL (Only for Junction Box)

- 1 x Adjustable Back Plate
- 2 x Screws & Spherical nuts
- 1 x Allen key N° 2,5

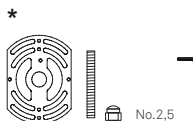

TECHNICAL SPECIFICATIONS ESPECIFICACIONES TÉCNICAS

Recommended bulb Bombilla recomendada

Class I Clase I 



AIR A

E14

LED Mini Globe DIM 1 x 5 W max.
LED regulable

220-240V 50-60Hz



ORBIT A

E27

LED Mini Globe DIM 1 x 11 W max.
LED regulable

220-240V 50-60Hz



AIR A

E12

LED Mini GLobe 1 x 5 W max

120-277V 50-60Hz



ORBIT A

E12

LED Mini GLobe 1 x 15 W max

120-277V 50-60Hz

1 OPEN ABRIR

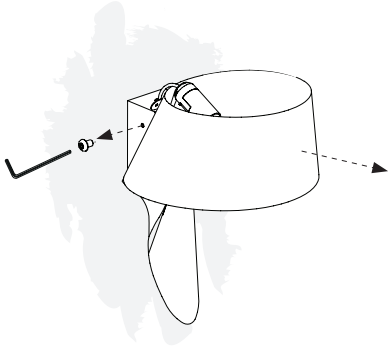

Use allen key N° 2,5
Usar llave allen N° 2,5

Remove these screws to separate the shade from the structure.

Quite los tornillos para separar la pantalla de la estructura.

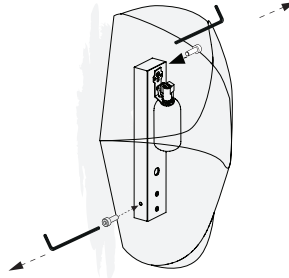

Use allen key N° 3
Usar llave allen N° 3

2 FIX TO THE WALL FIJAR AL LA PARED

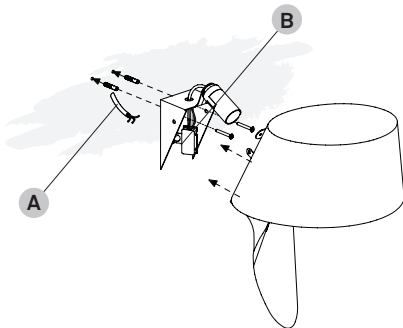

Wall mount. Feed the electrical wires (A) through the structure (B), screw the structure to the wall and connect the electrical wires to the main.

Montaje a pared. Pase los cables (A) a través de la estructura (B), atornille la estructura a la pared y conecte a la red eléctrica.

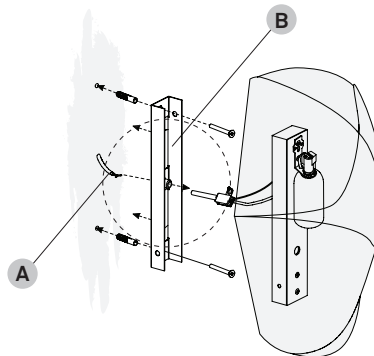

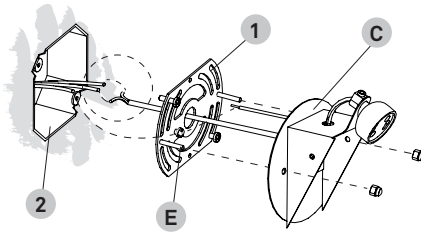

UL with Junction Box (USA and Canada)

Feed the electrical wires from the mains through the adjustable Jbox cover plate(1) then fix it to the junctionbox(2)

- Now feed the wires through the back plate (C) and the structure.
- Use the screws provided (E) to attach the fixture to the ajustable Jbox cover plate.
- Connect the electrical wires to the main

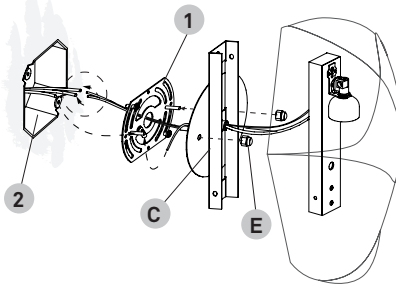

3 CONNECTION CONEXIÓN

You should have a three wire cable coming from the wall. Connect the Neutral (N), Ground (GND) and Line (F) to the corresponding holes in the orange terminal block.

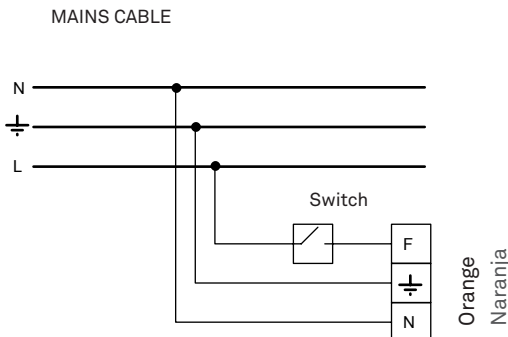

Debería tener una manguera de tres polos viniendo de la pared. Conecte el neutro (N), tierra (GND) y la línea (F) en la posición correspondiente a cada uno en la regleta de conexión naranja.

4 CLOSE CERRAR

Return the shade to its position. Put the holding screws back into place.

Colocar la pantalla en su posición una vez realizada la conexión y fijar los tornillos.

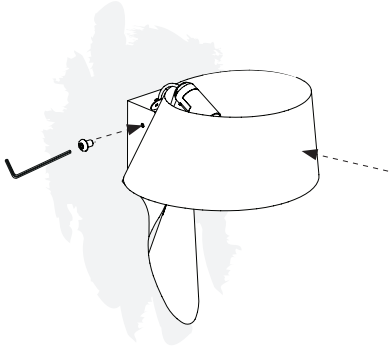

Use allen key N° 2,5
Usar llave allen N° 2,5

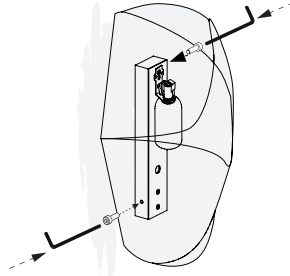

Use allen key N° 3
Usar llave allen N° 3

5 INSTALL THE BULB
INSTALAR BOMBILLA

Install the bulb.

Instalar la bombilla.

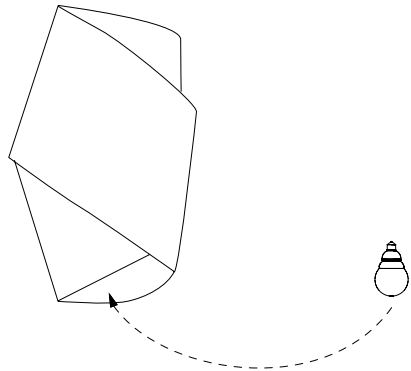
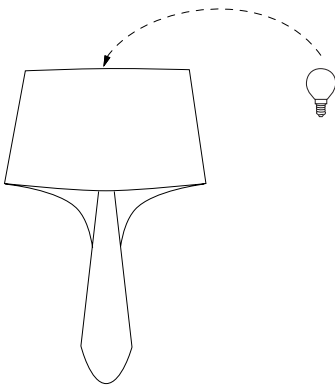

6

Turn on the mains again.
Conectar la tensión eléctrica.

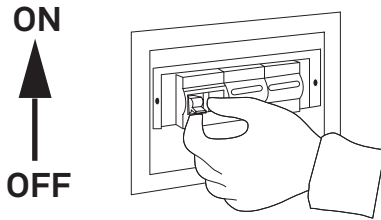

Use and care of your lamp.

You have just purchased an original handmade product by LZF. Your lamp is made out of FSC® certified natural wood veneer treated with our patented Timberlite® finish. This treatment both protects and safeguards the wood veneer against breakages.

CLEANING OF ...

The **shades** we recommended a feather duster or a damp cloth, clean only the flat surface of the veneer with the cloth, and please avoid any moisture contact along the edge of the veneer.

The **metallic surfaces** should be treated with care and cleaned with a soft damp cloth only. Make sure that moisture does not penetrate joints or junctions between metal parts. Do not use solvents of any kind.

The **acrylic diffusers** on your lamp can be cleaned with a regular window cleaning spray and a soft cloth. Do not use solvents of any kind.

PRECAUTIONS**Luminaire for indoor use only.**

Unplug the lamp before cleaning. Servicing or manipulation of the electrical installation should only be performed by qualified electrical personnel or by the LZF service department.

Glass

Improper handling can cause loosening or chipping of the glass. Any bubbles, or lack of homogeneity in the glass is a characteristic feature of hand blown glass and not a defect. The surface of the glass may also include imperfections due to its manual manufacturing. When cleaning, use a window cleaning spray and a soft cloth.

Avoid handling glass without gloves to prevent fingerprints and loss of gloss.

Wood veneer

Avoid direct sunlight, strong indirect sunlight and moisture on your lamp. Since wood is a natural material, a gradual change in tone may occur over time. Furthermore, if the lamps were purchased at different times, there will be differences in colour and tone, particularly in lighter coloured veneers. This is can not be considered a manufacturing defect or reason for complaint. Do not install your lamp near any air-conditioning vents or ventilation shafts as this may damage the wood veneer used in this fixture.

LEDS

If your lamps contains Integrated LED circuits do not touch the LED surface with your bare hands as this can reduce the life of your LED.

BULBS

Bulbs are normally not included, unless indicated. We recommend using energy-saving LED bulbs. Please refer to the instruction manual or visit our website www.lzf-lamps.com to make sure you are using the best bulb for your type of lamp.

KELVINS

Depending on the color of the wood veneer we recommend using different Kelvin light temperatures, for their optimum appearance: Blue 28, Turquoise 30 and Grey 29: 4000k
Ivory White 20, Natural Beech 22, and Natural Cherry 21: 3000 or 4000k.
Yellow 24, Orange 25, Red 26, Chocolate 31 & Pale Rose 33: 3000k.

Learn more about Kelvins.

Uso y cuidado de su lámpara

Acaba de adquirir un producto original y hecho a mano por LZF. Su lámpara está fabricada con chapa de madera natural certificada FSC® tratada con nuestro acabado patentado Timberlite®. Este tratamiento protege la madera, a la vez que evita posibles roturas.

LIMPIEZA DE ...

La madera, recomendamos usar un plumero o un paño húmedo, evitando incidir en los cantos de la chapa.

Las superficies metálicas deben tratarse con cuidado y limpiarse únicamente con un paño suave y húmedo. Asegúrese de que la humedad no penetre en las uniones de las partes metálicas. No use disolventes de ningún tipo.

Los difusores acrílicos se pueden limpiar con un líquido limpia cristales y un paño suave. No usar disolventes de ningún tipo.

PRECAUCIONES**Luminaria para uso exclusivo en interior.**

Desenchufar la lámpara antes de cambiar la bombilla o limpiarla. La manipulación de la instalación eléctrica debe efectuarse solo por personal cualificado o por LZF.

Vidrio

Un manejo inadecuado puede provocar que el vidrio se afloje o se astille. Cualquier burbuja, o falta de homogeneidad en el vidrio no es motivo de queja, este es un rasgo característico del vidrio soplado a mano.

La superficie del vidrio también puede presentar imperfecciones debido a su fabricación manual. Al limpiar, use un spray limpiacristales y un paño suave.

No manipule el vidrio sin guantes para evitar huellas dactilares y pérdida de brillo.

Madera

Evitar el sol directo o la luz intensa indirecta del sol y la humedad sobre la lámpara. Debido a que la madera es un material natural, pueden existir variaciones en el tono de ésta. Si las lámparas se adquieren en diferentes periodos de tiempo, pueden mostrar variaciones de color y tono sobre todo en las maderas de tonos claros. No situar la lámpara próxima a un salida de aire debido a que éste puede ocasionar daños en la misma. Luziferlamps S.L. no se hará responsable.

LEDS

Si su lámpara contiene LED integrado. No tocar nunca con las manos desnudas, ya que esto puede reducir la vida útil de su LED.

BOMBILLAS

Las bombillas no están incluidas, a menos que se indique. Recomendamos utilizar bombillas de bajo consumo LED. Consulte el manual de instrucciones o visite nuestro sitio web www.lzf-lamps.com para asegurarse de que está utilizando la mejor bombilla para su tipo de lámpara.

KELVINS

Dependiendo del color de la chapa de madera recomendamos utilizar diferentes temperaturas de luz, para su óptimo aspecto: Azul 28, Turquesa 30 y Gris 29: 4000k.
Ivory White 20, Natural Beech 22 y Natural Cherry 21: 3000 o 4000k.
Amarillo 24, Naranja 25, Rojo 26, Chocolate 31 y Rosa Palo 33: 3000k.

Saber más sobre Kelvins.

MÁS INFORMACIÓN: <http://www.lzf-lamps.com/guarantee/>



MORE INFO: <http://www.lzf-lamps.com/guarantee/>

© Luziferlamps, S.L. All rights reserved. Valencia, Spain. 2020 - www.lzf-lamps.com - support@lzf-lamps.com