

**viccarbe**

# Burin

---

Designed by Patricia Urquiola

Technical info - Outdoor

HEIGHT 74 | 29<sup>3</sup>/<sub>4</sub>"

**BUD60CNEX**  
table round 60 | 23<sup>5</sup>/<sub>8</sub>"

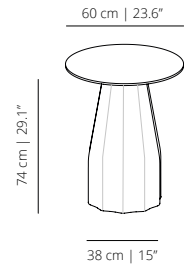

HEIGHT 74 | 29<sup>3</sup>/<sub>4</sub>"

**BUD80CNEX**  
table round 80 | 31<sup>1</sup>/<sub>2</sub>"

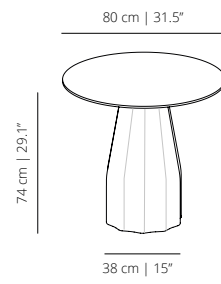

HEIGHT 74 | 29<sup>3</sup>/<sub>4</sub>"

**BUD120CNEX**  
table round 120 | 47<sup>1</sup>/<sub>4</sub>"

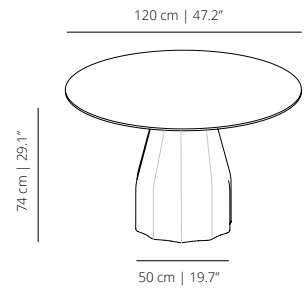

**BUD70CNEX**  
table round 70 | 27<sup>6</sup>/<sub>16</sub>"

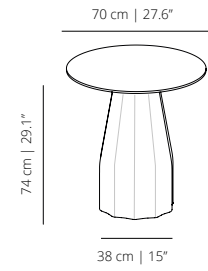

**BUD100CNEX**  
table round 100 | 39<sup>3</sup>/<sub>8</sub>"

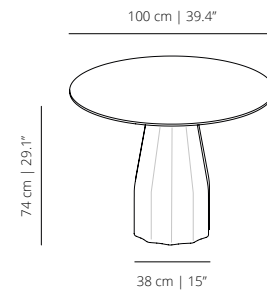

**BUC70CNEX**  
table 70x70 | 27<sup>6</sup>/<sub>16</sub>" x 27<sup>6</sup>/<sub>16</sub>"

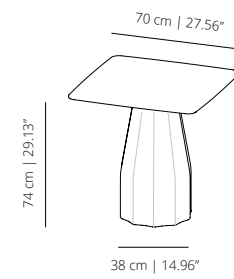

HEIGHT 74 | 29<sup>3</sup>/<sub>4</sub>"

**BUC80CNEX**  
table 80x80 | 31<sup>1</sup>/<sub>2</sub>" x 31<sup>1</sup>/<sub>2</sub>"

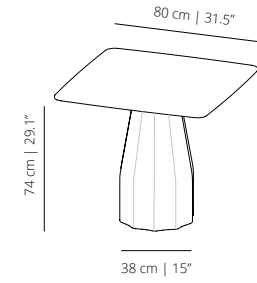

HEIGHT 74 | 29<sup>3</sup>/<sub>4</sub>"

**BUC100CNEX**  
table 100x100 | 39.37" x 39.37"

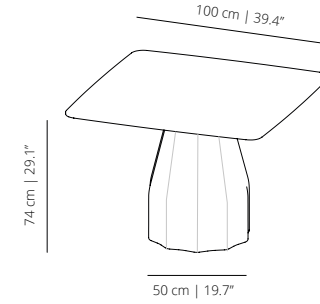

**BUC90CNEX**  
table 90x90 | 35<sup>7</sup>/<sub>16</sub>" x 35<sup>7</sup>/<sub>16</sub>"

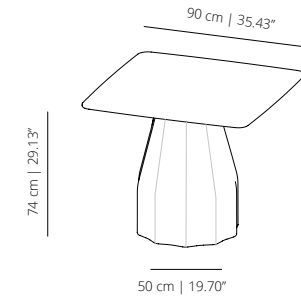

HEIGHT 102 | 40<sup>3</sup>/<sub>16</sub>

**BUD60HCNEX**  
table round 60 | 23<sup>5</sup>/<sub>8</sub>

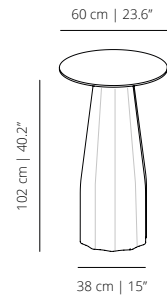

**BUD70HCNEX**  
table round 70 | 27<sup>6</sup>/<sub>16</sub>

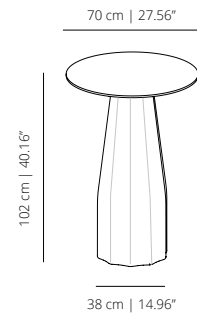

HEIGHT 102 | 40<sup>3</sup>/<sub>16</sub>

**BUD80HCNEX**  
table round 80 | 31<sup>1</sup>/<sub>2</sub>

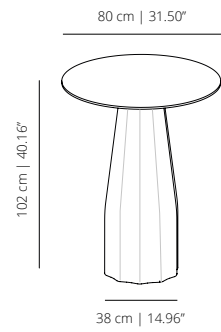

**BUD100H**  
table round 100 | 39<sup>3</sup>/<sub>8</sub>

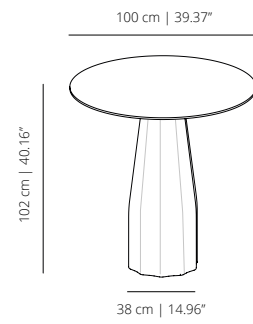

HEIGHT 102 | 40<sup>3</sup>/<sub>16</sub>

**BUC70HCNEX**  
table 70x70 | 27<sup>6</sup>/<sub>16</sub> x 27<sup>6</sup>/<sub>16</sub>

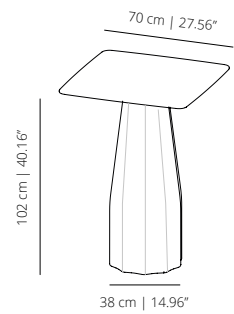

**BUC80HCNEX**  
table 80x80 | 31<sup>1</sup>/<sub>2</sub> x 31<sup>1</sup>/<sub>2</sub>

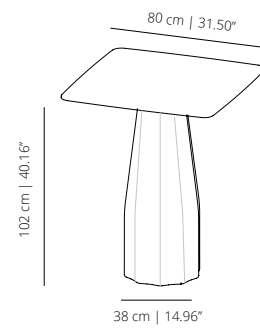

Heights and types of bases available:

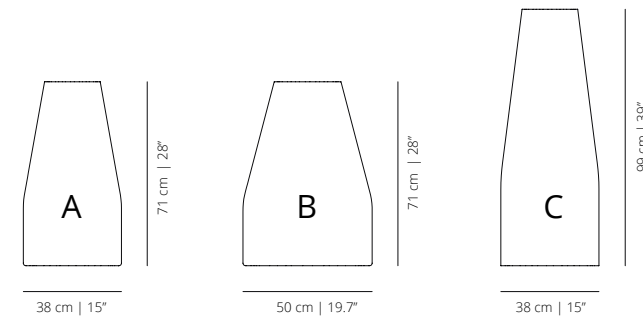

Range of tops for base A: D60 - D100 | 60x60

D23.6" - D39.4" | 23.6"x23.6"

Range of tops for base B: D120 - D150 | 90x90 - 100x100

D47.2" | 35.4"x 35.4" - 39.4"x39.4"

Range of tops for base C: D60 - D100 | 70x70 - 80x80

D23.6" - D39.4" | 27.6"x27.6" - 31.5"x 31.5"

## FINISHES

### TABLETOPS MATERIALS

#### Compact

12 mm thick compact laminated table top. The edge can be in black or white. With a black edge, the surface of the tabletop can be black or white; for a white edge, it can be white.



12 mm



black

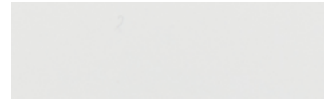

white

### BASE OPTIONS

Central support available in roto-moulded polyethylene in white, black or taupe.



white  
RAL 9003



black  
RAL 9005



taupe  
RAL 1019

*NOTE: Outdoor cover available to protect the product from water, humidity and sunlight.*

### SEATING CAPACITY

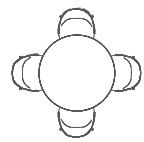

**Up to 4**

D60 - D100 cm | D23.6" - D39.4"

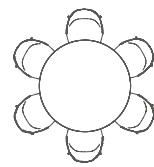

**Up to 6**

D120 cm | D47.2"

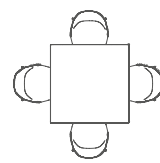

**Up to 4**

70x70 - 100x100 cm | 27.6x27.6" - 39.4x39.4"

*\*Seats calculated using Maarten chair, might differ when choosing other models*

## ACCESSORIES & ELECTRIFICATIONS



**USB hub with battery.** USB hub with two USB device charging ports without being plugged into electric current. It's needed to buy the battery charging tray to charge the USB hub battery.



**Battery charging tray.** Charges up to four stations simultaneously in 7 hours. Includes magnetic key to remove the station from its support

*NOTE: Outdoor cover available to protect the product from water, humidity and sunlight.*

### CERTIFICATIONS

*Follows the outdoor regulation: UNE EN 581-2:2016.*

# Let's talk

We want to help you find the best designs for your project. Contact us and our team will get back to you as soon as possible.

[CONTACT US](#)