

# B.lux

What's New V4

Decorative  
Lighting

Architectural  
Lighting

Outdoor  
Lighting

**[bluxlighting.com](http://bluxlighting.com)**







B.lux

Decorative  
lighting





**B.lux**

# Beaded S

by  
Werner Aisslinger

Decorative  
lighting

Decorative  
lamps

Beaded S is a family of pendant luminaires manufactured in aluminium and blown glass. Beaded is available in an individual version (S1) or in clusters of 3 or 5 light fittings (S3 and S5), as well as in a horizontal version with two or three luminaires (SH2 and SH3). Its double blown glass diffuser is available in opal white or smoke grey; the latter option contains a flat internal diffuser to prevent the light source from being seen. These luminaires can be freely installed at different heights, meaning they can be adapted to any height. The central aluminium ring is made with a textured matte black finish.

Beaded S es una familia de luminarias de suspensión fabricada en aluminio y vidrio soplado. Beaded está disponible en versión individual vertical (S1) o en clústeres verticales de 3 o 5 luminarias (S3 y S5), así como en versión horizontal de dos o tres luminarias (SH2 y SH3). Su doble difusor de vidrio soplado está disponible en blanco opal o gris fumé; esta última opción contiene un difusor interno plano para evitar ver la fuente de luz. Las luminarias se pueden instalar a diferentes alturas de forma libre, permitiendo adecuarlas a cualquier altura. El anillo central de aluminio se fabrica en acabado negro mate texturizado.

Beaded S ist eine Familie von Pendelleuchten aus Aluminium und geblasenem Glas. Beaded ist als individuelle Version (S1), als Verbund von 3 oder 5 Leuchten (S3 und S5) sowie als horizontale Version mit zwei oder drei Leuchten (SH2 und SH3) erhältlich. Ihr doppelter Diffusor aus geblasenem Glas ist in Opalweiß oder Rauchgrau erhältlich, wobei die zweite Option einen flachen internen Diffusor enthält, sodass die Lichtquelle nicht sichtbar ist. Die Leuchten können in verschiedenen Höhen frei installiert werden und erlauben somit die Anpassung an jede Höhe. Der zentrale Aluminiumring hat eine strukturierte mattschwarze Oberfläche.





# Beaded



## BEADED S1

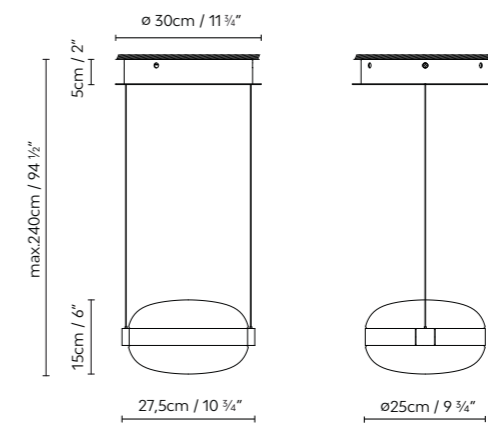

● Smoke Grey ○ Opal

772310  
772311

**BEADED S1 SMOKE GREY**  
**BEADED S1 OPAL**

LED 2 x 11W 2500lm 2700K CRI≥90 230V DIM PUSH/DALI

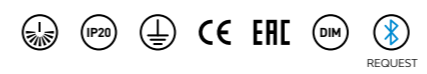

\* Custom S2 under request.



## BEADED S3

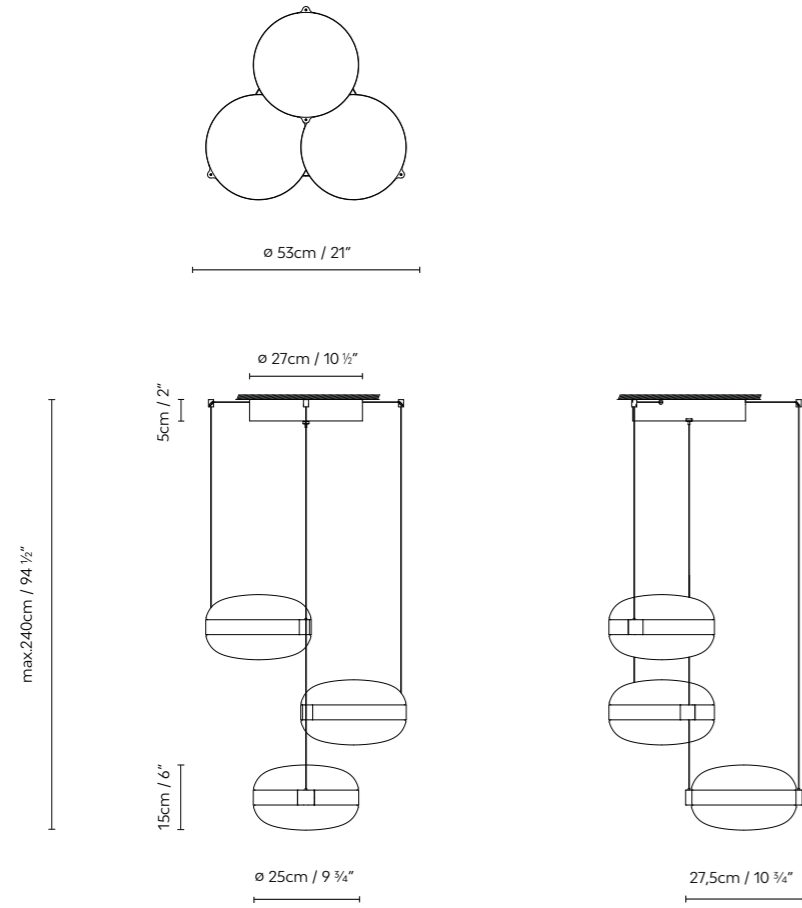

● Smoke Grey ○ Opal

772330 **BEADED S3** SMOKE GREY LED 6 x 11W 7500lm 2700K CRI≥90 230V DIM PUSH/DALI  
772331 **BEADED S3** OPAL



## BEADED S5

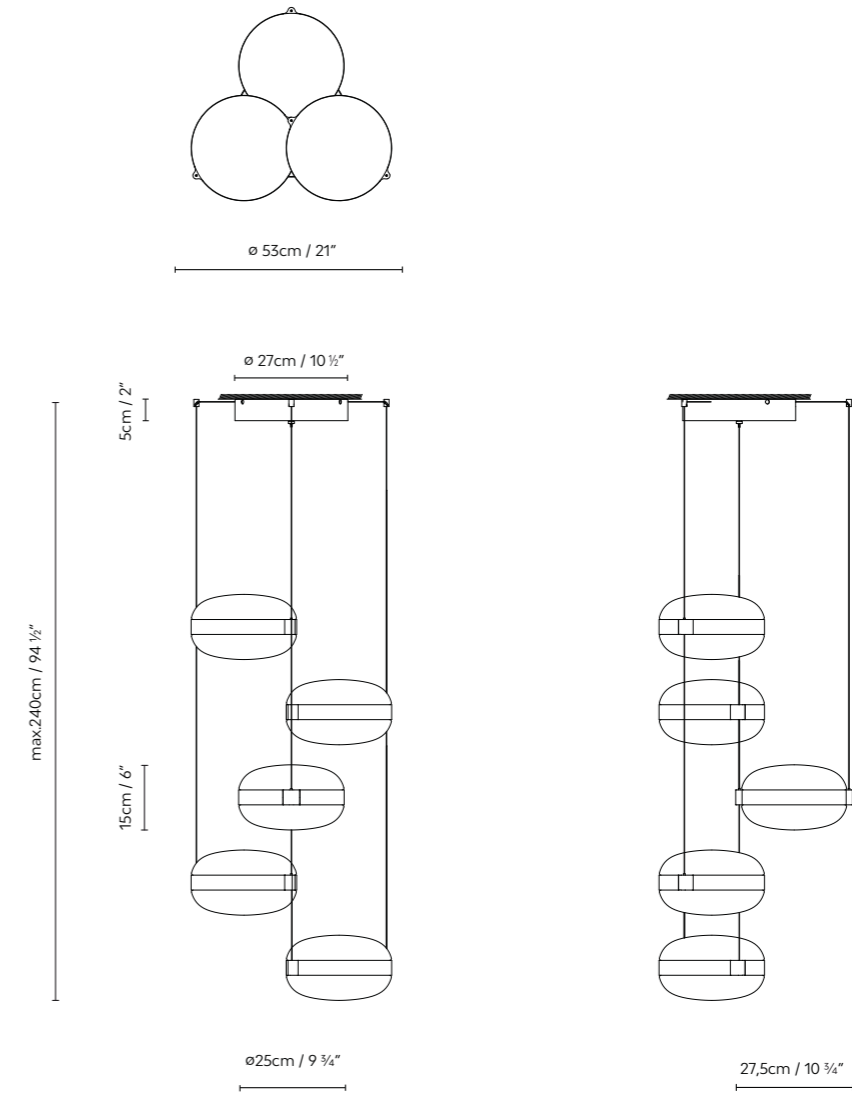

● Smoke Grey ○ Opal

772350 **BEADED S5** SMOKE GREY LED 10 x 11W 12500lm 2700K CRI≥90 230V DIM PUSH/DALI  
772351 **BEADED S5** OPAL

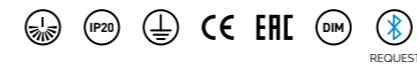





BEADED SH2

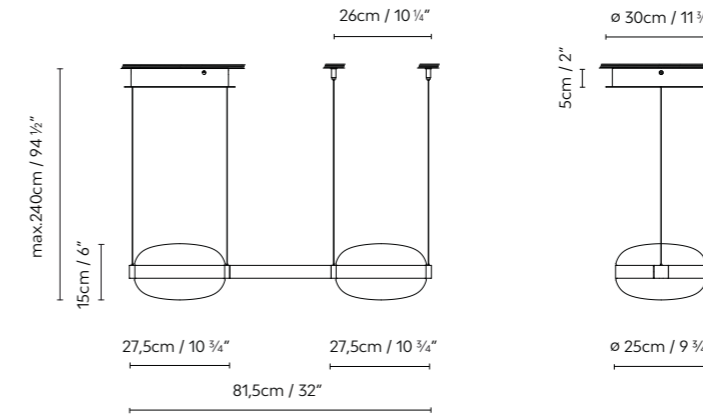

BEADED SH3

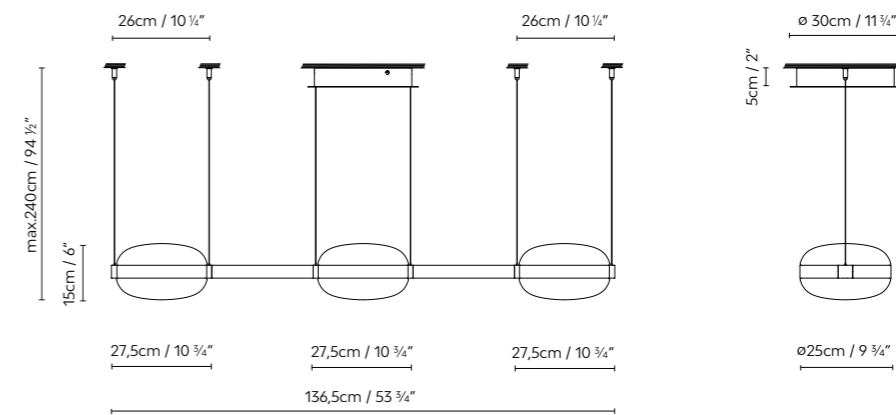

- Smoke Grey
- Opal

772370	<b>BEADED SH2 SMOKE GREY</b>	LED 4 x 11W 5000lm 2700K CRI≥90 230V DIM PUSH/DALI
772371	<b>BEADED SH2 OPAL</b>	
772380	<b>BEADED SH3 SMOKE GREY</b>	LED 6 x 11W 7500lm 2700K CRI≥90 230V DIM PUSH/DALI
772381	<b>BEADED SH3 OPAL</b>	

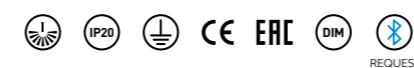



**B.lux**

# Beaded F

by  
Werner Aisslinger

Decorative  
lighting

Floor  
lamps

Beaded F is a floor lamp manufactured in aluminium and blown glass. Its double diffuser, for direct and indirect light, is available in opal white or smoke grey; the latter option contains a flat internal diffuser to prevent the light source from being seen. The central aluminium ring is made with a textured matte black finish.

Beaded F es una luminaria de pie fabricada en aluminio y vidrio soplado. Su doble difusor de luz directa e indirecta está disponible en blanco opal o gris fumé; esta última opción contiene un difusor interno plano para evitar ver la fuente de luz. El anillo central de aluminio se fabrica en acabado negro mate texturizado.

Beaded F ist eine Stehleuchte aus Aluminium und geblasenem Glas. Ihr doppelter Diffusor mit direktem und indirektem Licht ist in Opalweiß oder Rauchgrau erhältlich, wobei die zweite Option einen flachen internen Diffusor enthält, sodass die Lichtquelle nicht sichtbar ist. Der zentrale Aluminiumring hat eine strukturierte mattschwarze Oberfläche.

BEADED F

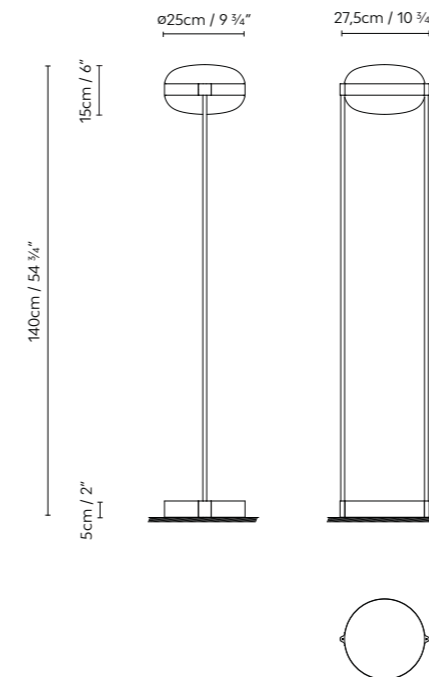

● Smoke Grey ○ Opal

772200  
772201

**BEADED F SMOKE GREY**  
**BEADED F OPAL**

LED 2 x 11W 2500lm 2700K CRI≥90 230V DIM





B.lux

# Beaded T

by  
Werner Aisslinger

Decorative  
lighting

Table  
lamps

Beaded T is a table lamp made of aluminium and blown glass. Its double diffuser, for direct and indirect light, is available in opal white or smoke grey; the latter option contains a flat internal diffuser to prevent the light source from being seen. The central aluminium ring is made with a textured matte black finish.

Beaded T es una luminaria de mesa fabricada en aluminio y vidrio soplado. Su doble difusor, de luz directa e indirecta, está disponible en blanco opal o gris fumé; esta última opción contiene un difusor interno plano para evitar ver la fuente de luz. El anillo central de aluminio se fabrica en acabado negro mate texturizado.

Beaded T ist eine Tischleuchte aus Aluminium und geblasenem Glas. Ihr doppelter Diffusor mit direktem und indirektem Licht ist in Opalweiß oder Rauchgrau erhältlich, wobei die zweite Option einen flachen internen Diffusor enthält, sodass die Lichtquelle nicht sichtbar ist. Der zentrale Aluminiumring hat eine strukturierte mattschwarze Oberfläche.



## BEADED T

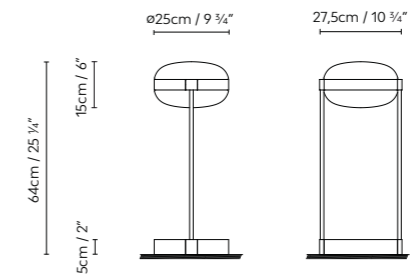

● Smoke Grey    ○ Opal

772000  
772001

**BEADED T SMOKE GREY**  
**BEADED T OPAL**

LED 2 x 11W 2500lm 2700K CRI≥90 230V DIM





**B.lux**

# Beaded C

by  
**Werner Aisslinger**

**Decorative  
lighting**

**Ceiling  
lamps**

Beaded C is a ceiling light with small dimensions and made of aluminium and blown glass. Its diffuser is available in opal white or smoke grey; the latter option contains a flat internal diffuser to prevent the light source from being seen. The central aluminium ring is made with a textured matte black finish.

Beaded C es un plafón de dimensiones contenidas fabricado en aluminio y vidrio soplado. Su difusor está disponible en blanco opal o gris fumé; esta última opción contiene un difusor interno plano para evitar ver la fuente de luz. El anillo central de aluminio se fabrica en acabado negro mate texturizado.

Beaded C ist eine Deckenleuchte mit kompakten Abmessungen aus Aluminium und geblasenem Glas. Ihr Diffusor ist in Opalweiß oder Rauchgrau erhältlich, wobei die zweite Option einen flachen internen Diffusor enthält, sodass die Lichtquelle nicht sichtbar ist. Der zentrale Aluminiumring hat eine strukturierte mattschwarze Oberfläche.



## BEADED C

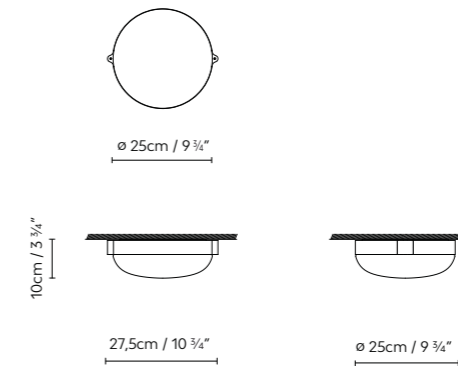

● Smoke Grey    ○ Opal

772400  
772401

**BEADED C SMOKE GREY**  
**BEADED C OPAL**

LED 11W 1250lm 2700K CRI $\geq$ 90 230V





**B.lux**

# Berry S

by  
Stones Designs

Decorative  
lighting

Ceiling  
lamps

Berry S is an individual pendant light fitting with a light head equipped with a magnetic system that allows it to be moved with complete freedom. Berry has a lens with a 36° aperture, which provides highly controlled lighting that can be freely focused wherever required. Finishes: Black, white, beige or bronze.

Berry S es una luminaria de suspensión individual con una cabeza lumínica dotada de un sistema magnético que nos permite moverla con total libertad. Berry cuenta con una lente de 36° de apertura que proporciona una luz muy controlada para focalizarla libremente allá donde se desee. Acabados: Negro, blanco, beige o bronce.

Berry S ist eine individuelle Pendelleuchte mit einem Leuchtenkopf, dessen Magnetsystem es ermöglicht, ihn frei zu bewegen. Berry hat eine Linse mit 36°-Öffnungswinkel für ein sehr kontrolliertes Licht, das Sie beliebig auf die gewünschte Stelle fokussieren können. Ausführungen: Schwarz, Weiß, Beige oder Bronze.







**BERRY S**

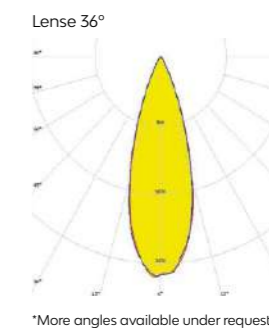
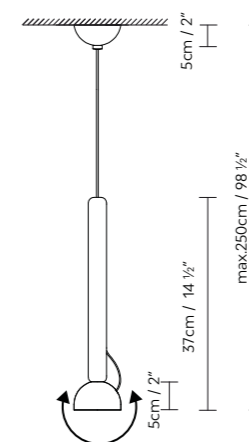
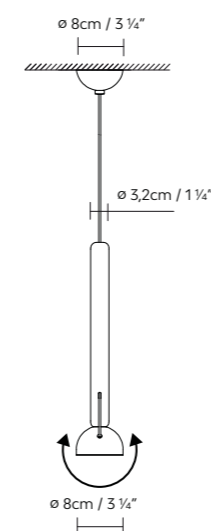

- Black (matte)
- White (matte)
- Beige (matte)
- Bronze (matte)

- 766300 **BERRY S BLACK**
- 766301 **BERRY S WHITE**
- 766302 **BERRY S BEIGE**
- 766303 **BERRY S BRONZE**

LED 4,5W 546lm 250mA 2700K CRI≥90 230V





**B.lux**

# Berry F

by  
**Stone Designs**

**Decorative  
lighting**

Ceiling  
lamps

Berry F is a floor lamp with a lighting head that's equipped with a magnetic system enabling it to be moved with complete freedom. Berry has a lens with a 36° aperture, which provides highly controlled lighting that can be freely focused wherever required. In addition, its head can rotate 360°, meaning it can be used for either direct or indirect lighting. Finishes: Black, white, beige or bronze.

Berry F es una luminaria de pie con una cabeza lumínica dotada de un sistema magnético que nos permite moverla con total libertad. Berry cuenta con una lente de 36° de apertura que proporciona una luz muy controlada para focalizarla libremente allá donde se desee. Además, la cabeza gira 360°, permitiendo emplearla como luz directa o indirecta. Acabados: Negro, blanco, beige o bronce.

Berry F Stehleuchte mit einem Leuchtenkopf, dessen Magnetsystem es ermöglicht, ihn frei zu bewegen. Berry hat eine Linse mit 36°-Öffnungswinkel für ein sehr kontrolliertes Licht, das Sie beliebig auf die gewünschte Stelle fokussieren können. Außerdem ist der Kopf um 360° drehbar, sodass er für direktes oder indirektes Licht verwendet werden kann. Ausführungen: Schwarz, Weiß, Beige oder Bronze.

## BERRY F

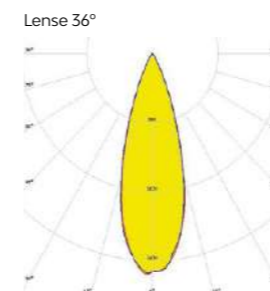
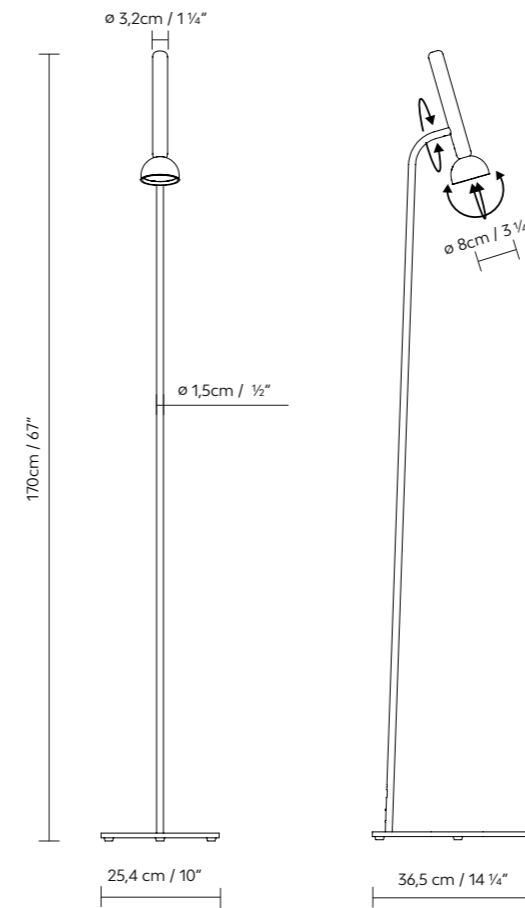

\*More angles available under request



● Black (matte) ○ White (matte) ● Beige (matte) ● Bronze (matte)

766200 **BERRY F BLACK**  
766201 **BERRY F WHITE**  
766202 **BERRY F BEIGE**  
766203 **BERRY F BRONZE**

LED 4,5W 546lm 250mA 2700K CRI≥90 230V





**B.lux**

# Berry W

by  
Stone Designs

Decorative  
lighting

Wall  
lamps



Berry W is an individual wall light with a lighting head that's equipped with a magnetic system enabling it to be moved with complete freedom. Berry has a lens with a 36° aperture, which means the light can be easily controlled to freely focus it wherever required, allowing it to be used as ambient lighting or a reading light. Finishes: Black, white, beige or bronze.

Berry W es una luminaria de aplique individual con una cabeza lumínica dotada de un sistema magnético que nos permite moverla con total libertad. Berry cuenta con una lente de 36° de apertura que proporciona una luz muy controlada para focalizarla libremente allí donde se desee, permitiendo emplearla como luz de ambiente o de lectura. Acabados: Negro, blanco, beige o bronce.

Berry W eine individuelle Wandleuchte mit einem Leuchtenkopf, dessen Magnetsystem es ermöglicht, ihn frei zu bewegen. Berry hat eine Linse mit 36°-Öffnungswinkel für ein sehr kontrolliertes Licht, das Sie beliebig auf die gewünschte Stelle fokussieren können, sodass die Verwendung als Umgebungs- oder Leselicht möglich ist. Ausführungen: Schwarz, Weiß, Beige oder Bronze.

## BERRY W

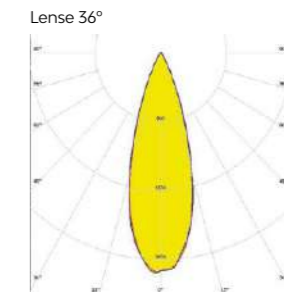
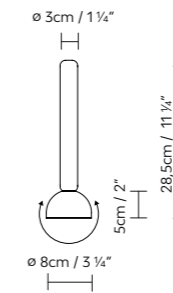
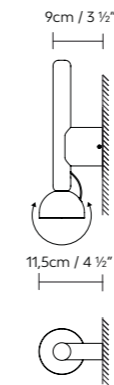

\*More angles available under request

● Black (matte) ○ White (matte) ● Beige (matte) ● Bronze (matte)

766110 **BERRY W BLACK**  
766111 **BERRY W WHITE**  
766112 **BERRY W BEIGE**  
766113 **BERRY W BRONZE**

LED 4,5W 546lm 250mA 2700K CRI≥90 230V





**B.lux**

# Bowee W3

by  
**Werner Aisslinger**

**Decorative  
lighting**

Wall  
lamps

LED wall lamp made with a half-sphere shades. The light source can be adjusted on its horizontal axis and gives direct and diffused light. Available in matte black, matte turquoise and matte beige.

Luminaria LED de pared formada por una pantalla de forma semiesférica. La fuente de luz es orientable en su eje horizontal, y emite luz directa y difusa. Disponible en acabado negro mate, turquesa mate, y beige mate.

LED-Wandleuchte bestehend aus halbkugelförmigen Schirmen. Die Lichtquelle ist auf ihrer horizontalen Achse ausrichtbar und gibt direktes sowie diffuses Licht ab. Verfügbar in einer matt Schwarzbenen, matt türkisfarbenen und matt beigefarbenen Ausführung.



## BOWEE W3

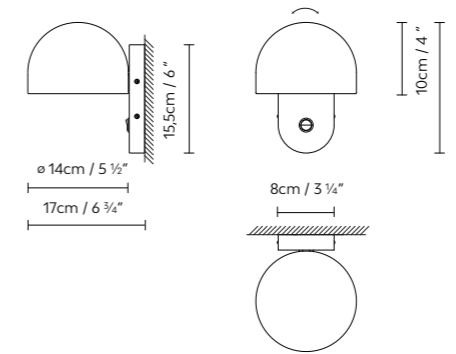

● Beige (matte) ● Clear turquoise (matte) ● Black (matte)

758130 **BOWEE W3** BEIGE  
758131 **BOWEE W3** CLEAR TURQUOISE  
758133 **BOWEE W3** BLACK

LED 8W 560lm 2700K CRI≥90 230V





**B.lux**

# C\_Ball Number

by  
**Stone Designs**

**Decorative  
lighting**

Wall  
lamps

Decorative wall lamp consisting of an opal glass sphere and metal components finished in satin brass or matte black. The C\_Ball Number option allows us to add numbers to the luminaire. This solution is focused on the hospitality market.

Aplique decorativo formado por una esfera de vidrio opal y partes metálicas acabadas en latón satinado, o en negro mate. También está disponible la opción C\_Ball Number, orientada al sector hotelero, que permite personalizar la luminaria con números.

Dekorative Wandleuchte mit einer Opalgaskugel und Metallteilen in den Ausführungen Blech satiniert oder Schwarz lackiert. Auch erhältlich in der Variante Option C\_Ball Number für den Hotelsektor, welche die Personalisierung der Leuchte mit Nummern ermöglicht.



## C\_BALL W NUMBER

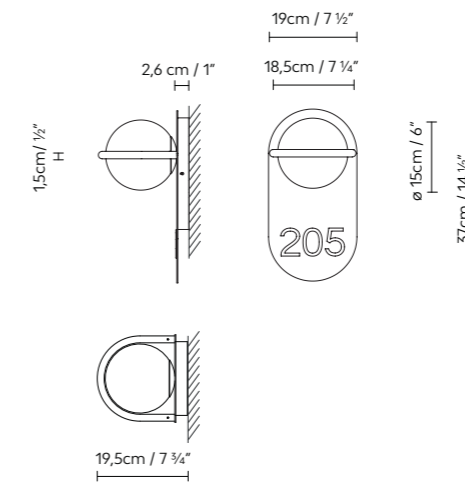

● Brass (satin) ● Black (matte)

748400 **C\_BALL W NUMBER BRASS** LED 6W (E14)

\*Custom colours and braille option available under request.





**B.lux**

# Crosshatch S

by  
**Brad Ascalon**

**Decorative  
lighting**

lamps

Crosshatch S is a pendant light comprised of a metal grid structure available in two formats (M and L) and a light source made of blown glass. Its internal wiring means both sizes can be combined with each other to create multiple compositions that use a single connection. The lightness of its structure enables the creation of large volumes without overloading the space.

Crosshatch S es una suspensión formada por una estructura reticular metálica disponible en dos formatos (M y L) y fuente de luz fabricada en vidrio soplado. Su cableado interno permite combinar ambos tamaños entre sí para crear múltiples composiciones empleando una única toma eléctrica. La ligereza de su estructura permite crear grandes volúmenes sin recargar el espacio.

Crosshatch S ist eine Aufhängung, die aus einer Metallgitterstruktur besteht und in zwei Größen (M und L) und Lichtquelle aus geblasenem Glas. Die interne Verkabelung erlaubt die Kombination beider Größen, sodass verschiedene Kompositionen an einer einzigen Steckdose kreiert werden können. Die Leichtigkeit der Struktur ermöglicht die Erschaffung großvolumiger Elemente, ohne den Raum zu überladen.





# Crosshatch



Decorative lighting

Suspension lamps

CROSSHATCH S-M

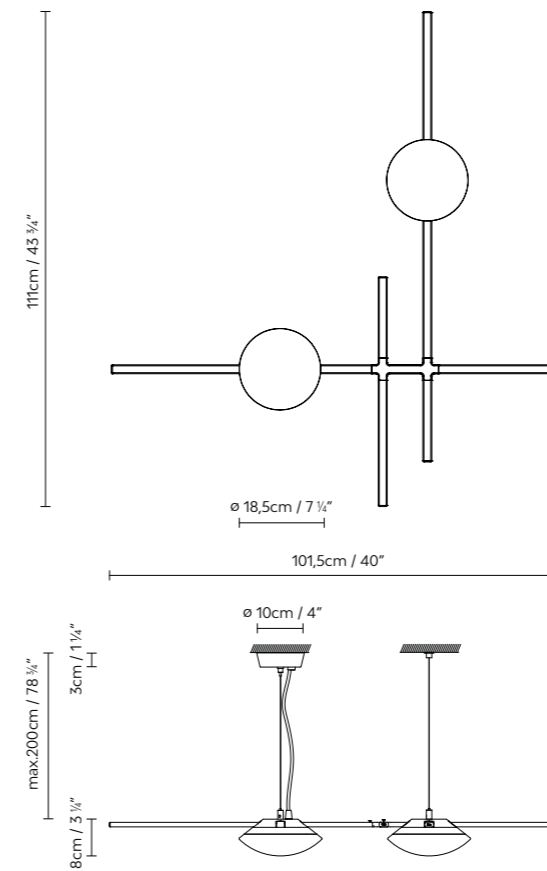

CROSSHATCH S-L

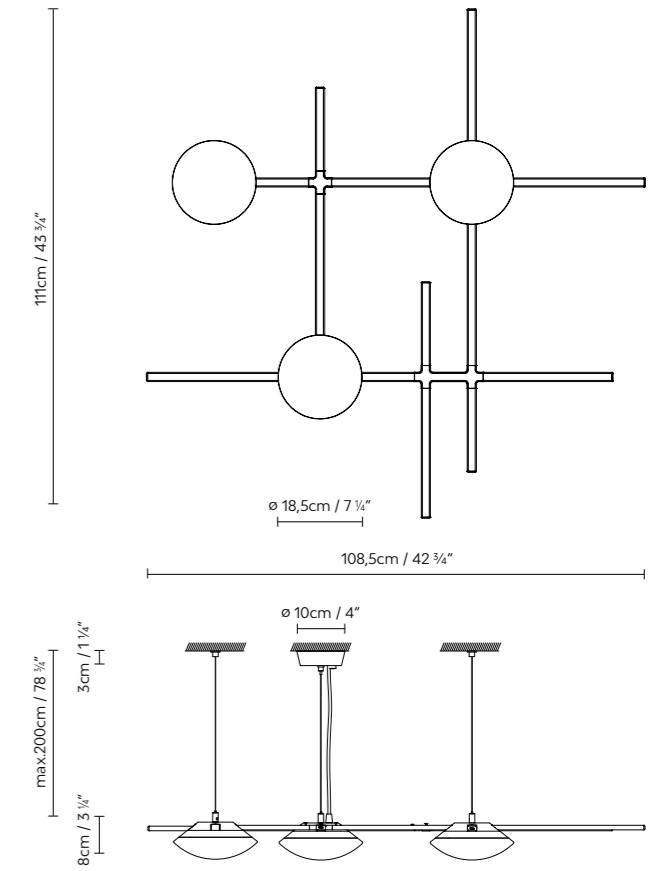

● Black (matte)

767310  
767320

**CROSSHATCH S - M**  
**CROSSHATCH S - L**

2x LED 16W 2810lm 2700K CRI≥90 230V DIM PHASE CUT  
3x LED 16W 4215lm 2700K CRI≥90 230V DIM PHASE CUT

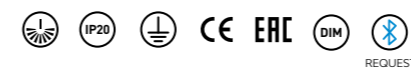



**B.lux**

# Crosshatch C

by  
**Brad Ascalon**

**Decorative  
lighting**

lamps

Crosshatch C is a ceiling light comprised of a metal grid structure available in three formats (S, M and L) and a light source made of blown glass. Its internal wiring means the three sizes can be combined with one another to create multiple compositions using a single connection. The lightness of its structure enables the creation of large volumes without overloading the space.

Crosshatch C es un plafón formado por una estructura reticular metálica disponible en tres formatos (S, M y L) y fuente de luz fabricada en vidrio soplado. Su cableado interno permite combinar los tres tamaños entre sí para crear múltiples composiciones empleando una única toma eléctrica. La ligereza de su estructura permite crear grandes volúmenes sin recargar el espacio.

Crosshatch C ist eine Deckenleuchte, die aus einer Metallgitterstruktur besteht und in drei Größen (S, M und L) und Lichtquelle aus geblasenem Glas. Die interne Verkabelung erlaubt die Kombination der drei Größen, sodass verschiedene Kompositionen an einer einzigen Steckdose kreiert werden können. Die Leichtigkeit der Struktur ermöglicht die Erschaffung großvolumiger Elemente, ohne den Raum zu überladen.





# Crosshatch

Decorative lighting

Ceiling lamps



CROSSHATCH C/W - S

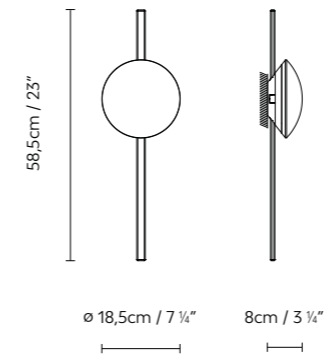

CROSSHATCH C/W - M

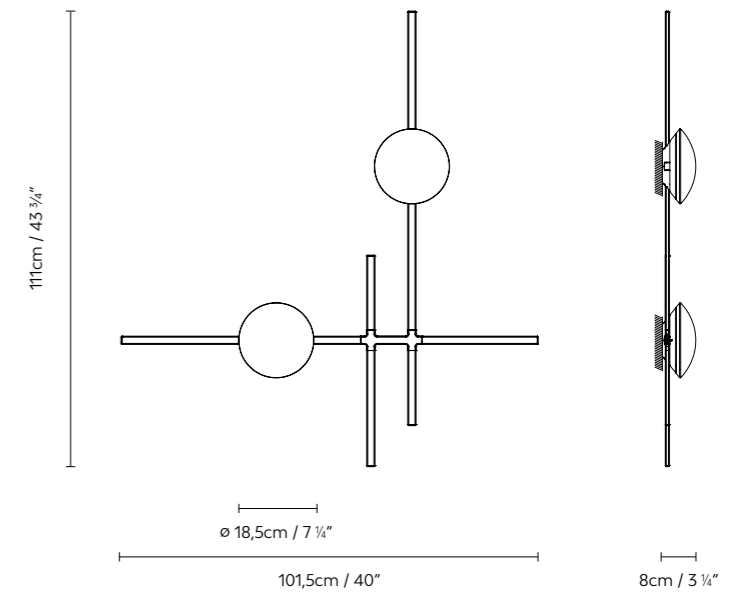

CROSSHATCH C/W - L

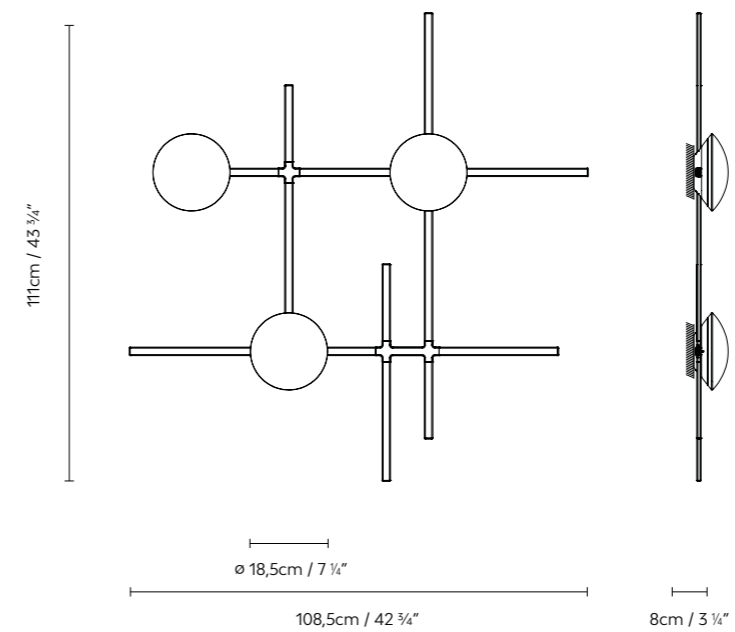

INSTALLATION EXAMPLE

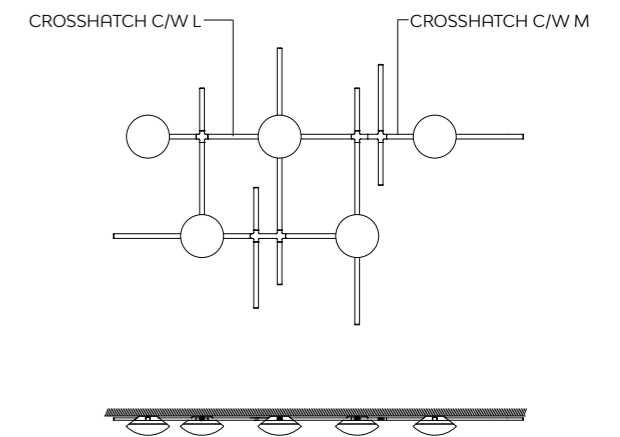

● Black (matte)

767100  
767110  
767120

**CROSSHATCH C/W - S**  
**CROSSHATCH C/W - M**  
**CROSSHATCH C/W - L**

LED 16W 1405lm 2700K CRI≥90 230V DIM PHASE CUT  
2 x LED 16W 2810lm 2700K CRI≥90 230V DIM PHASE CUT  
3 x LED 16W 4215lm 2700K CRI≥90 230V DIM PHASE CUT





**B.lux**

# Crosshatch W

by  
**Brad Ascalon**

**Decorative  
lighting**

Wall  
lamps

Crosshatch W is a wall light comprised of a metal grid structure available in three formats (S, M and L) and a light source made of blown glass. Its internal wiring means the three sizes can be combined with one another to create multiple compositions using a single connection. The lightness of its structure enables the creation of large volumes without overloading the space. There is a shelf accessory available which allows it to be positioned in multiple layouts. The Crosshatch Number option allows us to add numbers to the luminaire. This solution is focused on the hospitality market.

Crosshatch W es un aplique formado por una estructura reticular metálica disponible en tres formatos (S, M y L) y fuente de luz fabricada en vidrio soplado. Su cableado interno permite combinar los tres tamaños entre sí para crear múltiples composiciones empleando una única toma eléctrica. La ligereza de su estructura permite crear grandes volúmenes sin recargar el espacio. Hay disponible un accesorio de estantería que permite ubicarla en múltiples disposiciones. También está disponible la opción Crosshatch Number, orientada al sector hotelero, que permite personalizar la luminaria con números.

Crosshatch W ist eine Wandleuchte, die aus einer Metallgitterstruktur besteht und in drei Größen (S, M und L) und Lichtquelle aus geblasenem Glas. Die interne Verkabelung erlaubt die Kombination der drei Größen, sodass verschiedene Kompositionen an einer einzigen Steckdose kreiert werden können. Die Leichtigkeit der Struktur ermöglicht die Erschaffung großvolumiger Elemente, ohne den Raum zu überladen. Als Zubehör ist ein Regal erhältlich, mit dessen Hilfe die Leuchte in vielfältigen Anordnungen positioniert werden kann. Auch erhältlich in der Variante Option Crosshatch Number für den Hotelsektor, welche die Personalisierung der Leuchte mit Nummern ermöglicht.







Decorative lighting

Wall lamps

CROSSHATCH C/W - S

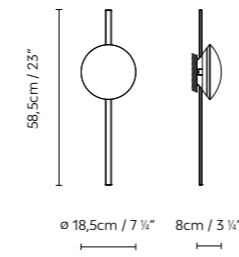

CROSSHATCH C/W - M

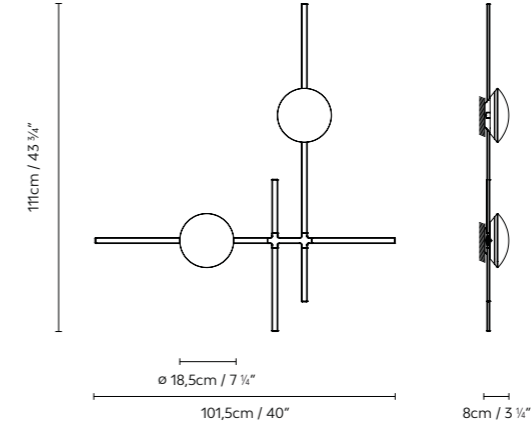

CROSSHATCH C/W - L

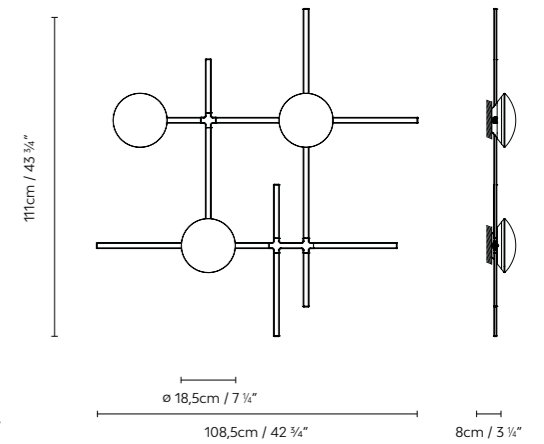

CROSSHATCH NUMBER

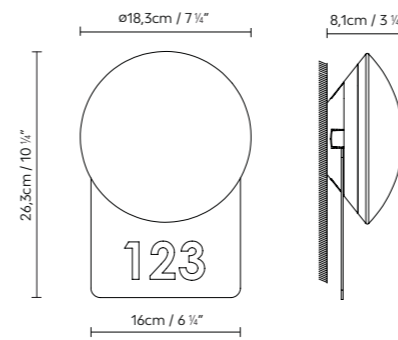

INSTALLATION EXAMPLE

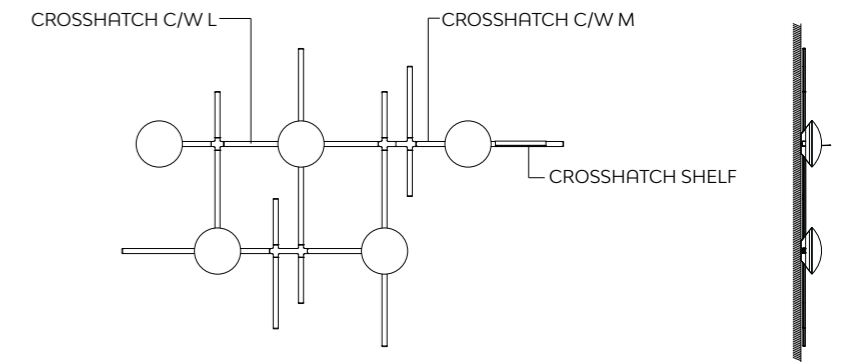

● Black (matte) ● Brass (Crosshatch Number)

767100	<b>CROSSHATCH C/W - S</b>	LED 16W 1405lm 2700K CRI≥90 230V DIM PHASE CUT
767110	<b>CROSSHATCH C/W - M</b>	2 x LED 16W 2810lm 2700K CRI≥90 230V DIM PHASE CUT
767120	<b>CROSSHATCH C/W - L</b>	3 x LED 16W 4215lm 2700K CRI≥90 230V DIM PHASE CUT
767980	<b>CROSSHATCH SHELF</b>	
767961	<b>CROSSHATCH NUMBER BLACK</b>	LED 10W 895lm 2700K CRI≥90 230V DIM PHASE CUT
767962	<b>CROSSHATCH NUMBER BRASS</b>	

\*Braille option available under request.





B.lux

# Micro

by  
David Abad

Decorative  
lighting

lamps

Metal suspension lamp with a direct light. Available in different matte finishes: *Black, White, Brass, Mustard, Lemon, Mango, Pearl, Orange, Burgundy, Rose, Red, Aqua, River, Horizon, Turquoise, Forest, Khaki, Silex, Concret, Limestone, Grey, Brown, Snow and Terracotta*. Direct light. Available in three finishes.

Luminaria de suspensión metálica de luz directa. Disponible en diferentes acabados mate: *Black, White, Brass, Mustard, Lemon, Mango, Pearl, Orange, Burgundy, Rose, Red, Aqua, River, Horizon, Turquoise, Forest, Khaki, Silex, Concret, Limestone, Grey, Brown, Snow y Terracotta*. Luz directa. Disponible en tres tamaños.

Metallhängeleuchte. Direkte Beleuchtung. Verfügbar in verschiedenen Ausfertigungen in matt: *Black, White, Brass, Mustard, Lemon, Mango, Pearl, Orange, Burgundy, Rose, Red, Aqua, River, Horizon, Turquoise, Forest, Khaki, Silex, Concret, Limestone, Grey, Brown, Snow und Terracotta*. Direkte Beleuchtung. Lieferbar in drei Größen.

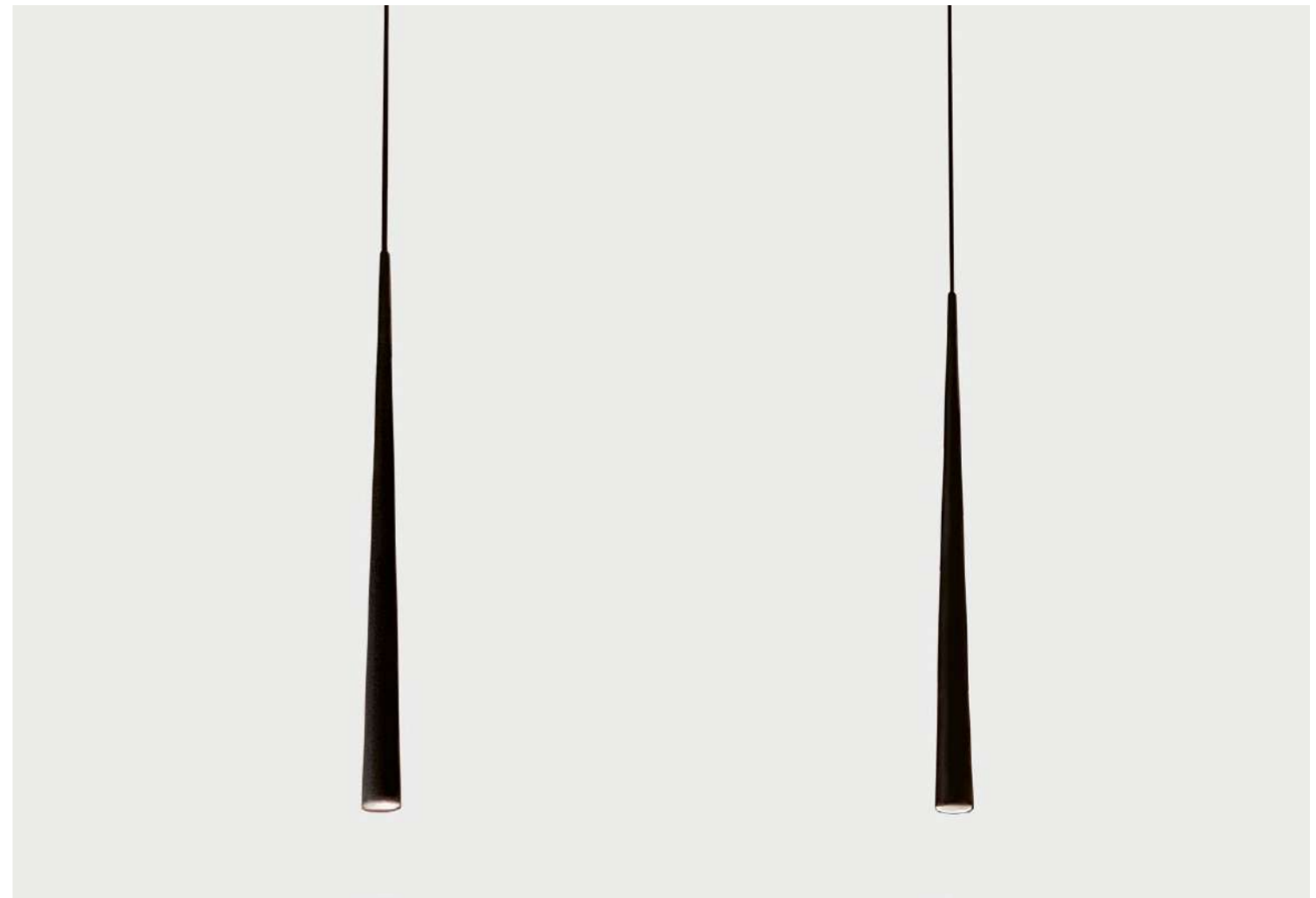

MICRO S50

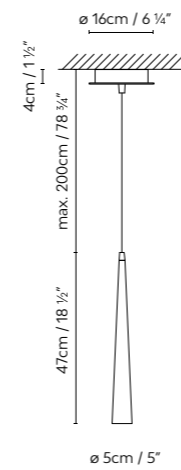

MICRO S75

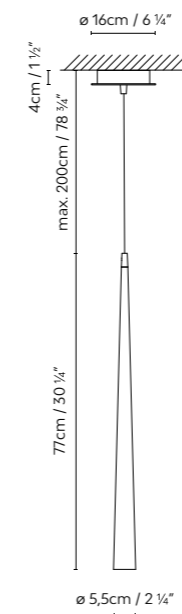

MICRO S OVERSIZE

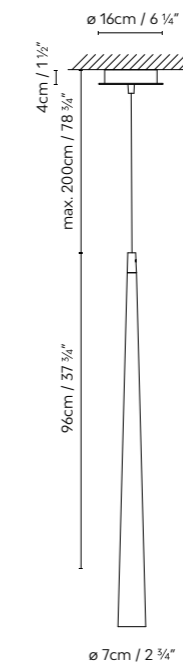

Check out your colour at  
[www.bluxlighting.com](http://www.bluxlighting.com)

● Black (matte)	○ White (matte)
● Brass (matte)	● Horizon (matte) RAL 5023
● Mustard (matte) RAL 1012	● Turquoise (matte) RAL 6034
● Lemon (matte) RAL 1018	● Forest (matte) RAL 6035
● Mango (matte) RAL 1034	● Khaki (matte) RAL 7008
● Pearl (matte) RAL 1035	● Silex (matte) RAL 7032
● Orange (matte) RAL 2013	● Concret (matte) RAL 7033
● Burgundy (matte) RAL 3011	● Limestone (matte) RAL 7035
● Rose (matte) RAL 3015	● Grey (matte) RAL 7037
● Red (matte) RAL 3020	● Brown (matte) RAL 8025
● Aqua (matte) RAL 5024	● Snow (matte) RAL 9003
● River (matte) RAL 5017	● Terracotta (matte)

716300 **MICRO S50 BLACK**  
716301 **MICRO S50 WHITE**  
716301+C **MICRO S50 +**  
LED 6,3W 540lm 350mA  
2700K CRI≥90 110-230V

716310 **MICRO S75 BLACK**  
716311 **MICRO S75 WHITE**  
716311+C **MICRO S75 +**  
LED 8,8W 770lm 250mA  
2700K CRI≥90 230V

716320 **MICRO S OVERSIZE BLACK**  
716321 **MICRO S OVERSIZE WHITE**  
716321+C **MICRO S OVERSIZE +**  
LED 8,8W 770lm 250mA  
2700K CRI≥90 230V

\*+C: select colour





B.lux

# Misko SH

by  
Stone Designs

Decorative  
lighting

lamps



A horizontal suspended luminaire inspired by Japanese design. It is created from a metal structure that holds two or three shades. The lower closure and upper ring are available in a natural walnut or matte black finish, and support the textured blown glass diffuser, which has a matte white opal finish. The glass is available in three sizes (15, 25 and 35), allowing for multiple compositions with two or three glass diffusers. Black textile cable.

Luminaria de suspensión horizontal, de inspiración japonesa. Se crea a partir de una estructura metálica en la que se reciben 2 o 3 pantallas. El cierre inferior y anillo superior están disponibles en acabado nogal natural o pintado en negro mate, y da soporte al difusor de vidrio soplado texturado, que presenta un acabado blanco mate opal. Los vidrios están disponibles en tres tamaños (15, 25 y 35) y permiten realizar múltiples composiciones con dos o tres difusores de vidrio. Cable textil negro.

Japanisch inspirierte horizontale Pendelleuchte. Der Ausgangspunkt ist eine Metallstruktur mit 2 oder 3 Schirmen. Der untere Abschluss und obere Ring sind erhältlich in den Ausführungen Natur-Nussbaum oder mattschwarz lackiert und halten den Diffusor aus mundgeblasenem, strukturiertem Glas mit mattweißer, opalisierter Oberfläche. Die Gläser sind in drei Größen (15, 25 und 35) erhältlich und ermöglichen mehrere Kompositionen mit zwei oder drei Glasdiffusoren. Schwarzes Textilkabel.

## MISKO SH 2

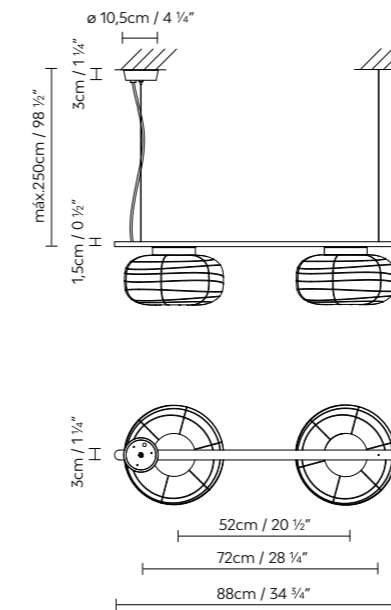

## MISKO SH 3

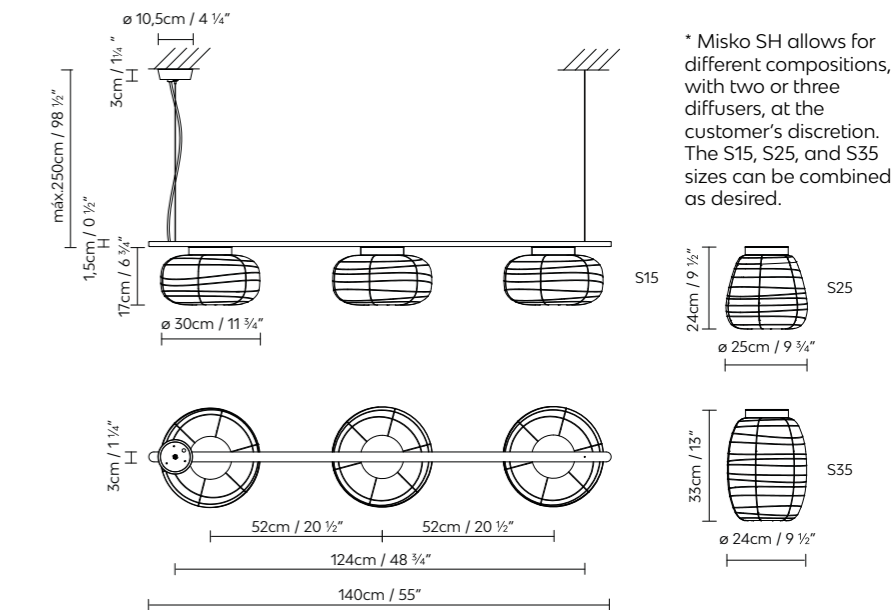

\* Misko SH allows for different compositions, with two or three diffusers, at the customer's discretion. The S15, S25, and S35 sizes can be combined as desired.

● Black (matte) ● Natural Walnut

756335 **MISKO S15** BLACK INFERIOR  
756336 **MISKO S25** BLACK INFERIOR  
756337 **MISKO S35** BLACK INFERIOR

LED 10W (E27)

756333 **MISKO S15** WALNUT INFERIOR  
756334 **MISKO S25** WALNUT INFERIOR  
756335 **MISKO S35** WALNUT INFERIOR

LED 10W (E27)

756910 **MISKO SH2+**  
756920 **MISKO SH3+**





**B.lux**

# Ring S

by  
**ILMIODESIGN**

**Decorative  
lighting**

lamps

Ring S is a collection of pendant lights made of metal and blown glass with one head (S1), two heads (S2, with multiple arm lengths) or six heads (S6). Ring S6 allows the arms to be installed at different heights in order to give the luminaire the desired volume. Ring's double diffuser emits completely uniform light and illuminates both sides of the ring. Its E14 light source allows the user to freely select the tone of light that best suits their installation space. Finishes: White, black and brass.

Ring S es una colección de suspensiones fabricadas en metal y vidrio soplado, de una cabeza (S1), dos cabezas (S2, con múltiples largos de brazo) o de seis cabezas (S6). Ring S6 permite instalar los brazos a diferentes alturas para dotar a la luminaria del volumen que se desee. El doble difusor de Ring emite una luz totalmente uniforme y da luz a ambos lados del anillo. Su fuente de luz E14 hace posible que el usuario elija libremente el tono de luz que mejor se adapte a su instalación. Acabados: Blanco, negro y latón.

Ring S ist eine Kollektion von Aufhängungen aus Metall und mundgeblasenem Glas, mit einem Kopf (S1), zwei Köpfen (S2, mit mehreren Armlängen) oder sechs Köpfen (S6). Ring S6 ermöglicht die Montage der Arme auf verschiedenen Höhen, um der Leuchte das gewünschte Volumen zu verleihen. Der doppelte Diffusor gibt ein völlig gleichmäßiges Licht ab und beleuchtet beide Seiten des Rings. Die E14-Lichtquelle ermöglicht es dem Benutzer, die für die jeweilige Anwendung am besten geeignete Lichtfarbe frei zu wählen. Ausführungen: Weiß, Schwarz und Messing.





**RING S1**

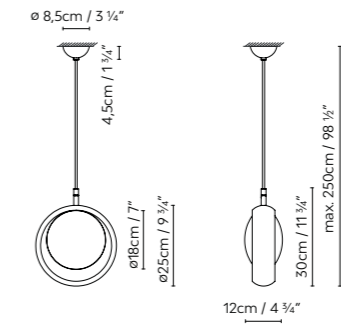

**RING S6**

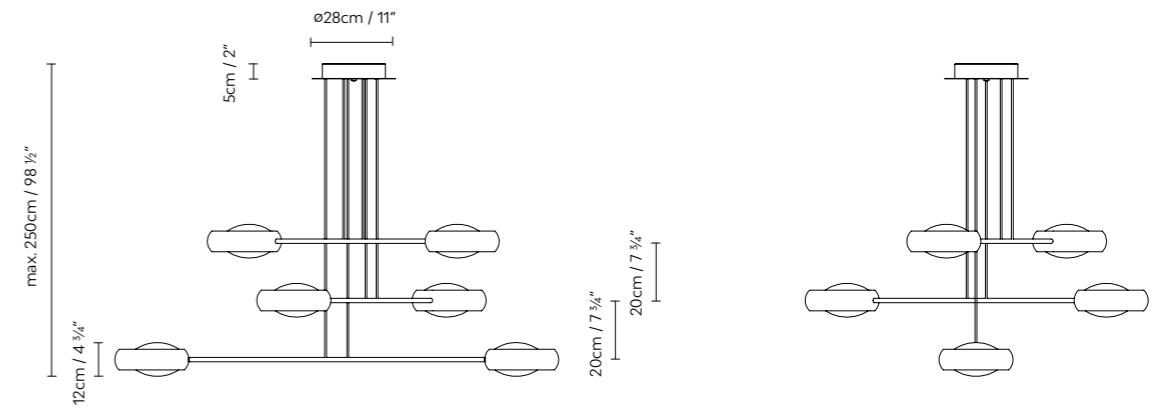
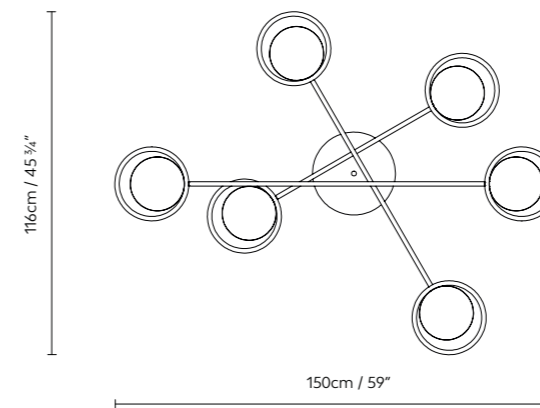

- Black (matte)
- Brass (matte)
- White (matte)

765300	<b>RING S1 BLACK</b>	LED 2 x 6W (E14) 230V 50-60Hz
765301	<b>RING S1 BRASS</b>	
765302	<b>RING S1 WHITE</b>	
765303	<b>RING S6 BLACK</b>	LED 12 x 6W (E14) 230V 50-60Hz
765304	<b>RING S6 BRASS</b>	
765305	<b>RING S6 WHITE</b>	







RING S2 110/130/150

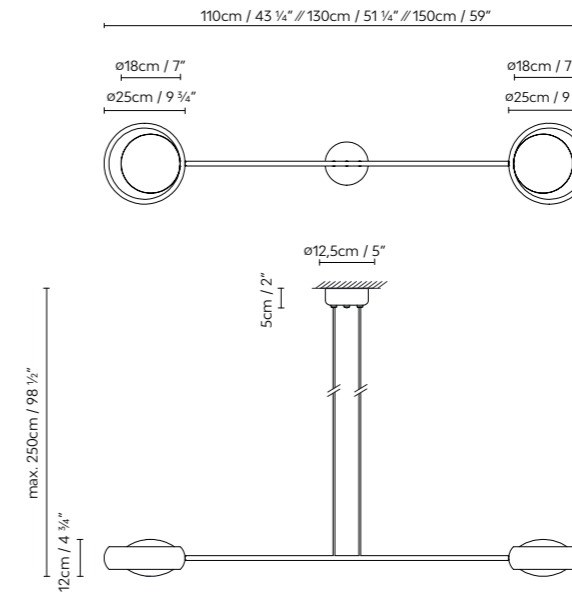

- Black (matte)
- Brass (matte)
- White (matte)

765306	<b>RING S2 110 BLACK</b>	LED 4 x 6W (E14) 230V 50-60Hz
765307	<b>RING S2 110 BRASS</b>	
765308	<b>RING S2 110 WHITE</b>	
765309	<b>RING S2 130 BLACK</b>	LED 4 x 6W (E14) 230V 50-60Hz
765310	<b>RING S2 130 BRASS</b>	
765311	<b>RING S2 130 WHITE</b>	
765312	<b>RING S2 150 BLACK</b>	LED 4 x 6W (E14) 230V 50-60Hz
765313	<b>RING S2 150 BRASS</b>	
765314	<b>RING S2 150 WHITE</b>	

**B.lux**

# Ring F

by  
**ILMIODESIGN**

**Decorative  
lighting**

lamps

Ring F is a floor light manufactured in metal and blown glass. Its double diffuser emits completely uniform light and illuminates both sides of the ring. Its E14 light source allows the user to freely select the tone of light that best suits their installation space. Finishes: White, black and brass/black.

Ring F es una luminaria de pie fabricada en metal y vidrio soplado. Su doble difusor emite una luz totalmente uniforme y da luz a ambos lados del anillo. Su fuente de luz E14 hace posible que el usuario elija libremente el tono de luz que mejor se adapte a su instalación. Acabados: Blanco, negro y latón/negro.

Ring F ist eine Stehleuchte aus Metall und geblasenem Glas. Ihr doppelter Diffusor gibt ein völlig gleichmäßiges Licht ab und beleuchtet beide Seiten des Rings. Die E14-Lichtquelle ermöglicht es dem Benutzer, die für die jeweilige Anwendung am besten geeignete Lichtfarbe frei zu wählen. Ausführungen: Weiß, Schwarz und Messing/Schwarz.

**RING F**

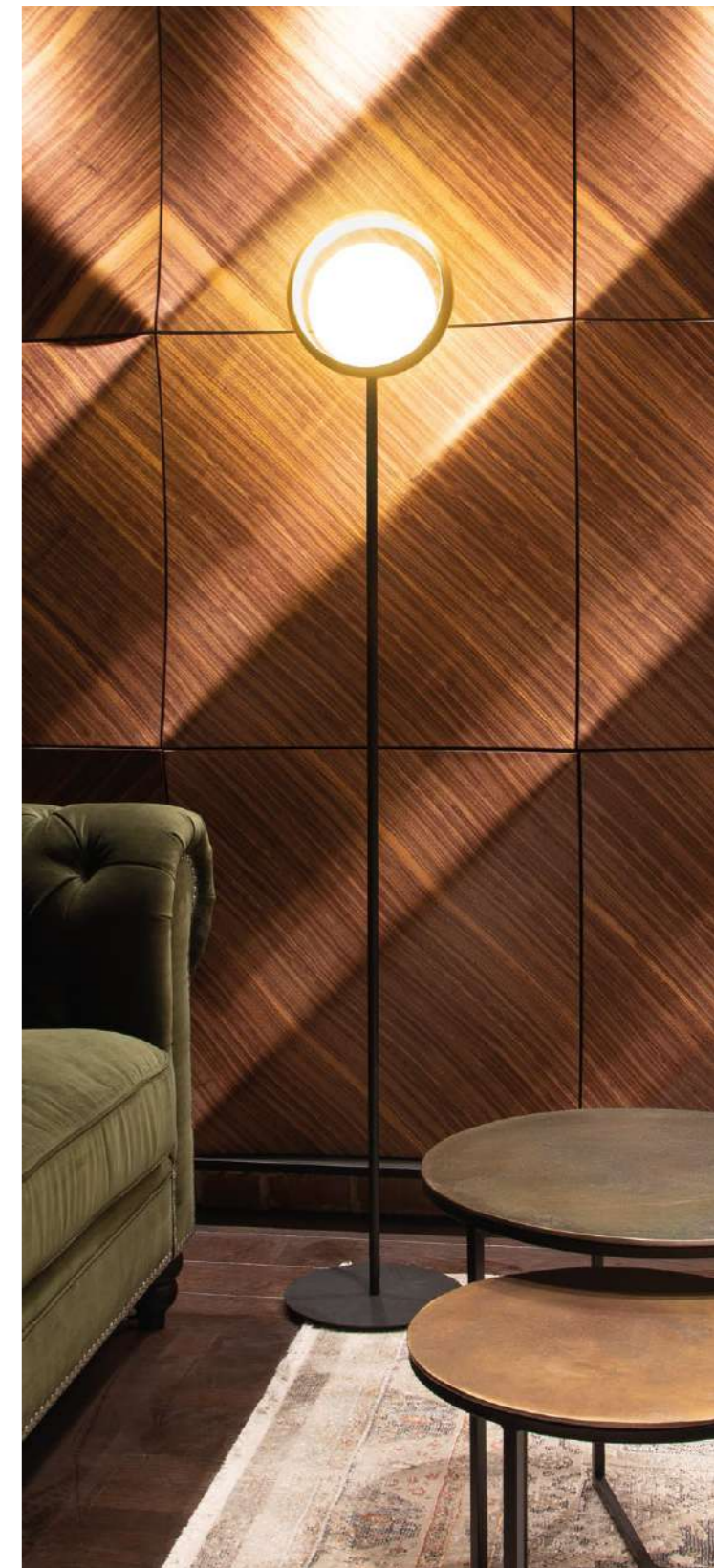
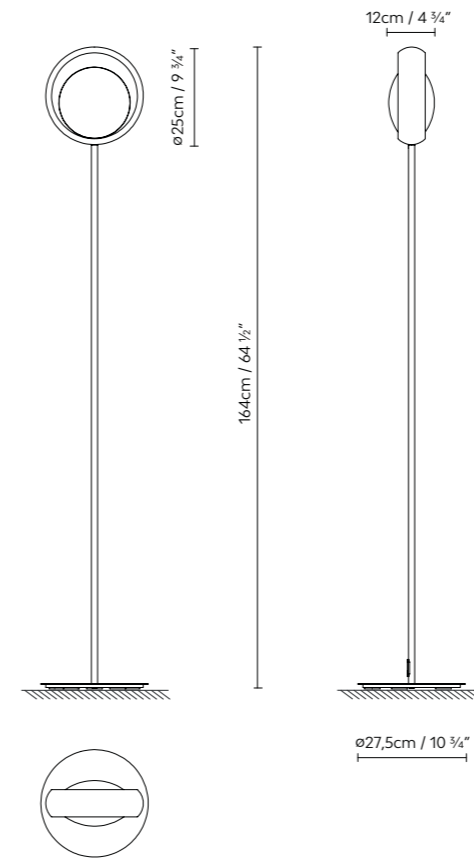

● Black (matte) ○ White (matte) ● Brass (matte)

765200 **RING F BLACK**  
765201 **RING F BRASS**  
765202 **RING F WHITE** LED 2 x 6W (E14)





B.lux

# Ring T

by  
ILMIODESIGN

Decorative  
lighting

Table  
lamps

Ring T is a table lamp made of metal and blown glass. Its double diffuser emits completely uniform light and illuminates both sides of the ring. Its E14 light source allows the user to freely select the tone of light that best suits their installation space. Finishes: White, black and brass/black.

Ring T es una luminaria de mesa fabricada en metal y vidrio soplado. Su doble difusor emite una luz totalmente uniforme y da luz a ambos lados del anillo. Su fuente de luz E14 hace posible que el usuario elija libremente el tono de luz que mejor se adapte a su instalación. Acabados: Blanco, negro y latón/negro.

Ring T ist eine Tischleuchte aus Metall und geblasenem Glas. Ihr doppelter Diffusor gibt ein völlig gleichmäßiges Licht ab und beleuchtet beide Seiten des Rings. Die E14-Lichtquelle ermöglicht es dem Benutzer, die für die jeweilige Anwendung am besten geeignete Lichtfarbe frei zu wählen. Ausführungen: Weiß, Schwarz und Messing/Schwarz.



## RING T

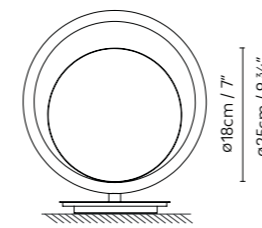

12cm / 4 3/4"

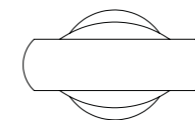
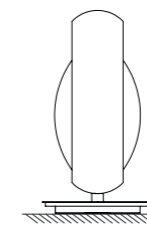

● Black (matte)    ○ White (matte)    ● Brass (matte)

765000 **RING T BLACK**  
765001 **RING T BRASS**    LED 2 x 6 W (E14)  
765002 **RING T WHITE**

B.lux

# Ring C

by  
ILMIODESIGN

Decorative  
lighting

lamps

Ring C is a ceiling light manufactured in metal and blown glass. Its diffuser emits fully uniform light and also creates a gentle perimeter glow around the luminaire. Its E27 light source allows the user to freely select the tone of light that best suits their installation space. Finishes: White, black and brass. Option of colour customisation.

Ring C es un plafón fabricado en metal y vidrio soplado. Su difusor emite una luz totalmente uniforme y crea además un suave resplandor perimetral que rodea la luminaria. Su fuente de luz E27 hace posible que el usuario elija libremente el tono de luz que mejor se adapte a su instalación. Acabados: Blanco, negro y latón. Posibilidad de customizar colores.

Ring C ist eine Deckenleuchte aus Metall und geblasenem Glas. Ihr Diffusor gibt ein völlig gleichmäßiges Licht ab und erzeugt außerdem einen weichen Lichtschein um die Leuchte herum. Die E27-Lichtquelle ermöglicht es dem Benutzer, die für die jeweilige Anwendung am besten geeignete Lichtfarbe frei zu wählen. Ausführungen: Weiß, Schwarz und Messing. Möglichkeit der individuellen Farbgestaltung.



## RING C45

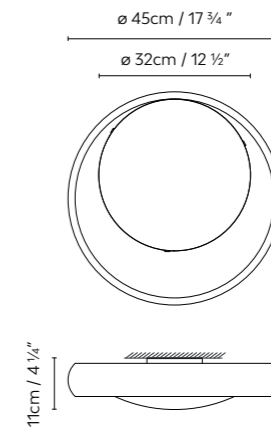

- |                             |                              |                              |                          |
|-----------------------------|------------------------------|------------------------------|--------------------------|
| ● Black (matte)             | ● Brass (matte)              | ○ White (matte)              |                          |
| ● Mustard (matte) RAL 1012  | ● Rose (matte) RAL 3015      | ● Forest (matte) RAL 6035    | ● Brown (matte) RAL 8025 |
| ● Lemon (matte) RAL 1018    | ● Red (matte) RAL 3020       | ● Khaki (matte) RAL 7008     | ○ Snow (matte) RAL 9003  |
| ● Mango (matte) RAL 1034    | ● Aqua (matte) RAL 5024      | ● Silex (matte) RAL 7032     | ● Terracotta (matte)     |
| ● Pearl (matte) RAL 1035    | ● River (matte) RAL 5017     | ● Concret (matte) RAL 7033   |                          |
| ● Orange (matte) RAL 2013   | ● Horizon (matte) RAL 5023   | ● Limestone (matte) RAL 7035 |                          |
| ● Burgundy (matte) RAL 3011 | ● Turquoise (matte) RAL 6034 | ● Grey (matte) RAL 7037      |                          |

Check out your colour at  
[www.bluxlighting.com](http://www.bluxlighting.com)

765400	<b>RING C45 BLACK</b>	
765401	<b>RING C45 BRASS</b>	LED 2 x 10W (E27)
765402	<b>RING C45 WHITE</b>	

765405+C	<b>RING C45 +</b>	LED 2 x 10W (E27)
----------	-------------------	-------------------

\*+C: select colour





**B.lux**

# Ring W

by  
**ILMIODESIGN**

**Decorative  
lighting**

Wall  
lamps

Ring W is a wall light made of metal and blown glass. Its diffuser emits fully uniform light and also creates a gentle perimeter glow around the luminaire. Its E14 light source allows the user to freely select the tone of light that best suits their installation space. Finishes: White, black and brass. Option of colour customisation. The Ring Number option allows us to add numbers to the luminaire. This solution is focused on the hospitality market.

Ring W es un aplique fabricado en metal y vidrio soplado. Su difusor emite una luz totalmente uniforme y crea además un suave resplandor perimetral que rodea la luminaria. Su fuente de luz E14, hace posible que el usuario elija libremente el tono de luz que mejor se adapte a su instalación. Acabados: Blanco, negro y latón. Posibilidad de customizar en colores. También está disponible la opción Ring Number, orientada al sector hotelero, que permite personalizar la luminaria con números.

Ring W ist eine Wandleuchte aus Metall und geblasenem Glas. Ihr Diffusor gibt ein völlig gleichmäßiges Licht ab und erzeugt außerdem einen weichen Lichtschein um die Leuchte herum. Die E14-Lichtquelle ermöglicht es dem Benutzer, die für die jeweilige Anwendung am besten geeignete Lichtfarbe frei zu wählen. Ausführungen: Weiß, Schwarz und Messing. Möglichkeit der individuellen Farbgestaltung. Auch erhältlich in der Variante Option Ring Number für den Hotelsektor, welche die Personalisierung der Leuchte mit Nummern ermöglicht.



**RING W1**

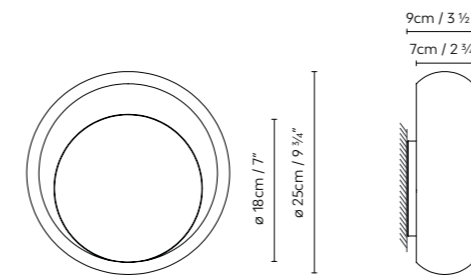

**RING W1 NUMBER**

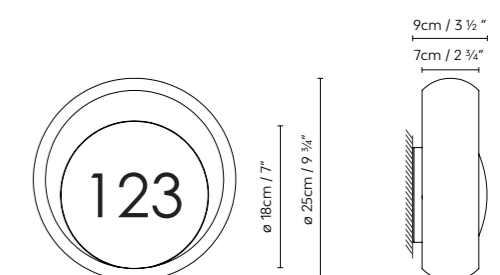

- Black (matte)
- White (matte)
- Brass (matte)
- Mustard (matte) RAL 1012
- Rose (matte) RAL 3015
- Forest (matte) RAL 6035
- Brown (matte) RAL 8025
- Lemon (matte) RAL 1018
- Red (matte) RAL 3020
- Khaki (matte) RAL 7008
- Snow (matte) RAL 9003
- Mango (matte) RAL 1034
- Aqua (matte) RAL 5024
- Silex (matte) RAL 7032
- Terracotta (matte)
- Pearl (matte) RAL 1035
- River (matte) RAL 5017
- Concret (matte) RAL 7033
- Orange (matte) RAL 2013
- Horizon (matte) RAL 5023
- Limestone (matte) RAL 7035
- Burgundy (matte) RAL 3011
- Turquoise (matte) RAL 6034
- Grey (matte) RAL 7037

Check out your colour at  
[www.bluxlighting.com](http://www.bluxlighting.com)

765100	<b>RING W1 BLACK</b>	LED 2 x 6W (E14) 230V 50-60Hz
765101	<b>RING W1 BRASS</b>	
765102	<b>RING W1 WHITE</b>	
765106+C	<b>RING W1+</b>	
765150+C	<b>RING W1 NUMBER</b>	LED 2 x 6W (E14) 230V 50-60Hz

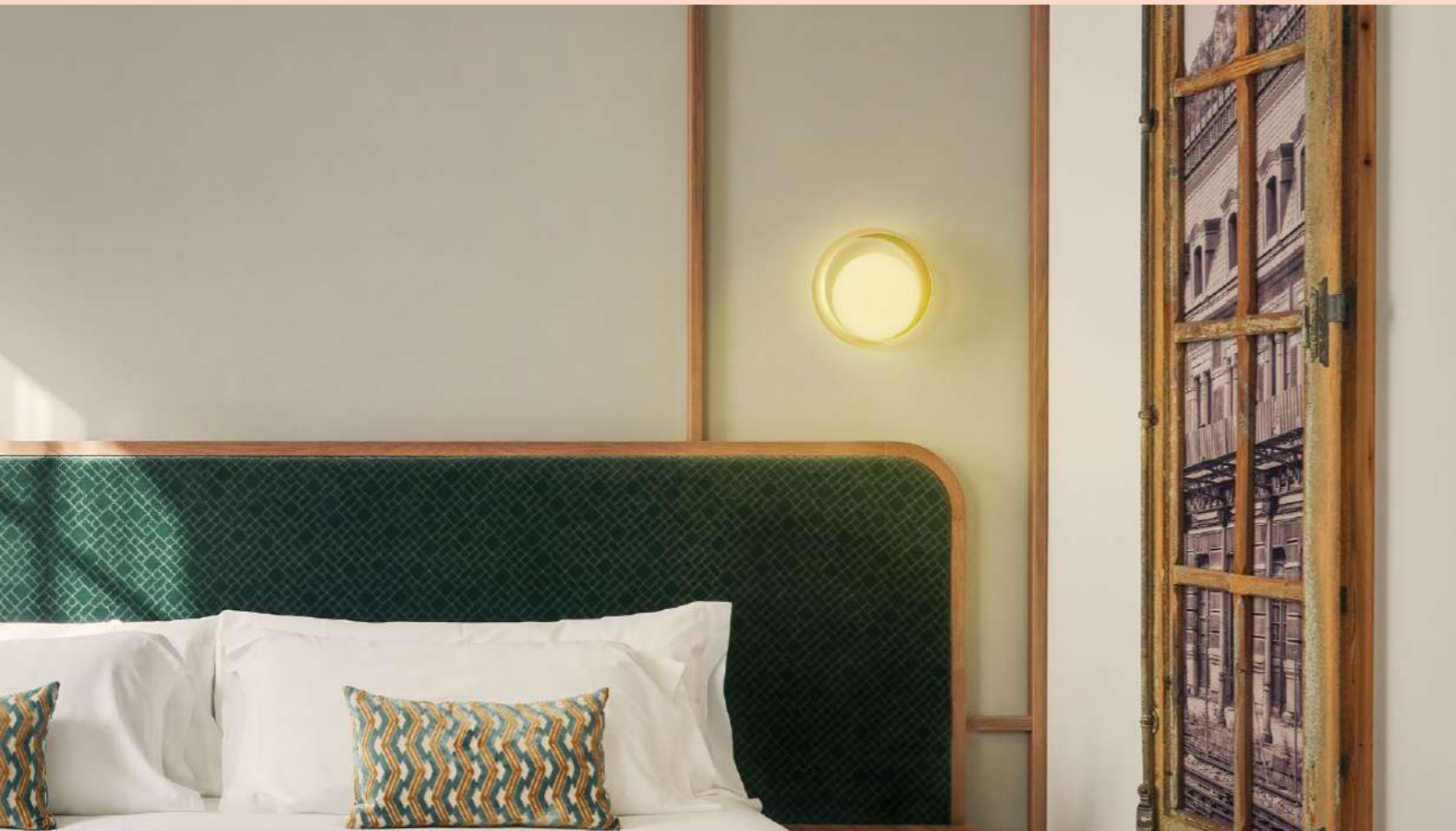

**B.lux**

# Slim Skin S

by  
**AIA Salazar-Navarro**

**Decorative  
lighting**

lamps

Slim Skin S is a collection of pendant luminaires that are installed horizontally (SH) or vertically (SV), available in two sizes (700 and 1400). It is manufactured in glass, polycarbonate and metal mesh. Its lighting cylinder is available in an opal finish (opal PMMA material) or transparent finish (striated glass). Its metal mesh overlay is available in a brass or black finish. This mesh generates a moiré effect, thereby preventing any glare and offering great visual comfort.

Slim Skin S es una colección de luminarias de suspensión de instalación horizontal (SH) o vertical (SV), disponible en dos tamaños (700 y 1400). Está fabricada en vidrio, policarbonato y malla metálica. Su cilindro lumínico está disponible en los acabados opal (material PMMA opalino) y transparente (cristal estriado). Su revestimiento de malla metálica está disponible en los acabados latón o negro. Esta malla genera un efecto moaré, evitando así cualquier deslumbramiento y transmitiendo un gran confort visual.

Slim Skin S ist eine in zwei Größen (700 und 1400) erhältliche Kollektion von Pendelleuchten für die horizontale (SH) oder vertikale (SV) Montage. Sie besteht aus Glas, Polycarbonat und Metallmaschen. Der Lichtzylinder ist in den Ausführungen opal (opalines PMMA-Material) und transparent (geriffeltes Glas) erhältlich. Die Verkleidung aus Metallmaschen ist in Messing oder schwarzer Ausführung erhältlich. Diese Maschen erzeugen einen Moiré-Effekt, der Blendung verhindert und für hohen Sehkombfort sorgt.



\*Installation using a custom remote driver.



Slim Skin

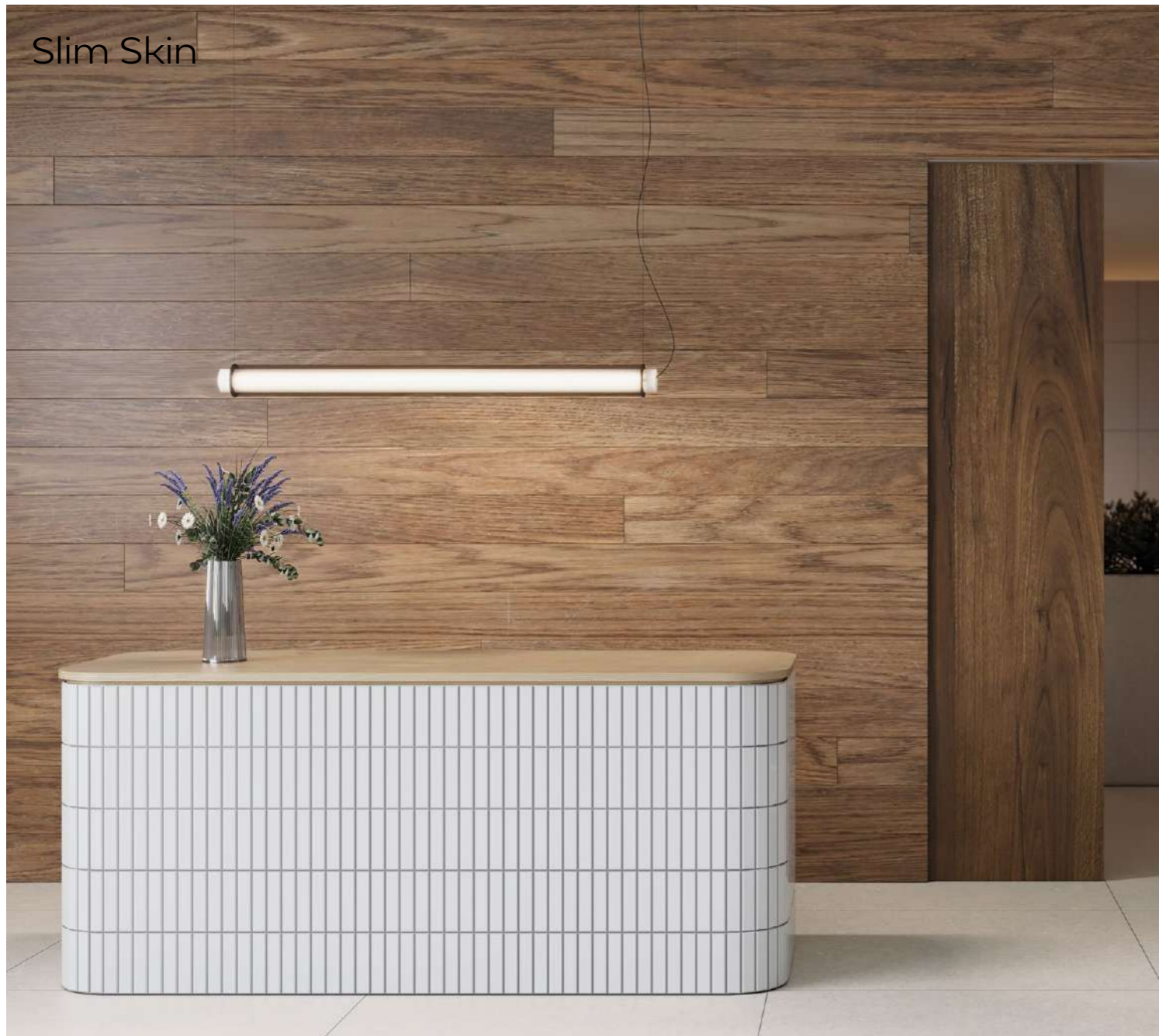

Decorative lighting

Suspension lamps

**SLIM SKIN SH 700**

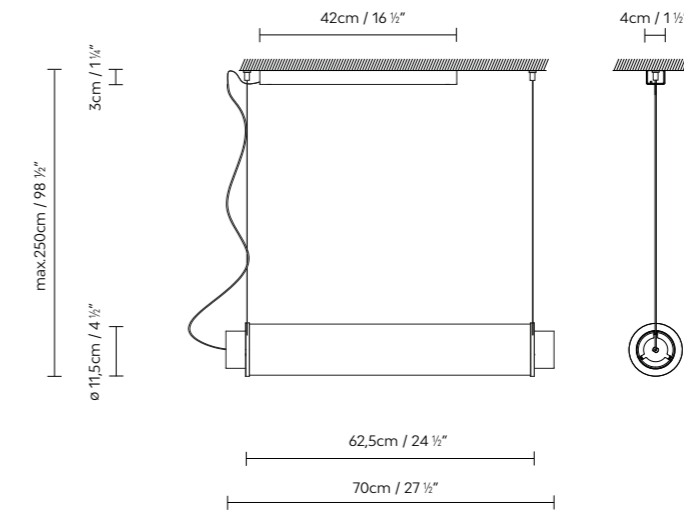

**SLIM SKIN SH 1400**

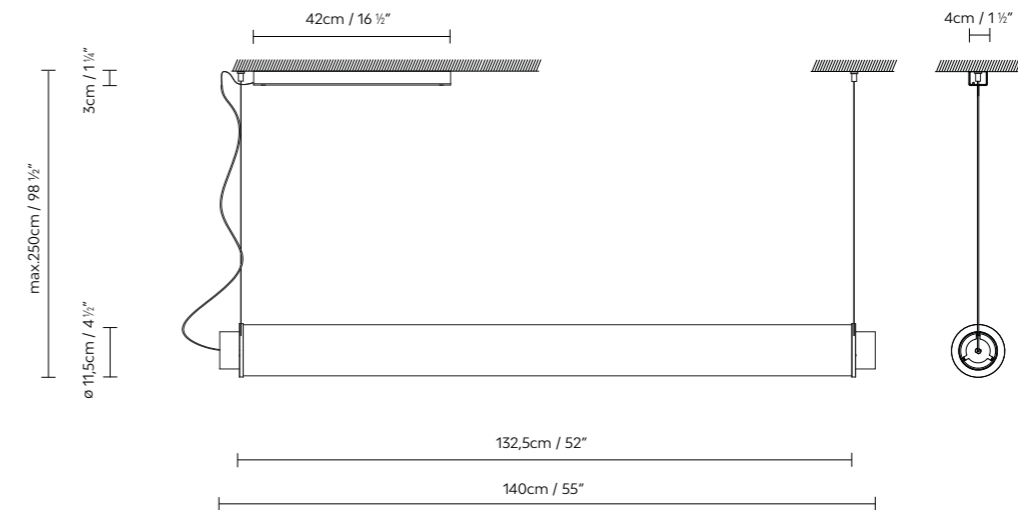

- Black (matte)
- Brass (matte)
- Opal PMMA
- Groove Glass

769300	<b>SLIM SKIN SH700</b> OPAL BLACK	LED 21W 3975lm 500mA 2700K CRI≥90 230V DIM PUSH/DALI
769302	<b>SLIM SKIN SH700</b> OPAL BRASS	
769320	<b>SLIM SKIN SH700</b> GROOVE BLACK	
769322	<b>SLIM SKIN SH700</b> GROOVE BRASS	
769310	<b>SLIM SKIN SH1400</b> OPAL BLACK	LED 42W 7950lm 1050mA 2700K CRI≥90 230V DIM PUSH/DALI
769312	<b>SLIM SKIN SH1400</b> OPAL BRASS	
769330	<b>SLIM SKIN SH1400</b> GROOVE BLACK	
769332	<b>SLIM SKIN SH1400</b> GROOVE BRASS	



# Slim Skin



Decorative lighting

Suspension lamps

## SLIM SKIN SV 700

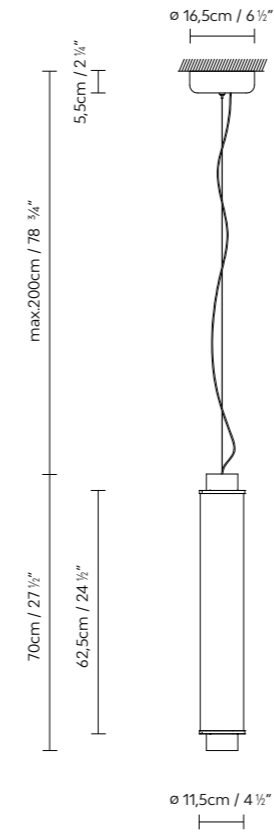

## SLIM SKIN SV 1400

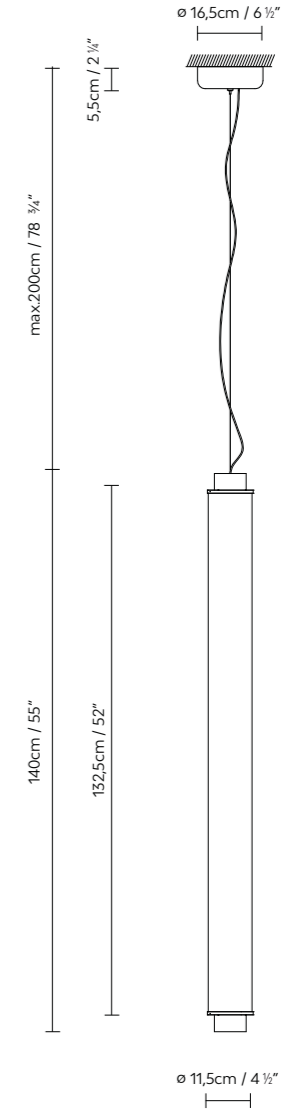

● Black (matte) ● Brass (matte) ○ Opal PMMA ☉ Groove Glass

769350	<b>SLIM SKIN SV700</b> OPAL BLACK	LED 21W 3975lm 500mA 2700K CRI≥90 230V DIM PUSH/DALI
769352	<b>SLIM SKIN SV700</b> OPAL BRASS	
769370	<b>SLIM SKIN SV700</b> GROOVE BLACK	
769372	<b>SLIM SKIN SV700</b> GROOVE BRASS	
769360	<b>SLIM SKIN SV1400</b> OPAL BLACK	LED 42W 7950lm 1050mA 2700K CRI≥90 230V DIM PUSH/DALI
769362	<b>SLIM SKIN SV1400</b> OPAL BRASS	
769380	<b>SLIM SKIN SV1400</b> GROOVE BLACK	
769382	<b>SLIM SKIN SV1400</b> GROOVE BRASS	

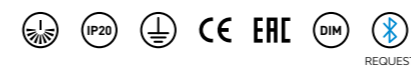

REQUEST



B.lux

# Slim Skin F

by  
AIA Salazar-Navarro

Decorative  
lighting

Floor  
lamps

Slim Skin F is a floor light manufactured in glass, opal polycarbonate and metal mesh. Its lighting cylinder is available in an opal finish (opal PMMA material) or transparent finish (striated glass). Its metal mesh overlay is available in a brass or black finish. This mesh generates a moiré effect, thereby preventing any glare and offering great visual comfort.

Slim Skin F es una luminaria de suelo fabricada en vidrio, policarbonato opal y malla metálica. Su cilindro lumínico está disponible en los acabados opal (material PMMA opalino) y transparente (cristal estriado). Su revestimiento de malla metálica está disponible en los acabados latón o negro. Esta malla genera un efecto moiré, evitando así cualquier deslumbramiento y transmitiendo un gran confort visual.

Slim Skin F ist eine Stehleuchte aus Glas, opalem Polycarbonat und Metallgeflecht. Der Lichtzylinder ist in den Ausführungen opal (opalines PMMA-Material) und transparent (geriffeltes Glas) erhältlich. Die Verkleidung aus Metallmaschen ist in Messing oder schwarzer Ausführung erhältlich. Diese Maschen erzeugen einen Moiré-Effekt, der Blendung verhindert und für hohen Sehkomfort sorgt.

SLIM SKIN F

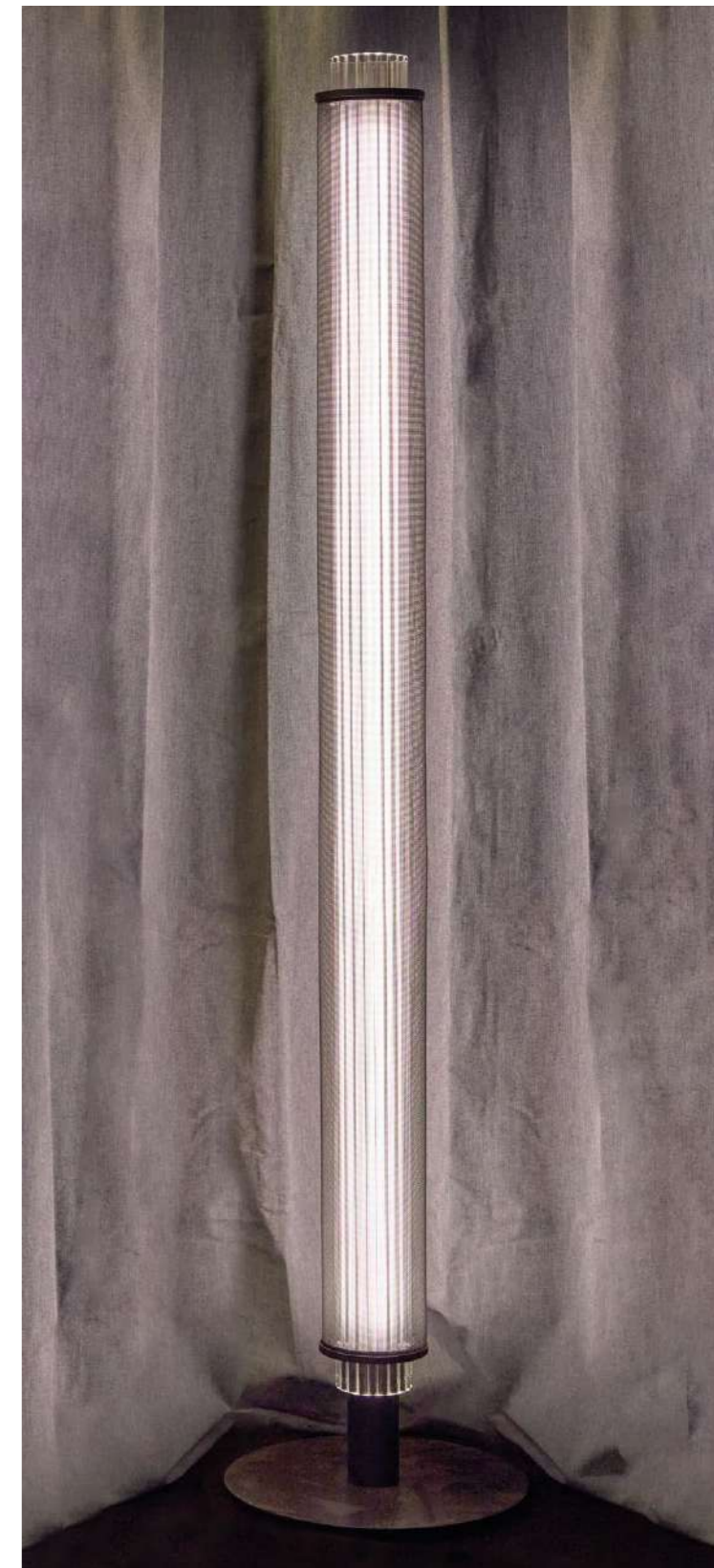
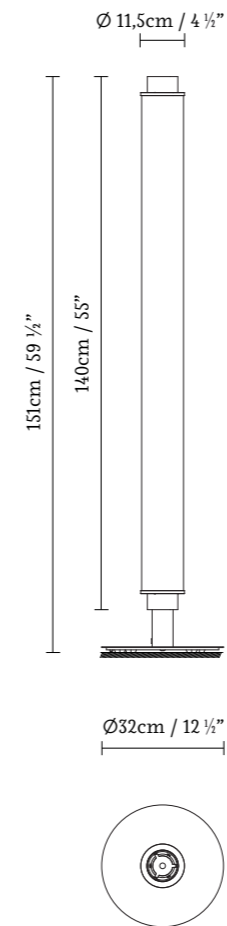

● Black (matte) ● Brass (matte) ○ Opal PMMA ◻ Groove Glass

769210  
769212  
769230  
769232

**SLIM SKIN F** OPAL BLACK  
**SLIM SKIN F** OPAL BRASS  
**SLIM SKIN F** GROOVE BLACK  
**SLIM SKIN F** GROOVE BRASS

LED 21W 3975lm 500mA 2700K CRI≥90 230V DIM PUSH/DALI



**B.lux**

# Slim Skin W

by  
**AIA Salazar-Navarro**

**Decorative  
lighting**

Wall  
lamps

Slim Skin W is a wall light available in two sizes (700 and 1400) and manufactured in glass, opal polycarbonate and metal mesh. Its lighting cylinder is available in an opal finish (opal PMMA material) or transparent finish (striated glass). Its metal mesh overlay is available in a brass or black finish. This mesh generates a moiré effect, thereby preventing any glare and offering great visual comfort.

Slim Skin W es un aplique disponible en dos tamaños (700 y 1400) fabricado en vidrio, policarbonato opal y malla metálica. Su cilindro lumínico está disponible en los acabados opal (material PMMA opalino) y transparente (cristal estriado). Su revestimiento de malla metálica está disponible en los acabados latón o negro. Esta malla genera un efecto moiré, evitando así cualquier deslumbramiento y transmitiendo un gran confort visual.

Slim Skin W ist eine in zwei Größen (700 und 1400) erhältliche Wandleuchte aus Glas, opalinem Polycarbonat und Metallmaschen. Der Lichtzylinder ist in den Ausführungen opal (opalines PMMA-Material) und transparent (geriffeltes Glas) erhältlich. Die Verkleidung aus Metallmaschen ist in Messing oder schwarzer Ausführung erhältlich. Diese Maschen erzeugen einen Moiré-Effekt, der Blendung verhindert und für hohen Sehkomfort sorgt.





# Slim Skin W



Decorative lighting

Wall lamps

## SLIM SKIN W700

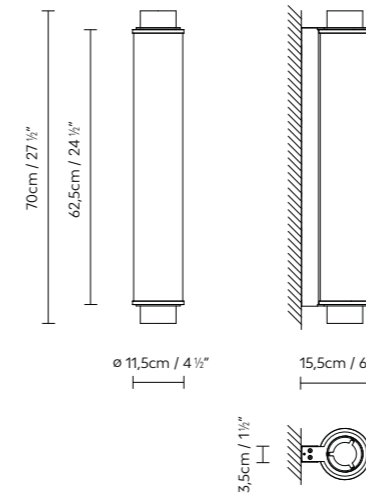

## SLIM SKIN W1400

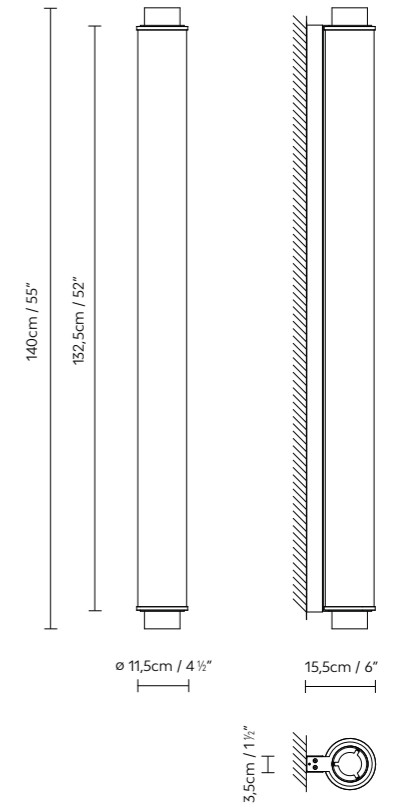

● Black (matte) ● Brass (matte) ○ Opal PMMA ◉ Groove Glass

769100	<b>SLIM SKIN W700</b> OPAL BLACK	LED 21W 3975lm 500mA 2700K CRI≥90 230V DIM PUSH/DALI
769102	<b>SLIM SKIN W700</b> OPAL BRASS	
769120	<b>SLIM SKIN W700</b> GROOVE BLACK	
769122	<b>SLIM SKIN W700</b> GROOVE BRASS	
769110	<b>SLIM SKIN W1400</b> OPAL BLACK	LED 42W 7950lm 1050mA 2700K CRI≥90 230V DIM PUSH/DALI
769112	<b>SLIM SKIN W1400</b> OPAL BRASS	
769130	<b>SLIM SKIN W1400</b> GROOVE BLACK	
769132	<b>SLIM SKIN W1400</b> GROOVE BRASS	





# Decorative systems





**B.lux**

# Crosshatch System

by  
**Brad Ascalon**

**Decorative  
lighting**

Lighting  
systems

Three-dimensional LED lighting system based on an aluminium profile, with lengths determined by the user, single or double cross-pieces and a light source made of blown glass. The combination of components allows for easy adaptation of the structure (the entire system is pre-wired) to the installation space. The light source, with a very low profile, comes with pre-wired quick terminals, enabling the entire structure to be powered through a single connection. Finished in textured matte black and matte opal white glass.

Sistema de iluminación LED tridimensional basado en un perfil de aluminio de longitudes a determinar por el usuario, cruceta simple, cruceta doble y fuente de luz fabricada en vidrio soplado. La combinación de los componentes permite al usuario adecuar la estructura de una forma sencilla (todo el sistema va precableado) al espacio donde se precise instalarlo. La fuente de luz, de altura muy contenida, está dotada de clemas rápidas precableadas, lo que permite dar corriente a toda la estructura a través de un único punto de corriente. Acabado en negro mate texturizado y cristal blanco opal mate.

Dreidimensionales LED-Beleuchtungssystem basierend auf einem Aluminiumprofil mit benutzerdefinierter Länge, einfachem Kreuzgelenk, doppeltem Kreuzgelenk und Lichtquelle aus geblasenem Glas. Die Kombination der Komponenten erleichtert dem Benutzer die Anpassung der Struktur (das gesamte System ist vorverkabelt) an den Raum, in dem es installiert werden soll. Die sehr niedrige Lichtquelle ist mit vorverkabelten Schnellklemmen ausgestattet, sodass die gesamte Struktur über eine einzige Steckdose mit Strom versorgt werden kann. Ausführung mit strukturierter mattschwarzer Oberfläche und opalisiertem mattweißem Glas.



# Crosshatch System

SINGLE CROSS

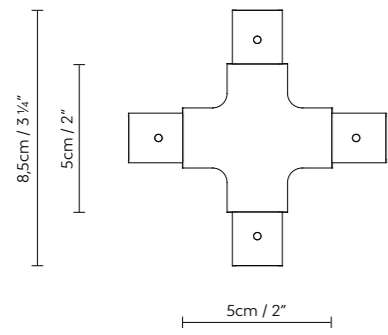

DOUBLE CROSS

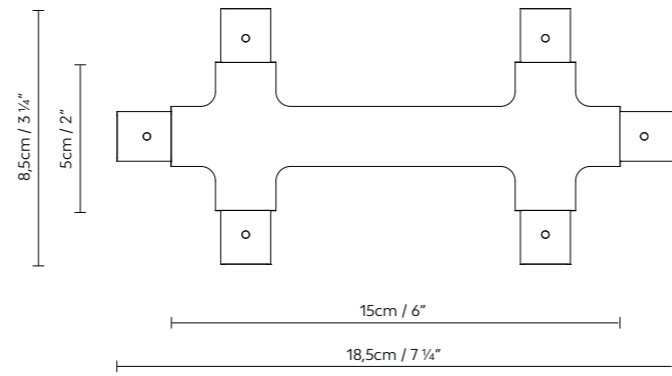

TUBE END CROSS

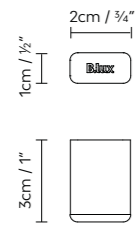

END CAP

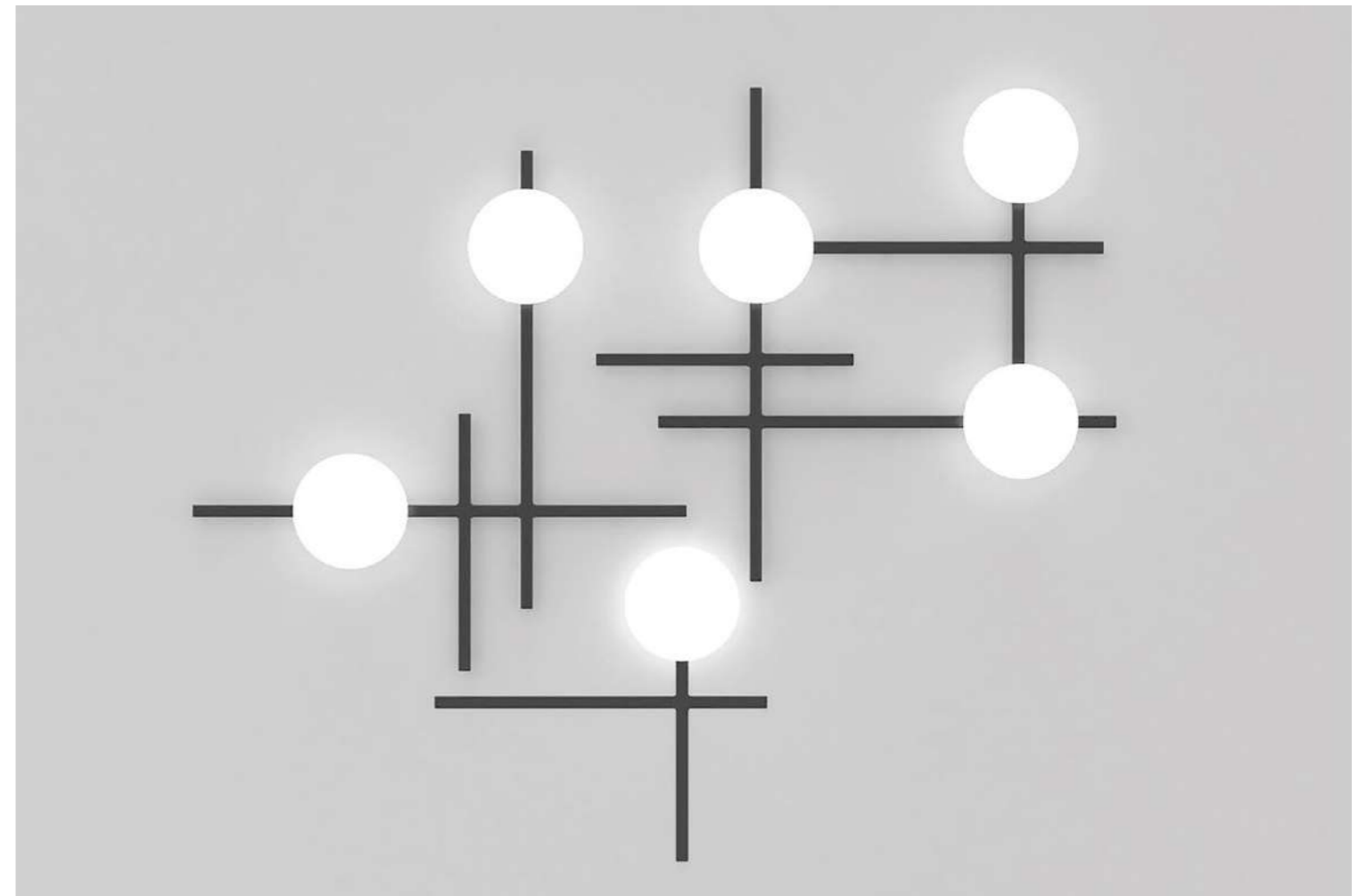
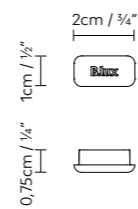

LINEAR UNION

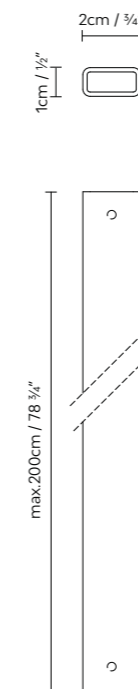

90° UNION C/W

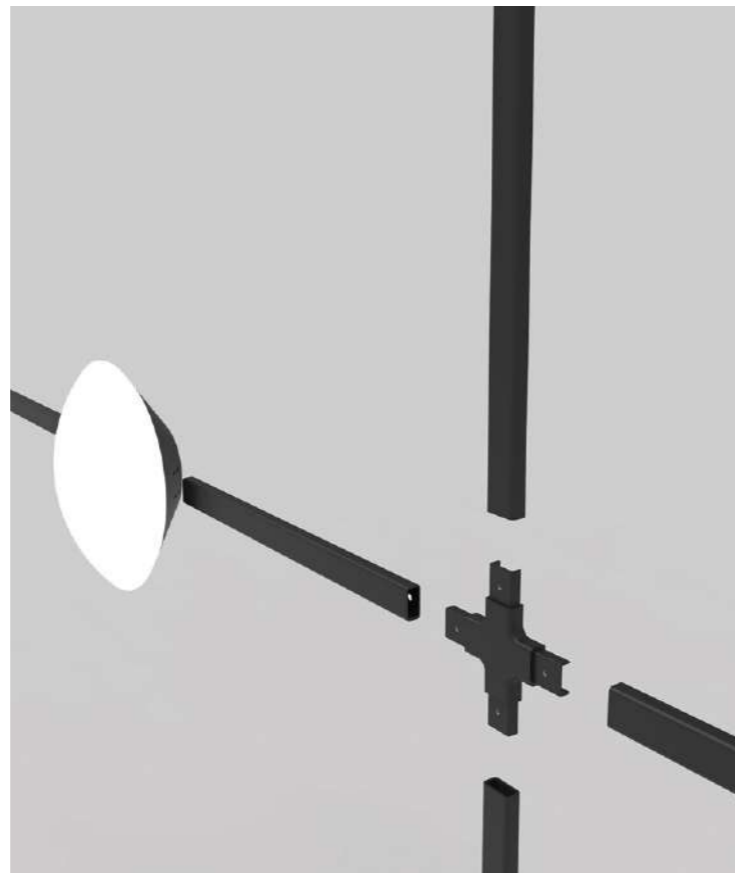
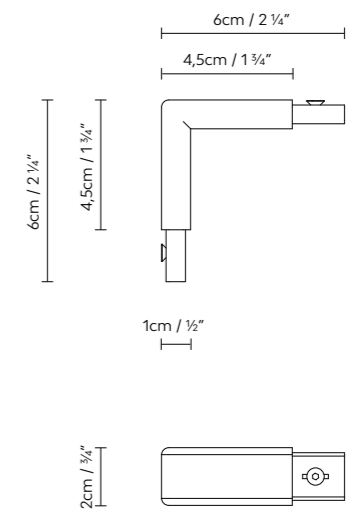



# Crosshatch System

Decorative  
lighting

Lighting  
systems



## SHELF

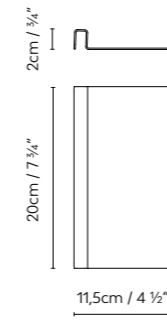

## LIGHT SOURCE

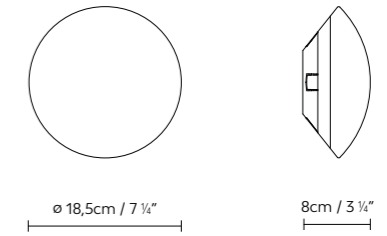

● Black (matte)

767960	<b>CROSSHATCH SYSTEM</b> LIGHT SOURCE
767910	<b>CROSSHATCH SYSTEM</b> SINGLE SUSPENSION
767504	<b>CROSSHATCH SYSTEM</b> TUBE END CROSS
767920	<b>CROSSHATCH SYSTEM</b> END CAP
767930	<b>CROSSHATCH SYSTEM</b> SINGLE CROSS
767940	<b>CROSSHATCH SYSTEM</b> DOUBLE CROSS
767950	<b>CROSSHATCH SYSTEM</b> 90° UNION C/W
767900	<b>CROSSHATCH SYSTEM</b> CURRENT SUPPLY
767970	<b>CROSSHATCH SYSTEM</b> LINEAR UNION
767800	<b>CROSSHATCH SYSTEM</b> TUBE SUPPORT ACCESSORY
767980	<b>CROSSHATCH SYSTEM</b> SHELF

LED 16W 1405lm 2700K CRI≥90 230V DIM PHASE CUT



## CROSSHATCH SYSTEM INSTALLATION EXAMPLES

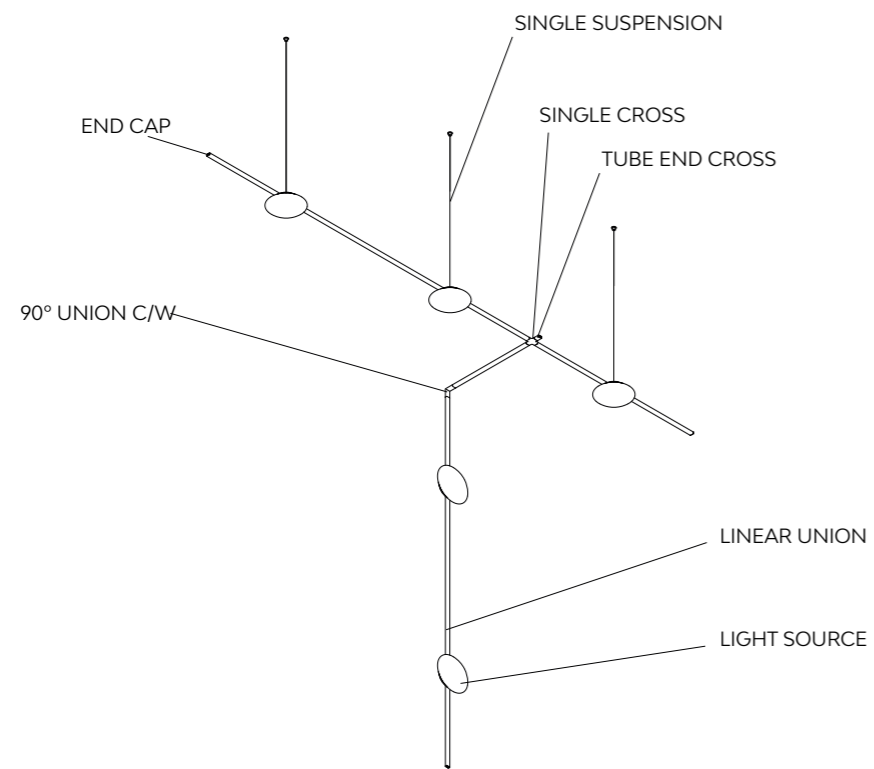
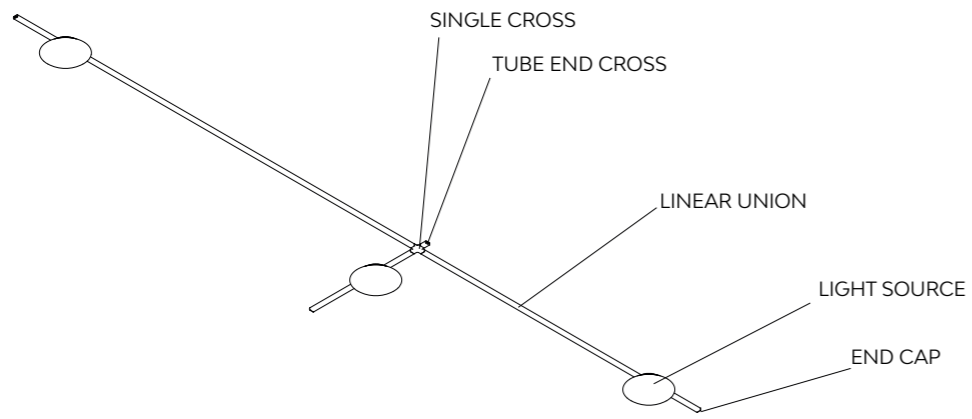

## CROSSHATCH SYSTEM INSTALLATION EXAMPLES

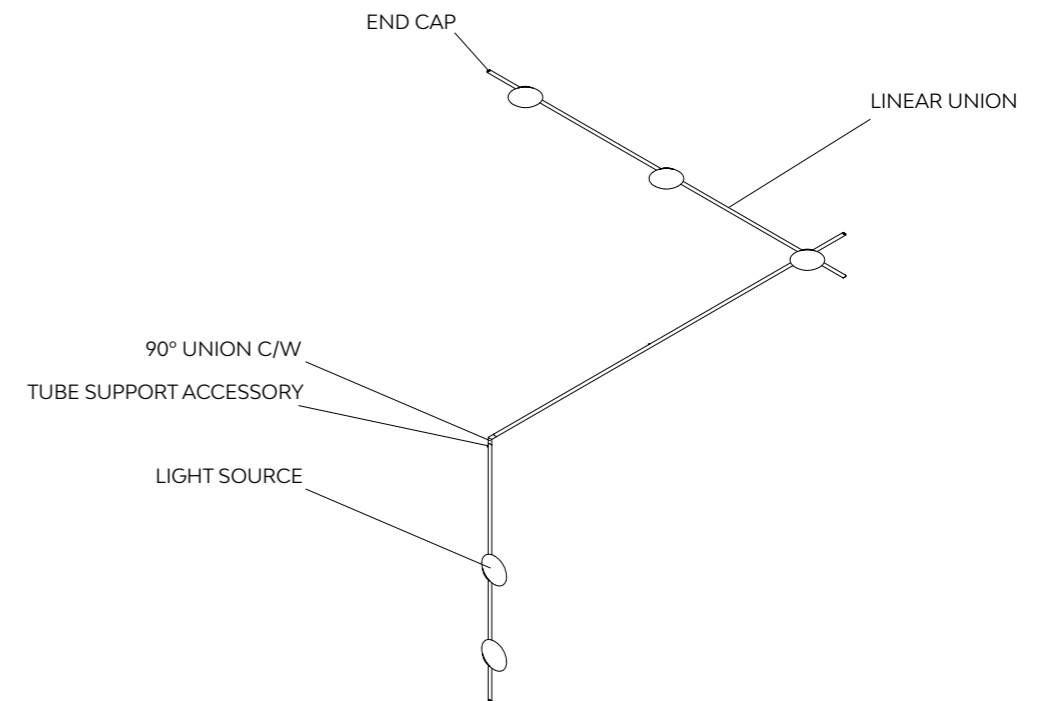
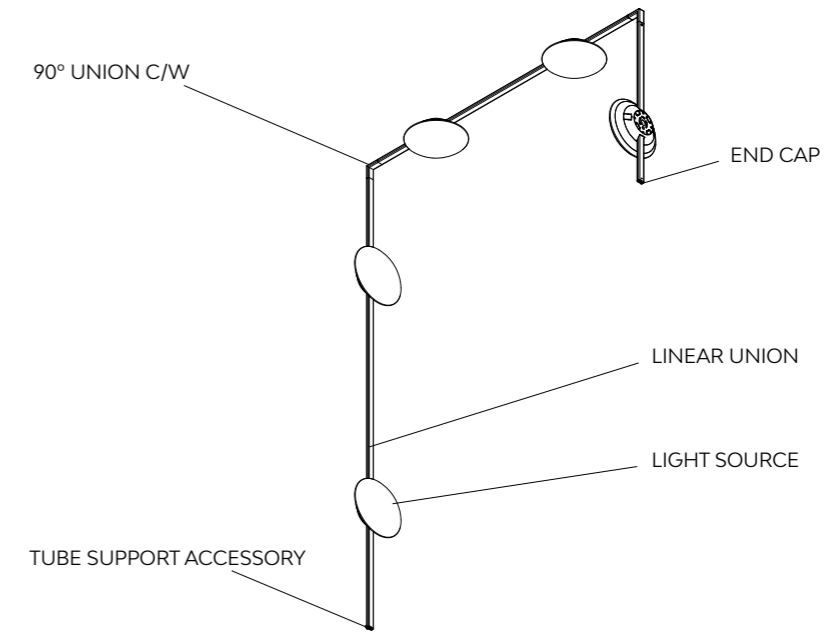



**B.lux**

# Kupetz

by  
E27 Tim Brauns

Decorative  
lighting

Lighting  
systems

3D light system made with different light sources and unions, and its arrangement allows you to adjust the lighting to each space. This is a metal tubular system in matte black where you can combine five types of light sources: a spotlight with an opal diffuser (Diffuser) and four glass spheres, two with an opal white finish and the other two with a smoked finish; both finishes are available in two sizes (100 Glass and 150 Glass). These spotlights and the base of the glass spheres come in three different finishes: black, copper and gold.

Sistema de iluminación tridimensional compuesto por diferentes fuentes de luz y uniones, cuya composición permite adecuar la iluminación a las necesidades de cada espacio. Se trata de un sistema tubular metálico en acabado negro mate, que permite combinar cinco tipos de fuente de luz: un proyector con difusor opal (Diffuser) y cuatro esferas de vidrio, dos de ellas en blanco opal y las otras dos en acabado ahumado, ambas disponibles en dos tamaños (100 Glass y 150 Glass). Estos proyectores y la base de las esferas de vidrio están disponibles en tres acabados: negro, cobre, y oro.

Dreidimensionales Leuchtsystem, bestehend aus verschiedenen Lichtquellen und Verbindungen, deren Komposition zulässt, die Beleuchtung an die Bedürfnisse jedes Raums anzupassen. Es handelt sich um ein Röhrensystem aus Metall in mattschwarzer Ausführung, in dem fünf Arten von Lichtquellen kombiniert werden können: ein Projektor mit opalfarbenem Diffusor (Diffuser) und vier Glaskugeln, zwei in opalweißer Ausführung und die anderen zwei in rauchiger Ausführung; beide Ausführungen sind in zwei Größen erhältlich (100 Glass und 150 Glass). Diese Projektoren und die Basis der Glaskugeln sind in drei Ausführungen verfügbar: Schwarz, Kupfer und Gold.



Kupetz



Decorative lighting Lighting systems

**KUPETZ 100 GLASS/SMOKE**

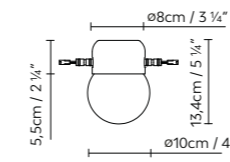

**KUPETZ 150 GLASS/SMOKE**

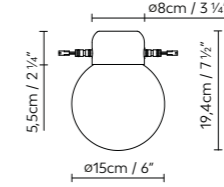

**KUPETZ DIFFUSER**

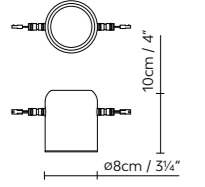

**KUPETZ T**

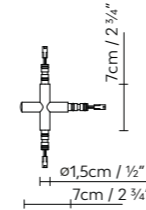

**KUPETZ T SH**

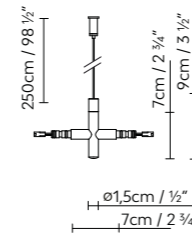

**KUPETZ T SV**

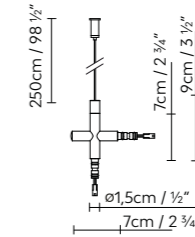

**KUPETZ T POWER SUPPLY**

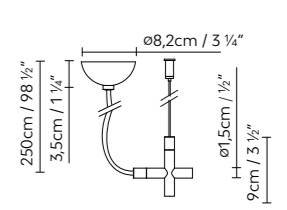

**KUPETZ X**

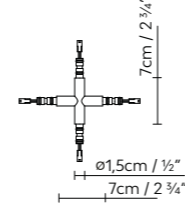

**KUPETZ XS**

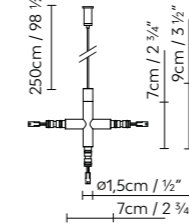

**KUPETZ XS POWER SUPPLY**

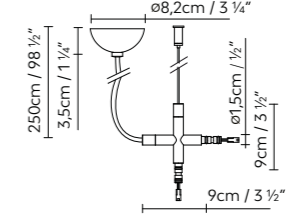

**KUPETZ XH POWER SUPPLY**

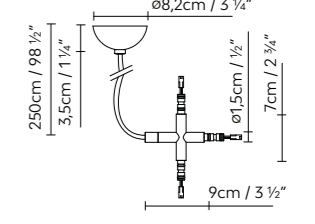

**KUPETZ S POWER SUPPLY**

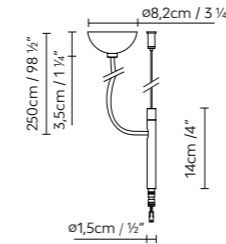

**KUPETZ SINGLE SUSPENSION**

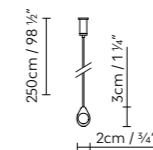

**KUPETZ LINEAR UNION**

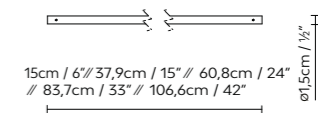

**KUPETZ EN CAP**

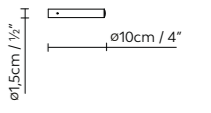

● Black (matte) ● Gold (satin) ● Copper (satin)

760300	<b>KUPETZ 100 GLASS</b> BLACK	LED 8W 560lm
760301	<b>KUPETZ 100 GLASS</b> GOLD	2700K CRI≥90 230V
760302	<b>KUPETZ 100 GLASS</b> COPPER	DIM PHASE CUT
760310	<b>KUPETZ 150 GLASS</b> BLACK	LED 8W 560lm
760311	<b>KUPETZ 150 GLASS</b> GOLD	2700K CRI≥90 230V
760312	<b>KUPETZ 150 GLASS</b> COPPER	DIM PHASE CUT
760303	<b>KUPETZ 100 SMOKE GLASS</b> BLACK	LED 8W 560lm
760304	<b>KUPETZ 100 SMOKE GLASS</b> GOLD	2700K CRI≥90 230V
760305	<b>KUPETZ 100 SMOKE GLASS</b> COPPER	DIM PHASE CUT
760313	<b>KUPETZ 150 SMOKE GLASS</b> BLACK	LED 8W 560lm
760314	<b>KUPETZ 150 SMOKE GLASS</b> GOLD	2700K CRI≥90 230V
760315	<b>KUPETZ 150 SMOKE GLASS</b> COPPER	DIM PHASE CUT
760330	<b>KUPETZ DIFFUSER</b> BLACK	LED 8W 560lm
760331	<b>KUPETZ DIFFUSER</b> GOLD	2700K CRI≥90 230V
760332	<b>KUPETZ DIFFUSER</b> COPPER	DIM PHASE CUT
760970	<b>KUPETZ END CAP</b>	

760911	<b>KUPETZ T</b>
760900	<b>KUPETZ T SH</b>
760910	<b>KUPETZ T SV</b>
760905	<b>KUPETZ T POWER SUPPLY</b>
760921	<b>KUPETZ X</b>
760920	<b>KUPETZ XS</b>
760925	<b>KUPETZ XS POWER SUPPLY</b>
760926	<b>KUPETZ XH POWER SUPPLY</b>
760980	<b>KUPETZ S POWER SUPPLY</b>
760915	<b>KUPETZ SINGLE SUSPENSION</b>
760950	<b>KUPETZ LINEAR UNION 15</b>
760951	<b>KUPETZ LINEAR UNION 40</b>
760952	<b>KUPETZ LINEAR UNION 60</b>
760953	<b>KUPETZ LINEAR UNION 85</b>
760954	<b>KUPETZ LINEAR UNION 105</b>

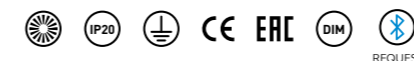



Kupetz



KUPETZ INSTALLATION EXAMPLES

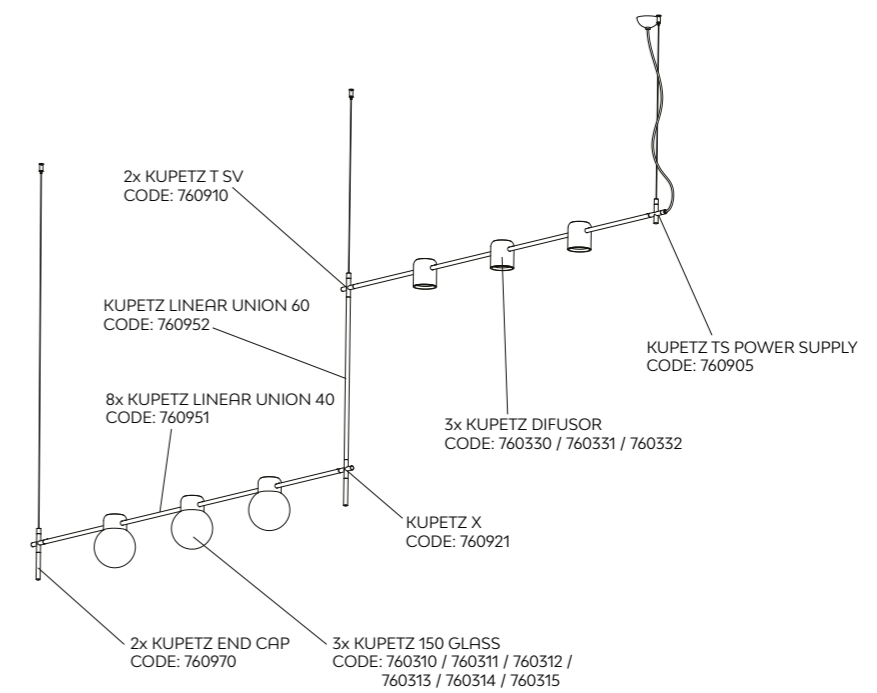

KUPETZ INSTALLATION EXAMPLES

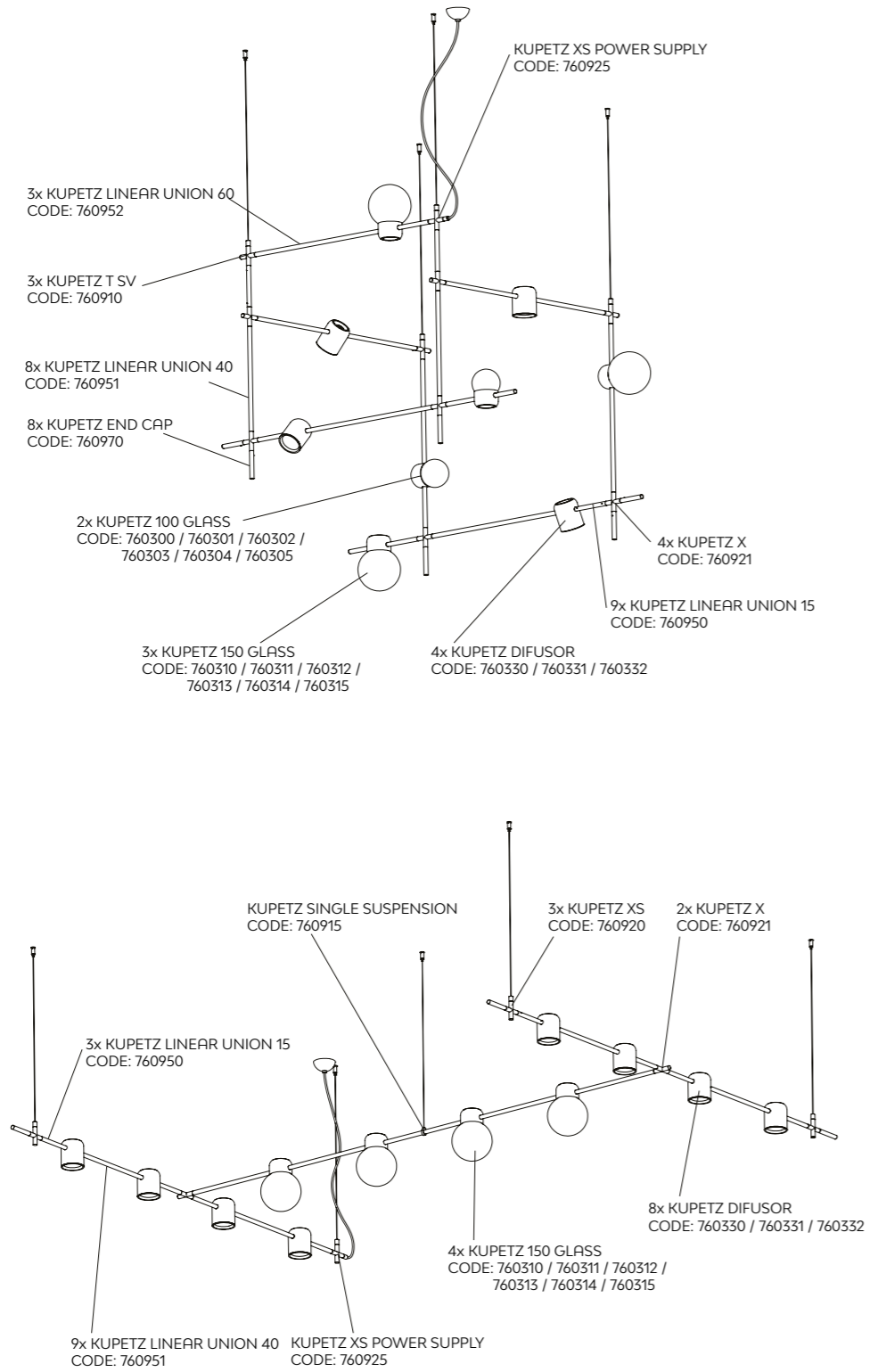

KUPETZ INSTALLATION EXAMPLES

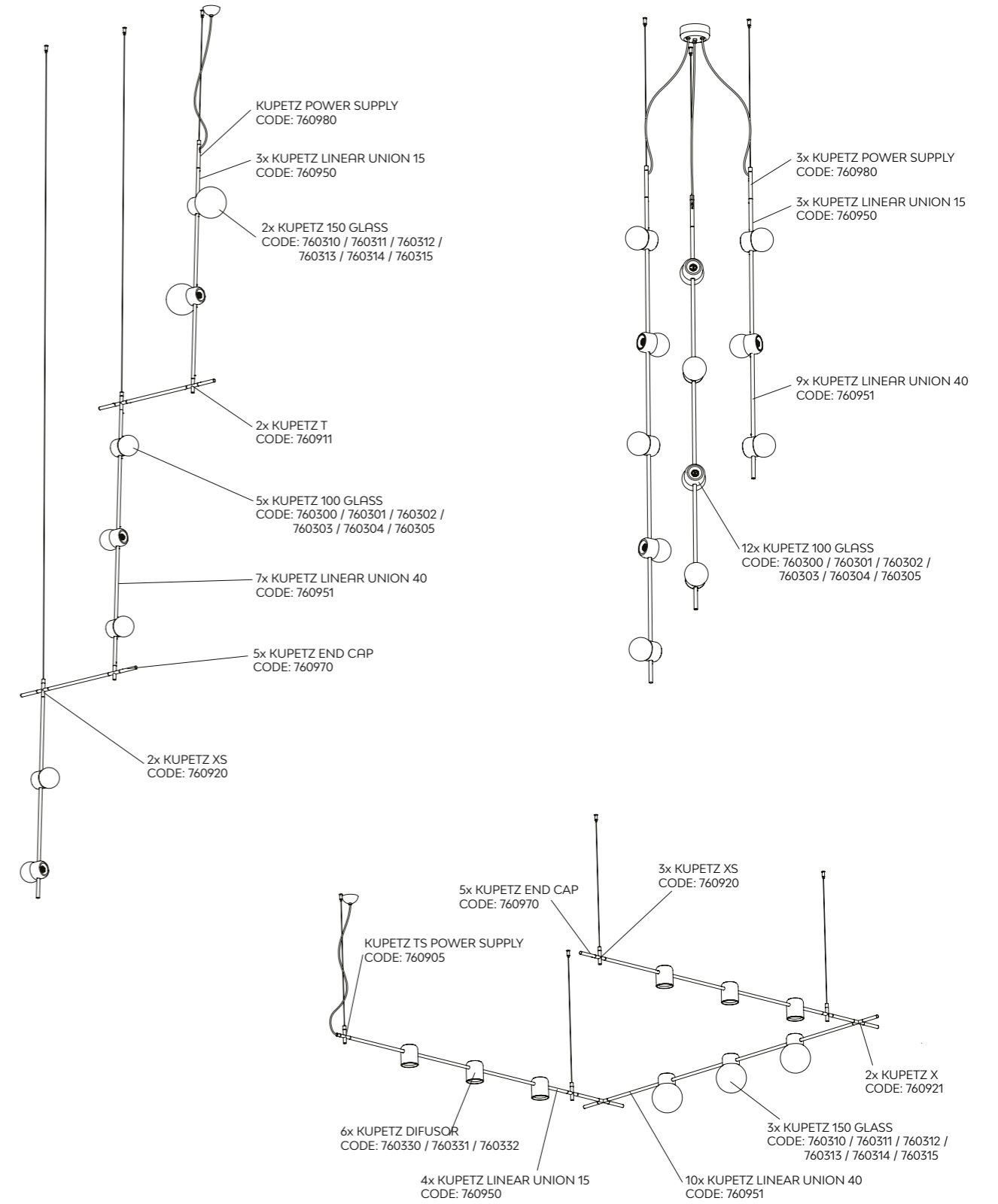



B.lux

# Architectural lighting





**B.lux**

# Anvil Spot S Shade Accessory

by  
David Abad

Architectural  
lighting

A collection of projectors made of aluminium, with direct lighting and LED bulbs. It is available in a wide range of RAL finishes.

Colección de proyectores fabricados en aluminio, de iluminación directa y lámparas LED. Está disponible en una amplia paleta de acabados RAL.

Richtstrahlersortiment aus Aluminium für direkte Beleuchtung und LED-Leuchten. Ist in einer Vielzahl von RAL-Farben erhältlich.



## ANVIL SPOT S SHADE ACCESSORY

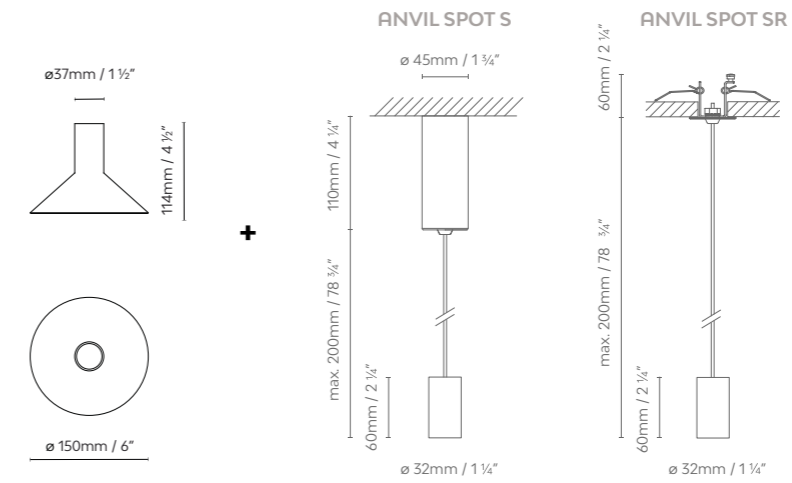

- |                           |                            |                            |                        |
|---------------------------|----------------------------|----------------------------|------------------------|
| Mustard (matte) RAL 1012  | Rose (matte) RAL 3015      | Forest (matte) RAL 6035    | Brown (matte) RAL 8025 |
| Lemon (matte) RAL 1018    | Red (matte) RAL 3020       | Khaki (matte) RAL 7008     | Snow (matte) RAL 9003  |
| Mango (matte) RAL 1034    | Aqua (matte) RAL 5024      | Silex (matte) RAL 7032     | Terracotta (matte)     |
| Pearl (matte) RAL 1035    | River (matte) RAL 5017     | Concret (matte) RAL 7033   | Black (matte)          |
| Orange (matte) RAL 2013   | Horizon (matte) RAL 5023   | Limestone (matte) RAL 7035 | White (matte)          |
| Burgundy (matte) RAL 3011 | Turquoise (matte) RAL 6034 | Grey (matte) RAL 7037      | Brass (matte)          |

851795U ANVIL SPOT S SHADE ACCESSORY BRASS  
 851796U ANVIL SPOT S SHADE ACCESSORY WHITE  
 851797U ANVIL SPOT S SHADE ACCESSORY BLACK  
 851794+CU ANVIL SPOT S SHADE ACCESSORY+



Check out your colour at  
[www.bluxlighting.com](http://www.bluxlighting.com)





**B.lux**

# BIMU

by  
Carrasquet

Architectural  
lighting

BIMU is a simple three-dimensional linear lighting system based on linear components measuring 1000, 1500 and 2000 mm in length and 20 mm in diameter. The linear components are interlinked via a system of fast-connection jacks that allows the light source to be freely rotated on its axis. In addition, the system allows the luminaire to be installed in a stepped format at different heights and angles (its small ears mean the angles are absorbed very naturally). Finishes: Matte black, matte white and black orange.

BIMU es un sencillo sistema de iluminación lineal tridimensional basado en elementos lineales de 1000, 1500 y 2000mm de longitud y 20 mm de diámetro. Los elementos lineales se enlazan a través de un sistema de jacks de conexión rápida que permiten girar libremente la fuente de luz sobre su eje. Además, el sistema permite instalar la luminaria de forma escalonada a diferentes alturas y ángulos (sus pequeñas orejas hacen que los ángulos se absorban de forma muy natural). Acabados: Negro mate, blanco mate y negro naranja.

BIMU ist ein einfaches dreidimensionales lineares Beleuchtungssystem bestehend aus linearen Elementen von 1000, 1500 und 2000 mm Länge und 20 mm Durchmesser. Die linearen Elemente sind durch ein System von Schnellkupplungen verbunden, die eine freie Drehung der Lichtquelle um ihre Achse ermöglichen. Darüber hinaus ermöglicht das System eine gestaffelte Installation der Leuchte in verschiedenen Höhen und Winkeln (die kleinen Ohren ermöglichen eine sehr natürliche Aufnahme der Winkel). Ausführungen: Mattschwarz, Mattweiß und Orange-Schwarz.



BIMU

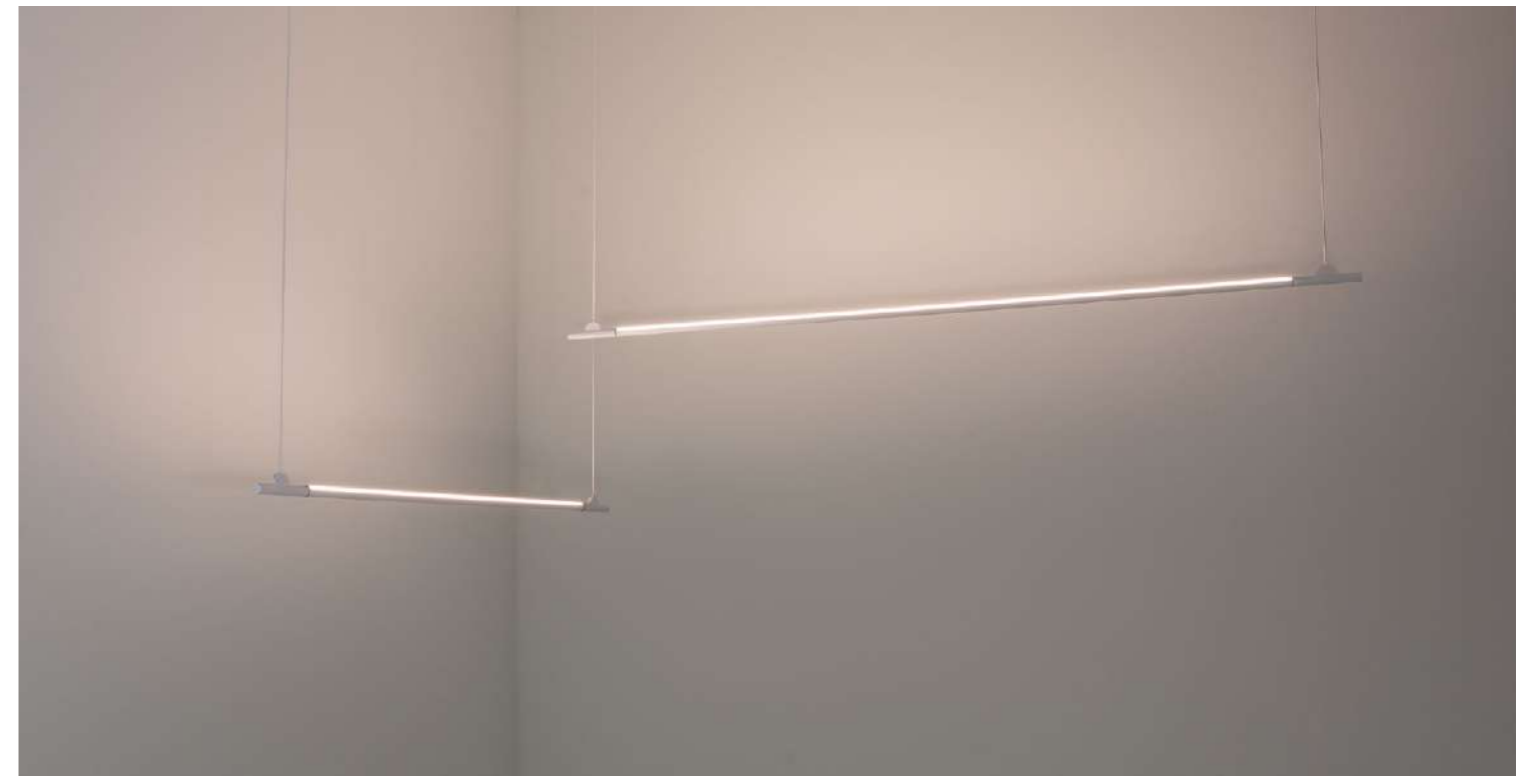
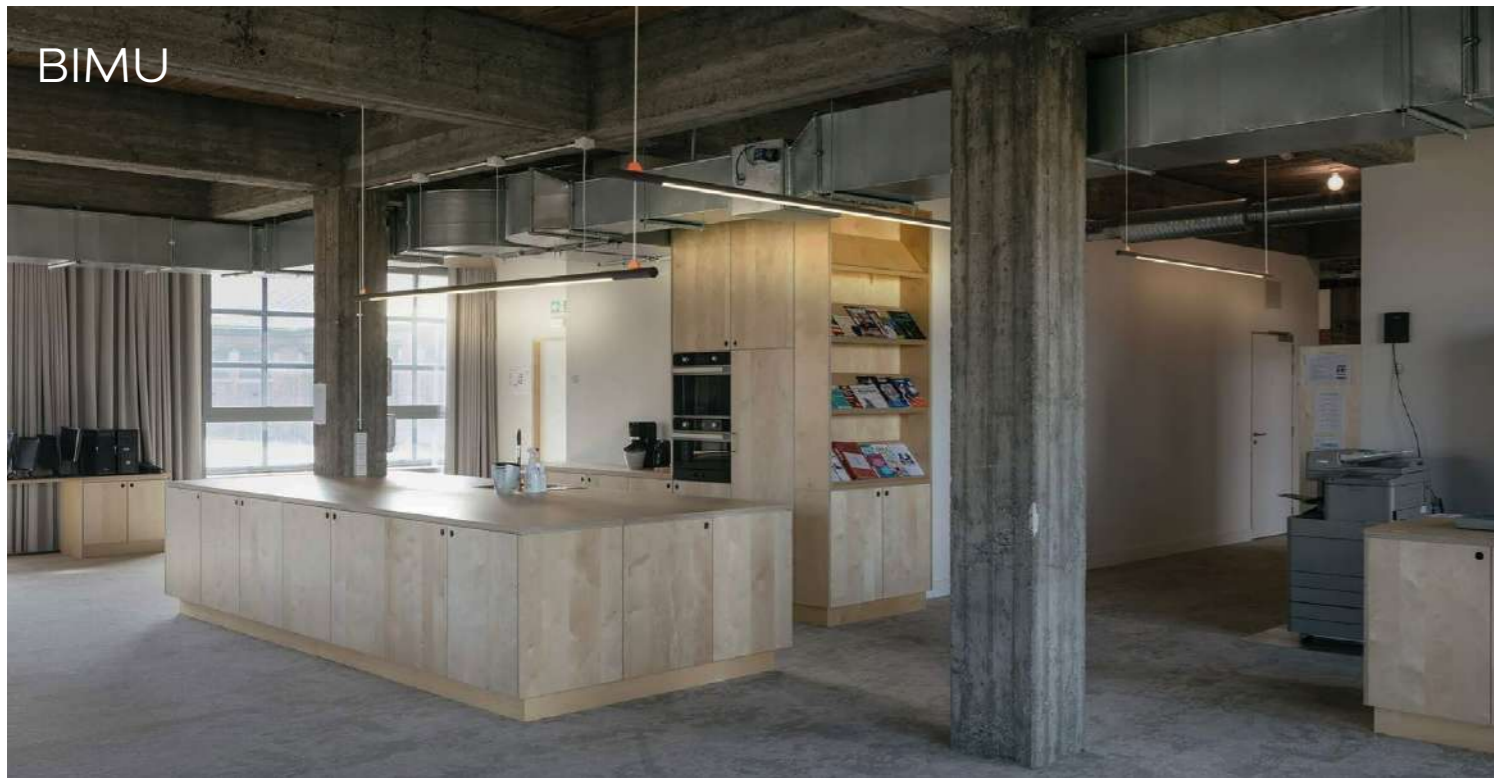

**BIMU S UNI**

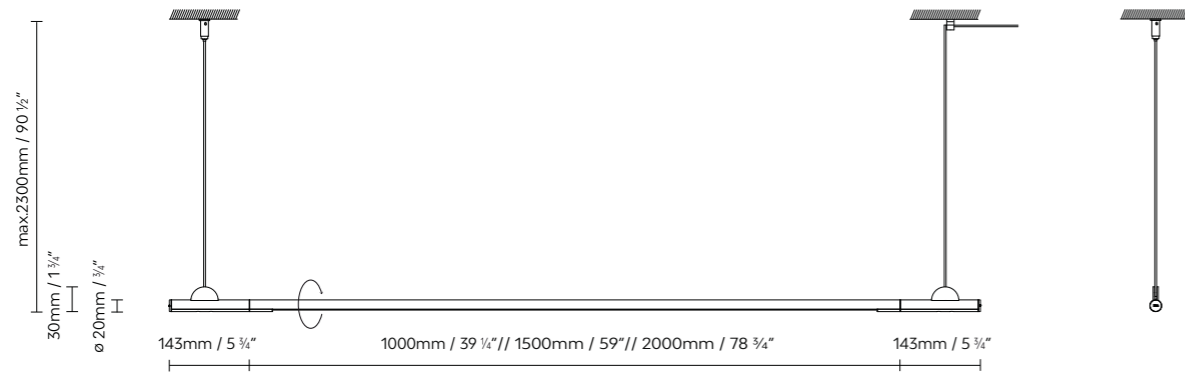

- Black (matte)
- Black-Orange (matte)
- White (matte)

773100	<b>BIMU S100 UNI</b> BLACK	
773101	<b>BIMU S100 UNI</b> BLACK ORANGE	LED 15W 1679lm 24V 2700K CRI≥90
773102	<b>BIMU S100 UNI</b> WHITE	
773110	<b>BIMU S150 UNI</b> BLACK	
773111	<b>BIMU S150 UNI</b> BLACK ORANGE	LED 22,5W 2518.5lm 24V 2700K CRI≥90
773112	<b>BIMU S150 UNI</b> WHITE	
773120	<b>BIMU S200 UNI</b> BLACK	
773121	<b>BIMU S200 UNI</b> BLACK ORANGE	LED 30W 3358lm 24V 2700K CRI≥90
773122	<b>BIMU S200 UNI</b> WHITE	

**BIMU S DEP**

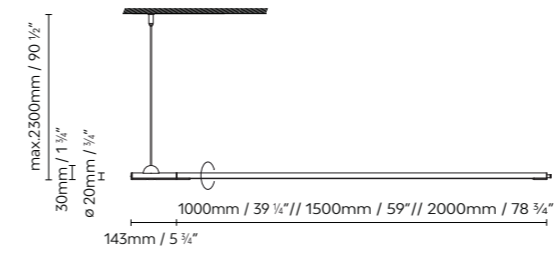

**BIMU S ELE**

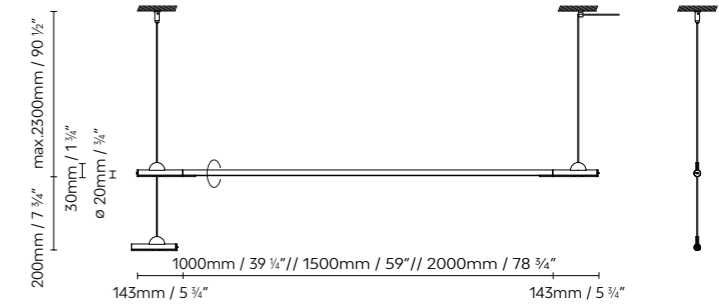

773200	<b>BIMU S100 DEP</b> BLACK	
773201	<b>BIMU S100 DEP</b> BLACK ORANGE	LED 15W 1679lm 24V 2700K CRI≥90
773202	<b>BIMU S100 DEP</b> WHITE	
773210	<b>BIMU S150 DEP</b> BLACK	
773211	<b>BIMU S150 DEP</b> BLACK ORANGE	LED 22,5W 2518.5lm 24V 2700K CRI≥90
773212	<b>BIMU S150 DEP</b> WHITE	
773220	<b>BIMU S200 DEP</b> BLACK	
773221	<b>BIMU S200 DEP</b> BLACK ORANGE	LED 30W 3358lm 24V 2700K CRI≥90
773222	<b>BIMU S200 DEP</b> WHITE	

773300	<b>BIMU S100 ELE</b> BLACK	
773301	<b>BIMU S100 ELE</b> BLACK ORANGE	LED 15W 1679lm 24V 2700K CRI≥90
773302	<b>BIMU S100 ELE</b> WHITE	
773310	<b>BIMU S150 ELE</b> BLACK	
773311	<b>BIMU S150 ELE</b> BLACK ORANGE	LED 22,5W 2518.5lm 24V 2700K CRI≥90
773312	<b>BIMU S150 ELE</b> WHITE	
773320	<b>BIMU S200 ELE</b> BLACK	
773321	<b>BIMU S200 ELE</b> BLACK ORANGE	LED 30W 3358lm 24V 2700K CRI≥90
773322	<b>BIMU S200 ELE</b> WHITE	

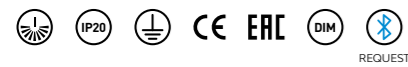

REQUEST

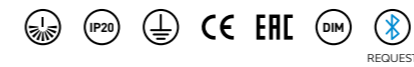

REQUEST



# BIMU



## BIMU SINGLE CANOPY

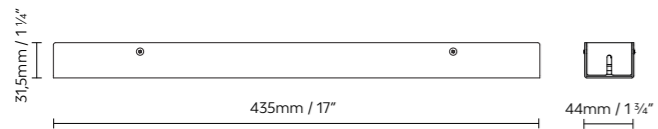

## BIMU INDIVUAL HOOK

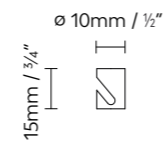

## BIMU MULTIPLE CANOPY

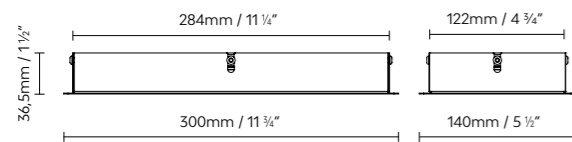

## BIMU DOUBLE HOOK

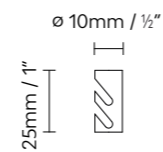

## INSTALLATION EXAMPLES

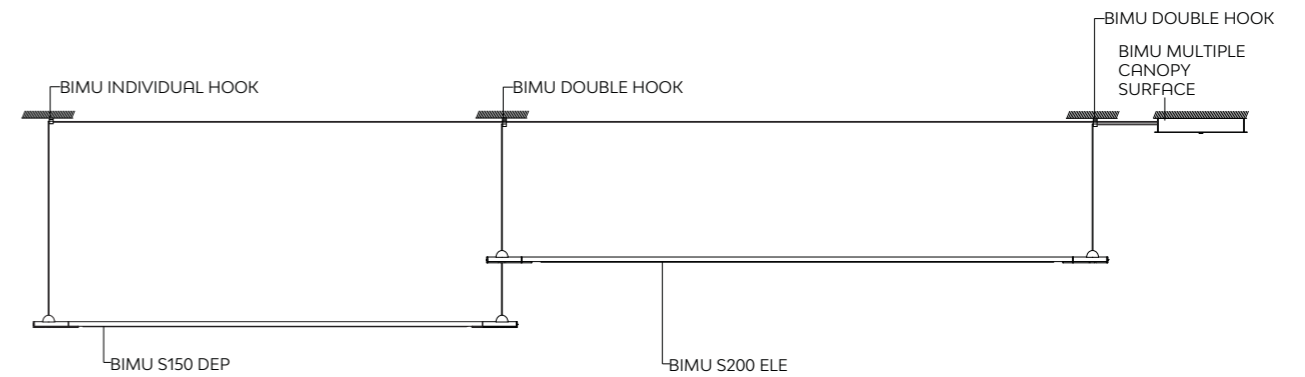
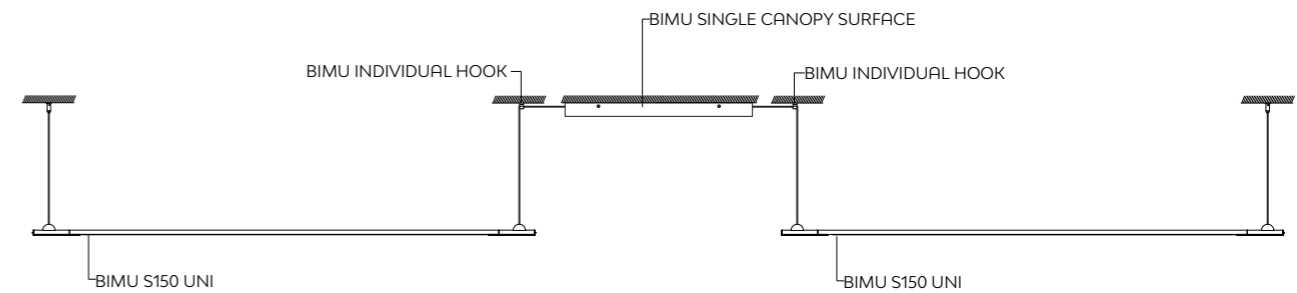

773900	<b>BIMU SINGLE CANOPY SURFACE BLACK</b>	24V DC 60W 230V
773900D	<b>BIMU SINGLE CANOPY SURFACE BLACK DIM</b>	24V DC 70W 230V PUSH/DALI/1-10V
773902	<b>BIMU SINGLE CANOPY SURFACE WHITE</b>	24V DC 60W 230V
773902D	<b>BIMU SINGLE CANOPY SURFACE WHITE DIM</b>	24V DC 70W 230V PUSH/DALI/1-10V
773950	<b>BIMU MULTIPLE CANOPY SURFACE BLACK</b>	24V DC 200W 230V
773950D	<b>BIMU MULTIPLE CANOPY SURFACE BLACK DIM</b>	24V DC 200W 230V PUSH/DALI/1-10V
773952	<b>BIMU MULTIPLE CANOPY SURFACE WHITE</b>	24V DC 200W 230V
773952D	<b>BIMU MULTIPLE CANOPY SURFACE WHITE DIM</b>	24V DC 200W 230V PUSH/DALI/1-10V

773980	<b>BIMU INDIVUAL HOOK</b>
773990	<b>BIMU DOUBLE HOOK</b>





INSTALLATION EXAMPLES

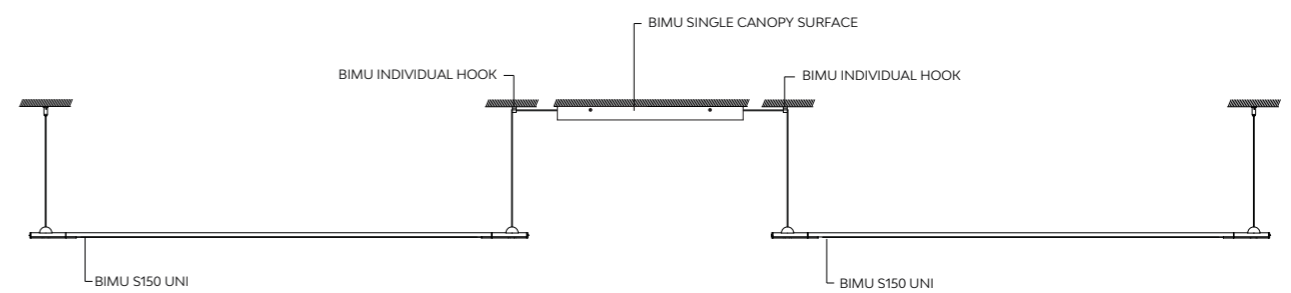
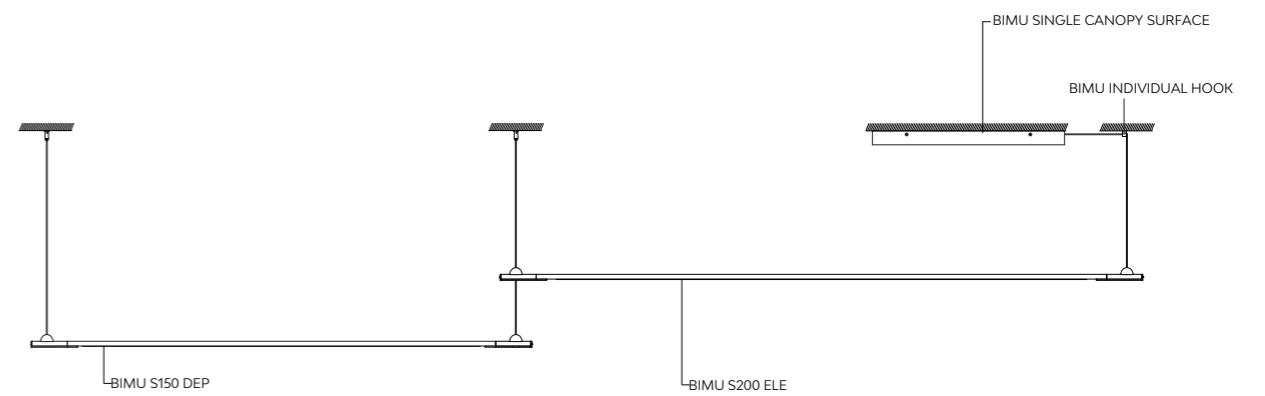



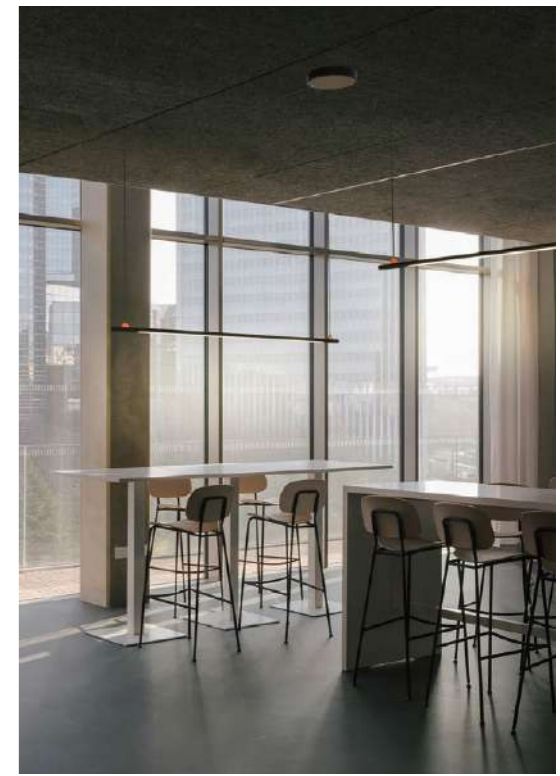

INSTALLATION EXAMPLES

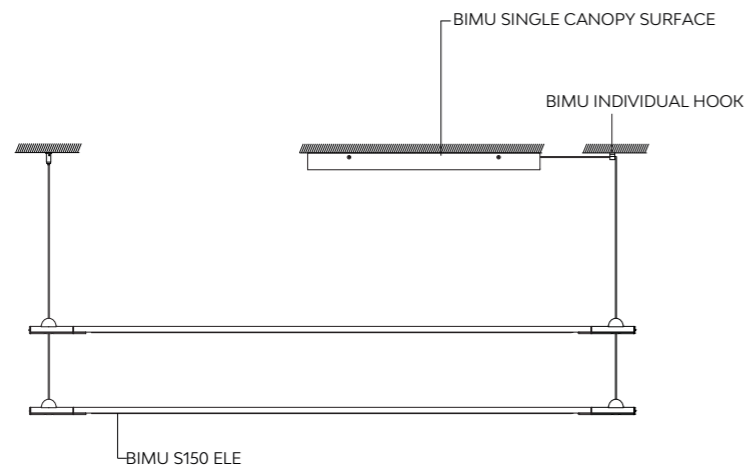

INSTALLATION EXAMPLES

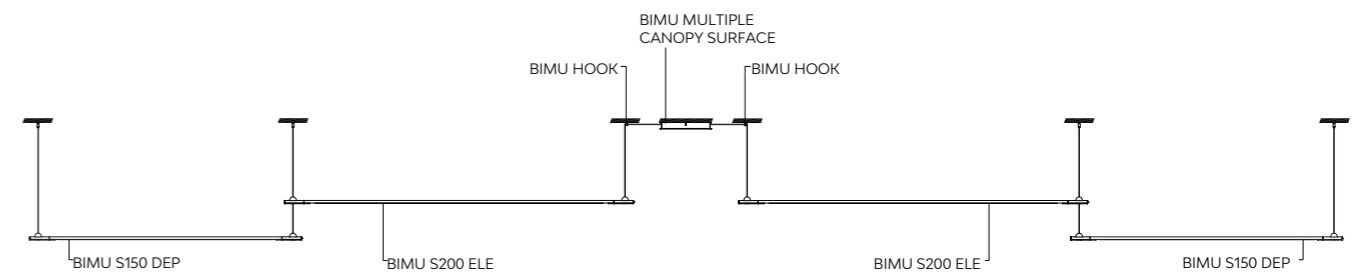
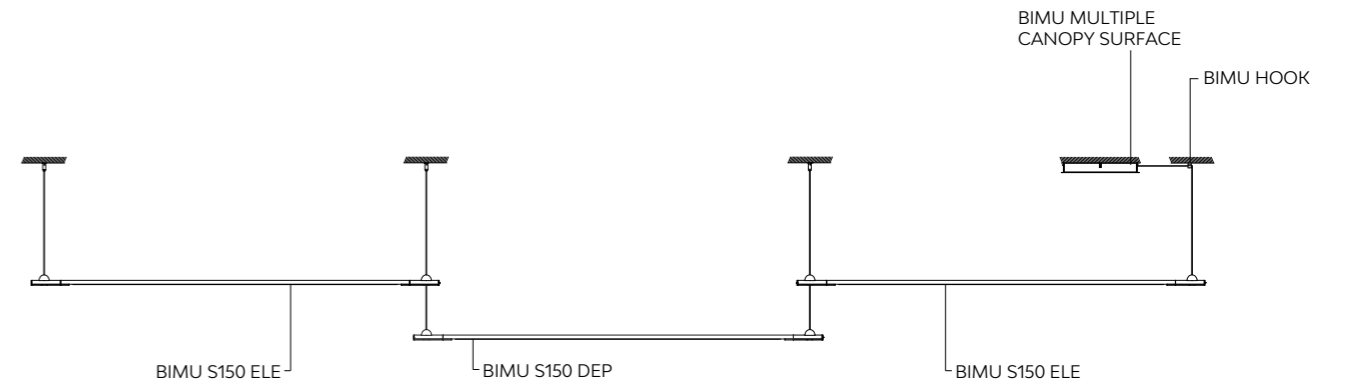

**B.lux**

# BIMU SV

by  
**Carrasquet**

**Architectural  
lighting**

BIMU SV is a linear suspended luminaire, adjustable in height from floor to ceiling via a simple cable system on which it slides. The ceiling attachment includes a metal retainer, while the base on the floor rests by gravity on this retainer.

The luminaire allows for the installation of its canopy for power supply from the ceiling or floor. Small tabs ensure that the power and mechanical cables enter the profile very naturally. Finishes: Matte black, matte white and matte black-orange.

BIMU SV es una luminaria lineal de suspensión suelo-techo regulable en altura a través de un sencillo sistema de cable sobre el que se desliza la luminaria. La fijación a techo cuenta con un retenedor metálico y la base a suelo simplemente se apoya por gravedad sobre este.

La luminaria permite instalar su florón para alimentar desde techo o desde suelo. Las pequeñas orejas hacen que las entradas de cable de corriente y cable mecánico entren al perfil de forma muy natural. Acabados: Negro mate, blanco mate y negro naranja.

BIMU SV ist eine lineare Boden-Decken-Pendelleuchte mit einem einfachen Kabelsystem, an dem die Leuchte nach oben oder unten geschoben werden kann. An der Decke ist sie mit einer Metallhalterung befestigt und die Basis steht einfach schwerkraftbedingt auf dem Boden.

Der Fleuron zur Stromversorgung der Leuchte kann an der Decke oder am Boden installiert werden. Die kleinen Ohröffnungen ermöglichen eine natürliche Einführung der Stromleitung und des mechanischen Kabels in das Profil. Ausführungen: Mattschwarz, Mattweiß und Orange-Schwarz.







**BIMU SV**

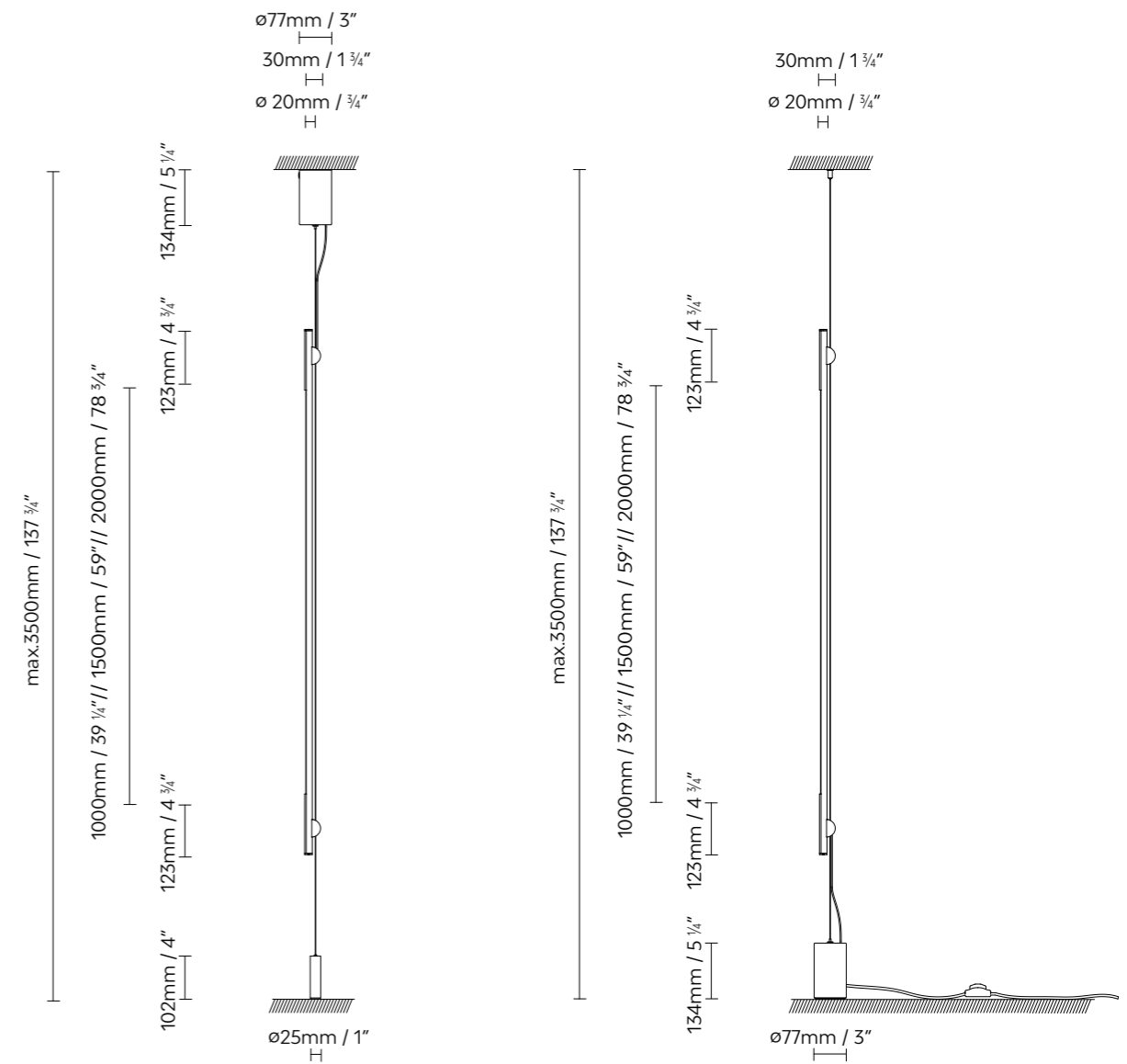

- Black (matte)
- Black-Orange (matte)
- White (matte)

773600	<b>BIMU SV100 BLACK</b>	
773601	<b>BIMU SV100 BLACK ORANGE</b>	LED 15W 1679lm 2700K CRI≥90 230V
773602	<b>BIMU SV100 WHITE</b>	
773610	<b>BIMU SV150 BLACK</b>	
773611	<b>BIMU SV150 BLACK ORANGE</b>	LED 22,5W 2518.5lm 2700K CRI≥90 230V
773612	<b>BIMU SV150 WHITE</b>	
773960	<b>BIMU SV PLUG-IN ACCESSORY</b>	



**B.lux**

# Blokinline

## Architectural lighting

Blokinline is an architectural lighting system based on an electrified, compact track (dimmable to 48 V). It enables individual components with high luminous flux to be incorporated and positioned freely along the track's length. The system is available in both a surface version and a pendant version, with the track always in a black finish.

The Blokinline light sources are comprised of opal glass spheres (100/150 mm), projectors, multiple direct light modules with 2 or 4 spotlights and reflectors with varying angles of aperture (38°/60°) and attached, suspended or pivotable linear lighting components. Light sources are available in brass, black and white finishes.

The mobile track system enables the creation of endless diverse compositions, and angles of 90° and 180° either horizontally or vertically, can also be added. It also has angles with radii of 300 or 500 mm available, enabling curved forms to be created.

Blokinline es un sistema de iluminación arquitectural basado en un carril electrificado de tamaño compacto, regulable a 48V. Permite incorporar elementos individuales de alto flujo lumínico que pueden posicionarse de forma libre a lo largo del carril. El sistema está disponible tanto en versión superficie como en suspensión, con el carril siempre en acabado negro.

Las fuentes de luz de Blokinline se componen de esferas de vidrio opal (100/150 mm), proyectores, módulos múltiples de luz directa de 2 y 4 spots con reflectores de diferentes ángulos de apertura (38°/60°) y elementos de luz lineal adosados, suspendidos u orientables. Las fuentes de luz están disponibles en los acabados latón, negro y blanco.

El sistema de carriles móviles posibilita realizar composiciones variadas e infinitas, añadiendo incluso ángulos de 90° y 180° en horizontal o vertical. A su vez, dispone de ángulos con radios de 300 o 500 mm que permiten crear formas curvas.

Blokinline ist ein architektonisches Beleuchtungssystem auf einer kompakten, dimmbaren 48-V-Stromschiene. Es erlaubt die Integration einzelner Elemente mit hoher Lichtintensität, die entlang der Schiene frei positioniert werden können. Das System ist sowohl als Aufputz- als auch Pendelversion erhältlich, wobei die Schiene immer in schwarzer Farbe ausgeführt ist.

Die Lichtquellen von Blokinline umfassen Opalglasskugeln (100/150 mm), Strahler, Direktlichtmodule mit 2 und 4 Lichtpunkten und Reflektoren unterschiedlicher Öffnungswinkel (38°/60°) sowie steckbare, hängende oder ausrichtbare lineare Lichtelemente. Die Lichtquellen sind in den Ausführungen Messing, Schwarz und Weiß erhältlich.

Das bewegliche Schienensystem ermöglicht verschiedenartige Kompositionen, Endlossysteme und sogar die Installation mit horizontalen oder vertikalen 90°- und 180°-Winkeln. Dank der Winkelradien von 300 oder 500 mm können auch gebogene Formen kreiert werden.







**BLOKINLINE SYSTEM CANOPY**

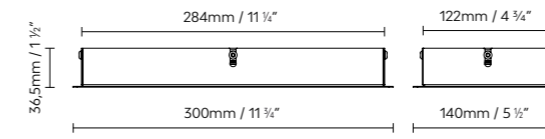

**BLOKINLINE SYSTEM CANOPY SR**

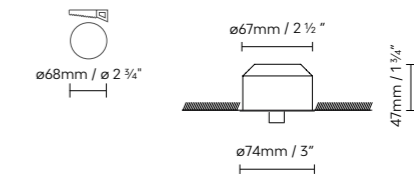

**BLOKINLINE SYSTEM DRIVER ON TRACK**

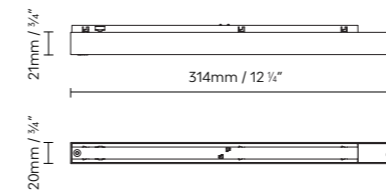

**BLOKINLINE SYSTEM SIMPLE CANOPY ACCESSORY**

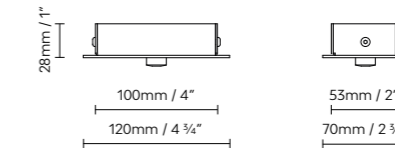

**BLOKINLINE SYSTEM POWER SUPPLY**

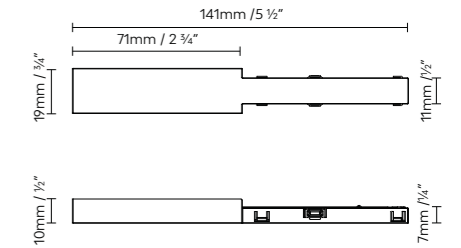

**BLOKINLINE SYSTEM PROFILE**

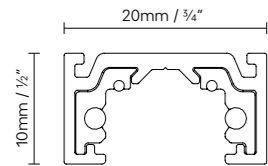

**BLOKINLINE SYSTEM PROFILE R300-R500**

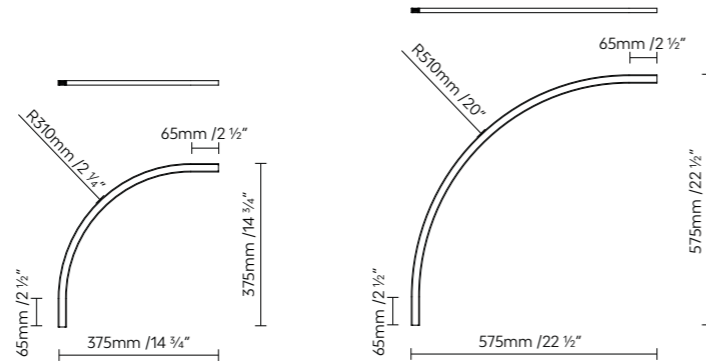

**BLOKINLINE SYSTEM 90° H UNION**

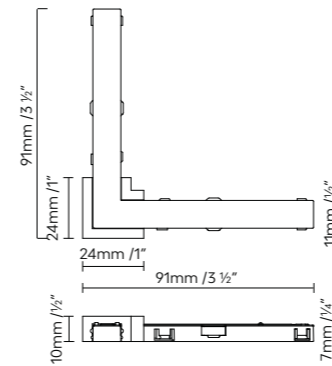

**BLOKINLINE SYSTEM 90° V UNION**

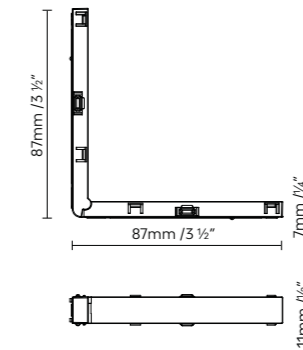

**BLOKINLINE SYSTEM 180° UNION**

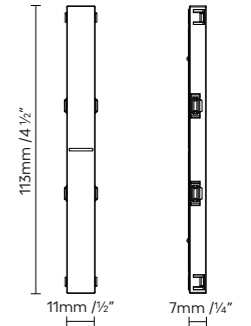

**BLOKINLINE SYSTEM SINGLE SUSPENSION**



**BLOKINLINE SYSTEM END CAP**

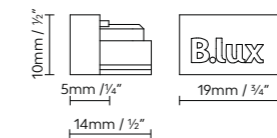

**BLOKINLINE SYSTEM HOOK**

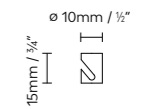

● Black (matte)

768930	<b>BLOKINLINE SYSTEM POWER SUPPLY</b>	
768910	<b>BLOKINLINE SYSTEM SURFACE/SUSPENSION PROFILE BLACK (1M)</b>	
768911	<b>BLOKINLINE SYSTEM SURFACE/SUSPENSION PROFILE BLACK (2M)</b>	
768910C	<b>BLOKINLINE SYSTEM SURFACE/SUSPENSION PROFILE R300 BLACK</b>	
768911C	<b>BLOKINLINE SYSTEM SURFACE/SUSPENSION PROFILE R500 BLACK</b>	
768996	<b>BLOKINLINE SYSTEM DRIVER ON TRACK 48V 100W DIM PUSH/DALI</b>	
768998	<b>BLOKINLINE SYSTEM CANOPY/DRIVER 48V 100W ON-OFF</b>	CANOPY DRIVER (SURFACE CANOPY)
768998D	<b>BLOKINLINE SYSTEM CANOPY/DRIVER 48V 100W DIM</b>	CANOPY DRIVER (SURFACE CANOPY)
768994	<b>BLOKINLINE SYSTEM CANOPY SR / DRIVER 48V 100W ON-OFF</b>	CANOPY DRIVER (SEMI-RECESSED CANOPY)
768995	<b>BLOKINLINE SYSTEM CANOPY SR / DRIVER 48V 100W DIM</b>	CANOPY DRIVER (SEMI-RECESSED CANOPY)
768999	<b>BLOKINLINE SYSTEM DRIVER 48V 100W ON-OFF</b>	
768999D	<b>BLOKINLINE SYSTEM DRIVER 48V 100W DIM</b>	
768997	<b>BLOKINLINE WIRE HOOK</b>	

● Black (matte)

768960	<b>BLOKINLINE SYSTEM 90° H UNION</b>
768970	<b>BLOKINLINE SYSTEM 90° V UNION</b>

768980	<b>BLOKINLINE SYSTEM 180° UNION</b>
--------	-------------------------------------

768940	<b>BLOKINLINE END CAP</b>
--------	---------------------------

768990	<b>BLOKINLINE SINGLE SUSPENSION</b>
--------	-------------------------------------

Blokinline



**LIGHT SOURCES**

**BLOKINLINE SYSTEM MODULE 2**

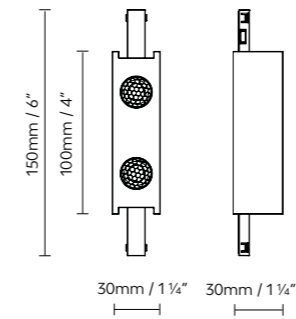

**BLOKINLINE SYSTEM MODULE 4**

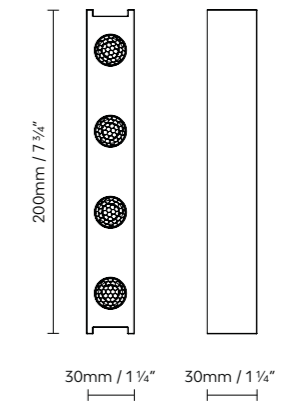

- Black (matte)
- Brass (matte)
- White (matte)

<p>768500 768501 768502 768510 768511 768512</p>	<p><b>BLOKINLINE SYSTEM MODULE 2 38° BLACK</b>  <b>BLOKINLINE SYSTEM MODULE 2 38° WHITE</b>  <b>BLOKINLINE SYSTEM MODULE 2 38° BRASS</b>  <b>BLOKINLINE SYSTEM MODULE 2 60° BLACK</b>  <b>BLOKINLINE SYSTEM MODULE 2 60° WHITE</b>  <b>BLOKINLINE SYSTEM MODULE 2 60° BRASS</b></p>	<p>LED 2 x 3W 790lm 2700K CRI≥90 48V</p> <p style="text-align: right;">* 3000K and 4000K available under request</p>
<p>768600 768601 768602 768610 768611 768612</p>	<p><b>BLOKINLINE SYSTEM MODULE 4 38° BLACK</b>  <b>BLOKINLINE SYSTEM MODULE 4 38° WHITE</b>  <b>BLOKINLINE SYSTEM MODULE 4 38° BRASS</b>  <b>BLOKINLINE SYSTEM MODULE 4 60° BLACK</b>  <b>BLOKINLINE SYSTEM MODULE 4 60° WHITE</b>  <b>BLOKINLINE SYSTEM MODULE 4 60° BRASS</b></p>	<p>LED 4 x 3W 1580lm 2700K CRI≥90 48V</p> <p style="text-align: right;">* 3000K and 4000K available under request</p>



# Blokinline



## LIGHT SOURCES

### BLOKINLINE SYSTEM SPOT C

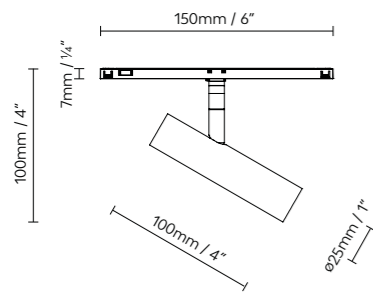

### BLOKINLINE SYSTEM SPOT S

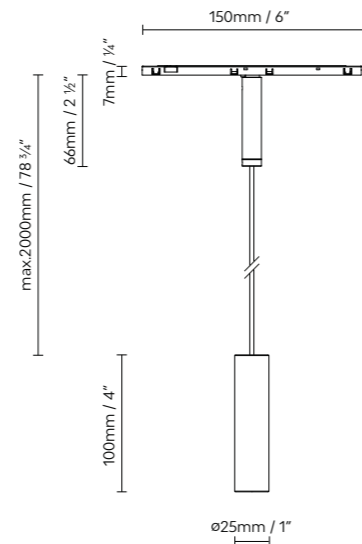

- Black (matte)
- Brass (matte)
- White (matte)

768300	<b>BLOKINLINE SYSTEM SPOT S 38°</b> BLACK	LED 3W 395lm 250mA 2700K CRI≥90 48V * 3000K and 4000K available under request
768301	<b>BLOKINLINE SYSTEM SPOT S 38°</b> WHITE	
768302	<b>BLOKINLINE SYSTEM SPOT S 38°</b> BRASS	
768310	<b>BLOKINLINE SYSTEM SPOT S 60°</b> BLACK	
768311	<b>BLOKINLINE SYSTEM SPOT S 60°</b> WHITE	
768312	<b>BLOKINLINE SYSTEM SPOT S 60°</b> BRASS	
768400	<b>BLOKINLINE SYSTEM SPOT C 38°</b> BLACK	LED 3W 395lm 250mA 2700K CRI≥90 48V * 3000K and 4000K available under request
768401	<b>BLOKINLINE SYSTEM SPOT C 38°</b> WHITE	
768402	<b>BLOKINLINE SYSTEM SPOT C 38°</b> BRASS	
768410	<b>BLOKINLINE SYSTEM SPOT C 60°</b> BLACK	
768411	<b>BLOKINLINE SYSTEM SPOT C 60°</b> WHITE	
768412	<b>BLOKINLINE SYSTEM SPOT C 60°</b> BRASS	

## LIGHT SOURCES

### BLOKINLINE SYSTEM SPHERE S100/S150

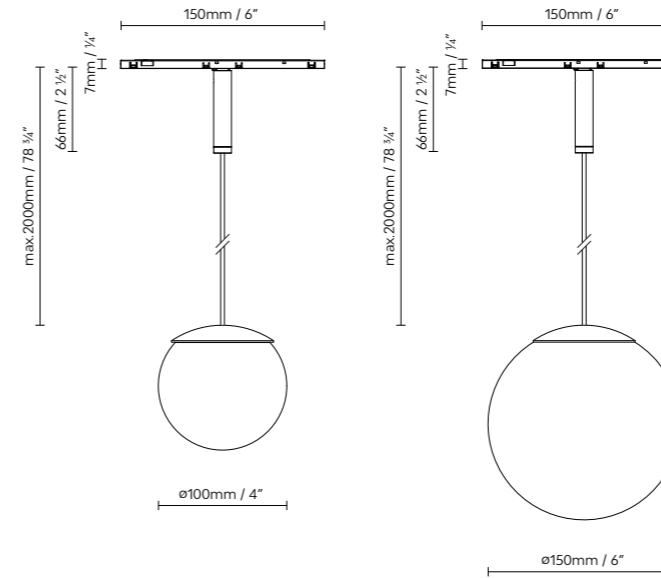

### BLOKINLINE SYSTEM SPHERE C100/C150

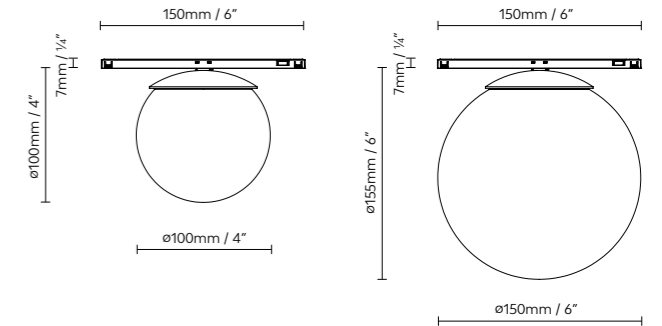

- Opal Glass
- Smoke Glass

768110	<b>BLOKINLINE SYSTEM SPHERE S100</b> OPAL BLACK	LED 3W 395lm 250mA 2700K CRI≥90 48V * 3000K and 4000K available under request
768111	<b>BLOKINLINE SYSTEM SPHERE S100</b> OPAL WHITE	
768150	<b>BLOKINLINE SYSTEM SPHERE S150</b> OPAL BLACK	
768151	<b>BLOKINLINE SYSTEM SPHERE S150</b> OPAL WHITE	
768153	<b>BLOKINLINE SYSTEM SPHERE S150</b> SMOKE	
768210	<b>BLOKINLINE SYSTEM SPHERE C100</b> OPAL BLACK	
768211	<b>BLOKINLINE SYSTEM SPHERE C100</b> OPAL WHITE	LED 3W 395lm 250mA 2700K CRI≥90 48V * 3000K and 4000K available under request
768250	<b>BLOKINLINE SYSTEM SPHERE C150</b> OPAL BLACK	
768251	<b>BLOKINLINE SYSTEM SPHERE C150</b> OPAL WHITE	
768253	<b>BLOKINLINE SYSTEM SPHERE C150</b> SMOKE	

Blokinline



**BLOKINLINE SYSTEM LEDLINE 400**

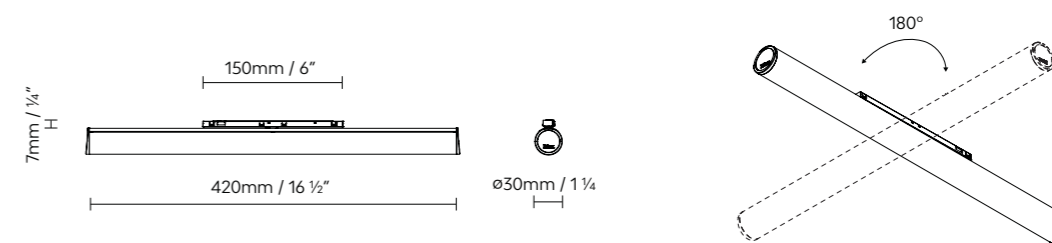

- Black (matte)   ● Brass (matte)   ○ White (matte)

768700	<b>BLOKINLINE SYSTEM LEDLINE 400 BLACK</b>	LED 9W 1466lm 2700K CRI≥90 48V
768701	<b>BLOKINLINE SYSTEM LEDLINE 400 WHITE</b>	
768702	<b>BLOKINLINE SYSTEM LEDLINE 400 BRASS</b>	



# Blokinline



## BLOKINLINE LEDLINE 900

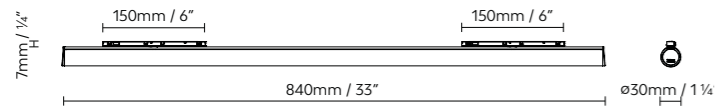

## BLOKINLINE LEDLINE 1200

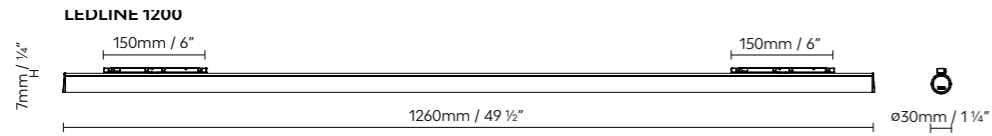

## BLOKINLINE LEDLINE 1800

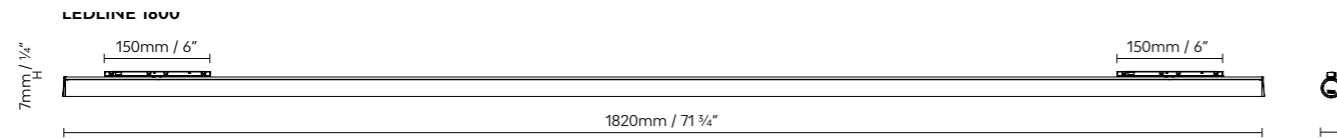

● Black (matte) ● Brass (matte) ○ White (matte)

768710	<b>BLOKINLINE LEDLINE 900</b> BLACK	LED 16W 2628lm 2700K CRI≥90 48V
768711	<b>BLOKINLINE LEDLINE 900</b> WHITE	
768712	<b>BLOKINLINE LEDLINE 900</b> BRASS	
768720	<b>BLOKINLINE LEDLINE 1200</b> BLACK	LED 24W 4122lm 2700K CRI≥90 48V
768721	<b>BLOKINLINE LEDLINE 1200</b> WHITE	
768722	<b>BLOKINLINE LEDLINE 1200</b> BRASS	
768730	<b>BLOKINLINE LEDLINE 1800</b> BLACK	LED 31W 5278lm 2700K CRI≥90 48V
768731	<b>BLOKINLINE LEDLINE 1800</b> WHITE	
768732	<b>BLOKINLINE LEDLINE 1800</b> BRASS	

## BLOKINLINE LEDLINE S 900

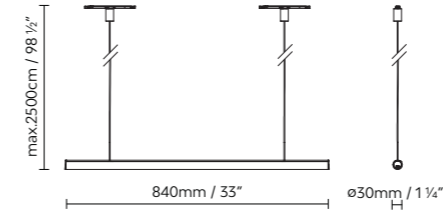

## BLOKINLINE LEDLINE S 1200

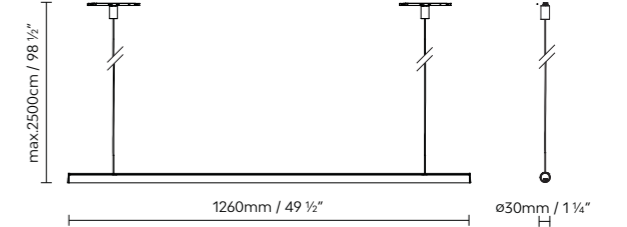

## BLOKINLINE LEDLINE S 1800

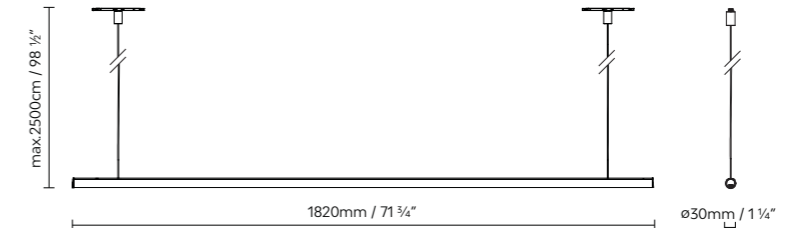

● Black (matte) ● Brass (matte) ○ White (matte)

768800	<b>BLOKINLINE LEDLINE S 900</b> BLACK	LED 16W 2628lm 2700K CRI≥90 48V
768801	<b>BLOKINLINE LEDLINE S 900</b> WHITE	
768802	<b>BLOKINLINE LEDLINE S 900</b> BRASS	
768810	<b>BLOKINLINE LEDLINE S 1200</b> BLACK	LED 24W 4122lm 2700K CRI≥90 48V
768811	<b>BLOKINLINE LEDLINE S 1200</b> WHITE	
768812	<b>BLOKINLINE LEDLINE S 1200</b> BRASS	
768820	<b>BLOKINLINE LEDLINE S 1800</b> BLACK	LED 31W 5278lm 2700K CRI≥90 48V
768821	<b>BLOKINLINE LEDLINE S 1800</b> WHITE	
768822	<b>BLOKINLINE LEDLINE S 1800</b> BRASS	

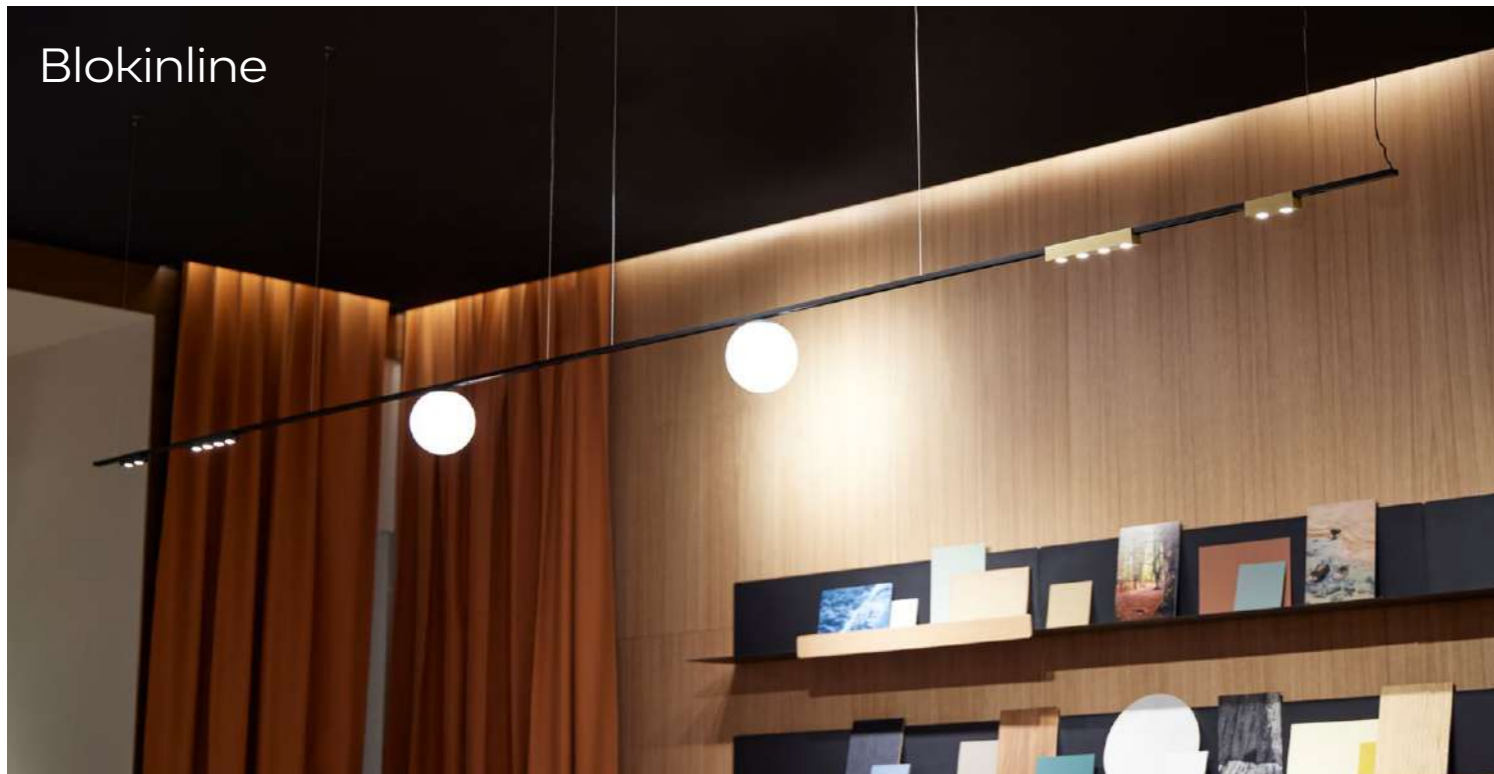

BLOKINLINE SYSTEM DRIVER OPTIONS

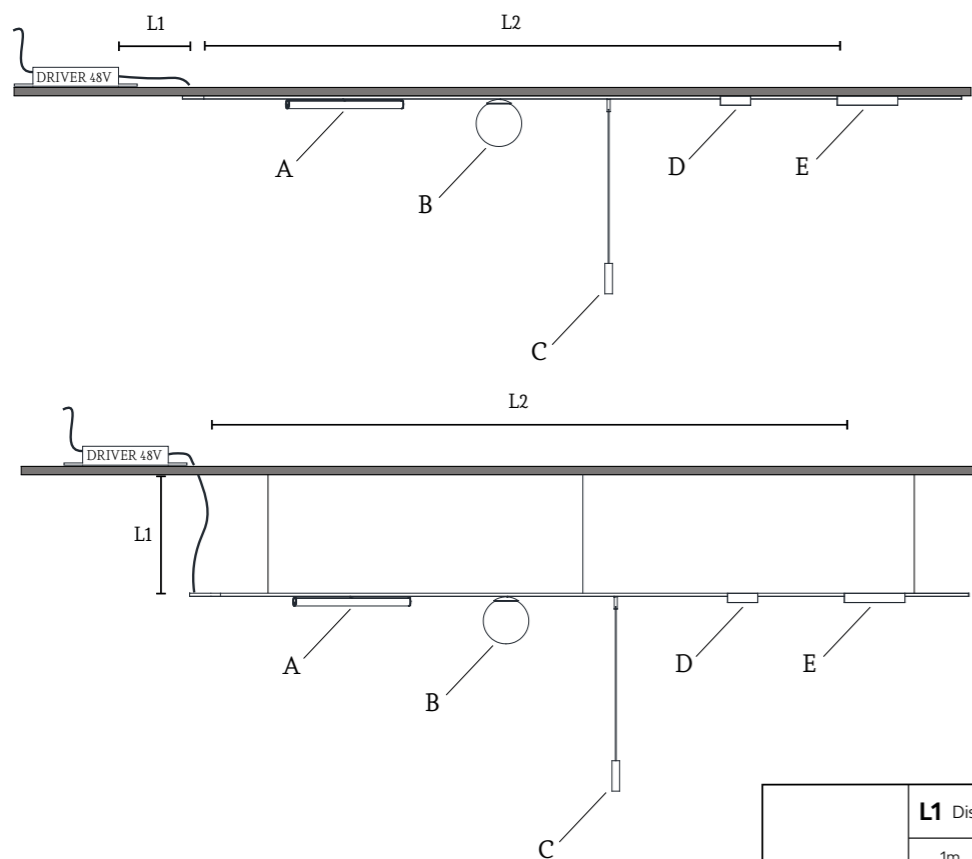

Power supply (W)	L1 Distance power supply/unit in meters (4x0,5mm <sup>2</sup> )			
	1m	3m	5m	10m
	(m)	(m)	(m)	(m)
100	25	20	15	2
120	19	15	9	No admitted

OPTION 1 - BLOKINLINE SYSTEM DRIVER ON TRACK 48V 120W ON-OFF DIM DALI

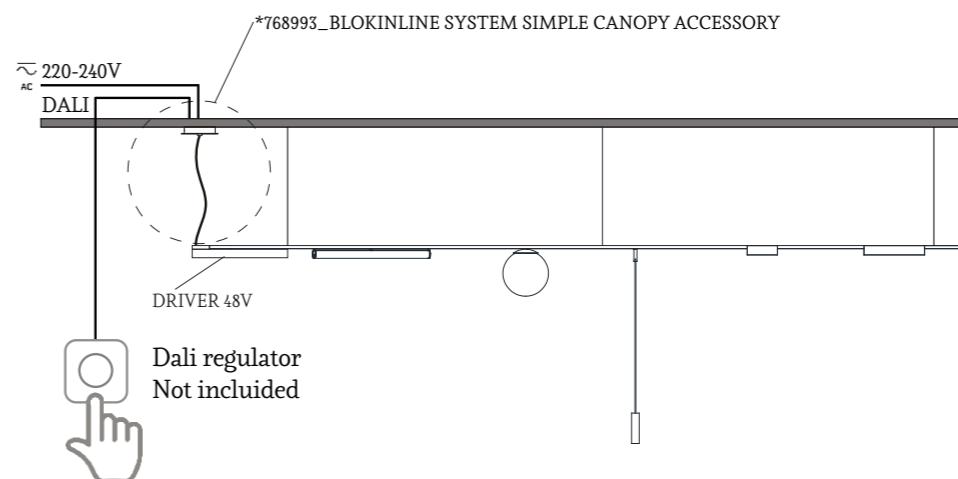
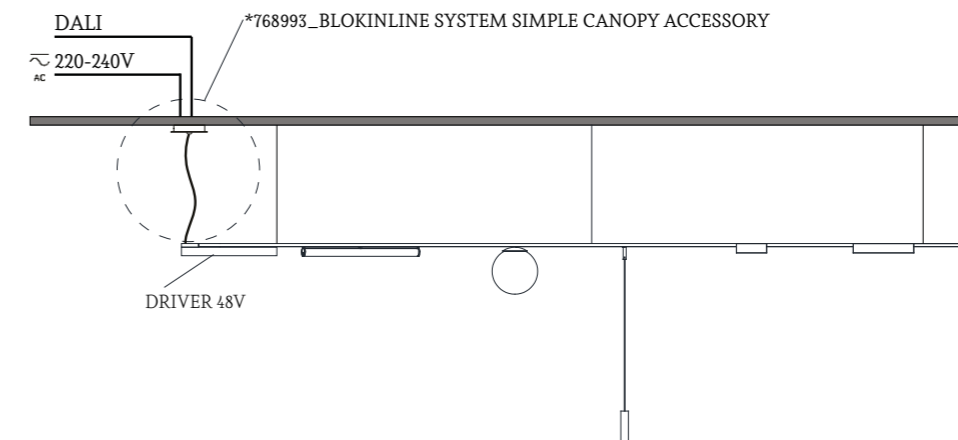
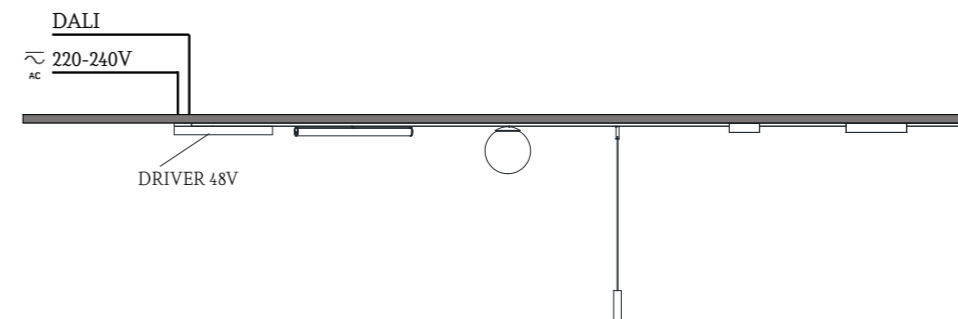



OPTION 2 - BLOKINLINE SYSTEM CANOPY S 48V 120W ON-OF DIM DALI

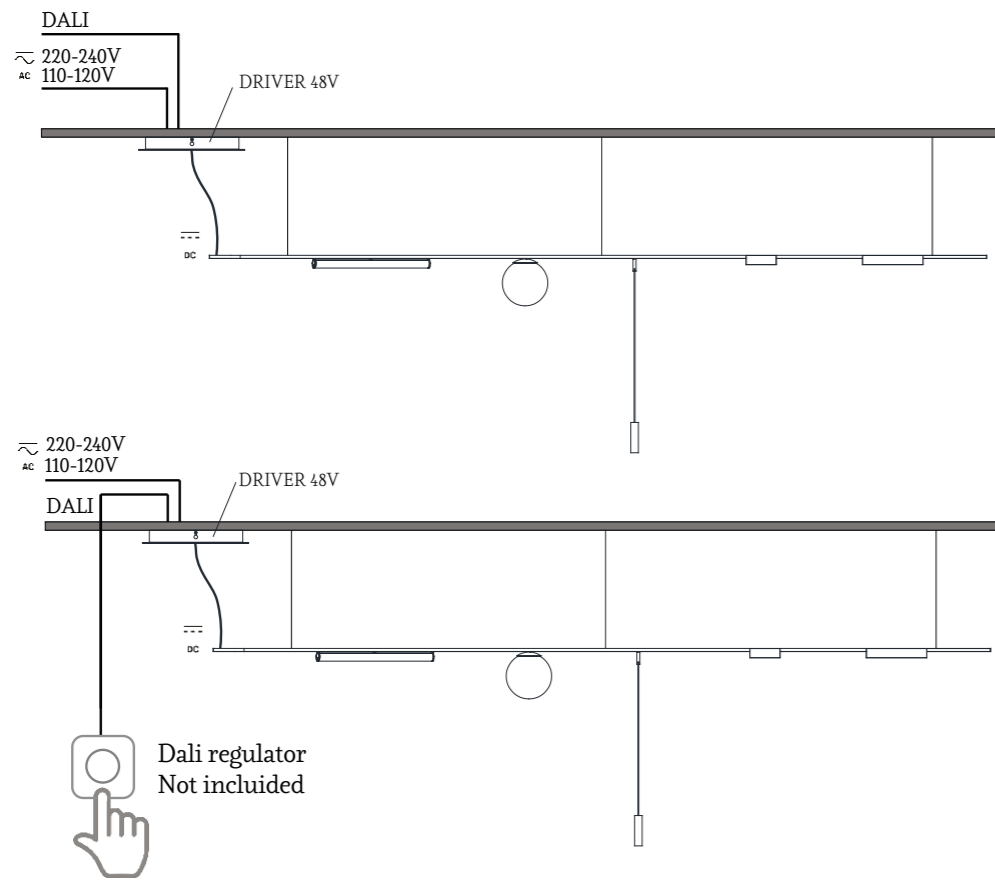

OPTION 4 - BLOKINLINE SYSTEM CANOPY SR 48V 120W ON-OF DIM DALI

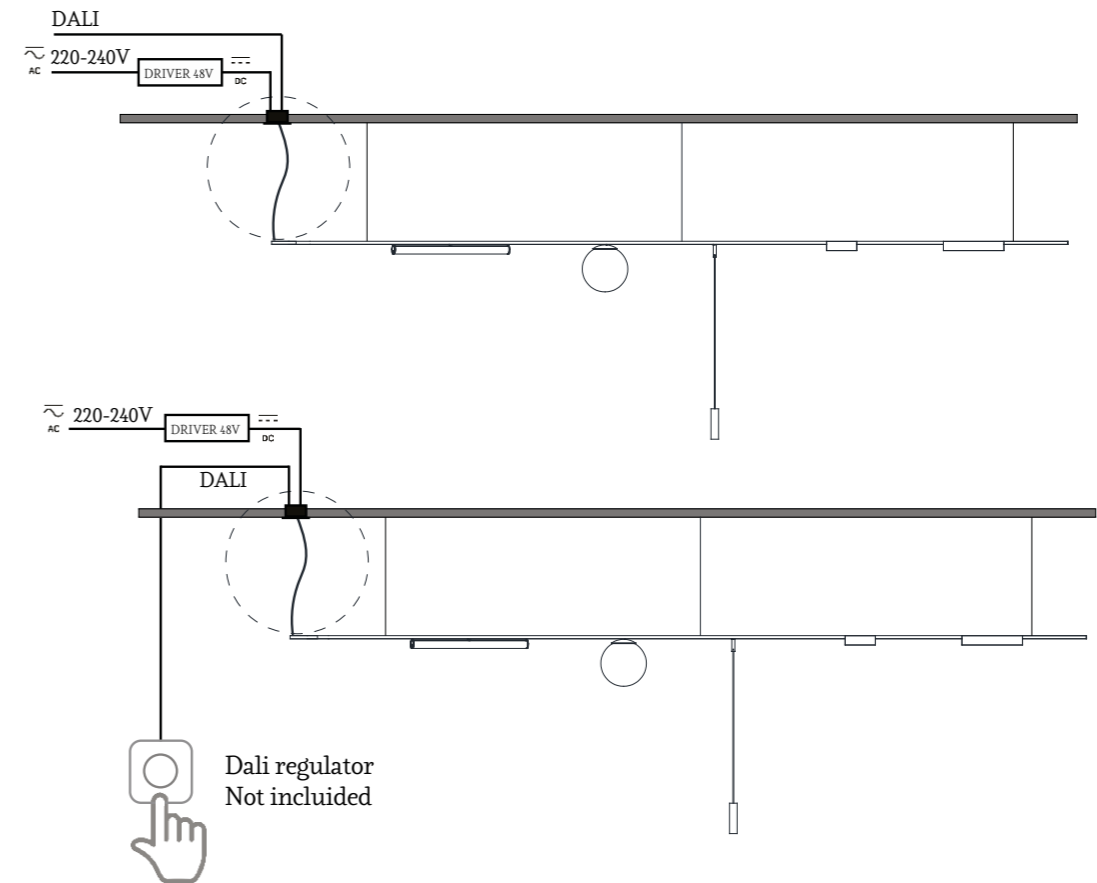

OPTION 3 - BLOKINLINE SYSTEM CANOPY S 48V 120W DIM PUSH

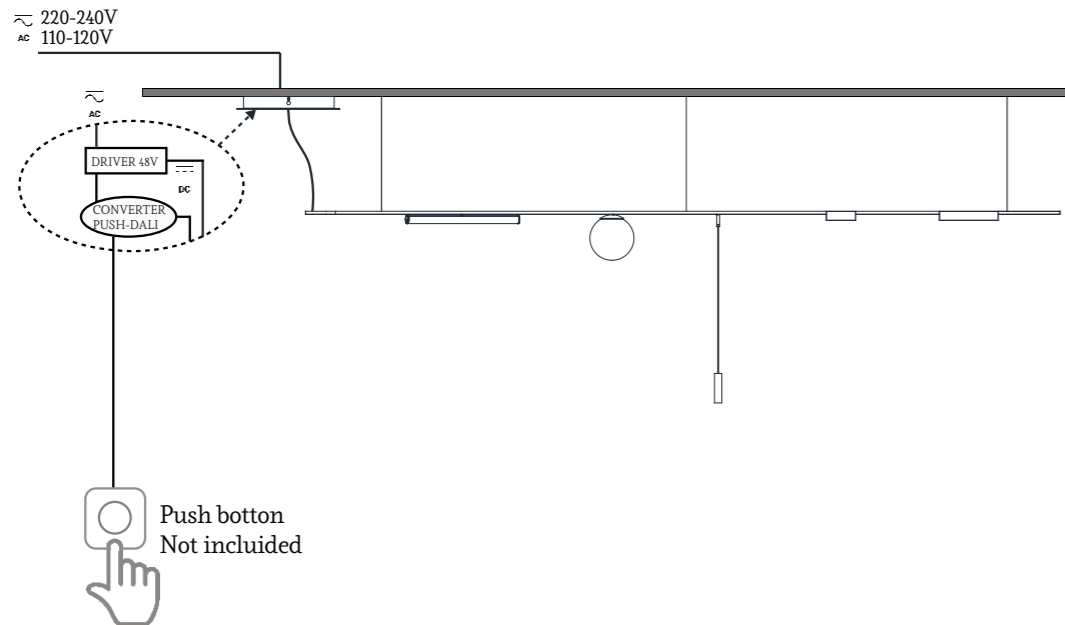

OPTION 5 - BLOKINLINE SYSTEM CANOPY SR 48V 120W DIM PUSH

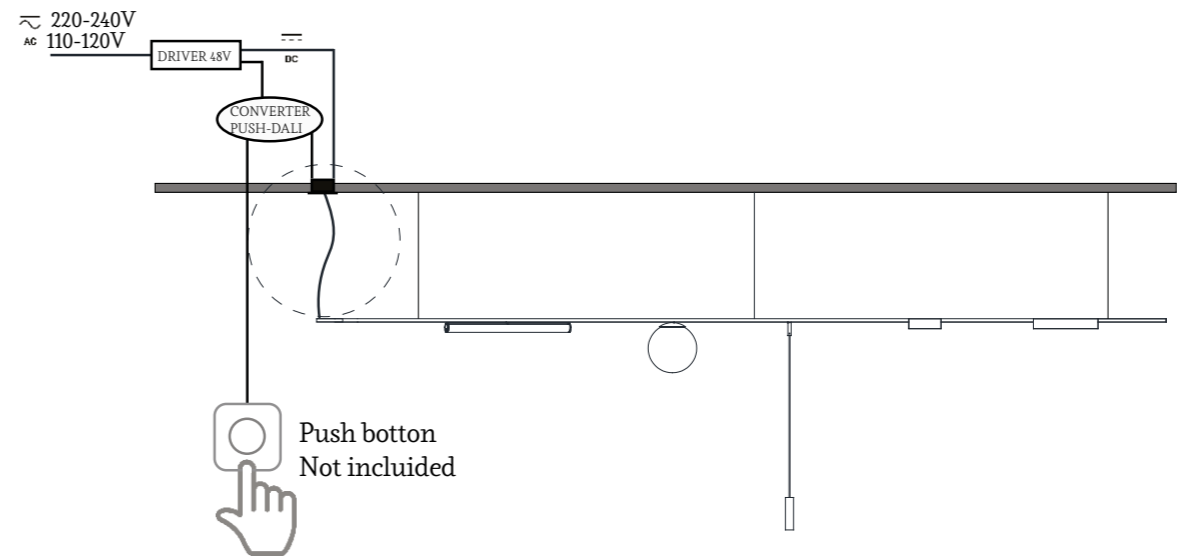

OPTION 6 - BLOKINLINE SYSTEM REMOTE DRIVER 48V 120W ON-OFF DIM DALI

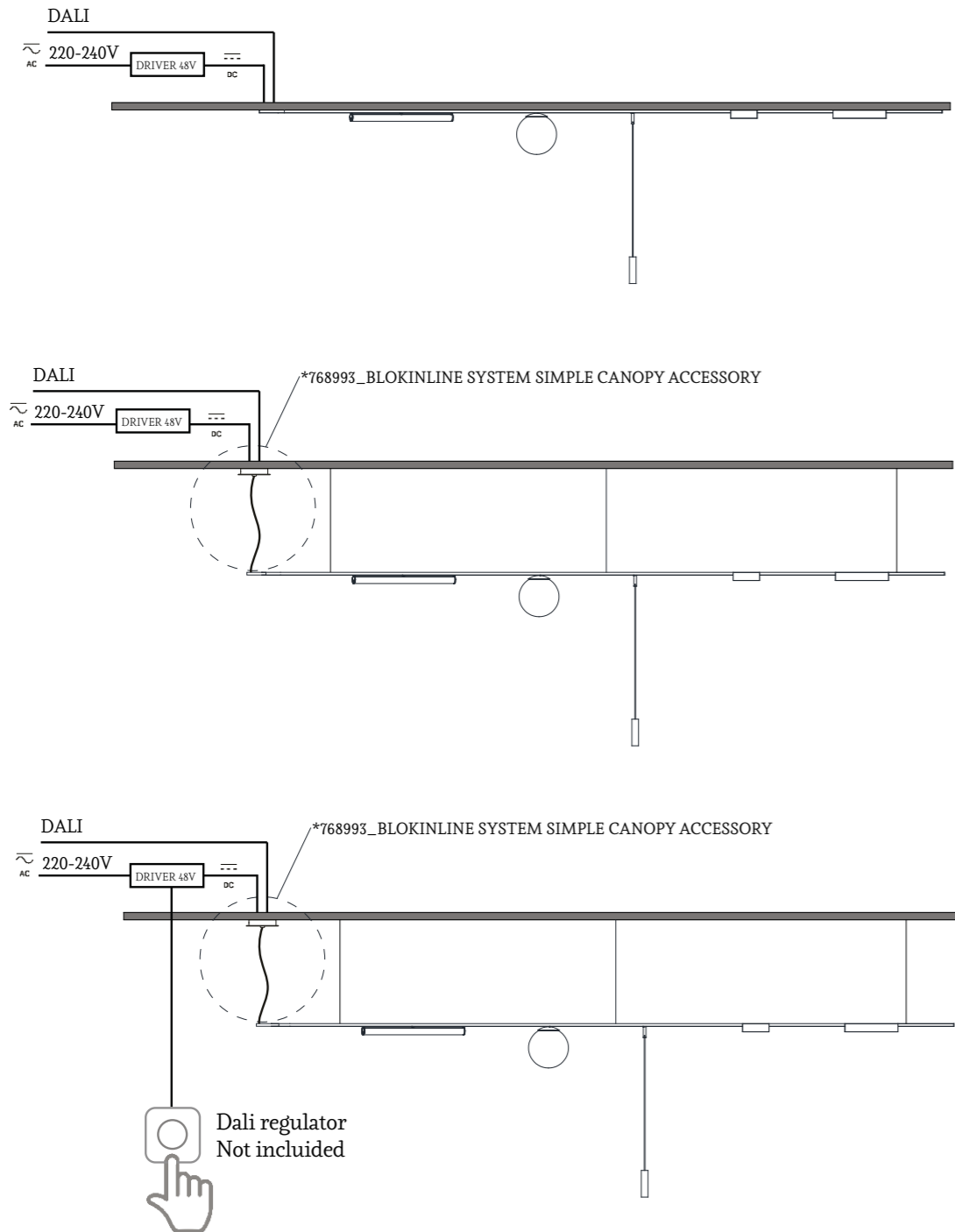

OPTION 7 - BLOKINLINE SYSTEM REMOTE DRIVER 48V 120W ON-OFF DIM DALI

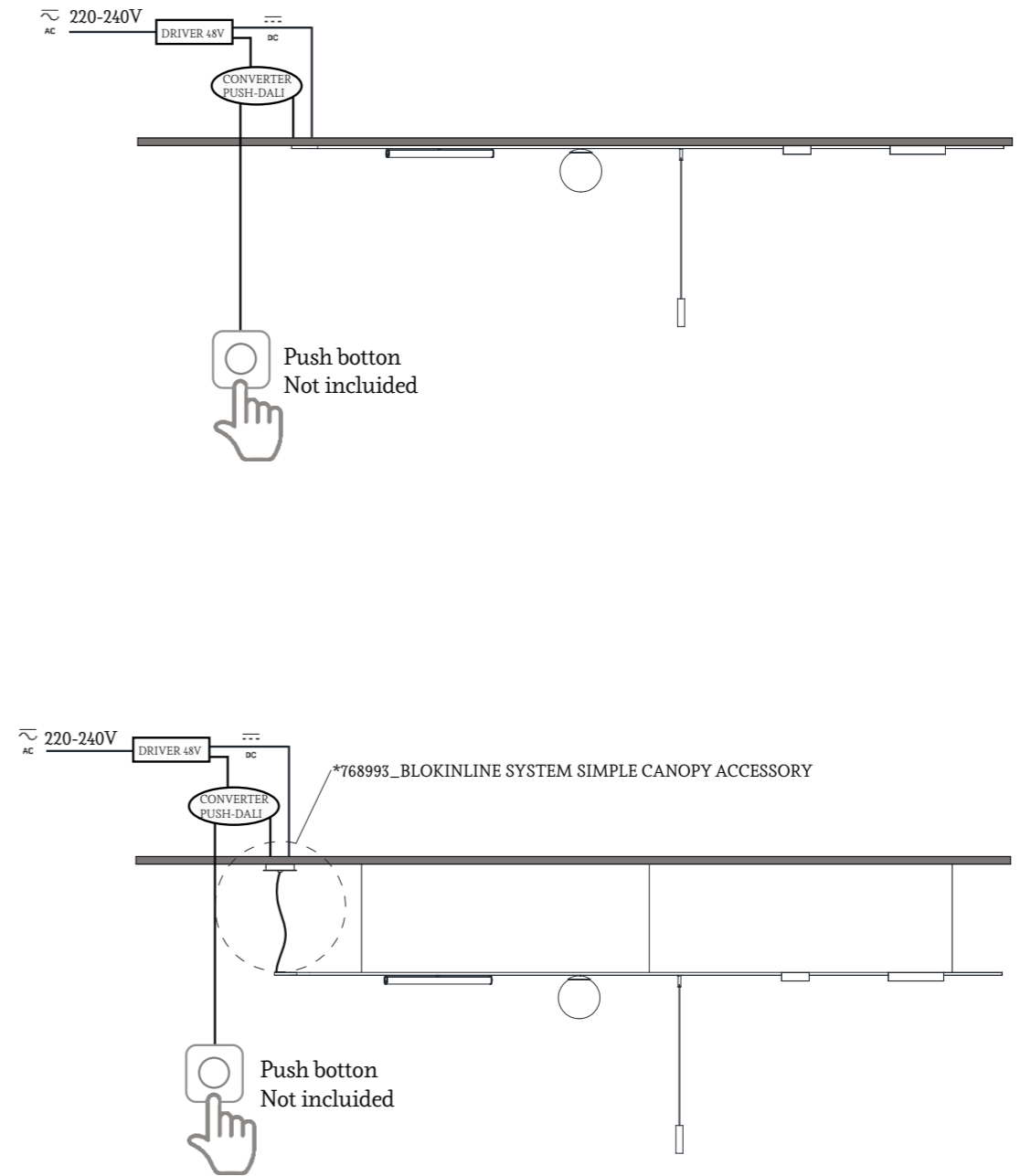





BLOKINLINE INSTALLATION EXAMPLES

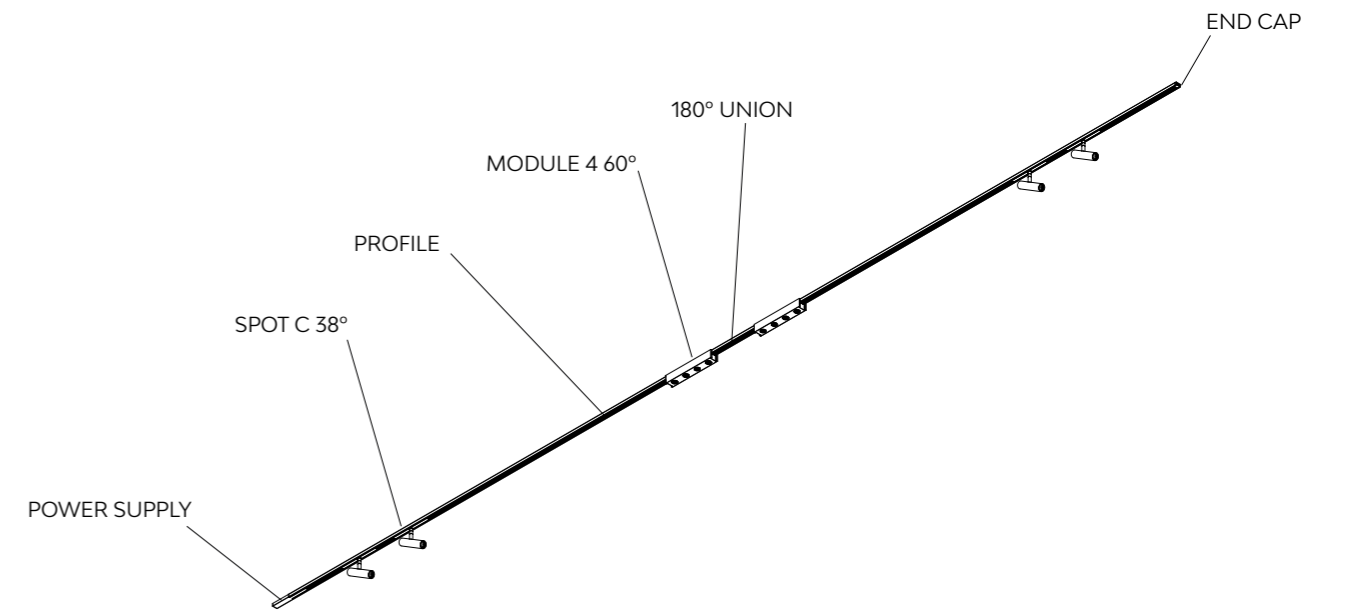
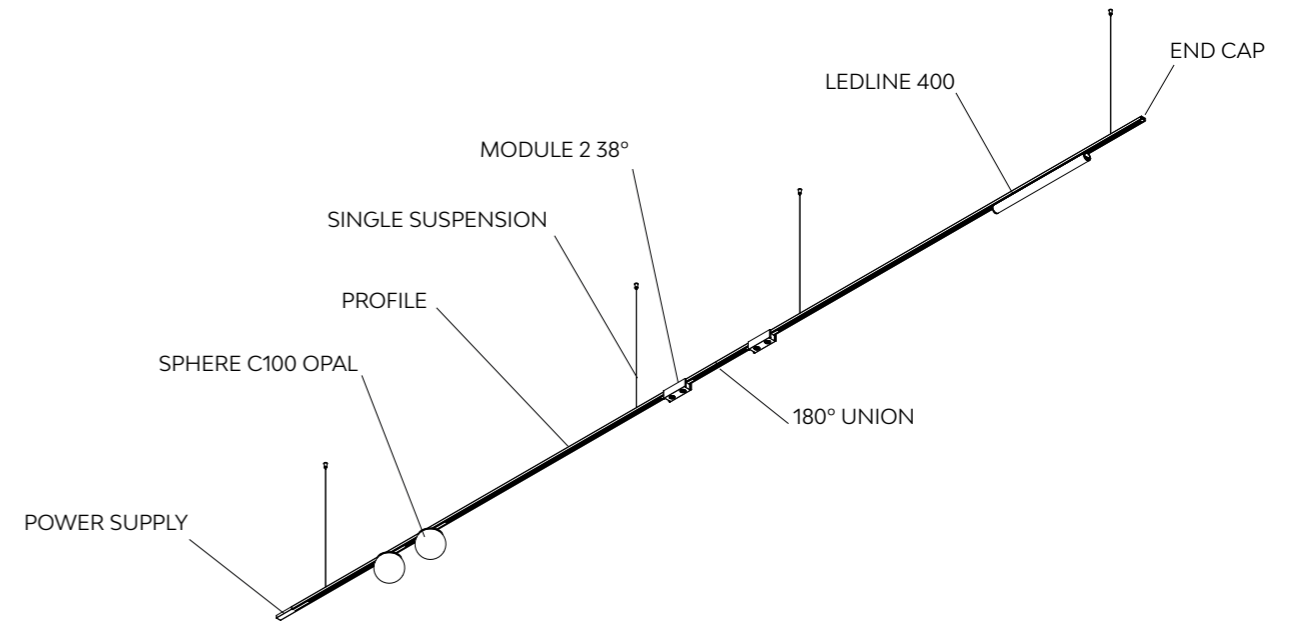

B.lux

# Blokinline Module

Architectural  
lighting

Collection of recessed direct lighting spotlights made of aluminium. They are equipped with a honeycomb panel to prevent glare without affecting the luminaire's high performance. Available in two sizes (Module 2 and Module 4) and with two types of reflectors (38° and 60°). Finishes: matte white, matte black and brass.

Colección de focos empotrados de iluminación directa fabricados en aluminio. Están dotados de un panel de abeja para evitar el deslumbramiento, sin que esto afecte a su alto rendimiento. Disponibles en dos tamaños (Module 2 y Module 4) y dos tipos de reflectores (38° y 60°). Acabados: blanco mate, negro mate y latón.

Kollektion von Aluminium-Unterputzstrahlern für direkte Beleuchtung. Sie sind mit einer Wabenplatte ausgestattet, um Blendung zu vermeiden, ohne dadurch ihre hohe Leistung zu beeinträchtigen. Erhältlich in zwei Größen (Module 2 und Module 4) und zwei Arten von Reflektoren (38° und 60°). Ausführungen: Mattweiß, Mattschwarz und Messing.

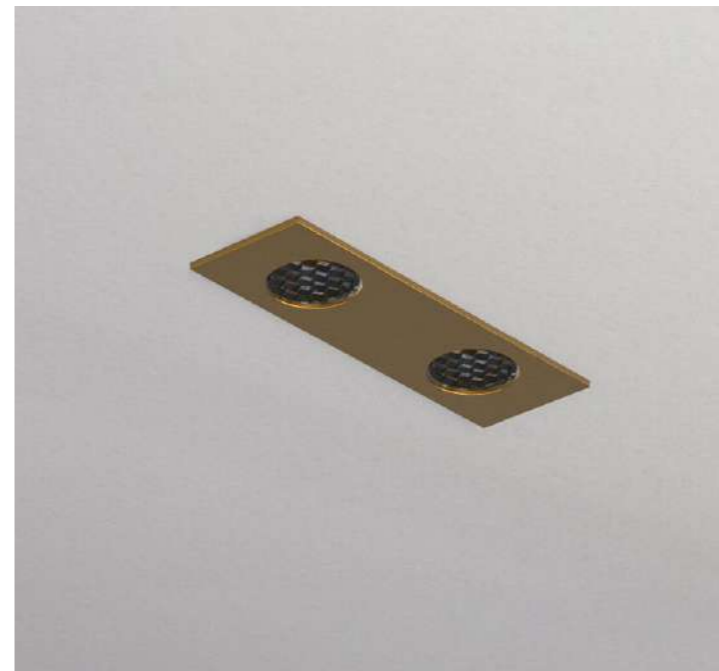

BLOKINLINE MODULE 2 RECESSED

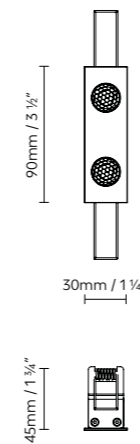

BLOKINLINE MODULE 4 RECESSED

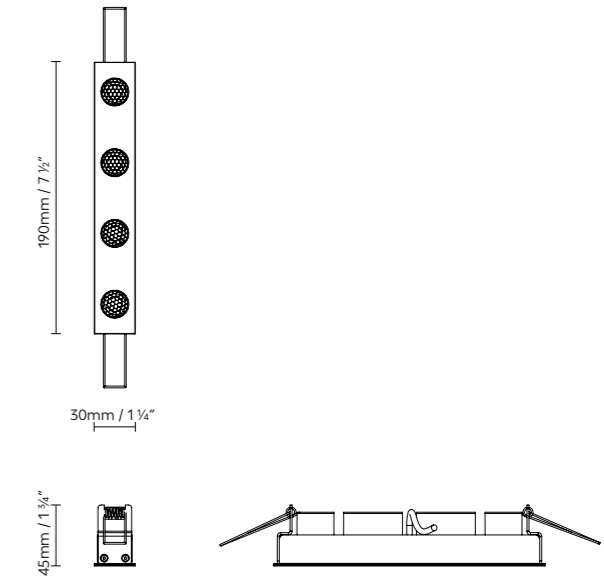

● Black (matte) ● Brass (matte) ○ White (matte)

768000 BLOKINLINE MODULE 2 RECESSED 38° BLACK  
768001 BLOKINLINE MODULE 2 RECESSED 38° WHITE  
768002 BLOKINLINE MODULE 2 RECESSED 38° BRASS  
768010 BLOKINLINE MODULE 2 RECESSED 60° BLACK  
768011 BLOKINLINE MODULE 2 RECESSED 60° WHITE  
768012 BLOKINLINE MODULE 2 RECESSED 60° BRASS

LED 2 x 4,5W 1092lm 250mA 2700K CRI≥90 230V

\* 3000K and 4000K available under request

768020 BLOKINLINE MODULE 4 RECESSED 38° BLACK  
768021 BLOKINLINE MODULE 4 RECESSED 38° WHITE  
768022 BLOKINLINE MODULE 4 RECESSED 38° BRASS  
768030 BLOKINLINE MODULE 4 RECESSED 60° BLACK  
768031 BLOKINLINE MODULE 4 RECESSED 60° WHITE  
768032 BLOKINLINE MODULE 4 RECESSED 60° BRASS

LED 4 x 4,5W 2184lm 250mA 2700K CRI≥90 230V

\* 3000K and 4000K available under request





**B.lux**

# Blokinline LEDtube

**Architectural  
lighting**

Collection of linear luminaires measuring 900, 1200, 1800 and 2400 mm in length and 30 mm in diameter. Their slenderness and the absence of mechanical suspension cables make Blokinline LEDtube a tremendously light luminaire in visual terms, but one which also offers high lighting power. Finishes: matte white, matte black and brass.

Colección de luminarias lineales de 900, 1200, 1800 y 2400mm de longitud y 30mm de diámetro. Su esbeltez y la ausencia de cables mecánicos de suspensión hacen Blokinline LEDtube una luminaria tremendamente ligera visualmente, pero con un alto poder lumínico. Acabados: blanco mate, negro mate, y latón.

Kollektion von linearen Leuchten mit 900, 1200, 1800 und 2400 mm Länge und 30 mm Durchmesser. Dank des schlanken Designs und der Vermeidung mechanischer Aufhängekabel ist Blokinline LEDtube eine optisch extrem leichte Leuchte, die jedoch eine hohe Leuchtkraft aufweist. Ausführungen: Mattweiß, Mattschwarz und Messing.







**BLOKINLINE LEDTUBE S 900**

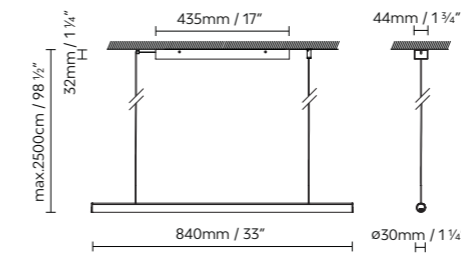

**BLOKINLINE LEDTUBE S 1200**

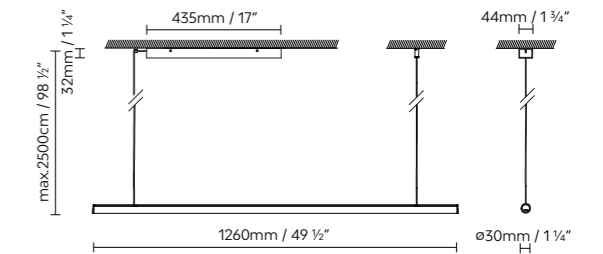

**BLOKINLINE LEDTUBE S 1800**

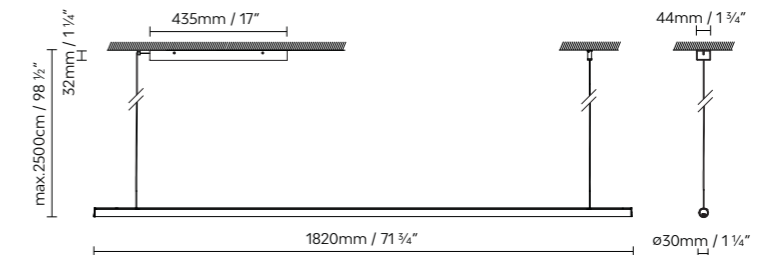

- Black (matte)
- Brass (matte)
- White (matte)

768800T	<b>BLOKINLINE LEDTUBE S 900 BLACK</b>	LED 16W 2628lm 350mA 2700K CRI≥90 230V DIM PUSH/DALI
768801T	<b>BLOKINLINE LEDTUBE S 900 WHITE</b>	
768802T	<b>BLOKINLINE LEDTUBE S 900 BRASS</b>	
768810T	<b>BLOKINLINE LEDTUBE S 1200 BLACK</b>	LED 23W 3942lm 525mA 2700K CRI≥90 230V DIM PUSH/DALI
768811T	<b>BLOKINLINE LEDTUBE S 1200 WHITE</b>	
768812T	<b>BLOKINLINE LEDTUBE S 1200 BRASS</b>	
768820T	<b>BLOKINLINE LEDTUBE S 1800 BLACK</b>	LED 31W 5278lm 700mA 2700K CRI≥90 230V DIM PUSH/DALI
768821T	<b>BLOKINLINE LEDTUBE S 1800 WHITE</b>	
768822T	<b>BLOKINLINE LEDTUBE S 1800 BRASS</b>	





Blokinline



BLOKINLINE LEDTUBE S 2400

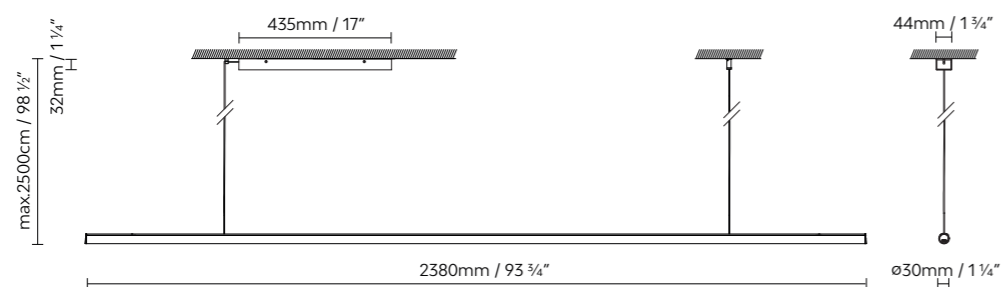

● Black (matte) ● Brass (matte) ○ White (matte)

768830T BLOKINLINE LEDTUBE 2400 BLACK  
 768831T BLOKINLINE LEDTUBE 2400 WHITE  
 768832T BLOKINLINE LEDTUBE 2400 BRASS

LED 46W 787lm 1050mA 2700K CRI≥90 230V DIM PUSH/DALI





**B.lux**

# Sis System

by **María Güell  
& Carrasquet**

**Architctural  
lighting**

SIS is a three-dimensional lighting system based on a compact 24 V electrified track (18 mm in diameter). It allows individual, high luminous flux spotlights to be installed and freely positioned along the track's entire length. The system is available in a suspension version.

SIS has different light sources: downlights with lenses in varying angles of aperture (24° 36° and 60°), pivotable projectors (24°, 36° and 60°) and a decorative opal glass spotlight. The system also has a striated glass accessory that adapts to the downlights.

The light sources in the SIS System collection are available in brass, black, grey and white finishes, while the track always comes in black.

SIS es un sistema de iluminación tridimensional basado en un carril electrificado a 24V de tamaño compacto (18mm de diámetro). Permite incorporar spots individuales de alto flujo lumínico que pueden posicionarse de forma libre a lo largo de todo el carril. El sistema está disponible en versión suspensión.

SIS cuenta con diferentes fuentes de luz, spots downlight con ópticas de diferentes ángulos de apertura (24°, 36° y 60°), proyectores orientables (24°, 36° y 60°), y un spot decorativo de vidrio opalino. A la colección del sistema se suma el accesorio de cristal estriado adaptable a los focos downlight.

Las fuentes de luz de la colección SIS System están disponibles en los acabados latón, negro, gris y blanco, mientras que el carril siempre se muestra en acabado negro.

SIS ist ein dreidimensionale Beleuchtungssystem auf einer kompakten 24-V-Stromschiene (18 mm Durchmesser) Es erlaubt die Integration einzelner Lichtpunkte mit hoher Intensität, die entlang der gesamten Schiene frei positioniert werden können. Das System ist auch in hängender Version erhältlich.

SIS verfügt über verschiedene Lichtquellen: Downlight-Lichtpunkte mit unterschiedlichen Öffnungswinkeln (24°, 36° und 60°), verstellbare Strahler (24°, 36° und 60°) und einen dekorativen Lichtpunkt aus Opalglas. Als Ergänzung umfasst die Kollektion des Systems ein Zubehör aus geriffeltem Glas, das an die Downlight-Strahler angepasst werden kann.

Die Lichtquellen der Kollektion SIS System sind in den Ausführungen Messing, Schwarz, grau und Weiß erhältlich, während die Schiene immer schwarz ist.





# Sis System

## SIS SYSTEM SUSPENSION PROFILE S UNI

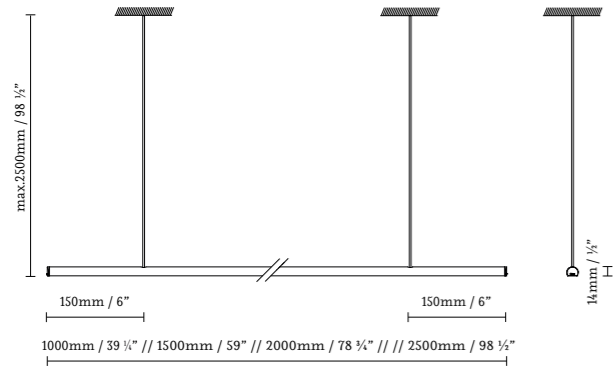

## SIS SYSTEM SUSPENSION PROFILE S DEP

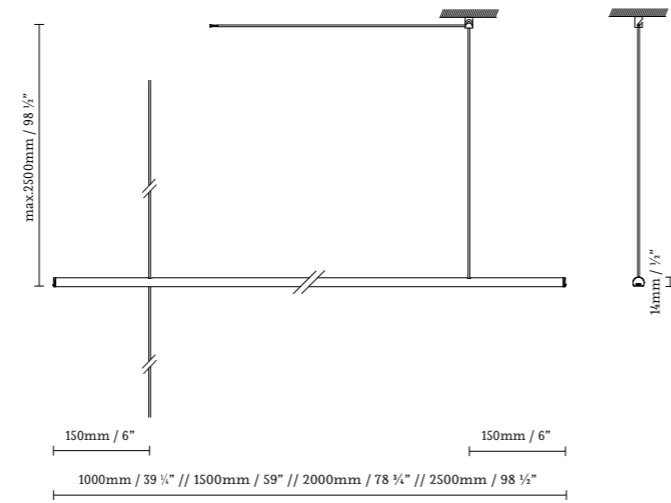

## SIS SYSTEM SINGLE CANOPY SURFACE

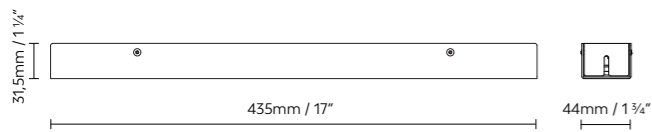

## sis SYSTEM MULTIPLE CANOPY SURFACE

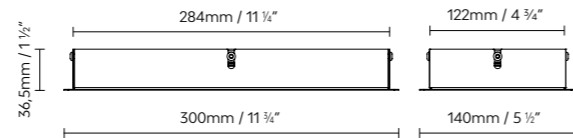

○ White (matte) ● Black (matte) ● Brass (mate)

771100	SIS SYSTEM SUSPENSION PROFILE S100 UNI BLACK	24V	
771101	SIS SYSTEM SUSPENSION PROFILE S100 UNI WHITE		
771110	SIS SYSTEM SUSPENSION PROFILE S150 UNI BLACK		
771111	SIS SYSTEM SUSPENSION PROFILE S150 UNI WHITE		
771120	SIS SYSTEM SUSPENSION PROFILE S200 UNI BLACK		
771121	SIS SYSTEM SUSPENSION PROFILE S200 UNI WHITE		
771130	SIS SYSTEM SUSPENSION PROFILE S250 UNI BLACK	24V	
771131	SIS SYSTEM SUSPENSION PROFILE S250 UNI WHITE		
771200	SIS SYSTEM SUSPENSION PROFILE S100 DEP BLACK		
771201	SIS SYSTEM SUSPENSION PROFILE S100 DEP WHITE		
771210	SIS SYSTEM SUSPENSION PROFILE S150 DEP BLACK		
771211	SIS SYSTEM SUSPENSION PROFILE S150 DEP WHITE		
771220	SIS SYSTEM SUSPENSION PROFILE S200 DEP BLACK	24V	
771221	SIS SYSTEM SUSPENSION PROFILE S200 DEP WHITE		
771230	SIS SYSTEM SUSPENSION PROFILE S250 DEP BLACK		
771231	SIS SYSTEM SUSPENSION PROFILE S250 DEP WHITE		
771900	SIS SYSTEM SINGLE CANOPY SURFACE BLACK		24V DC 60W 230V
771901	SIS SYSTEM SINGLE CANOPY SURFACE WHITE		
771910	SIS SYSTEM MULTIPLE CANOPY SURFACE BLACK	24V DC 200W 230V	
771911	SIS SYSTEM MULTIPLE CANOPY SURFACE WHITE		



## SIS SYSTEM SPOT

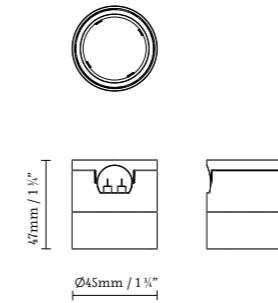

## SIS SYSTEM SPOTLIGHT

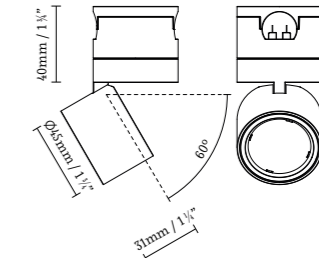

○ White (matte) ● Black (matte) ● Brass (mate) ● Grey (matte)

771300	SIS SYSTEM SPOT 24° BLACK	LED 6,3W 627lm 350mA 2700K CRI≥90
771301	SIS SYSTEM SPOT 24° WHITE	
771302	SIS SYSTEM SPOT 24° BRASS	
771303	SIS SYSTEM SPOT 24° GREY	
771310	SIS SYSTEM SPOT 36° BLACK	LED 6,3W 627lm 350mA 2700K CRI≥90
771311	SIS SYSTEM SPOT 36° WHITE	
771312	SIS SYSTEM SPOT 36° BRASS	
771313	SIS SYSTEM SPOT 36° GREY	
771320	SIS SYSTEM SPOT 60° BLACK	LED 6,3W 627lm 350mA 2700K CRI≥90
771321	SIS SYSTEM SPOT 60° WHITE	
771322	SIS SYSTEM SPOT 60° BRASS	
771323	SIS SYSTEM SPOT 60° GREY	
771330	SIS SYSTEM SPOTLIGHT 24° BLACK	LED 6,3W 627lm 350mA 2700K CRI≥90
771331	SIS SYSTEM SPOTLIGHT 24° WHITE	
771332	SIS SYSTEM SPOTLIGHT 24° BRASS	
771333	SIS SYSTEM SPOTLIGHT 24° GREY	
771340	SIS SYSTEM SPOTLIGHT 36° BLACK	LED 6,3W 627lm 350mA 2700K CRI≥90
771341	SIS SYSTEM SPOTLIGHT 36° WHITE	
771342	SIS SYSTEM SPOTLIGHT 36° BRASS	
771343	SIS SYSTEM SPOTLIGHT 36° GREY	
771350	SIS SYSTEM SPOTLIGHT 60° BLACK	LED 6,3W 627lm 350mA 2700K CRI≥90
771351	SIS SYSTEM SPOTLIGHT 60° WHITE	
771352	SIS SYSTEM SPOTLIGHT 60° BRASS	
771353	SIS SYSTEM SPOTLIGHT 60° GREY	

# Sis System



## SIS SYSTEM SPOT OPAL GLASS DIFFUSER

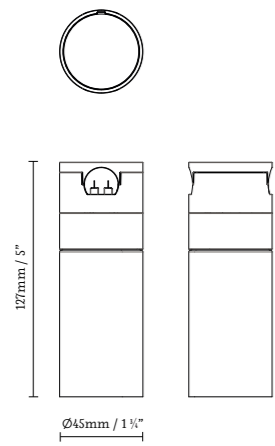

## SIS SYSTEM SPOT GROOVE GLASS DIFFUSER ACCESSORY

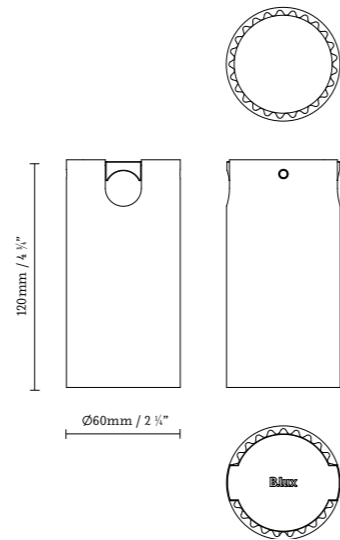

○ White (matte) ● Black (matte) ● Brass (mate) ● Grey (matte)

771370 SIS SYSTEM SPOT OPAL GLASS DIFFUSER BLACK  
 771371 SIS SYSTEM SPOT OPAL GLASS DIFFUSER WHITE  
 771372 SIS SYSTEM SPOT OPAL GLASS DIFFUSER BRASS  
 771373 SIS SYSTEM SPOT OPAL GLASS DIFFUSER GREY

LED 6,3W 627lm 350mA 2700K CRI≥90

771950 SIS SYSTEM SPOT GROOVE GLASS DIFFUSER ACCESSORY

## SIS SYSTEM INSTALLATION EXAMPLES

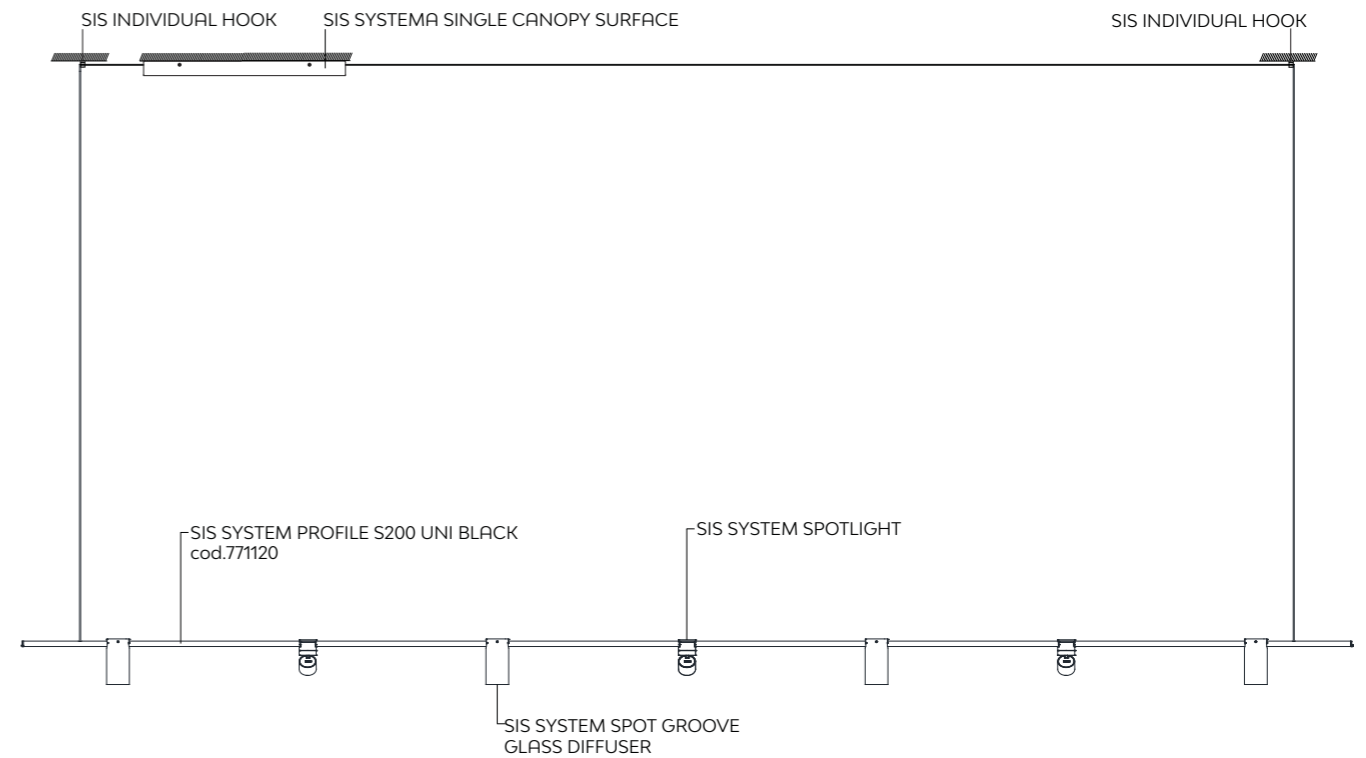





SIS SYSTEM INSTALLATION EXAMPLES

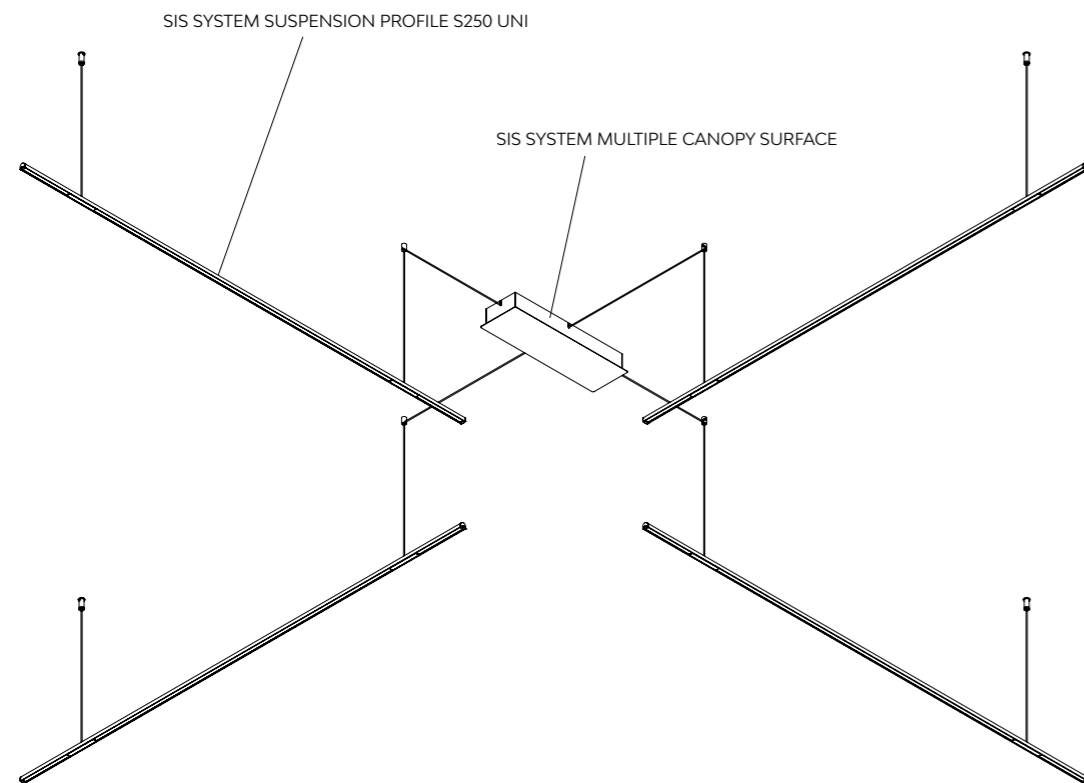

SIS SYSTEM INSTALLATION EXAMPLES

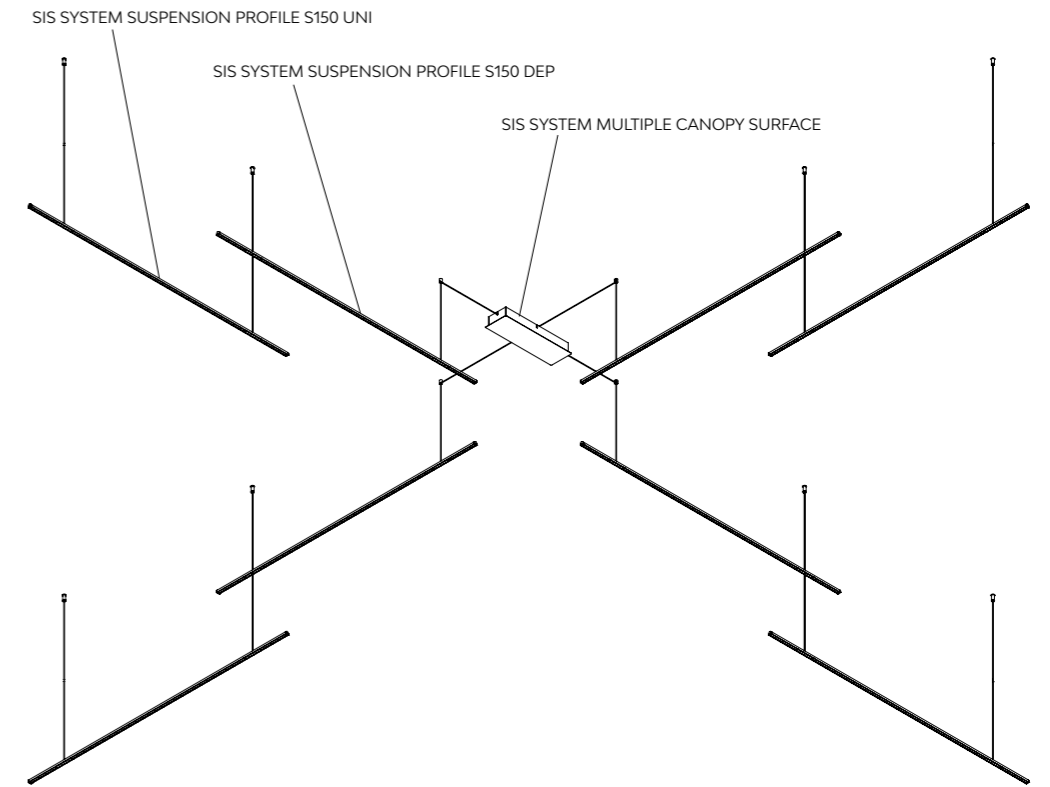

## SIS SYSTEM INSTALLATION EXAMPLES

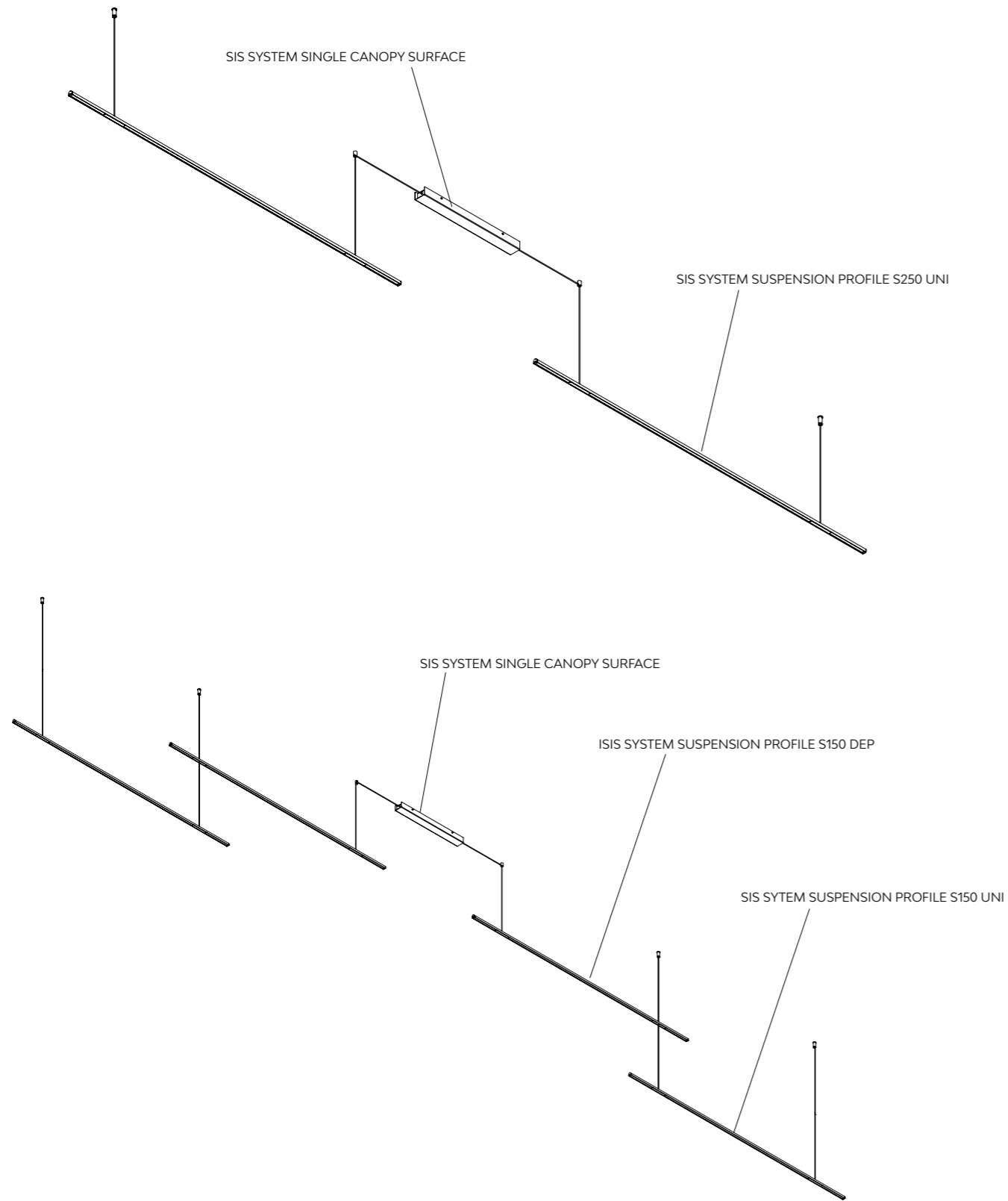

## SIS SYSTEM INSTALLATION EXAMPLES

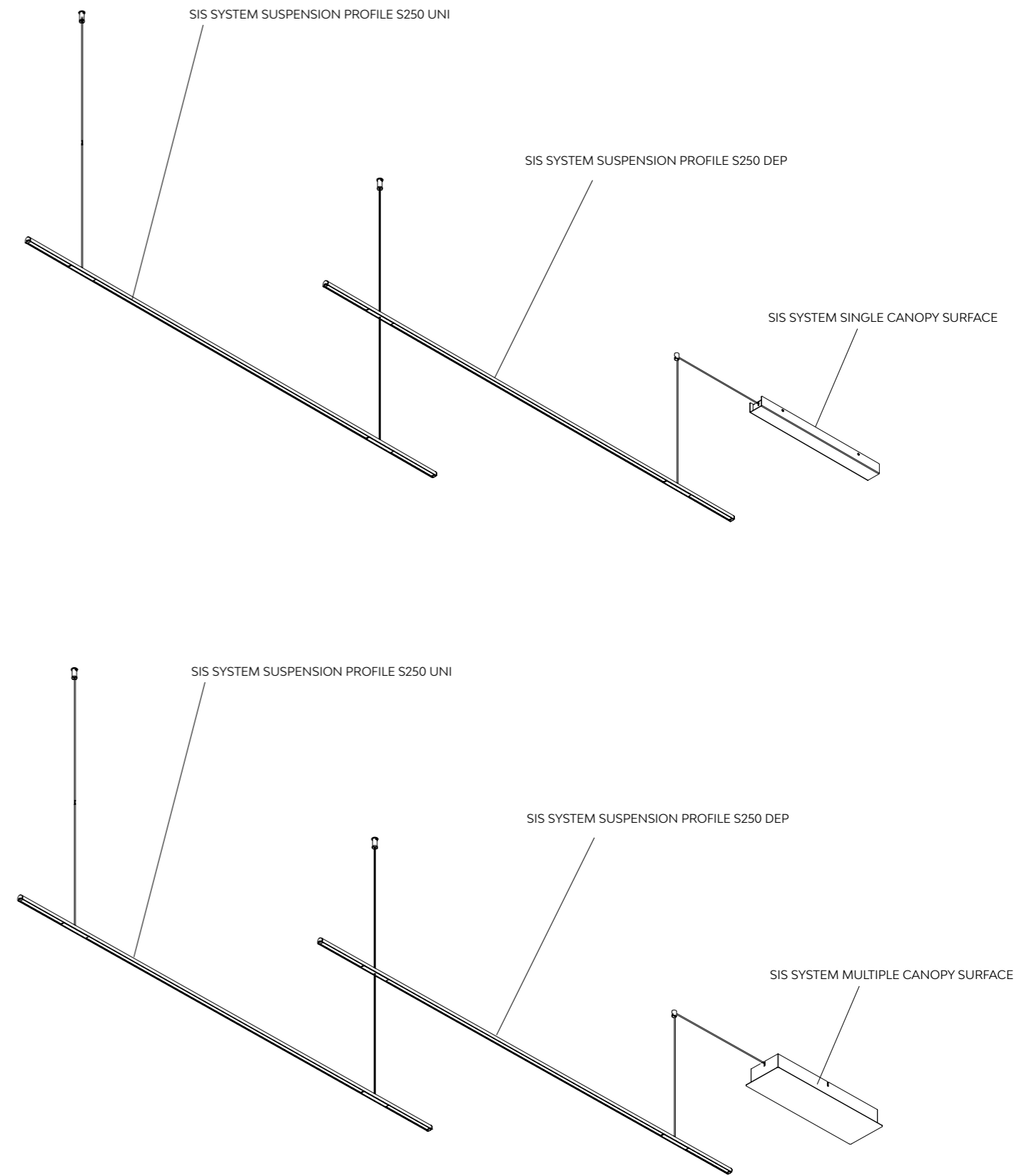



**B.lux**

# Sis Spot

by María Güell  
& Carrasquet

Architectural  
lighting

Collection of surface and pendant spotlights manufactured in aluminium, for direct and focused lighting. They have lenses with different angles of aperture (24°, 36° and 60°). The pendant version has the options of opal glass and a striated glass accessory. SIS is available in white, black, grey and brass finishes.

Colección de focos en superficie y suspendidos fabricados en aluminio, de iluminación directa y orientables. Cuentan con ópticas de diferentes ángulos de apertura (24°, 36° y 60°). La versión suspensión cuenta con las opciones de vidrio opalino y el accesorio de vidrio estriado. SIS está disponible en los acabados blanco, negro, gris y latón.

Kollektion von Stahlern in Aufputz- und Hängeversion aus Aluminium für direkte und ausrichtbare Beleuchtung. Die Optiken sind mit unterschiedlichen Öffnungswinkeln (24°, 36° und 60°) erhältlich. Für die Hängeversion gibt es die Optionen Opalglas und Zubehör aus geriffeltem Glas. SIS ist in den Ausführungen Weiß, Schwarz, grau und Messing.



# Sis Spot

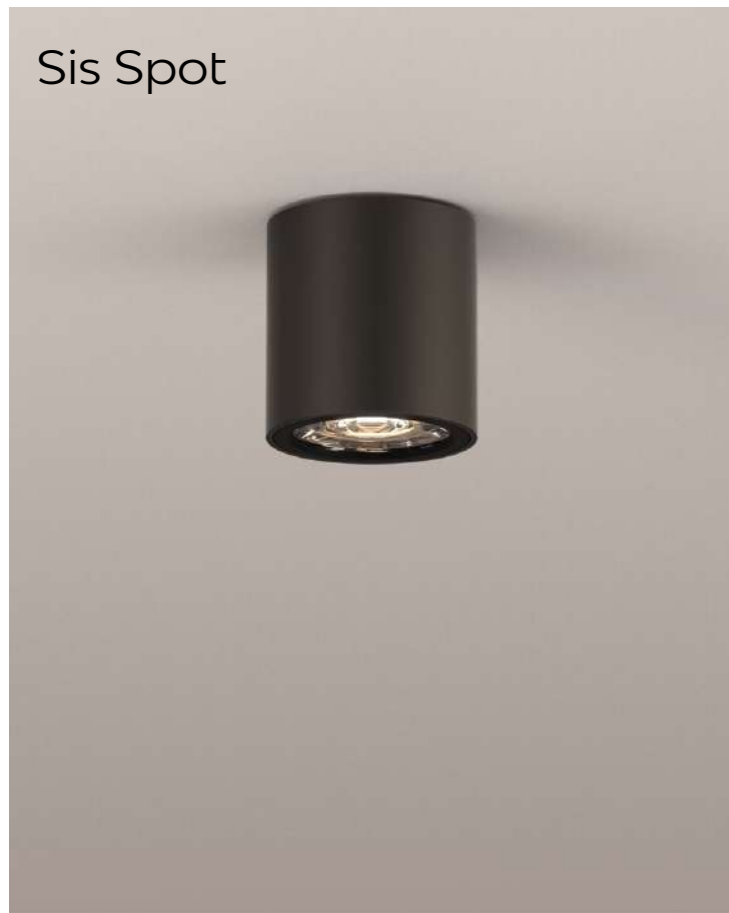

## SIS SPOT C D40

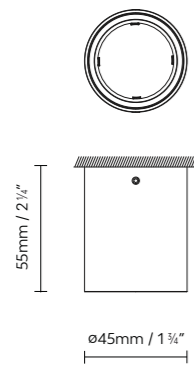

## SIS SPOTLIGHT C D40

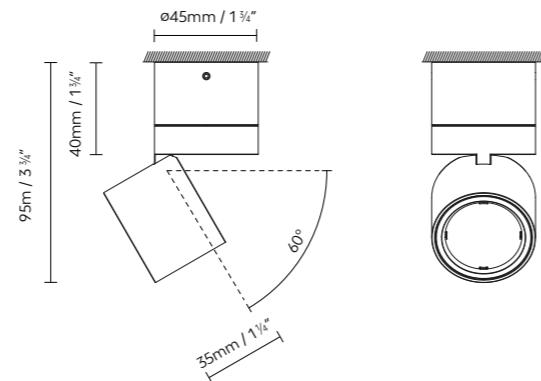

## SIS SPOT C D60

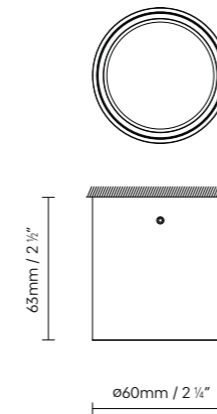

## SIS SPOTLIGHT C D60

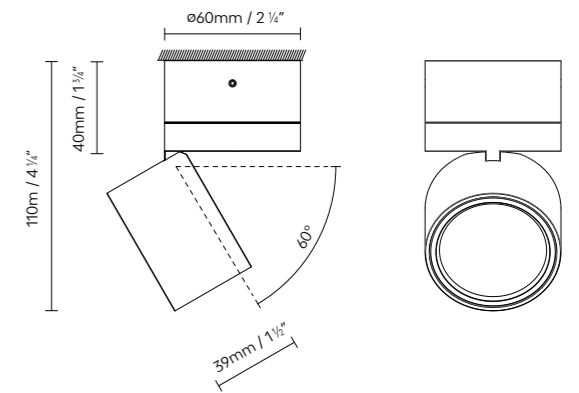

● Black (matte) ● Brass (matte) ○ White (matte) ● Grey (matte)

● Black (matte) ● Brass (matte) ○ White (matte) ● Grey (matte)

771500	<b>SIS SPOT C D40 24°</b> BLACK	
771501	<b>SIS SPOT C D40 24°</b> WHITE	LED 4W 350lm 2700K
771502	<b>SIS SPOT C D40 24°</b> BRASS	CRI≥90 230V
771503	<b>SIS SPOT C D40 24°</b> GREY	

771530	<b>SIS SPOTLIGHT C D40 24°</b> BLACK	
771531	<b>SIS SPOTLIGHT C D40 24°</b> WHITE	LED 4W 350lm
771532	<b>SIS SPOTLIGHT C D40 24°</b> BRASS	2700K CRI≥90 230V
771533	<b>SIS SPOTLIGHT C D40 24°</b> GREY	

771510	<b>SIS SPOT C D40 36°</b> BLACK	
771511	<b>SIS SPOT C D40 36°</b> WHITE	LED 4W 350lm 2700K
771512	<b>SIS SPOT C D40 36°</b> BRASS	CRI≥90 230V
771513	<b>SIS SPOT C D40 36°</b> GREY	

771540	<b>SIS SPOTLIGHT C D40 36°</b> BLACK	
771541	<b>SIS SPOTLIGHT C D40 36°</b> WHITE	LED 4W 350lm
771542	<b>SIS SPOTLIGHT C D40 36°</b> BRASS	2700K CRI≥90 230V
771543	<b>SIS SPOTLIGHT C D40 36°</b> GREY	

771520	<b>SIS SPOT C D40 60°</b> BLACK	
771521	<b>SIS SPOT C D40 60°</b> WHITE	LED 4W 350lm 2700K
771522	<b>SIS SPOT C D40 60°</b> BRASS	CRI≥90 230V
771523	<b>SIS SPOT C D40 60°</b> GREY	

771550	<b>SIS SPOTLIGHT C D40 60°</b> BLACK	
771551	<b>SIS SPOTLIGHT C D40 60°</b> WHITE	LED 4W 350lm
771552	<b>SIS SPOTLIGHT C D40 60°</b> BRASS	2700K CRI≥90 230V
771553	<b>SIS SPOTLIGHT C D40 60°</b> GREY	

771560	<b>SIS SPOT C D60 26°</b> BLACK	
771561	<b>SIS SPOT C D60 26°</b> WHITE	LED 8W 635lm 2700K
771562	<b>SIS SPOT C D60 26°</b> BRASS	CRI≥90 230V
771563	<b>SIS SPOT C D60 26°</b> GREY	

771580	<b>SIS SPOTLIGHT C D60 26°</b> BLACK	
771581	<b>SIS SPOTLIGHT C D60 26°</b> WHITE	LED 8W 635lm
771582	<b>SIS SPOTLIGHT C D60 26°</b> BRASS	2700K CRI≥90 230V
771583	<b>SIS SPOTLIGHT C D60 26°</b> GREY	

771570	<b>SIS SPOT C D60 60°</b> BLACK	
771571	<b>SIS SPOT C D60 60°</b> WHITE	LED 8W 635lm 2700K
771572	<b>SIS SPOT C D60 60°</b> BRASS	CRI≥90 230V
771573	<b>SIS SPOT C D60 60°</b> GREY	

771590	<b>SIS SPOTLIGHT C D60 60°</b> BLACK	
771591	<b>SIS SPOTLIGHT C D60 60°</b> WHITE	LED 8W 635lm
771592	<b>SIS SPOTLIGHT C D60 60°</b> BRASS	2700K CRI≥90 230V
771593	<b>SIS SPOTLIGHT C D60 60°</b> GREY	



# Sis Spot



## SIS SPOT S D40

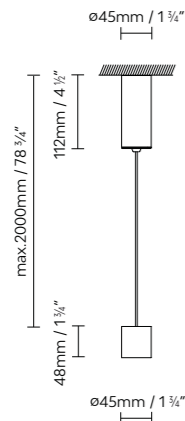

## SIS SPOT SR D40

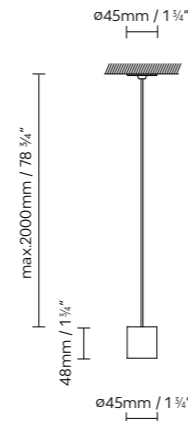

● Black (matte) ● Brass (matte) ○ White (matte) ● Grey (matte)

771600	<b>SIS SPOT S D40 24°</b> BLACK	
771601	<b>SIS SPOT S D40 24°</b> WHITE	LED 6,3W 627lm 350mA
771602	<b>SIS SPOT S D40 24°</b> BRASS	2700K CRI≥90 230V
771603	<b>SIS SPOT S D40 24°</b> GREY	
771610	<b>SIS SPOT S D40 36°</b> BLACK	
771611	<b>SIS SPOT S D40 36°</b> WHITE	LED 6,3W 627lm 350mA
771612	<b>SIS SPOT S D40 36°</b> BRASS	2700K CRI≥90 230V
771613	<b>SIS SPOT S D40 36°</b> GREY	
771620	<b>SIS SPOT S D40 60°</b> BLACK	
771621	<b>SIS SPOT S D40 60°</b> WHITE	LED 6,3W 627lm 350mA
771622	<b>SIS SPOT S D40 60°</b> BRASS	2700K CRI≥90 230V
771623	<b>SIS SPOT S D40 60°</b> GREY	

771700	<b>SIS SPOT SR D40 24°</b> BLACK	
771701	<b>SIS SPOT SR D40 24°</b> WHITE	LED 6,3W 627lm 350mA
771702	<b>SIS SPOT SR D40 24°</b> BRASS	2700K CRI≥90 230V
771703	<b>SIS SPOT SR D40 24°</b> GREY	
771710	<b>SIS SPOT SR D40 36°</b> BLACK	
771711	<b>SIS SPOT SR D40 36°</b> WHITE	LED 6,3W 627lm 350mA
771712	<b>SIS SPOT SR D40 36°</b> BRASS	2700K CRI≥90 230V
771713	<b>SIS SPOT SR D40 36°</b> GREY	
771720	<b>SIS SPOT SR D40 60°</b> BLACK	
771721	<b>SIS SPOT SR D40 60°</b> WHITE	LED 6,3W 627lm 350mA
771722	<b>SIS SPOT SR D40 60°</b> BRASS	2700K CRI≥90 230V
771723	<b>SIS SPOT SR D40 60°</b> GREY	

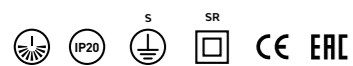

## SIS SPOT S/SR OPAL GLASS DIFFUSER

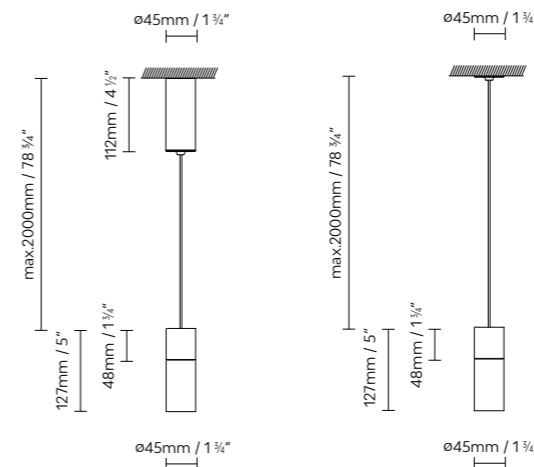

● Black (matte) ● Brass (matte) ○ White (matte) ● Grey (matte)

771670	<b>SIS SPOT S OPAL GLASS DIFFUSER</b> BLACK	
771671	<b>SIS SPOT S OPAL GLASS DIFFUSER</b> WHITE	LED 6,3W 627lm 350mA 2700K
771672	<b>SIS SPOT S OPAL GLASS DIFFUSER</b> BRASS	CRI≥90 230V
771673	<b>SIS SPOT S OPAL GLASS DIFFUSER</b> GREY	
771770	<b>SIS SPOT SR OPAL GLASS DIFFUSER</b> BLACK	
771771	<b>SIS SPOT SR OPAL GLASS DIFFUSER</b> WHITE	LED 6,3W 627lm 350mA 2700K
771772	<b>SIS SPOT SR OPAL GLASS DIFFUSER</b> BRASS	CRI≥90 230V
771773	<b>SIS SPOT SR OPAL GLASS DIFFUSER</b> GREY	

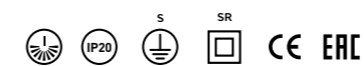

## SIS SPOT GROOVE GLASS DIFFUSER ACCESSORY

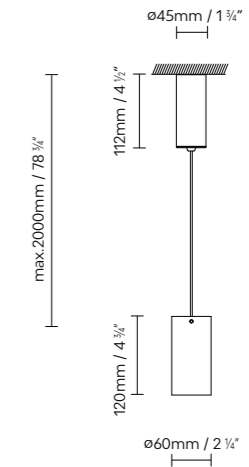

771951	<b>SIS SPOT GROOVE GLASS DIFFUSER ACCESSORY</b>
--------	---



B.lux

# Outdoor lighting





B.lux

# C\_Ball Outdoor

by  
Stone Designs

Outdoor  
lighting

C\_Ball W Outdoor is comprised of an opal glass sphere whose characteristics grant it a high degree of resistance to UVA rays, as well as unbeatable light quality. This outdoor wall light's metal parts are available in different finishes: black, beige, turquoise and corten.

C\_Ball W Outdoor está formada por una esfera de vidrio opal, cuyas características le otorgan un elevado grado de resistencia a los rayos UVA, así como una inmejorable calidad de luz. Las partes metálicas de este aplique de exterior están disponibles en diferentes acabados: negro, beige, turquesa y corten.

C\_Ball W Outdoor besteht aus einer Opalglaskugel mit hoher Beständigkeit gegen UV-Strahlen und unvergleichlicher Lichtqualität. Die Metallteile dieser Wandleuchte für den Außenbereich sind in verschiedenen Ausführungen erhältlich: Schwarz, Beige, Türkis und Cortenstahl.



## C\_BALL W OUTDOOR

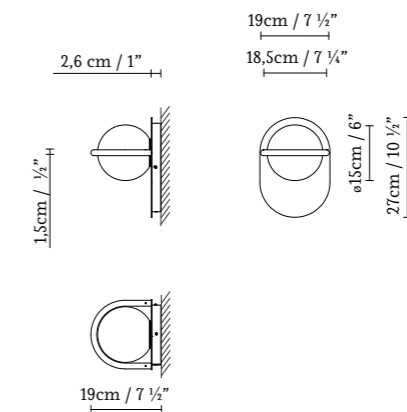

● Black ● Beige ● Clear Turquoise ● Corten

748431 C\_BALL W OUTDOOR CORTEN  
748432 C\_BALL W OUTDOOR BEIGE  
748433 C\_BALL W OUTDOOR CLEAR TURQUOISE LED 6W (E14)  
748435 C\_BALL W OUTDOOR BLACK





**B.lux**

# Sis Outdoor

by María Güell  
& Carrasquet

Outdoor  
lighting

Sis Outdoor is a small outdoor ceiling downlight lamp (IP65). As its driver is built into its light source, it can be installed on any surface. Its solid glass lens guarantees great light quality and comfort with no glare. Finishes: Black, white, corten and bronze. Available in special finishes.

Sis Outdoor es un plafón de reducidas dimensiones downlight de exterior IP65. Al tener su driver integrado en la fuente de luz, permite su instalación en cualquier superficie. Su lente de sólido de cristal asegura una gran calidad de luz y confort lumínico, con ausencia de deslumbramiento. Acabados: Negro, blanco, corten y bronce. Disponible en acabados especiales.

Sis Outdoor ist eine kleine Downlight-Deckenleuchte für den Außenbereich mit Schutzart IP65. Da der Treiber in die Lichtquelle integriert ist, kann sie auf jeder Oberfläche installiert werden. Die solide Glaslinse sorgt für hohe Lichtqualität und Beleuchtungskomfort, ohne zu blenden. Ausführungen: Schwarz, Weiß, Cortenstahl oder Bronze. Erhältlich in Sonderausführungen.



## SIS C OUTDOOR

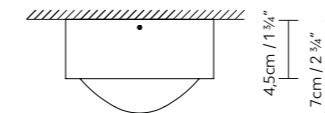
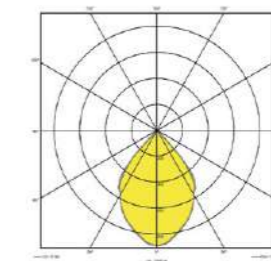
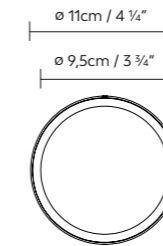

● Black    ○ White    ● Corten    ● Bronze

771400 **SIS C OUTDOOR BLACK**  
771401 **SIS C OUTDOOR WHITE**  
771402 **SIS C OUTDOOR CORTEN**  
771403 **SIS C OUTDOOR BRONZE**

LED 7W 520lm 2700K CRI≥90 230V





**B.lux**

# Soft

by  
**Josep Lluís Xuclà**

**Outdoor  
lighting**

Soft is an outdoor bollard available in two heights (45 and 65 cm) and manufactured in aluminium. It has a reflector and a diffuser with a large aperture to generate a 180° light beam. Finishes: black, olive, beige and corten.

Soft es una baliza de exterior disponible en dos alturas (45 y 65 cm) y fabricada en aluminio. Cuenta con un reflector y difusor de gran apertura que genera un haz de luz de 180°. Acabados: negro, oliva, beige y corten.

Soft ist ein Leuchtpfosten aus Aluminium für den Außenbereich und in zwei Höhen (45 und 65 cm) erhältlich. Er hat einen Reflektor mit großem Öffnungswinkel und einen Diffusor, der einen Lichtstrahl von 180° erzeugt. Ausführungen: Schwarz, Olive, Beige und Cortenstahl.





Soft



SOFT 45

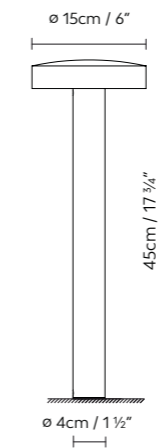

SOFT 65

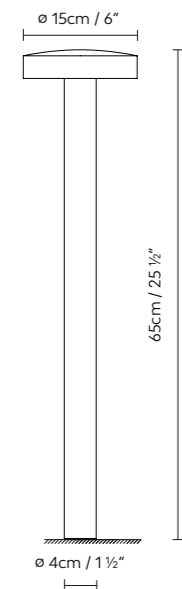

- Black
- Olive
- Beige
- Corten

770240	<b>SOFT 45 BLACK</b>	
770241	<b>SOFT 45 OLIVE</b>	LED 6,4W 640lm 2700K CRI≥90 230V
770242	<b>SOFT 45 BEIGE</b>	DIM PHASE CUT
770243	<b>SOFT 45 CORTEN</b>	

770260	<b>SOFT 65 BLACK</b>	
770261	<b>SOFT 65 OLIVE</b>	LED 6,4W 640lm 2700K CRI≥90 230V
770262	<b>SOFT 65 BEIGE</b>	DIM PHASE CUT
770263	<b>SOFT 65 CORTEN</b>	

770900	<b>SPIKE BLACK</b>
770901	<b>SPIKE OLIVE</b>
770902	<b>SPIKE BEIGE</b>
744902	<b>SPIKE CORTEN</b>





**B.lux**

# Soft W

by  
**Josep Lluís Xuclà**

**Outdoor  
lighting**

Soft W is a wall outdoor lamp available in two versions: WH with indirect lighting that washes the wall, and WV with direct lighting, an opal diffuser and an angle of aperture of 180°. Finishes: black, olive, beige and corten.

Soft W es un aplique de exterior disponible en dos versiones: WH de luz indirecta bañando la pared y WV de luz directa con difusor opalino y un ángulo de apertura de 180°. Acabados: negro, oliva, beige y corten.

Soft W ist eine Wandleuchte für den Außenbereich und in zwei Versionen erhältlich: WH mit indirektem Licht als Wandfluter und WV mit direktem Licht, opalinem Diffusor und einem Öffnungswinkel von 180°. Ausführungen: Schwarz, Olive, Beige und Cortenstahl.

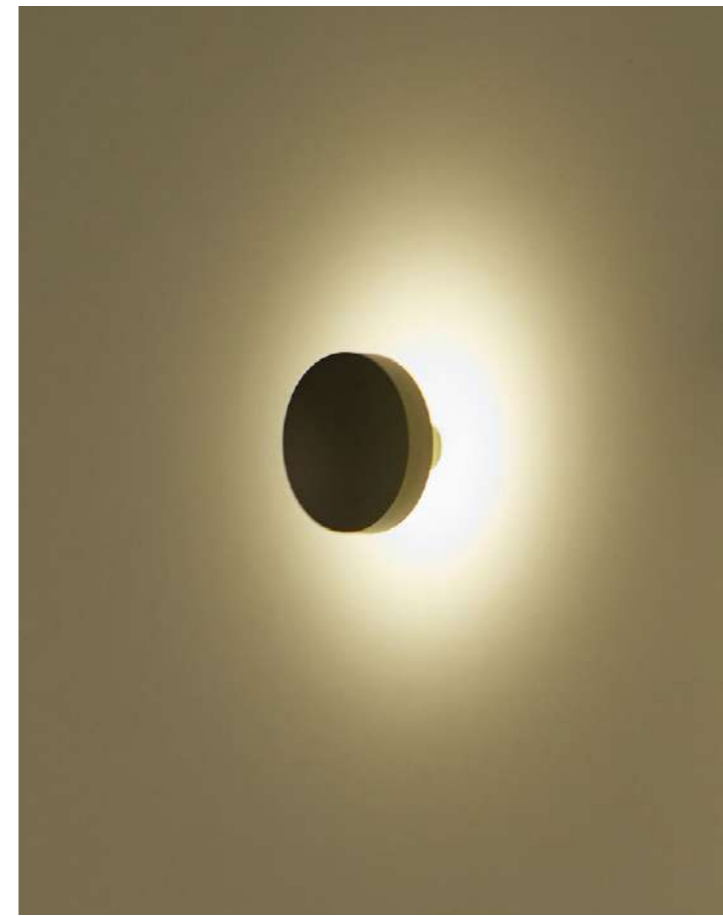

**SOFT WH**

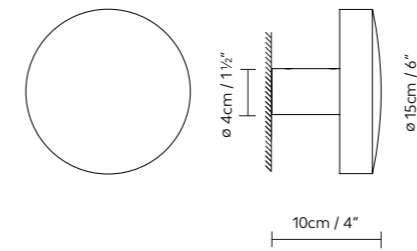

**SOFT WV**

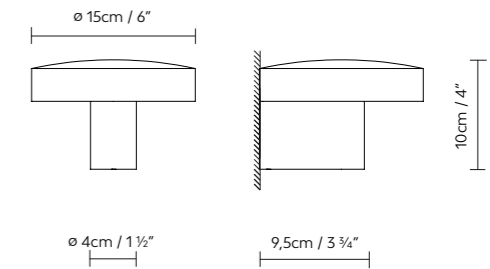

● Black ● Olive ● Beige ● Corten

770100 **SOFT WH BLACK**  
770101 **SOFT WH OLIVE**  
770102 **SOFT WH BEIGE**  
770103 **SOFT WH CORTEN** LED 6,4W 640lm 2700K CRI≥90 230V DIM PHASE CUT

770150 **SOFT WV BLACK**  
770151 **SOFT WV OLIVE**  
770152 **SOFT WV BEIGE**  
770153 **SOFT WV CORTEN** LED 6,4W 640lm 2700K CRI≥90 230V DIM PHASE CUT



B.lux

# Tube W

by  
Josep Lluís Xuclà

Outdoor  
lighting

Outdoor wall light featuring a rotating LED head. Its wedge-shaped base adjusts the beam of light based on its orientation. Available in olive, corten, black or white finishes.

Aplique de exterior con cabeza lumínica LED giratoria. Su base en forma de cuña genera haces de luz más abiertos o cerrados en rigor a su orientación. Disponible en acabados oliva, corten, negro o blanco.

Wandleuchte für den Außenbereich mit drehbarem LED-Leuchtenkopf. Ihre keilförmige Basis erzeugt je nach Ausrichtung breitere oder schmalere Lichtstrahlen. Erhältlich in den Farben Olive, Cortenstahl, Schwarz oder Weiß.

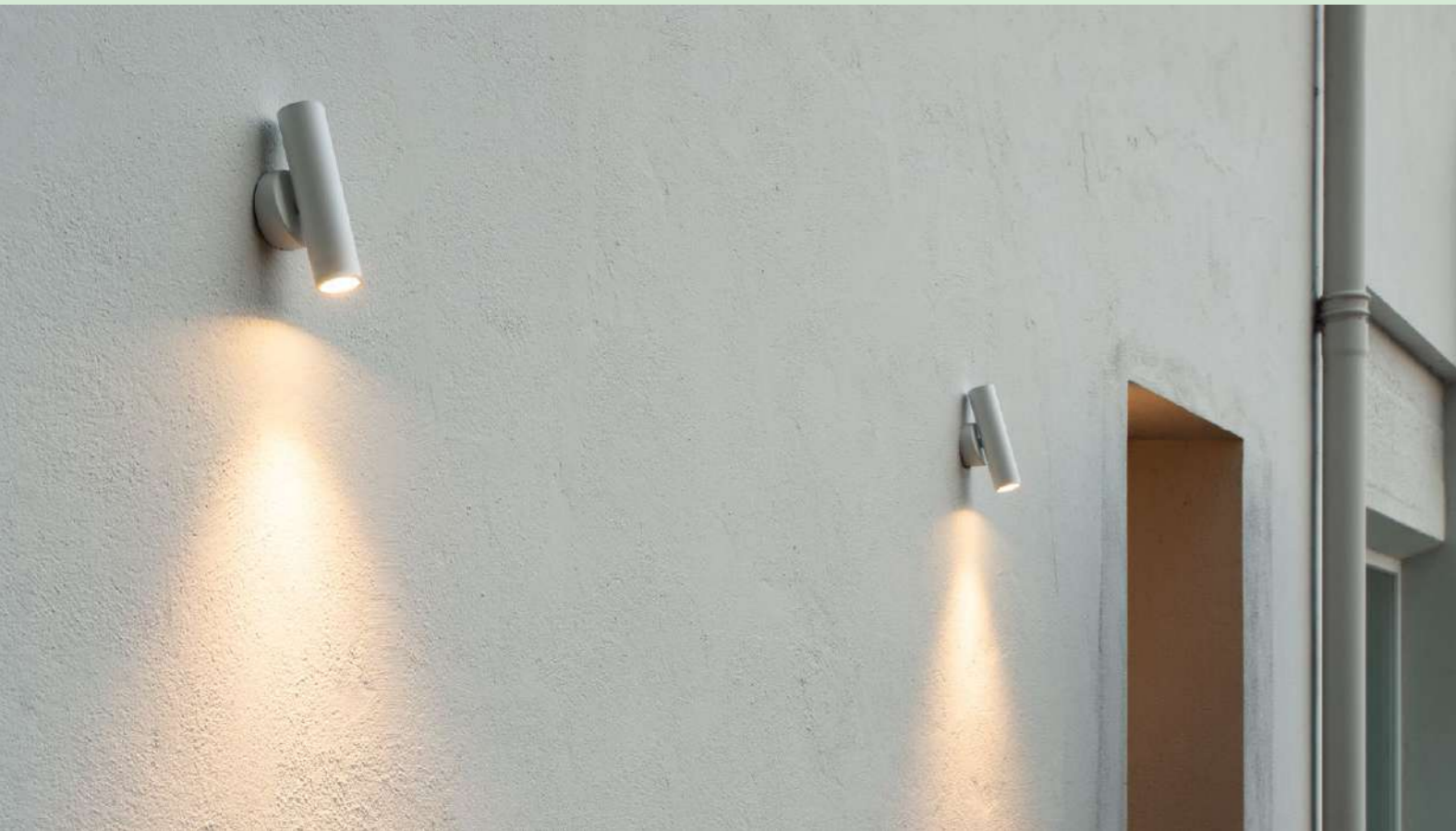

## TUBE W

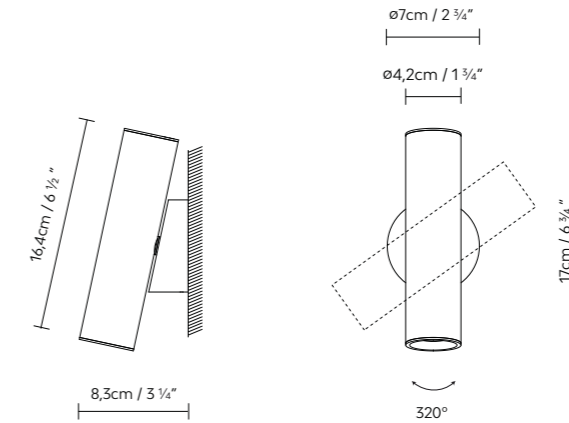

● Olive ● Corten ● Black ○ White

744101 **TUBE W OLIVE**  
744102 **TUBE W CORTEN**  
744103 **TUBE W BLACK**  
744104 **TUBE W WHITE**

LED 4,5W 546lm 250mA 3000K CRI≥90 230V





**B.lux**

# Zenthin

by Martínez  
y Soler Arquitectos

Outdoor  
lighting

Outdoor LED floor lamp available with one (1L) or two lights (2L). Made in corten aluminum, and clad in ipe wooden panels on two sides. Zenthin has a fully embedded LED light source for a completely anti-glare lighting. Optional: painted finish without wood.

Luminaria de pie LED de exterior con una (1L) o dos luces (2L). Está fabricada en aluminio con acabado corten, y recubierta en dos de sus caras por láminas de madera natural de ipe. Zenthin porta una fuente de luz LED completamente integrada, lo que garantiza una ausencia total de deslumbramiento. Opcional: acabado pintado sin madera.

LED-Steheuchte für den Außenbereich, verfügbar mit einer 1L und zwei 2L Leuchten. Sie werden aus Aluminium mit einem Finish aus Corten-Stahl hergestellt, und zwei Seiten mit naturbelassenem Holz des afrikanischen Pflaumenbaums beschichtet. Zenthin ist mit einer komplett eingebauten LED-Lichtquelle ausgestattet, die jede Blendung ausschließt. Optional: Finish, gestrichen ohne Holz.



Zenthin



ZENTHIN 1

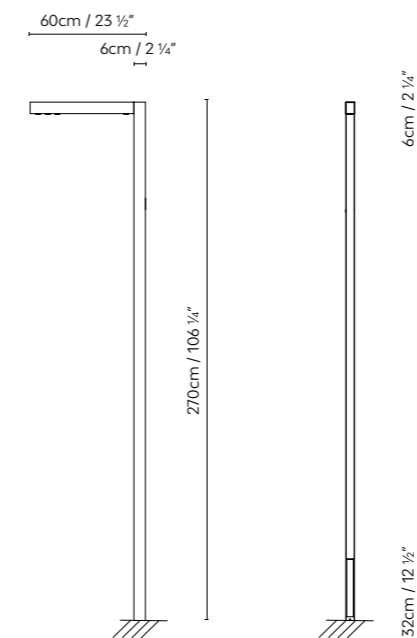

ZENTHIN 2

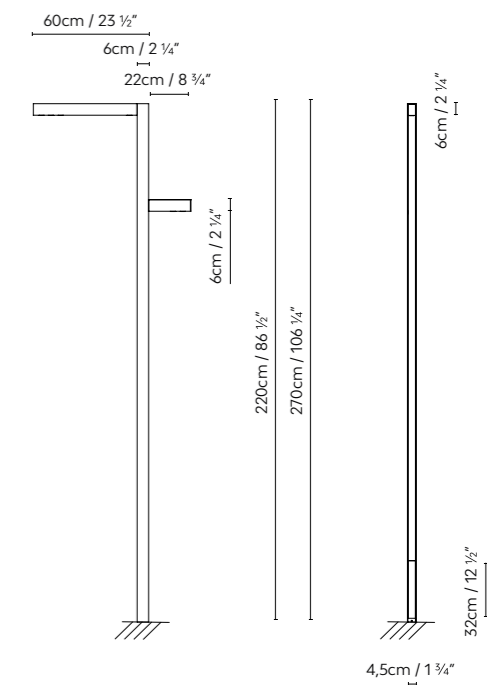

● Corten / wood

759201	<b>ZENTHIN 1</b>	LED 4 x 6,4W 350mA 3040lm 3000K CRI≥90 230V
759202	<b>ZENTHIN 2</b>	LED 4 x 6,4W 350mA 3040lm 3000K CRI≥90 230V + LED 2 x 6,4W 350mA 1520lm 3000K CRI≥90 230V
678910	<b>ZENTHIN: SET OF BOLT FIXTURES</b>	





**B.lux**

# Zenthin W

by Martínez  
y Soler Arquitectos

Outdoor  
lighting

Outdoor LED wall lamp. Made in corten aluminum and clad in ipe wooden panels on two sides. Zenthin has a fully embedded LED light source for a completely anti-glare lighting. Optional: painted finish without wood.

Aplique LED de exterior. Está fabricado en aluminio con acabado corten, y recubierta en dos de sus caras por láminas de madera natural de ipe. Zenthin porta una fuente de luz LED completamente integrada, lo que garantiza una ausencia total de deslumbramiento. Opcional: acabado pintado sin madera.

LED-Wandleuchte für den Außenbereich. Sie werden aus Aluminium mit einem Finish aus Corten-Stahl hergestellt, und zwei Seiten mit naturbelassenem Holz des afrikanischen Pflaumenbaums beschichtet. Zenthin ist mit einer komplett eingebauten LED-Lichtquelle ausgestattet, die jede Blendung ausschließt. Optional: Finish, gestrichen ohne Holz.



## ZENTHIN W

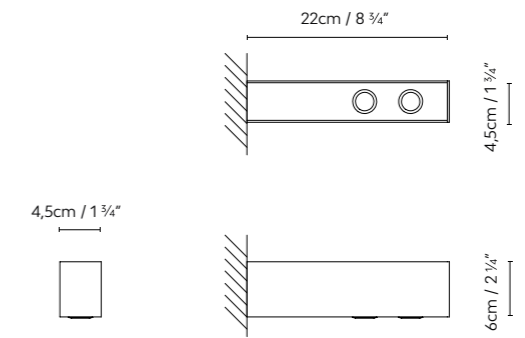

● Corten / wood







759100















ZENTHIN W

LED 2 x 6,4W 350mA 1520lm 3000K CRI≥90 230V



# Iconography

- |  |   |  |
|--|---|--|
|  Suspension lamp<br>Luminaria de suspensión<br>Hängeleuchte |  Floor lamp<br>Luminaria de pie<br>Stehleuchte       |  Table lamp<br>Luminaria de mesa<br>Tischleuchte                    |
|  Wall lamp<br>Luminaria de pared<br>Wandleuchte             |  Ceiling lamp<br>Luminaria de techo<br>Deckenleuchte |  Lighting systems<br>Sistemas de iluminación<br>Beleuchtungssysteme |

- |   |   |   |
|---|---|---|
|  Degree of protection 20 |  Degree of protection 44 |  Degree of protection 54                               |
|  Degree of protection 55 |  Degree of protection 65 |  Programme for the Endorsement of Forest Certification |
|  Class I                 |  Class II                |  Class III   |
|  European norm           |  EAC certification       |  ENEC certification                                    |
|  N certification         |  Dimmer                  |  Bluetooth<br><small>REQUEST</small>                   |

**B.LUX S.A.**

Pol. Ind. Okamika, pab. 1  
Gizaburuaga (Bizkaia) SPAIN  
T.(+34) 94 682 72 72  
F.(+34) 94 682 49 02  
info@grupoblux.com  
www.bluxlighting.com



DEPÓSITO LEGAL

B.lux S.A. reserves the right to make any modifications and remove products and their technical characteristics without prior notice.  
B.lux S.A. se reserva el derecho de efectuar cualquier modificación y anulación de los productos y sus características técnicas, sin previo aviso.  
B.lux S.A. behalte sich das Recht vor, Produkte bzw. Deren technische Eigenschaften ohne vorherige Ankündigung abzuändern oder zu streichen.

Acknowledgments and Project references:

**ILMIO Design**

Hotel Canfranc, Canfranc (Spain)  
www.ilmio.design  
Page 18

**Stone Designs**

Revival Cafe, Madrid (Spain)  
www.stone-dsgns.com  
Page 232

**OOAA Arquitectura**

Architecture Studio, Madrid (Spain)  
www.oaaa.es  
Page 260

**Studio Libeskind**

MO Museum, Vilnius (Lithuania)  
www.libeskind.com  
Page 334



**CASAMBI** B.lux powered by Casambi App

The Casambi app works as one of the user interfaces in a Casambi lighting control solution, as the commissioning tool and as well as a remote gateway. The Casambi app works with iOS as well as Android devices, like smartphones, tablets and smartwatches. The app is free to download by any end-user.  
The Casambi app is made by user interface experts and in a way, that anyone – regardless of technical proficiency – can use it. The Casambi lighting control technology gives a possibility for Casambi’s partners to implement and develop anything needed for a full-featured lighting control system, but the Casambi app only shows in the user interface the functionality that is relevant to that particular installation. Therefore, the Casambi app is equally well suitable for the professional lighting market as well as the residential field.



**B.lux**

**[bluxlighting.com](http://bluxlighting.com)**