

DIBUJOS TÉCNICOS · TECHNICAL DRAWINGS

REF. 637-P50x50

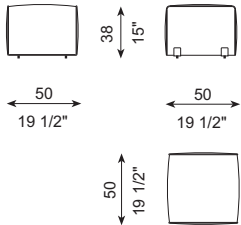

REF. 637-P50x100

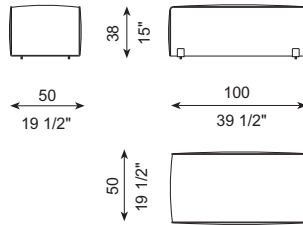

REF. 637-P50x120

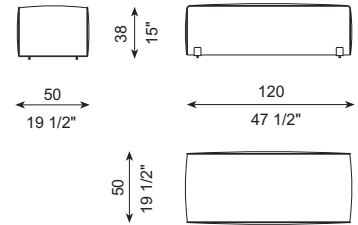

REF. 637-P50x140

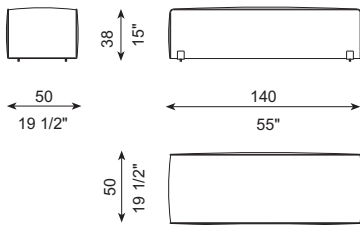

REF. 637-P50x160

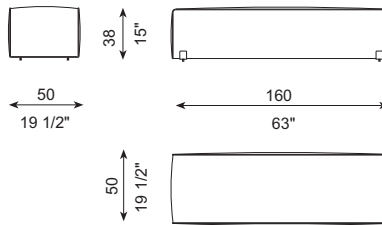

REF. 637-P80x80

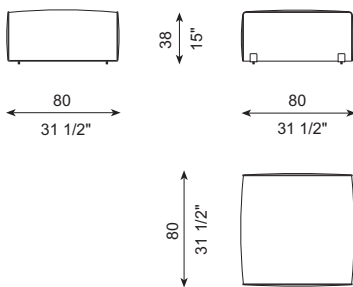

REF. 637-PI00x100

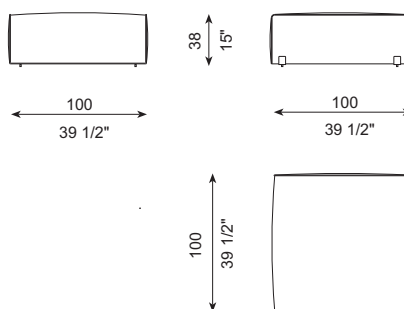

ESPECIFICACIONES · SPECIFICATIONS

Pufés realizados en estructura de madera recubierta de espuma de poliuretano de diversas densidades y capa de fibra de poliéster. Tapizados en tejido protector y tejido final desenfundable mediante velcros. Pies en hierro acabado según muestrario.

Structure in wood, covered with polyurethane foam with different densities and layer of polyester fiber. Recovered with a protective fabric and removable cover with Velcro's. Feet in iron (finish as per our catalogue).

Gestell aus Holz, bezogen mit verdichtetem Polyurethanschaum und Polyesterfaserauflage. Mit Schonbezug. Abziehbarer Bezug mit Klettverschluss. Füße aus Eisen (Finish laut Katalog).

Structure en bois, recouverte de mousse de polyuréthane avec différents densités et couche de fibre de polyester. Dispose d'un tissu de protection. La housse avec velcros est amovible. Pieds en fer (finition selon catalogue).

DIBUJOS TÉCNICOS · TECHNICAL DRAWINGS

REF. 639-P50x50

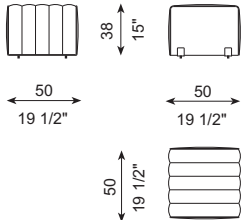

REF. 639-P50x100

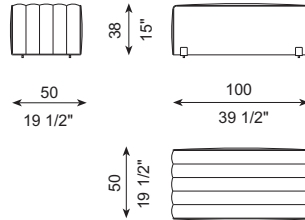

REF. 637-P50x120

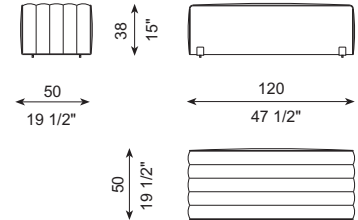

REF. 639-P50x140

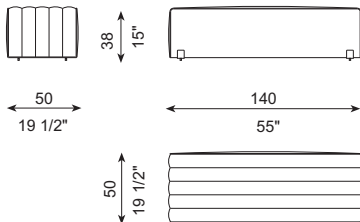

REF. 639-P50x160

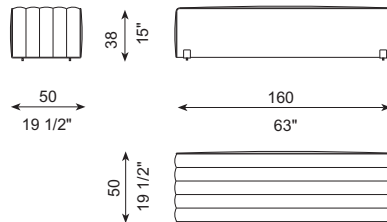

REF. 639-P80x80

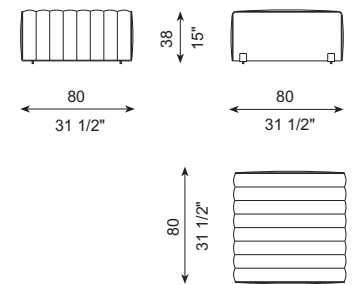

ESPECIFICACIONES · SPECIFICATIONS

Pufés realizados en estructura de madera recubierta de espuma de poliuretano de diversas densidades y capa de fibra de poliéster. Tapizados en tejido protector y tejido final desenfundable mediante velcros. Pies en hierro acabado según muestrario.

Structure in wood, covered with polyurethane foam with different densities and layer of polyester fiber. Recovered with a protective fabric and removable cover with Velcro's. Feet in iron (finish as per our catalogue).

Gestell aus Holz, bezogen mit verdichtetem Polyurethanschaum und Polyesterfaserauflage. Mit Schonbezug. Abziehbarer Bezug mit Klettverschluss. Füße aus Eisen (Finish laut Katalog).

Structure en bois, recouverte de mousse de polyuréthane avec différents densités et couche de fibre de polyester. Dispose d'un tissu de protection. La housse avec velcros est amovible. Pieds en fer (finition selon catalogue).