

3259

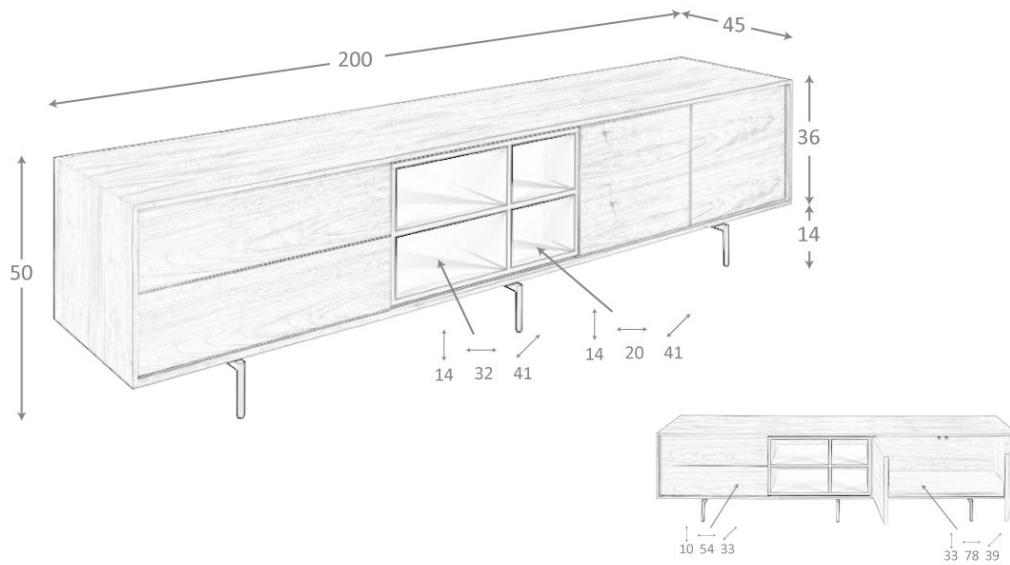

200 x 45 x 50 cm
70 Kg
0,56 m³

 205 x 50 x 55 cm

 72 Kg

