DELTA SOFÁ

By Jorge Pensi

Delta collection is made to fit in with exterior or interior contemporary spaces. The injected aluminum base and extracted aluminum column make it ideal for use in the open air, due to the weather-resistant properties of these materials. The folding top and the design of the base enables the tables to be lined up one against the other to save space when they are not in use. The goal of the DELTA chair was to create a timeless product that constantly seeks to strike a balance between realism and surrealism— matter and antimatter, abstraction and emotion. The goal was to maximize emotions while minimizing resources, questioning the common logic of something new.

SECTIONS

11.69 Kg

VONDOM®

50.11 Kg

204 - 80¼"

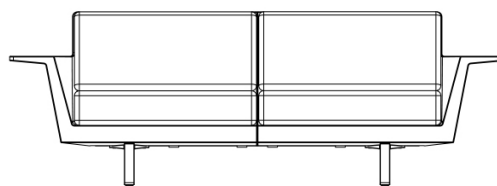
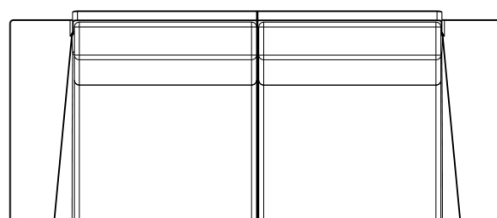
72
28¼"88
34¾"

DELTA Sofá Modular 2 plazas
DELTA Sectinal Sofa 2 seats

71.25 Kg

280 - 110¼"

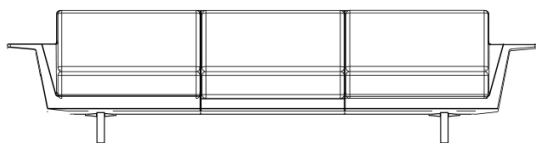
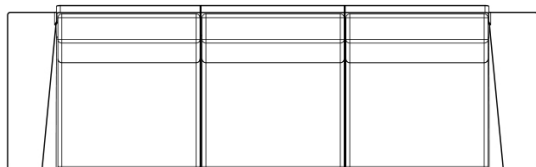
72
28¼"88
34¾"

DELTA Sofá Modular 3 plazas
DELTA Sectinal Sofa 3 seats

105.06 Kg

356 - 140¼"

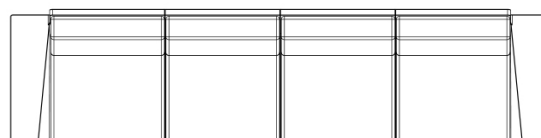
72
28¼"88
34¾"

DELTA Sofá Modular 4 plazas
DELTA Sectinal Sofa 4 seats

118.26 Kg

432 - 170"

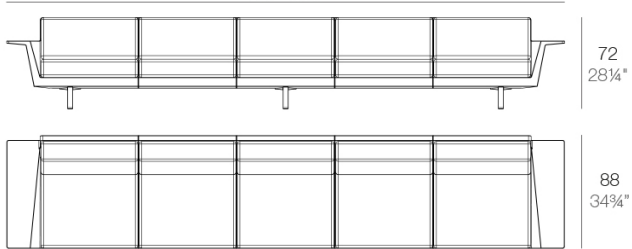

DELTA Sofá Modular 5 plazas
DELTA Sectinal Sofa 5 seats

62.17 Kg

280 - 110 1/4"

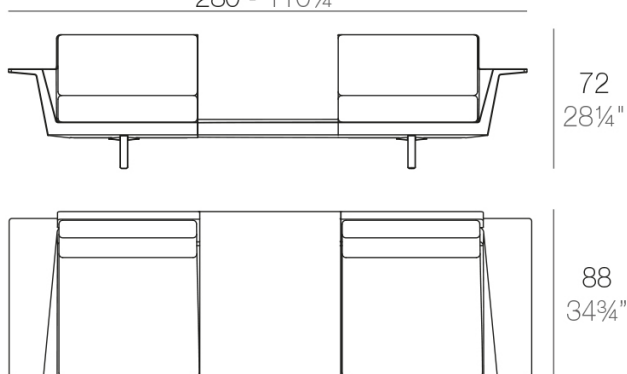

DELTA Sofá 2 plazas + mesa
DELTA Sofa 2 seats + table

109.18 Kg

432 - 170"

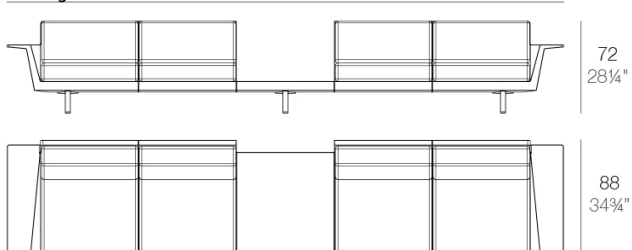

DELTA Sofá 4 plazas + mesa
DELTA Sofa 4 seats + table

97.36 Kg

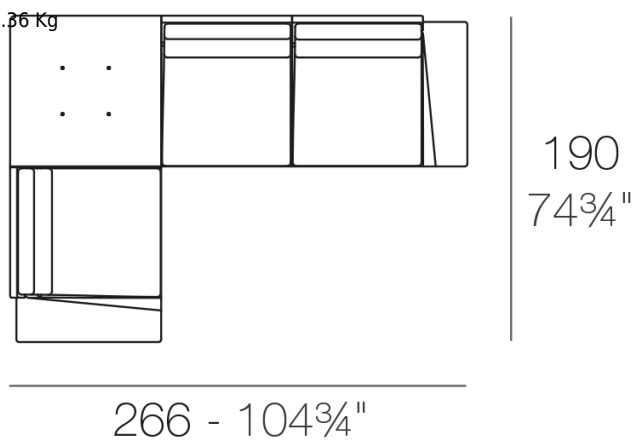

DELTA Sofá 3 plazas - Derecho
DELTA Sofa 3 seats - Right

93.97 Kg

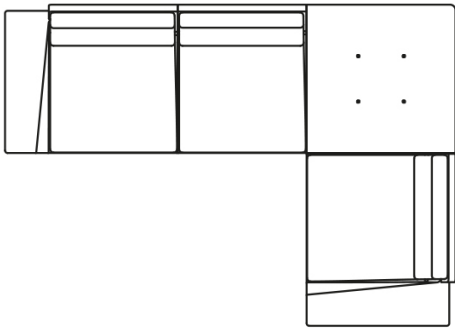
190
74³/₄"266 - 104³/₄"

DELTA Sofá 3 plazas - Izquierdo
DELTA Sofa 3 seats - Left

115.17 Kg

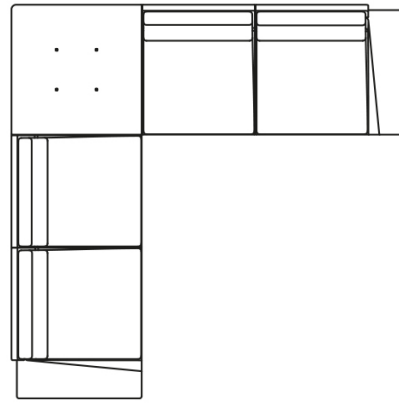
266
104³/₄"266 - 104³/₄"

DELTA Sofá 4 plazas
DELTA Sofa 4 seats

115.02 Kg

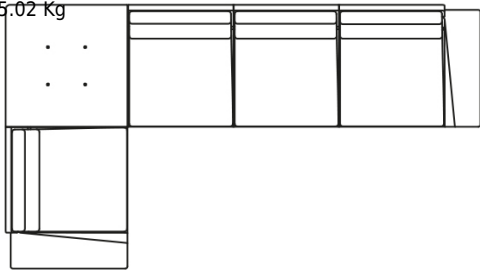
190
74³/₄"342 - 134³/₄"

DELTA Sofá 4 plazas - Derecho
DELTA Sofa 4 seats - Right

115.02 Kg

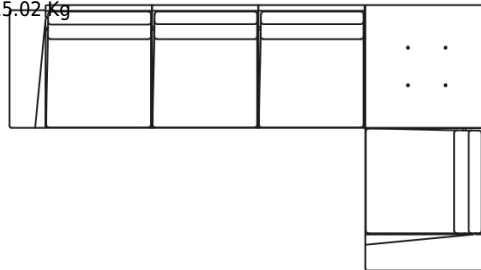
190
74³/₄"342 - 134³/₄"

DELTA Sofá 4 plazas - Izquierdo
DELTA Sofa 4 seats - Left

136.22 Kg

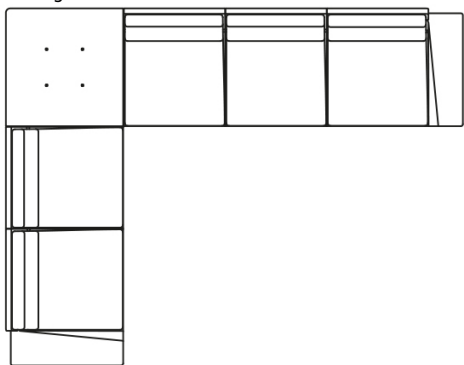

266
104 $\frac{3}{4}$ "

342 - 134 $\frac{3}{4}$ "

DELTA Sofá 5 plazas - Derecho
DELTA Sofa 5 seats - Right

50.11 Kg



266
104 $\frac{3}{4}$ "

342 - 134 $\frac{3}{4}$ "

DELTA Sofá 5 plazas - Izquierdo
DELTA Sofa 5 seats - Left