

viccarbe

Maarten Table

Designed by Victor Carrasco

Technical info - EN

V01

HEIGHT 74 | 29⁹/₆₄

MAA80_
table 80x80 | 31¹/₂ x 31¹/₂

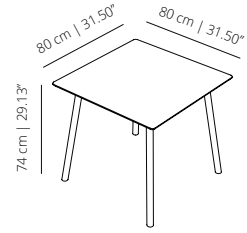

HEIGHT 74 | 29⁹/₆₄

MAA160_
table 160x90 | 35⁷/₁₆ x 62⁶³/₆₄

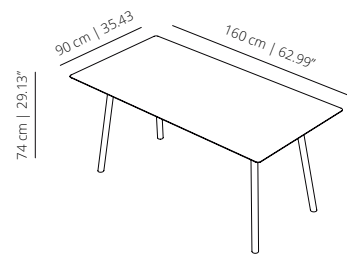

HEIGHT 74 | 29⁹/₆₄

MAA180_
table 180x90 | 35⁷/₁₆ x 62⁶³/₆₄

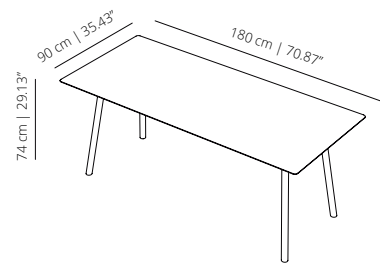

HEIGHT 74 | 29⁹/₆₄

MAA200_
table 200x90 | 35⁷/₁₆ x 78⁴⁷/₆₄

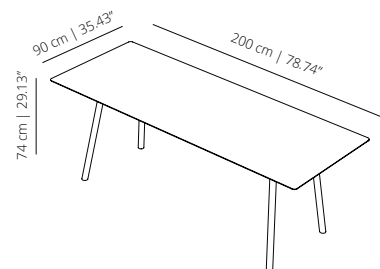

MAA160_
table 160x80 | 31¹/₂ x 62⁶³/₆₄

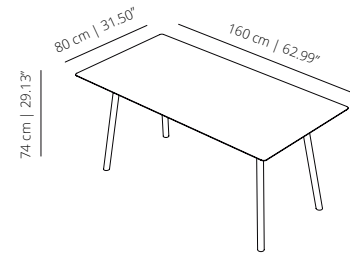

MAA180_
table 180x80 | 70⁵⁵/₆₄ x 31¹/₂

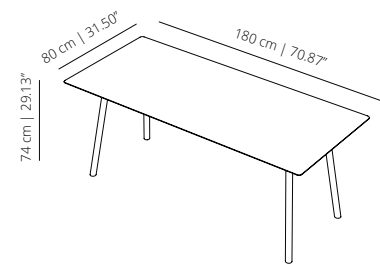

MAA200_
table 200x80 | 31¹/₂ x 78⁴⁷/₆₄

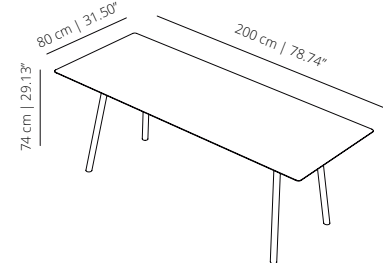

MAAD120_
table 120 | 47¹/₄

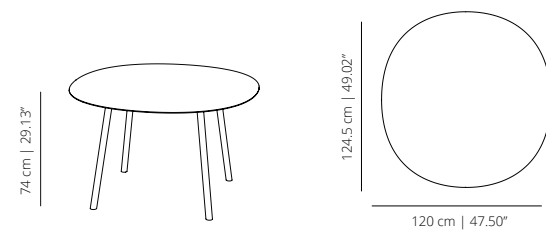

HEIGHT 74 | 29⁹/₆₄

MAAD160_
table 160 | 62⁶³/₆₄

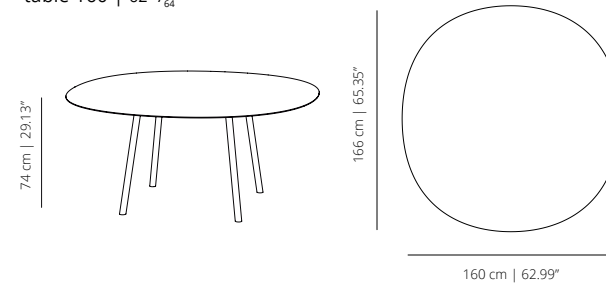

HEIGHT 74 | 29⁹/₆₄

MAA80_
table 80x80 | 31¹/₂ x 31¹/₂ with casters

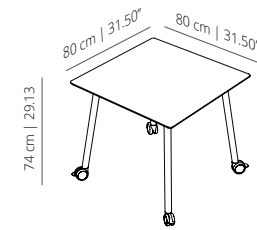

HEIGHT 74 | 29⁹/₆₄

MAA160_
table 160x90 | 35⁷/₁₆ x 62⁶³/₆₄ with casters

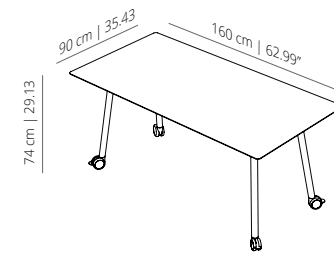

HEIGHT 74 | 29⁹/₆₄

MAA180_
table 180x90 | 35⁷/₁₆ x 62⁶³/₆₄ with casters

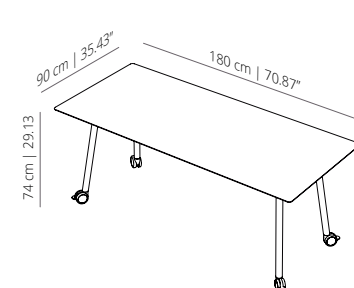

MAAA180_
table 180x80 | 70⁵⁵/₆₄ x 31¹/₂ return table

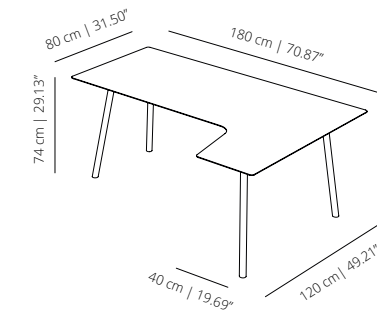

MAA160_
table 160x80 | 31¹/₂ x 62⁶³/₆₄ with casters

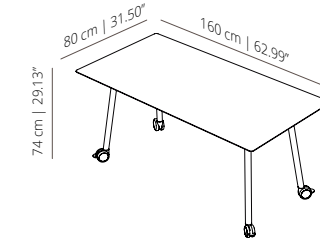

MAA180_
table 180x80 | 70⁵⁵/₆₄ x 31¹/₂ with casters

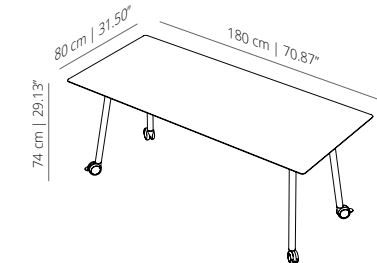

MAA200_
table 200x80 | 31¹/₂ x 78⁴⁷/₆₄ with casters

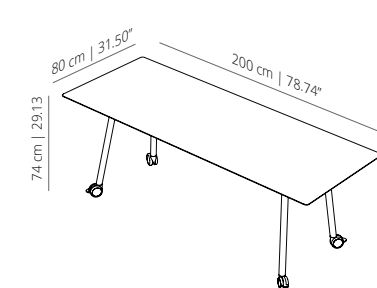

HEIGHT 74 | 29¹/₁₆

MAA200
table 200x90 | 35⁷/₁₆ x 78⁴⁷/₆₄ with casters

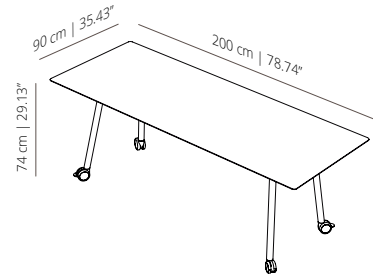

MAAD120
table 120 | 47¹/₄ with casters

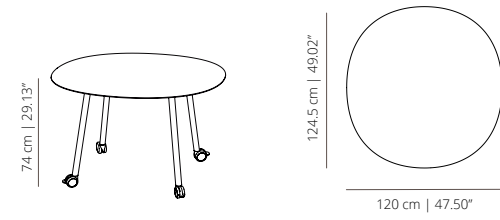

MAAD160
table 160 | 62⁶³/₆₄ with casters

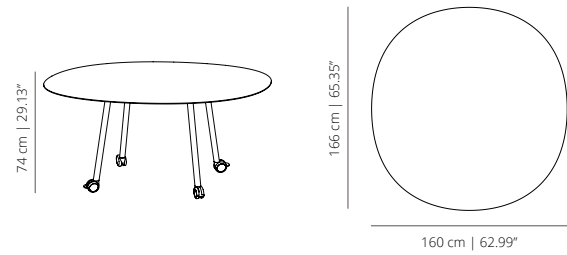

MAAA180
table 180x80 | 70⁵⁵/₆₄ x 31¹/₂ return table with casters

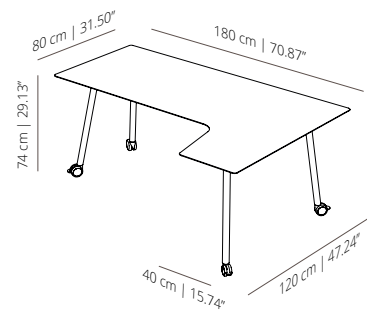

NOTE: Due to the fact that the wood used is natural, the finish may vary.

Legs adjustable in height:

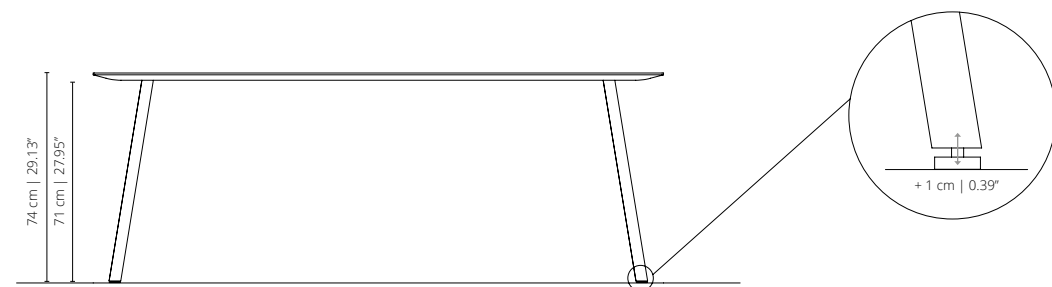

SEATING CAPACITY

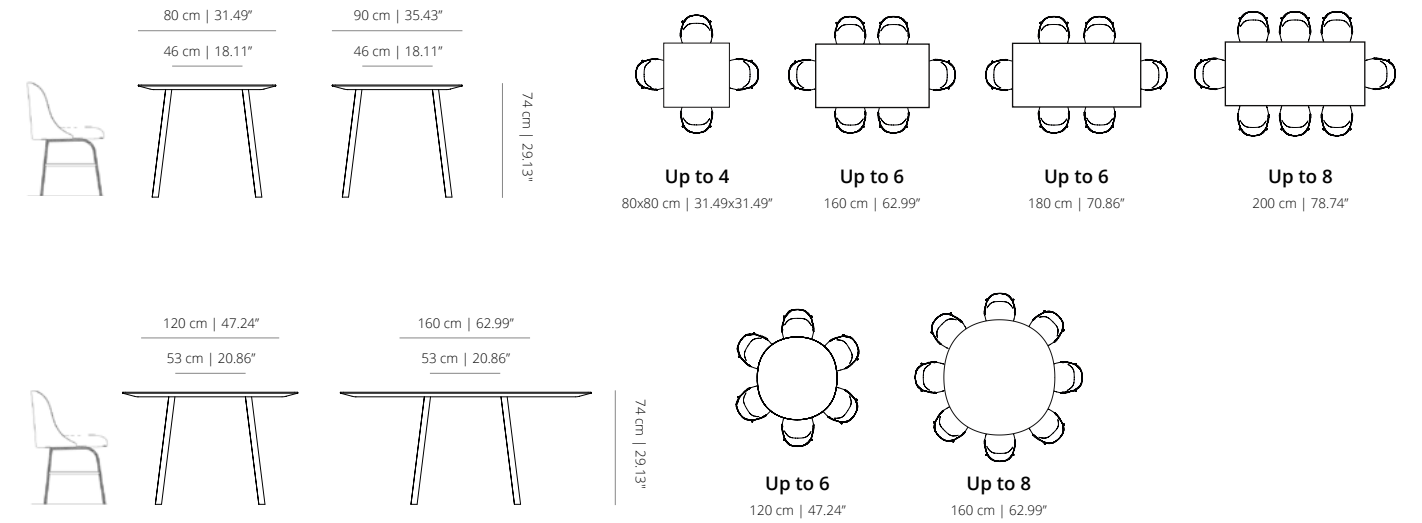

**Seats calculated using Aleta chair, might differ when choosing other models*

LEG OPTIONS



Stained solid wood / metal legs - In heights of 30 or 74 cm, made from calibrated steel, powder coated in thermoreinforced polyester. Available in white, black, fluorescent orange or a stained oak veneer with the finishes of our collection.

Wire management - The Maarten table allows the possibility to manage the wiring so that it is hidden and integrated into the table. For this purpose, the cable management leg (MAAPMER) is available as an option. The leg allows up to 4 cables to be routed inside the table down to the floor.

Casters with brakes - Only for table height 74 cm

TABLETOPS MATERIALS

MDF - STAINED & LACQUERED

The 30 mm thick cover or work surface is made with microtextured MDF. It is lacquered with one of our collection's finishes. It also comes with a solid oak veneer, stained in mate, cognac or ash.

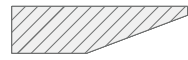

30 mm 1 1.18"

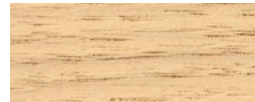

bleached stained oak

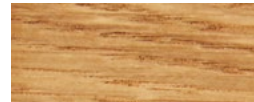

matt stained oak



cognac stained oak



walnut stained oak

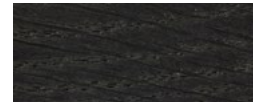

ash stained oak



white
RAL 9003



black
RAL 9005



taupe
RAL 1019



ochre
RAL 1011



dusty green
RAL 7034



olive green
RAL 0904030



brick
RAL 0505030



dusty pink
RAL 0607020

HPL WITH MDF

High pressure HPL laminate in black or white on a 30 mm thick MDF board with stained edges in transparent.

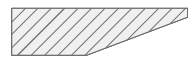

30 mm 1 1.18"



black | soft touch by FENIX®

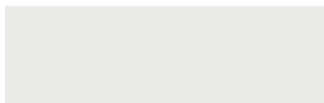

white

ACCESSORIES & ELECTRIFICATIONS



Cut out. Table top custom cut out.



Table top hatch. Metallic hatch access to the lower part of the table. Available in white, black or grey. Does not include power options. Dimensions: 32x15 cm | 12.59"x5.90".



Table top hatch plus. Metallic hatch access to the lower part of the table for wooden table tops. Metal frame available in black or grey and central part in the veneer of the finish of the table. Does not include power options. Dimensions: 32x15 cm | 12.59"x5.90"



Table top powerbox. Metallic hatch for wooden table tops with 4 sockets or combined with built-in multimedia devices. Metal frame available in black or grey and central part in the veneer of the finish of the table. Dimensions: 32x15 cm | 12.59"x5.90"



Table top powerbox plus. Metallic hatch with 4 sockets or combined with built-in multimedia devices. Available in white, black or grey. Dimensions: 32x15 cm | 12.59"x5.90"



USB port. Built-in USB hub for charging electronic devices. Available in black or white. Dimensions: Ø 3 cm | 1.18"



Under table powerbox. Powerbox available with 2 sockets or combined with built-in multimedia devices.



USB hub with battery. USB hub with two USB device charging ports without being plugged into electric current. It's needed to buy the battery charging tray to charge the USB hub battery.



Table top protector in eco leather. Dimension: 44x90 cm | 17.3"x35.4"



Battery charging tray. Charges up to 4 stations simultaneously in 7 hours. Includes magnetic key to remove the station from its support.

