



KENETH COBONPUE

The vast expanse of nature
The lightness of being
The cycle of different seasons
Familiarity of elements
Remembrances of our past
Memories that shape our humanity
Connection with people and culture

Our sense of being open and modest
is to see the beauty that surrounds us
To give love
To live life

Emotions evoke our boundless imagination
Forever evolving, constantly changing
I hope to share all these emotions
through the designs I create

This is my world.
Welcome to KENNETHCOBONPUE

Kenneth Cobonpue

Inspired by nature. Crafted by hand.



CORDA

A single cord moving through air, captured in a moment of stillness, becomes the Corda dining table. This functional piece, crafted from random shapes and loops, is a work of art composed of a mesmerizing pattern of knots and twists.

Natural cotton cord is wrapped around a molded steel frame, carefully arranged to create flowing symmetry, giving this table an intricate appeal that invites you to wander across its surface.

Find yourself tracing the lines and loops with your eyes as you marvel at the beauty of its unique form.

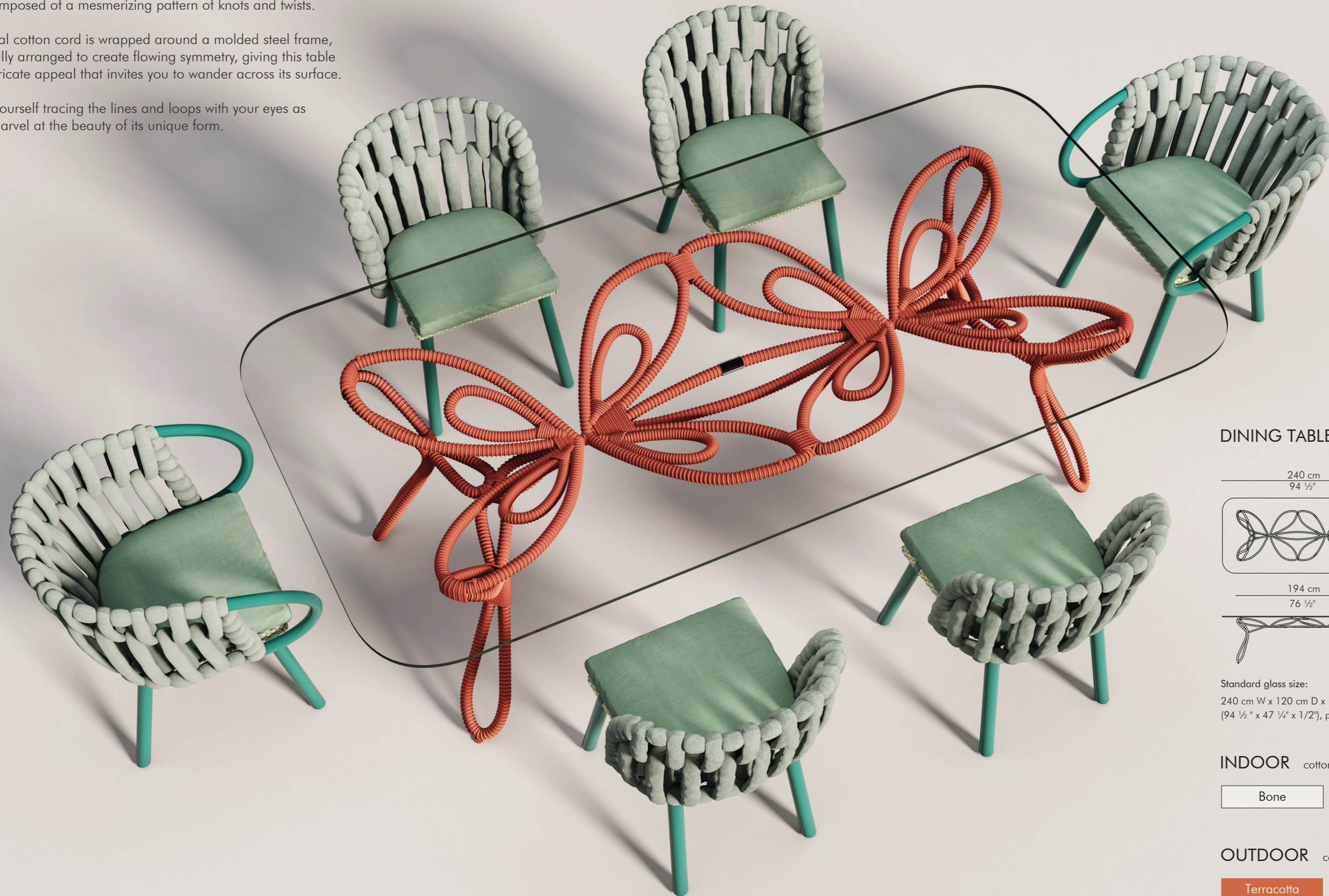

DINING TABLE, rectangular

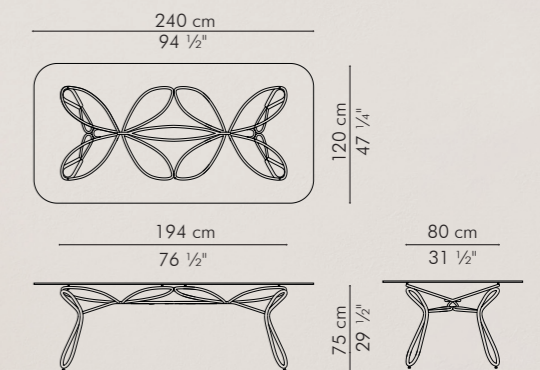

Standard glass size:
240 cm W x 120 cm D x 12 mm thickness
(94 1/2" x 47 1/4" x 1/2"), pencil edge

INDOOR cotton rope, resin, steel

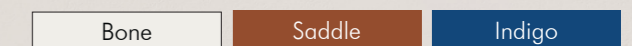

OUTDOOR cotton rope, resin, aluminum

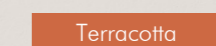



ETRÉ

The visual poetry of square knots—our Etré collection fuses geometric shapes with polygon figures to translate the art and beauty of a knotting craft. An elaborately handmade collection, artisanal hands intricately wrap white fiber strips onto a sinuous steel frame. Plush, gray cotton ropes are then skillfully tied in alternating square knots to create dynamic patterns.

Our “Etré” collection—a visual delight that offers both artistic appeal and soft comfort of upholstered fabrics.

EASYCHAIR

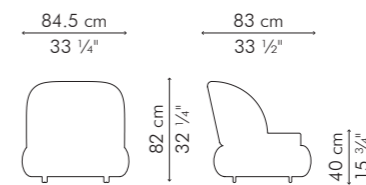

SOFA

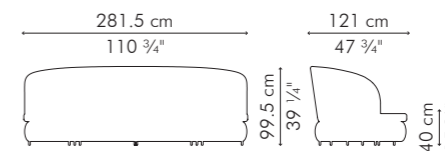

INDOOR foam, fabric, nylon, powdercoated steel



Pink Rose



Graphite Grey



Evergreen

OUTDOOR foam, fabric, polyethylene, aluminum



Ocean Blue



Cappuccino



KNIT

Like a knitted cardigan—warm, cozy, and ever-comforting. Take a rest and be wrapped in the snug embrace of our Knit outdoor collection. Soft and plush fabric tubes filled with polyester fiber are woven over an aluminum frame. Pleasantly laid-back, these woven classic chairs reflect our never-ending love for Nordic craftsmanship and needlework.





EASY ARMCHAIR, outdoor

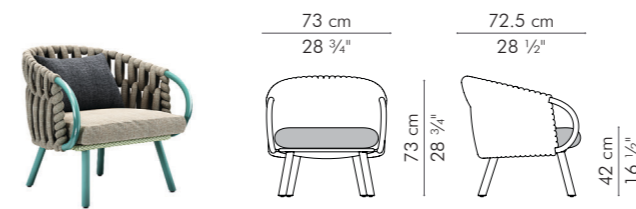

ARMCHAIR, outdoor

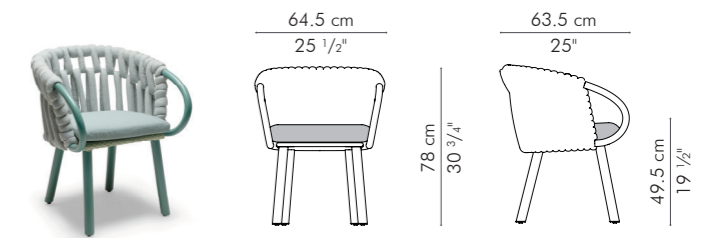

SIDE CHAIR, outdoor

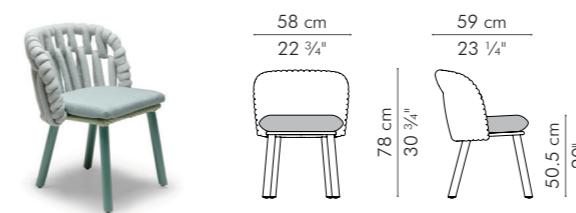

BARSTOOL, outdoor

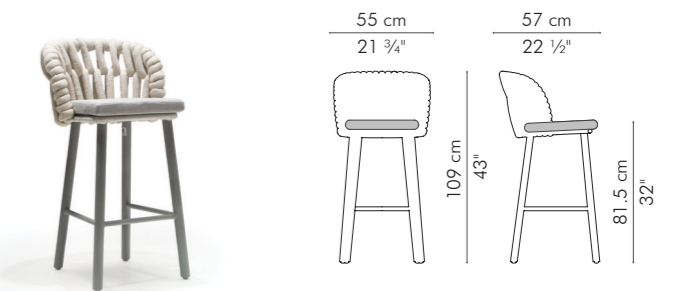

OUTDOOR fabric, polyethylene, aluminum



BAR TABLE, outdoor



OUTDOOR wood, metal





KODO

Kodo in Japanese means "heartbeat." Crafted in the form of a barrel-shaped drum, rattan strips are elaborately bent to flow in vibrating rhythmic patterns of a beating heart. Our "Kodo" collection is a display of sound motions produced from cadence of pulsating beats that composes the melodic symphony of our existence.

END TABLE

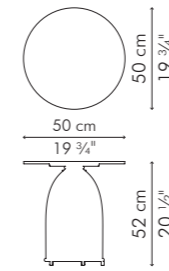

COFFEE TABLE

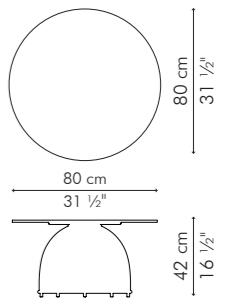

INDOOR rattan, stone cast, steel



OUTDOOR polyethylene, stone cast, steel

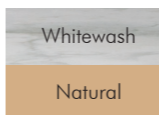



LLAMA

The dependable companion of travelers. Our Llama bar cabinet is made of rattan spokes woven on a metal frame. It features a finely sanded wooden table top and shelf, and two compartments that open on each side. Its upholstered canopy, adorned with dangling tassels, is crafted with built-in wine glass holders.

BAR CABINET

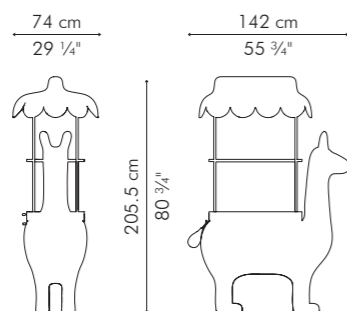

INDOOR rattan, steel, wood, fabric

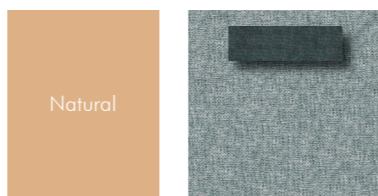



SPIN

Carbon fiber is one of the strongest and lightest materials on earth. I wanted to create a chair unparalleled in its lightness, durability, and comfort. In our workshop, high-tech materials and old world craftsmanship meet as expert hands lay carbon filaments along a mold with diamond and scallop patterns, in a seemingly never-ending radial pattern.

Lightweight, delicate; yet deceptively sturdy. This is the "Spin" collection. A perfect blend of beauty, lightness, and strength

EASYCHAIR

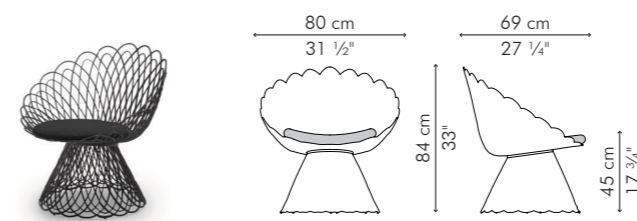

SIDE CHAIR

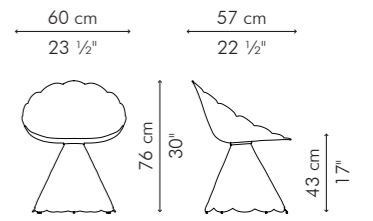

INDOOR carbon fiber

Black





ZAZA

Its leaves cast a dramatic play of light and bends gracefully giving a canopy of shade, as though, sitting under a palm tree. Delicate fronds of our "Zaza," intricately weaved using microfiber, fan out an elegant tapestry of a leaf blade. Its impressive plume-like frills are anchored with Fiber-Reinforced Polymer and steel. "Zaza" is our whimsical interpretation of a palm tree. Sit cozily on our "Zaza." Indulge in the zesty feel of tropical beaches and beautiful landscapes inside your home.

EASY ARMCHAIR

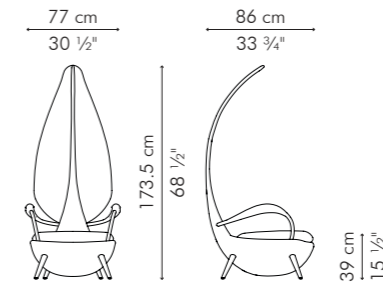

INDOOR microfiber, urethan foam, fiberglass reinforced polymer, wood, steel

- Black
- Lime Green
- Moss Green





kennethcobonpue.com