





SETTING FITTINGS					
FITTINGS	SPEC.	AMOUNT	FITTINGS	SPEC.	AMOUNT
A		4 pcs	C		8 pcs
B		8 pcs	D		1 pcs

**FIG.**  
**1**



**FIG.**  
**2**

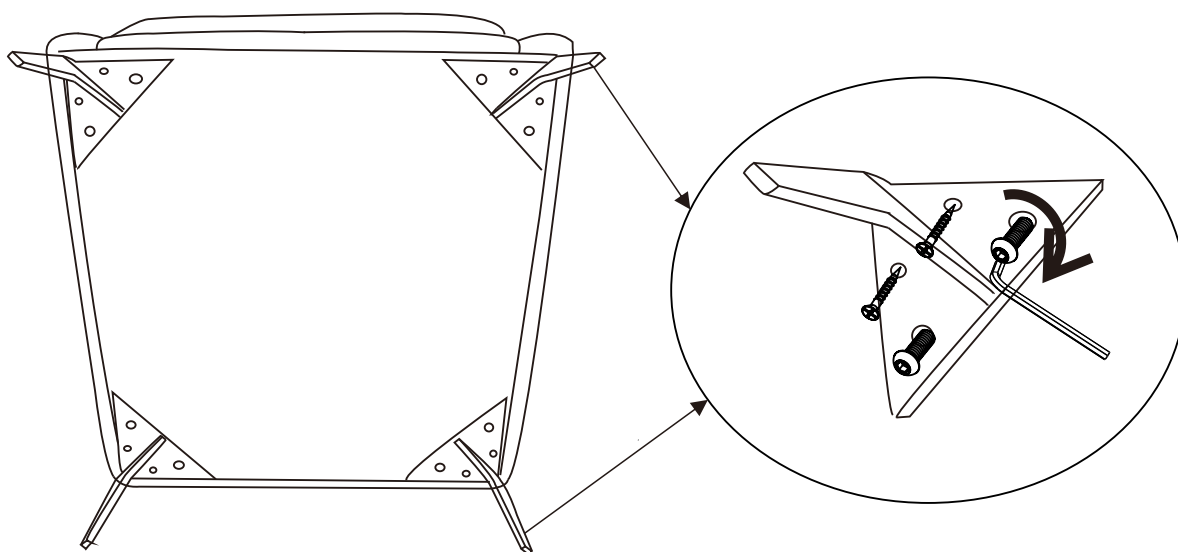