

indoor

# Team Shelf / estantería

Mario Ruiz, 2015/2021

T851 120



Furniture system made of solid wood from European oaks and metallic frame. Shelf width: 47.25". The collection is also available in a lacquered version (MDF). Adjustable PA spacers.

Sistema de mobiliario fabricado en madera maciza de roble europeo y estructura metálica. Ancho de estantería: 120 cm. La colección también está disponible en versión lacada (MDF). Conteras regulables de inyección de PA.

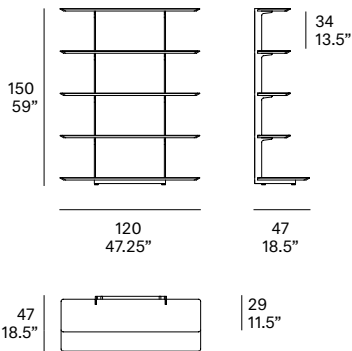

## Shipment details

Qty	1 shelf (3 boxes)
Volume	0,62 m <sup>3</sup> / 22 ft <sup>3</sup>
Gross weight	60 kg / 132.5 lb
Net weight	53 kg / 117 lb
Item dimensions (width x depth x height)	120 x 47 x 150 cm 47.25" x 18.5" x 59"

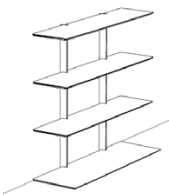

**expormim**

Expormim S.A.  
Pol. Ind. Jaime I  
46640 Moixent (Valencia) Spain  
+34 962 295 144/5  
export@expormim.com  
www.expormim.com

Expormim USA LLC  
(212) 204-8572  
usa@expormim.com  
www.expormim.com

1/3

indoor

**Shelves**

**solid wood**



W01 natural oak



W03 light oak



W02 white stained



W05 dark stained

**textured lacquers**



LT24 linen

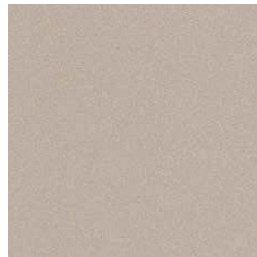

LT09 champagne



LT10 bronze

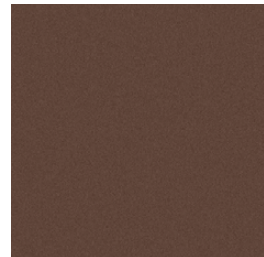

LT26 sable brown



LT11 graphite

**lacquers**

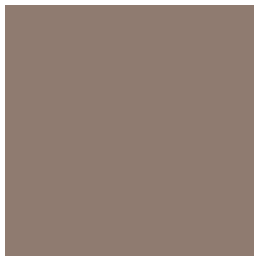

L5 taupe

**expormim**

Expormim S.A.  
Pol. Ind. Jaime I  
46640 Moixent (Valencia) Spain  
+34 962 295 144/5  
export@expormim.com  
www.expormim.com

Expormim USA LLC  
(212) 204-8572  
usa@expormim.com  
www.expormim.com

indoor

**Metallic structure**

**metallic finishes- fine textured**



124 FT linen



102 FT light grey

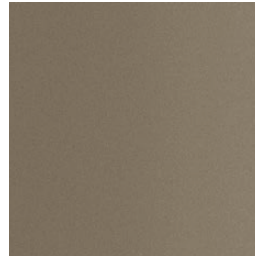

110 FT bronze



108 FT oxide

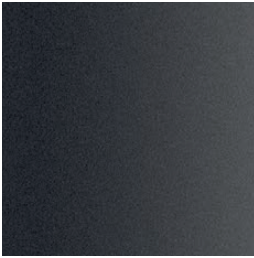

111 FT graphite