

Products / Lamps / The Factory Lamp S

# The factory lamp s

by Ramón Esteve

The Factory Collection, designed by Ramon Esteve for Vondom, is **characterized by the aluminum profile and the “deployé” mesh**. Discover this collection of aluminium furniture composed of a modular sofa, an armchair, a lounger, a side table, a lamp, a coffee table, a high table, chairs, and a room divider.



# Info

---

## Description

Designer lamp. The deployed mesh is made from aluminum, and the inner lighting is made out of polyethylene resin manufactured by rotational molding. Suitable for an interior and an outdoor use. Available in various finishes.

Weight: 3.99 Kg

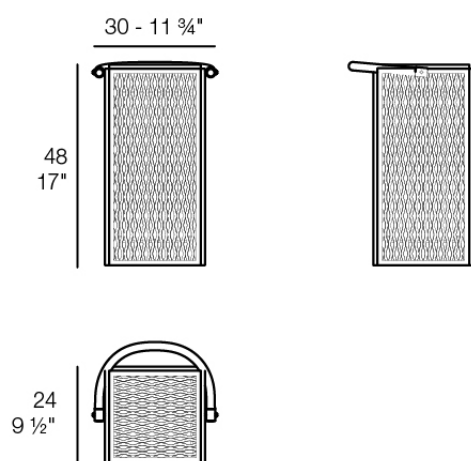

THE FACTORY Lámpara 30 x 24 x 48  
THE FACTORY Puff S 11 3/4 x 9 1/2 x 19"

# Finishes

---

## lighting

---

### RGBW LED BATTERY

Ref. 54612Y

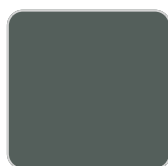

modo green



ecru



black



purjai red

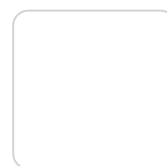

white



notte blue



british gray

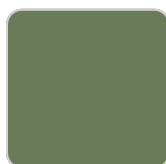

pickle



traffic gray



almond



crema

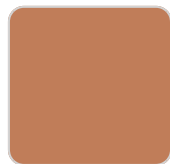

melon



castoro fiber



bronze



red

Unit with internal lighting with battery-powered RGBW LED technology. Includes charger and remote control for switching colors and charger. Available only in matte ice white finish.

### RGBW LED DMX BATTERY

Ref. 54612DY



modo green

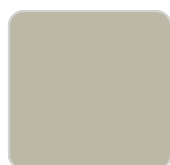

ecru



black



purjai red

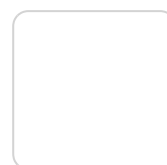

white



notte blue



british gray



pickle



traffic gray

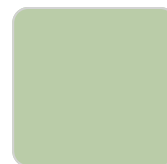

almond

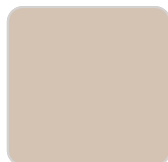

crema

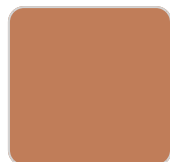

melon



castoro fiber



mostaza



bronze



red

Unit with internal lighting with RGBW LED technology and remote control unit for switching colors. Also controlled by DMX-1024 (wireless), enabling communication between one or more products simultaneously via the DMX transmitter (not included). There are two options to choose from: Professional XLR DMX and Home WIFI DMX. (Remote control included).

# Ambients

---

