

indoor

Huma

Swivel armchair with 5 casters / sillón giratorio con cinco ruedas

Mario Ruiz, 2015/2021

T070 SF



Swivel armchair with structure made of peeled and tinted natural rattan of 1.1" diameter. Backrest manufactured in peeled and tinted natural rattan of 0.4" diameter. Finished with a three step water-based coating (dye, base coat and top coat) highly resistant to solar radiation thanks to UV filters. Upholstered seat and metal legs with casters. Possibility of customization through a wide variety of high performance technical fabrics. · Gas height adjustment

Sillón giratorio con estructura en rattan natural pelado y tintado de 28 mm de calibre. Respaldo fabricado en rattan natural pelado y tintado de 10 mm de calibre. Acabado con recubrimiento en tres fases (tinte, fondo y acabado) con filtros UV que lo hacen altamente resistente a la radiación solar. Los acabados utilizados son en base al agua. Asiento tapizado y patas metálicas con ruedas. Posibilidad de personalización mediante una amplia variedad de tejidos técnicos de altas prestaciones de uso. · Ajuste de altura de gas

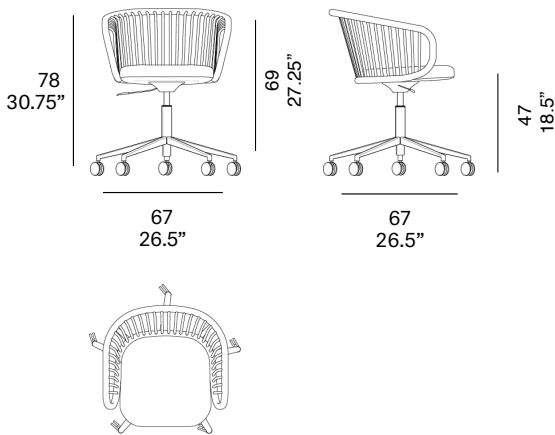

Shipment details

Qty	1 armchair (1 box)
Volume	0,43 m ³ / 15.1 ft ³
Gross weight	17 kg / 37,47 lb
Net weight	13 kg / 28.6 lb
Box dimensions (approx.)	72 x 72 x 83 cm 28,3" x 28,3" x 32,75"
Item dimensions (width x depth x height)	67 x 67 x 78 cm 26.5" x 26.5" x 30.75"
COM (1, 40 - 1,50 m / 54"-59")	0,65 m / 0.7 yd

Expormim S.A.
Pol. Ind. Jaime I
46640 Moixent (Valencia) Spain
+34 962 295 144/5
export@expormim.com
www.expormim.com

Expormim USA LLC
(212) 204-8572
usa@expormim.com
www.expormim.com

1/5

Rattan

tinted



R10 natural



R03 noce



R06 verde oliva



R08 azzurro



R07 mogano



R24 cinder purple



R23 french grey



R05 grigio



R09 nero

lacquered



R02 bianco



R22 clay



R17 forest green

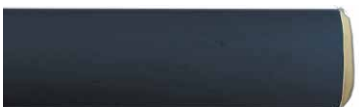

R16 navy blue



R14 japanese red



indoor

legs / patas

metallic finishes / metales



601 FT black

indoor

Cushions / confección

group 1 - natté Sunbrella®



natté white

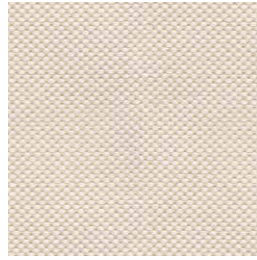

natté canvas



natté taupe chalk

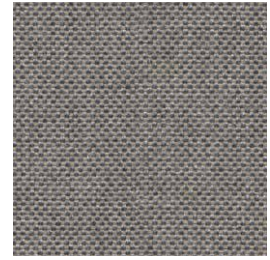

natté carbon beige



natté dark taupe



natté carbon sky

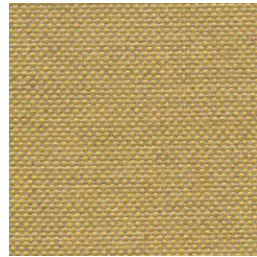

natté amber

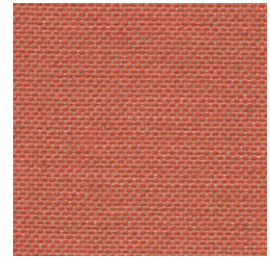

natté flamingo

group 1 - dolce Crevin®



dolce 07



dolce 16

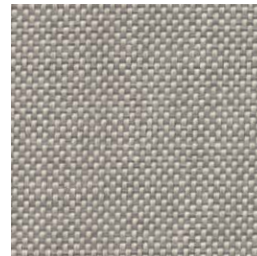

dolce 75



dolce 53

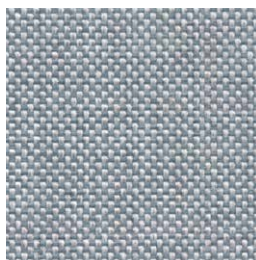

dolce 43

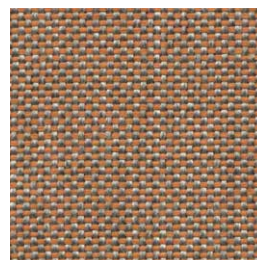

dolce 24



dolce 30

indoor

Cushions / confección

group 1 - valencia™ faux leather



valencia 1049



valencia 0020

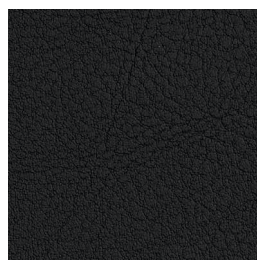

valencia 9035

group 2 - ito Crevin®



ito 05

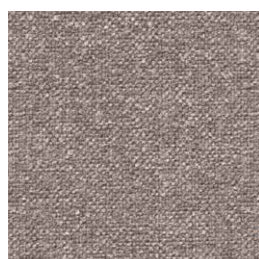

ito 18



ito 12



ito 71

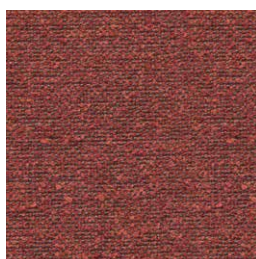

ito 21



ito 20



ito 38



ito 45

group 2 - sacco Crevin®



sacco 02



sacco 05



sacco 11

expormim

Expormim S.A.
Pol. Ind. Jaime I
46640 Moixent (Valencia) Spain
+34 962 295 144/5
export@expormim.com
www.expormim.com

Expormim USA LLC
(212) 204-8572
usa@expormim.com
www.expormim.com

indoor

Cushions / confección

group 3 - ascendent Carlucci®



ascendent 090



ascendent 070



ascendent 071



ascendent 030



ascendent 093



ascendent 022



ascendent 040

group 3 - elmosoft Elmo® leather



elmosoft 22024



elmosoft 93129

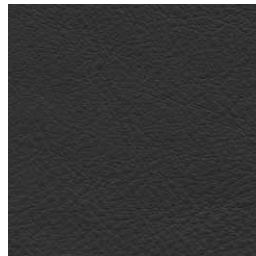

elmosoft 99999