

DUO by Rafa García, 2004/2022

DUO MAXI

EXPLICACION DEL MODELO

DUO. Dos familias en una: MINI & MAXI

Estético y muy funcional, este básico en nuestro catálogo es un diseño de **Rafa García**. El diseñador reinterpreta con audacia esta creación para actualizarlo con dos versiones más contemporáneas. **Mini & Maxi** son la nueva propuesta definida para satisfacer las necesidades de diferentes espacios, bien domésticos o colectivos.

Su carácter modular le confiere una identidad flexible y versátil, especialmente gracias a las nuevas medidas. La diferencia entre **Mini & Maxi** es el fondo de su asiento y la modulación disponible. Además, para que cada uno de los módulos pueda usarse de forma independiente, hemos perfilado sus acabados a todos los niveles, porque cada pequeño detalle cuenta.

En la versión **Mini**, las reducidas dimensiones y la sencillez de la modularidad disponible facilitan el amueblamiento de espacios recogidos y compactos, propios de las grandes ciudades. Éstos pueden funcionar sueltos a modo de silloncito.

Por otra parte, la versión **Maxi** propone ampliar el ancho de algunos módulos para obtener sofás de una sola pieza con generosas dimensiones. Su modulación es extensa e incluye módulos con brazo o sin brazo, módulos terminales, angulares y un puf que, articulados de forma variada, hacen posibles configuraciones casi infinitas, ideales para espacios públicos. También cabe destacar como novedad la posibilidad de realizar composiciones curvadas.

La amplia sentada de **Duo Maxi** permite jugar con cojines de decoración e, incluso, incorporar almohadones de respaldo extra.

Sus patas quedan ocultas, haciendo que su voluminosa silueta parezca flotar con ligereza sobre el suelo.



DUO MINI

DESCRIPTION

DUO. Two families in one: MINI & MAXI

Both aesthetic and highly functional, the **Duo** by **Rafa García** has been a staple in our catalogue since 2004. Eighteen years later, the designer has boldly reinterpreted his creation, replacing it with **Duo Mini and Duo Maxi**.

Their sectional character gives them a flexible and versatile identity, accentuated by new sizes. The main differences between **Mini and Maxi** are the depth of the seat and the modules available. In addition, each of the modules can now be used independently and we have improved the finishes as every little detail counts.

The **Mini** version's reduced footprint, and the simplicity of its modules make it an ideal choice to furnish the compact spaces characteristic of large cities. Each module can even be used as a small, independent armchair.

On the other hand, the **Maxi** version extends the width of some modules to create single-piece sofas with generous dimensions. Its wide selection of modules includes elements with or without arms, end and corner modules and a pouf. They can be combined in a variety of ways to create almost infinite configurations, ideal for open public spaces. Another new feature is the possibility of creating curved compositions.

Duo Maxi's deep seat enables the playful use of scatter cushions or even extra back cushions.

Its hidden feet make its voluminous silhouette appear to float gracefully above the floor.

FIRMEZA / FIRMNESS / FERMETÉ

SUAVE
SOFT
DOUX



FIRME
FIRM
FERME

ACABADOS / FINISHES / FINITIONS

PATAS / FEET / PIED

HAYA / BEECH / HÊTRE

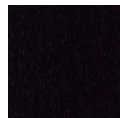

030 WENGUE PLUS

IMPORTANTE

No es tapizable en piel. Los módulos tapizados en tela son totalmente desenfundables, aunque es necesario desmontar el asiento del respaldo. Incluye instrucciones.

Almohadas de respaldo opcionales no incluidas en el precio.

La unión de los módulos se realiza mediante carracas.

Las solicitudes de composiciones modulares deben adjuntar un plano en planta al realizar el pedido. La mano (derecha/izquierda) se interpreta siempre viendo el dibujo de frente.

CARACTERISTICAS TECNICAS**TELA**

- Módulos totalmente desenfundables.
- Estructura asiento: estructura de madera preparada con cinchas elásticas de 80mm en el asiento, recubierto con espuma de densidad diferenciada (CMHR 30kg/35kg /60), revestido con fibra de H100gr con velour.
- Estructura respaldo y brazo: estructura de madera, recubierto con espuma de densidad diferenciada (CMHR 30kg/35kg y CM25kg), revestido con fibra de H100gr con velour.
- Patas en madera de haya, acabadas en wengué plus (las patas quedan ocultas).
- Almohadas decoración respaldo y riñonera: funda de algodón rellena de FiberDream (microfibra tacto plumón).

PIEL

- No se fabrica.

IMPORTANT

This model is not available in leather. Totally removable fabric covers, although it is necessary to remove the seat from the backrest. Includes instructions.

Optional back cushions not included in the price.

The modules are joined by a ratchet system.

Requests for modular combinations must have a plan attached when placing the order. Left and right as facing the piece.

TECHNICAL CHARACTERISTICS**FABRIC**

- Totally removable covers.
- Seat structure: wood fitted with 80mm elastic webbing, covered with foam of varying densities (CMHR 30kg/35kg/60kg), covered in H100g fibre.
- Back and arm structure: wood, covered with foam of varying densities (CMHR 30kg/35kg and CM25kg), covered in H100g fibre.
- Solid beech feet stained in wenge plus (hidden feet).
- Scatter and lumbar cushions: cotton cover with FiberDream interiors (a down-like microfibre).

LEATHER

- This product is not available in leather.

DUO MAXI

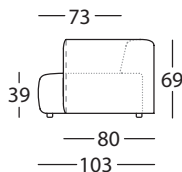

-15 CM.
FONDO / DEPTH



DUO MINI

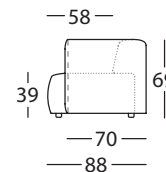

Los asientos de los módulos del Duo Maxi tienen 15 cm. más de fondo que los asientos de los módulos del Duo Mini.
The seats of the modules of Duo Maxi are 15 cm. deeper than the seats of the Duo Mini modules.

DUO MAXI

Ejemplos de composición / Composition examples

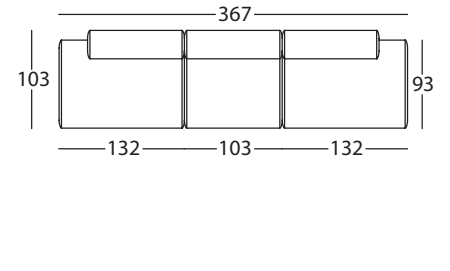
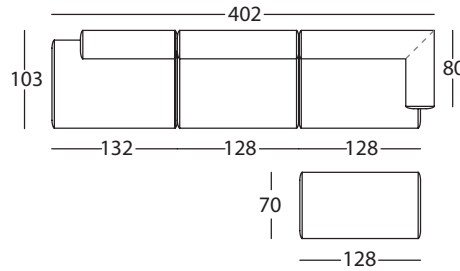
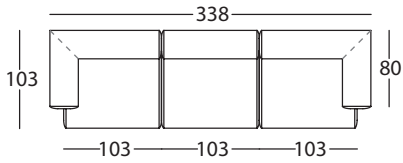

Ref.: 364122.M.I 364121.L 364122.M.D

36417.N.I 364121.N 364122.Q.D

36417.N.I 364121.L 36417.N.D

364151.NH

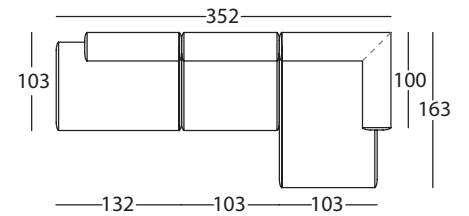
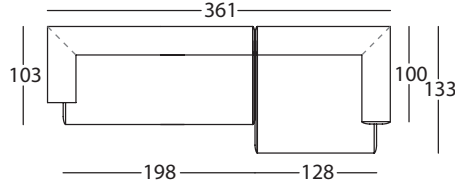
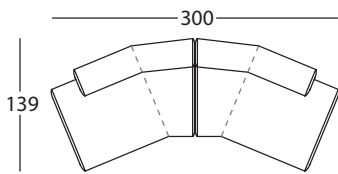

Ref.: 36417S.AN.I 36417S.AN.D

364122.X.I 364142.Q.P.D

36417.N.I 364121.L 364142.MS.D

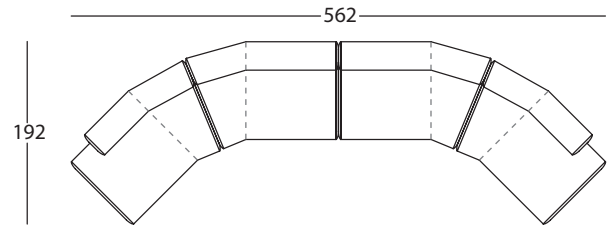
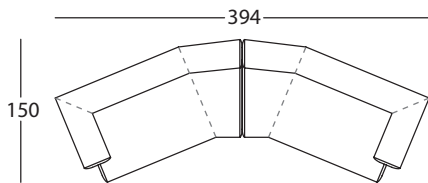

Ref.: 36416.W.I 36416.W.D

36417S.AN.I 36416.S.I 36416.S.D 36417S.AN.D

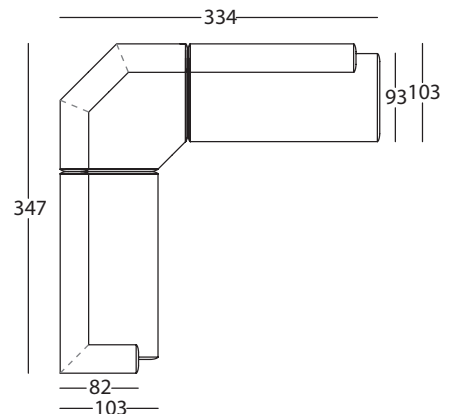
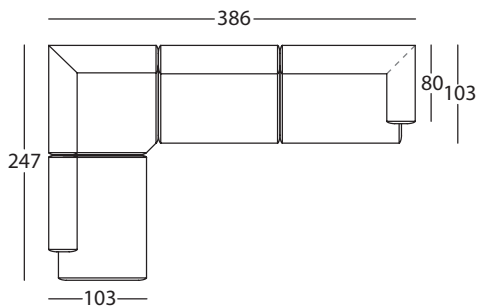

Ref.: 364161.M 364121.N 364122.M.D

364161.P 36417.M.D

36417.N.I

364122.X.I

DUO by Rafa García, 2004/2022

DUO MAXI

Modulos con brazo / Modules with arm / Modules avec bras

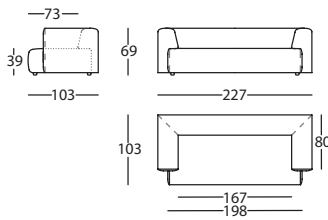

364.11.Z
 DUO MAXI SOFA 227
 DUO MAXI SOFA 227
 DUO MAXI CANAPE 227
 1,78 m³ / 1 Pack. / 88,4 kg

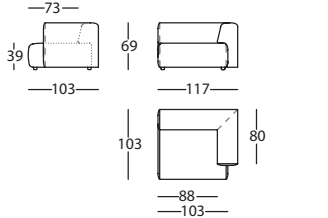

364.122.M.D
 DUO MAXI MODULO 117 BR DCHO
 DUO MAXI MODULE 117 RIGHT ARM
 DUO MAXI MODULE 117 BRAS DROIT
 0,91 m³ / 1 Pack. / 46,9 kg

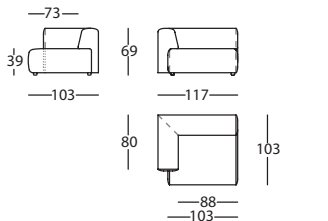

364.122.M.I
 DUO MAXI MODULO 117 BR IZDO
 DUO MAXI MODULE 117 LEFT ARM
 DUO MAXI MODULE 117 BRAS GAUCHE
 0,91 m³ / 1 Pack. / 46,9 kg

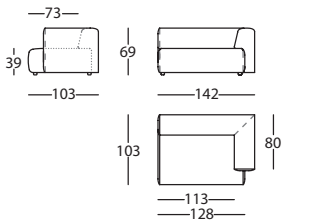

364.122.Q.D
 DUO MAXI MODULO 142 BR DCHO
 DUO MAXI MODULE 142 RIGHT ARM
 DUO MAXI MODULE 142 BRAS DROIT
 1,1 m³ / 1 Pack. / 54,7 kg

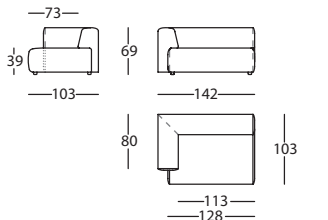

364.122.Q.I
 DUO MAXI MODULO 142 BR IZDO
 DUO MAXI MODULE 142 LEFT ARM
 DUO MAXI MODULE 142 BRAS GAUCHE
 1,1 m³ / 1 Pack. / 54,7 kg

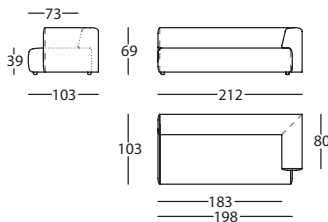

364.122.X.D
 DUO MAXI MODULO 212 BR DCHO
 DUO MAXI MODULE 212 RIGHT ARM
 DUO MAXI MODULE 212 BRAS DROIT
 1,66 m³ / 1 Pack. / 75,9 kg

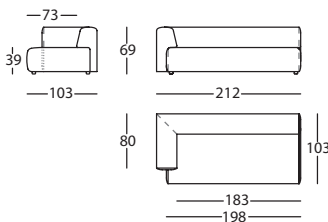

364.122.X.I
 DUO MAXI MODULO 212 BR IZDO
 DUO MAXI MODULE 212 LEFT ARM
 DUO MAXI MODULE 212 BRAS GAUCHE
 1,66 m³ / 1 Pack. / 75,9 kg

Modulos ángulo / Corner modules / Module angle

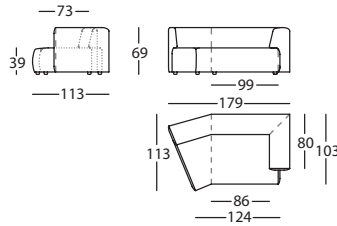

364.16.T.D
 DUO MAXI MODULO 179 BR DCHO ANGULO 22.5°
 DUO MAXI MODULE 179 RIGHT ARM CORNER 22.5°
 DUO MAXI MODULE 179 BRAS DROIT ANGLE 22.5°
 1,47 m³ / 1 Pack. / 62,5 kg

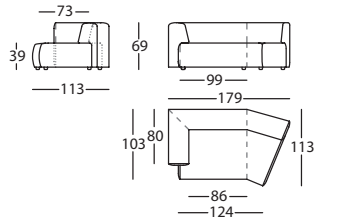

364.16.T.I
 DUO MAXI MODULO 179 BR IZDO ANGULO 22.5°
 DUO MAXI MODULE 179 LEFT ARM CORNER 22.5°
 DUO MAXI MODULE 179 BRAS GAUCHE ANGLE 22.5°
 1,47 m³ / 1 Pack. / 62,5 kg

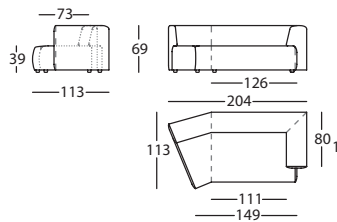

364.16.W.D
 DUO MAXI MODULO 204 BR DCHO ANGULO 22.5°
 DUO MAXI MODULE 204 RIGHT ARM CORNER 22.5°
 DUO MAXI MODULE 204 BRAS DROIT ANGLE 22.5°
 1,68 m³ / 1 Pack. / 70,3 kg

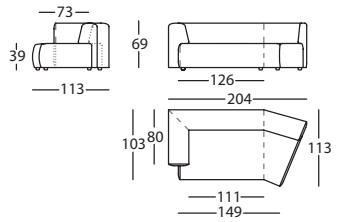

364.16.W.I
 DUO MAXI MODULO 204 BR IZDO ANGULO 22.5°
 DUO MAXI MODULE 204 LEFT ARM CORNER 22.5°
 DUO MAXI MODULE 204 BRAS GAUCHE ANGLE 22.5°
 1,68 m³ / 1 Pack. / 70,3 kg

DUO by Rafa García, 2004/2022

DUO MAXI

Modulos / Modules

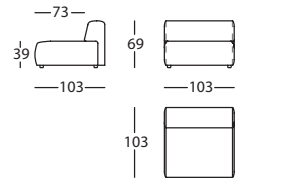
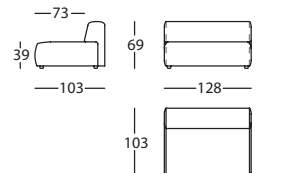
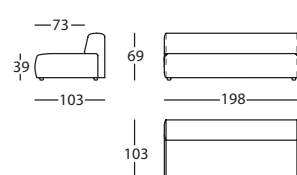
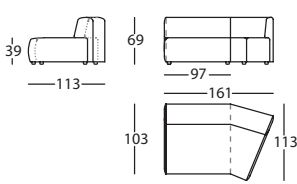
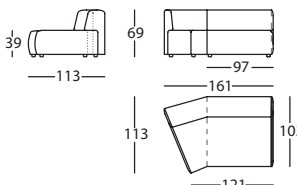
	<p>364.121.L</p> <p>DUO MAXI MODULO 103 DUO MAXI MODULE 103 DUO MAXI MODULE 103</p> <p>0,78 m³ / 1 Pack. / 38,4 kg</p>
	<p>364.121.N</p> <p>DUO MAXI MODULO 128 DUO MAXI MODULE 128 DUO MAXI MODULE 128</p> <p>0,97 m³ / 1 Pack. / 45,2 kg</p>
	<p>364.121.V</p> <p>DUO MAXI MODULO 198 DUO MAXI MODULE 198 DUO MAXI MODULE 198</p> <p>1,5 m³ / 1 Pack. / 67,3 kg</p>
	<p>364.16.S.D</p> <p>DUO MAXI MODULO 161 ANGULO 22.5° DCHO DUO MAXI MODULE 161 CORNER 22.5° RIGHT DUO MAXI MODULE 161 ANGLE 22.5° DROIT</p> <p>1,34 m³ / 1 Pack. / 57 kg</p>
	<p>364.16.S.I</p> <p>DUO MAXI MODULO 161 ANGULO 22.5° IZDO DUO MAXI MODULE 161 CORNER 22.5° LEFT DUO MAXI MODULE 161 ANGLE 22.5° GAUCHE</p> <p>1,34 m³ / 1 Pack. / 57 kg</p>

Chaise / Chaise longue

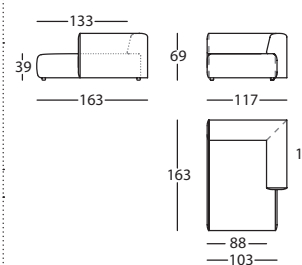
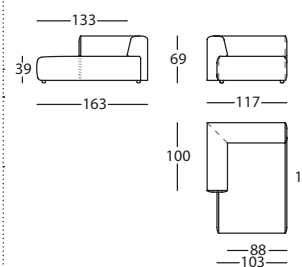
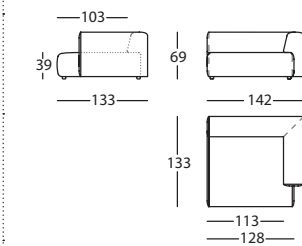
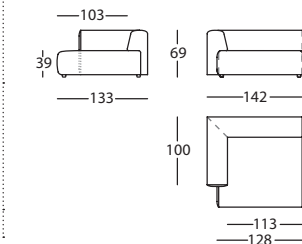
	<p>364.142.MS.D</p> <p>DUO MAXI CHAISE 117X163 BR DCHO DUO MAXI CHAISE 117X163 RIGHT ARM DUO MAXI CHAISE 117X163 BRAS DROIT</p> <p>1,43 m³ / 1 Pack. / 63,5 kg</p>
	<p>364.142.MS.I</p> <p>DUO MAXI CHAISE 117X163 BR IZDO DUO MAXI CHAISE 117X163 LEFT ARM DUO MAXI CHAISE 117X163 BRAS GAUCHE</p> <p>1,43 m³ / 1 Pack. / 63,5 kg</p>
	<p>364.142.QP.D</p> <p>DUO MAXI CHAISE 142X133 BR DCHO DUO MAXI CHAISE 142X133 RIGHT ARM DUO MAXI CHAISE 142X133 BRAS DROIT</p> <p>1,41 m³ / 1 Pack. / 60 kg</p>
	<p>364.142.QP.I</p> <p>DUO MAXI CHAISE 142X133 BR IZDO DUO MAXI CHAISE 142X133 LEFT ARM DUO MAXI CHAISE 142X133 BRAS GAUCHE</p> <p>1,41 m³ / 1 Pack. / 60 kg</p>

DUO by Rafa García, 2004/2022

DUO MAXI

Terminales / Terminals

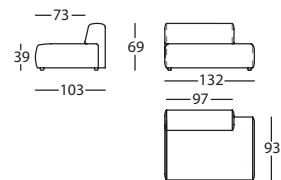

364.17.N.D

DUO MAXI TERMINAL 132 DCHO
DUO MAXI RIGHT TERMINAL 132
DUO MAXI TERMINAL 132 DROIT

0,97 m³ / 1 Pack. / 45,2 kg

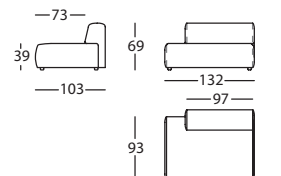

364.17.N.I

DUO MAXI TERMINAL 132 IZDO
DUO MAXI LEFT TERMINAL 132
DUO MAXI TERMINAL 132 GAUCHE

0,97 m³ / 1 Pack. / 45,2 kg

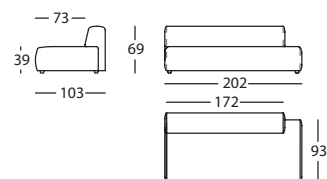

364.17.V.D

DUO MAXI TERMINAL 202 DCHO
DUO MAXI RIGHT TERMINAL 202
DUO MAXI TERMINAL 202 DROIT

1,5 m³ / 1 Pack. / 73,3 kg

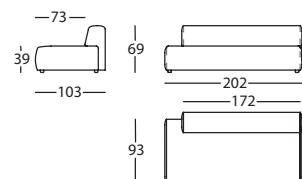

364.17.V.I

DUO MAXI TERMINAL 202 IZDO
DUO MAXI LEFT TERMINAL 202
DUO MAXI TERMINAL 202 GAUCHE

1,5 m³ / 1 Pack. / 73,3 kg

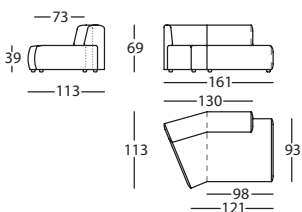

364.17.S.AN.D

DUO MAXI TERMINAL 161 DCHO ANGULO 22.5°
DUO MAXI RIGHT TERMINAL 161 CORNER 22.5°
DUO MAXI TERMINAL DROIT 161 ANGLE 22.5°

1,34 m³ / 1 Pack. / 55 kg

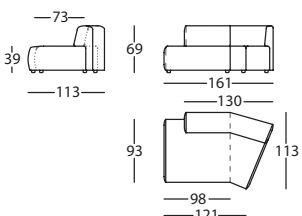

364.17.S.AN.I

DUO MAXI TERMINAL 161 IZDO ANGULO 22.5°
DUO MAXI LEFT TERMINAL 161 CORNER 22.5°
DUO MAXI TERMINAL GAUCHE 161 ANGLE 22.5°

1,34 m³ / 1 Pack. / 55 kg

Angulo y puf / Corner & pouf / Angle et pouf

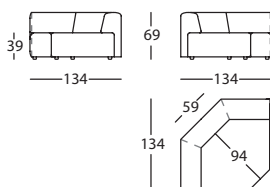

364.161.P

DUO MAXI ANGULO 90° 134X134
DUO MAXI 90° CORNER 134X134
DUO MAXI ANGLE 90° 134X134

1,33 m³ / 1 Pack. / 60,7 kg

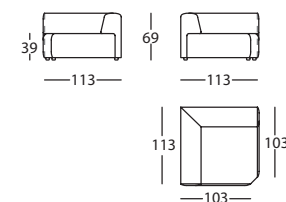

364.161.M

DUO MAXI ANGULO 90° 113X113
DUO MAXI 90° CORNER 113X113
DUO MAXI ANGLE 90° 113X113

0,98 m³ / 1 Pack. / 51,6 kg

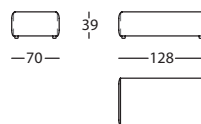

364.151.NH

DUO MAXI PUF 128X70
DUO MAXI POUF 128X70
DUO MAXI POUF 128X70

0,39 m³ / 1 Pack. / 20 kg

Almohadas / Cushions

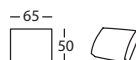

364.21.HF

DUO MAXI ALMOHADA DECORACION 65X50
DUO MAXI SCATTER CUSHION 65X50
DUO MAXI COUSSIN 65X50

- m³ / 1 Pack. / 2,2 kg

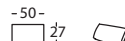

364.27.FC

DUO MAXI ALMOHADA RIÑONERA 50X27
DUO MAXI LUMBAR CUSHION 50X27
DUO MAXI COUSSIN CALE REIN 50X27

- m³ / 1 Pack. / 0,8 kg

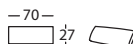

364.27.HC

DUO MAXI ALMOHADA RIÑONERA 70X27
DUO MAXI LUMBAR CUSHION 70X27
DUO MAXI COUSSIN CALE REIN 70X27

- m³ / 1 Pack. / 1,2 kg

DUO MINI

Ejemplos de composición / Composition examples

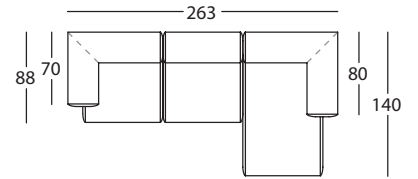
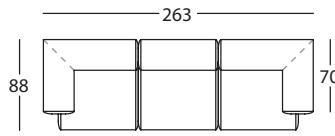
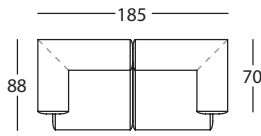

Ref: 365.122.K.I 365.122.K.D

365.122.K.I 365.121.H 365.122.K.D

365.122.K.I 365.121.H 365.142.K.D

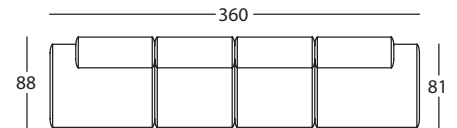
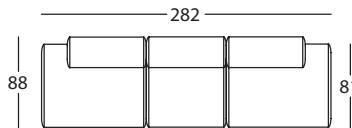
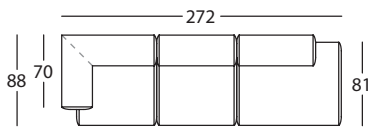

Ref: 365.122.K.I 365.121.H 365.17.L.D

365.17.L.I 365.121.H 365.17.L.D

365.17.L.I 365.121.H 365.121.H 365.17.L.D

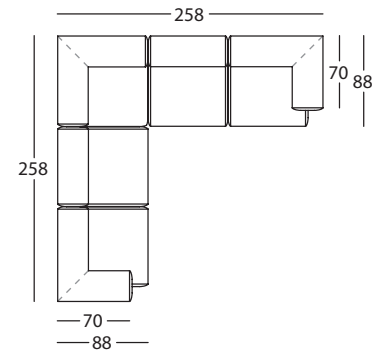
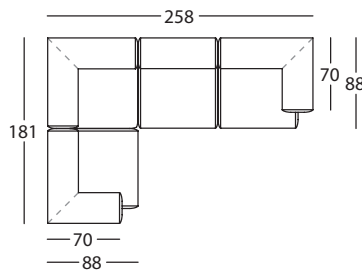
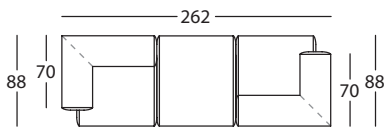

Ref: 365.122.K.I 365.151.H 365.122.K.I

365.161.J 365.121.H 365.122.K.D

365.161.J 365.121.H 365.122.K.D

365.122.K.I

365.121.H

365.122.K.I

DUO by Rafa García, 2004/2022

DUO MINI

Modulos y Chaise / Modules and Chaise longue /
Modules et Chaise longue

Terminal, ángulo y puf / Terminal, corner and pouf /
Terminal, angle et pouf

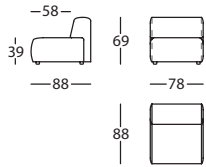

365.121.H

DUO MINI MODULO 78
DUO MINI MODULE 78
DUO MINI MODULE 78

0,51 m³ / 1 Pack. / 27,4 kg

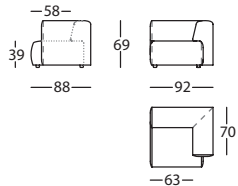

365.122.K.D

DUO MINI MODULO 92 BR DCHO
DUO MINI MODULE 92 RIGHT ARM
DUO MINI MODULE 92 BRAS DROIT

0,62 m³ / 1 Pack. / 35,2 kg

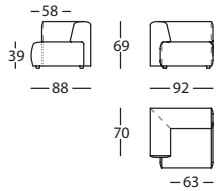

365.122.K.I

DUO MINI MODULO 92 BR IZDO
DUO MINI MODULE 92 LEFT ARM
DUO MINI MODULE 92 BRAS GAUCHE

0,62 m³ / 1 Pack. / 0 kg

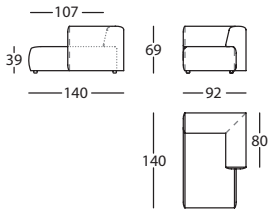

365.142.K.D

DUO MINI CHAISE 92X140 BR DCHO
DUO MINI CHAISE 92X140 RIGHT ARM
DUO MINI CHAISE 92X140 BRAS DROIT

0,98 m³ / 1 Pack. / 44,9 kg

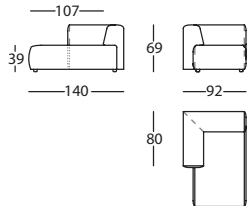

365.142.K.I

DUO MINI CHAISE 92X140 BR IZDO
DUO MINI CHAISE 92X140 LEFT ARM
DUO MINI CHAISE 92X140 BRAS GAUCHE

0,98 m³ / 1 Pack. / 44,9 kg

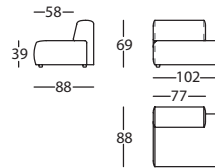

365.17.L.D

DUO MINI TERMINAL 102 DCHO
DUO MINI RIGHT TERMINAL 102
DUO MINI TERMINAL 102 DROIT

0,67 m³ / 1 Pack. / 34,5 kg

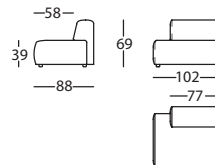

365.17.L.I

DUO MINI TERMINAL 102 IZDO
DUO MINI LEFT TERMINAL 102
DUO MINI TERMINAL 102 GAUCHE

0,67 m³ / 1 Pack. / 34,5 kg

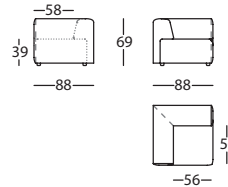

365.161.J

DUO MINI ANGULO 90° 88X88
DUO MINI 90° CORNER 88X88
DUO MINI ANGLE 90° 88X88

0,58 m³ / 1 Pack. / 39,1 kg

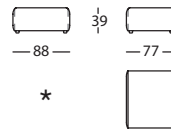

365.151.H

DUO MINI PUF 77X88
DUO MINI POUF 77X88
DUO MINI POUF 77X88

0,27 m³ / 1 Pack. / 19,4 kg

★ Válido para colocarlo entre módulos.
No válido para hacer ángulo.

Can be attached between modules.
Not valid as an angle module.