

indoor

Fontal

Upholstered armchair / sillón tapizado

Oscar Tusquets Blanca, 2012/2017

T012 C



Armchair with structure made of peeled and tinted natural rattan of 1.26" diameter. Finished with a three step water-based coating (dye, base coat and top coat) highly resistant to solar radiation thanks to UV filters. Upholstered seat and backrest. Possibility of customization through a wide variety of high performance technical fabrics. Protective caps with removable plastic-felt inserts.

Sillón con estructura en rattan natural pelado y tintado de 32 mm de calibre. Acabado con recubrimiento en tres fases (tinte, fondo y acabado) con filtros UV que lo hacen altamente resistente a la radiación solar. Asiento y respaldo tapizados. Posibilidad de personalización mediante una amplia variedad de tejidos técnicos de altas prestaciones de uso. Tacos protectores reversibles de plástico-fielto.

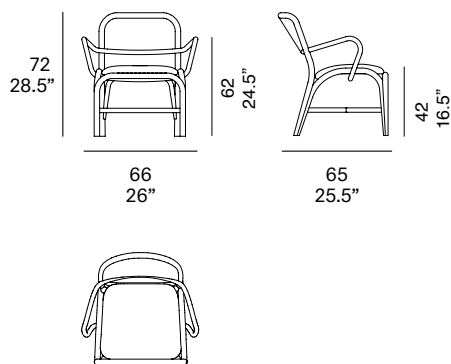

Shipment details

Qty	1 armchair (1 box)
Volume	0,40 m ³ / 14 ft ³
Gross weight	13 kg / 28.5 lb
Net weight	9 kg / 20 lb
Box dimensions (approx.)	68 x 67 x 76 cm 26.75" x 26.5" x 30"
Item dimensions (width x depth x height)	66 x 65 x 72 cm 26" x 25.5" x 28.5"
COM (1, 40 - 1,50 m / 54"-59")	1 m / 1.1 yd

Certifications

EN 16139:2013 (level: L1)
EN 1022:2005

Rattan

Natural_matt



R10 natural

Tinted_matt



R30 oak



R03 noce



R05 grigio



R23 french grey



R06 verde oliva



R08 azzurro



R09 nero

Tinted_gloss



R31 cognac



R32 antique brown



R33 alpine green

Lacquered_matt



R02 bianco



R22 clay



R14 japanese red



indoor

Cushions / confección

group 31 - dolce Crevin®

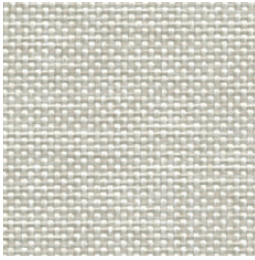

dolce 07

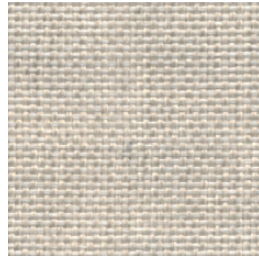

dolce 04

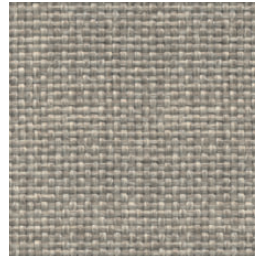

dolce 11

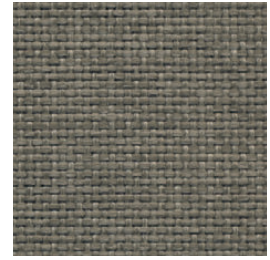

dolce 12

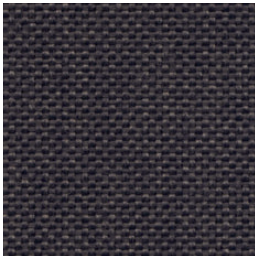

dolce 53

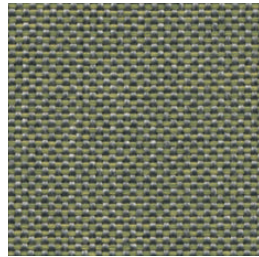

dolce 30

group 31 - ito Crevin®



ito 05

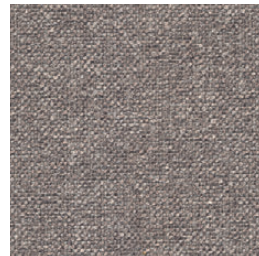

ito 18



ito 12

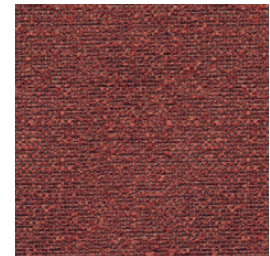

ito 21



ito 20



ito 38

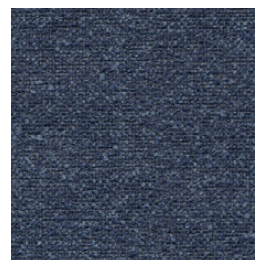

ito 45

indoor

Cushions / confección

group 31 - salvia Crevin®



salvia 02



salvia 20

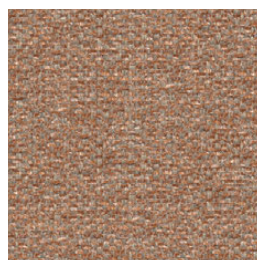

salvia 29

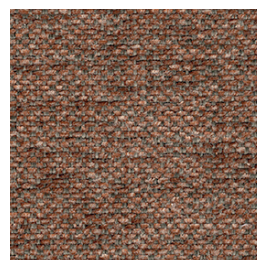

salvia 21



salvia 38

group 31 - sacco Crevin®



sacco 02



sacco 05

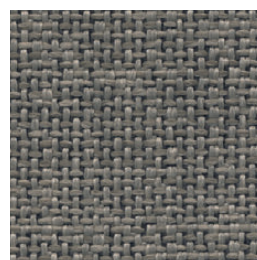

sacco 11

group 31 - valencia™ C5 heritage faux leather



valencia heritage 9050



valencia heritage 9051



valencia heritage 9052



valencia heritage 9055

indoor

Cushions / confección

group 32 - velvety Crevin®



velvety 10



velvety 17

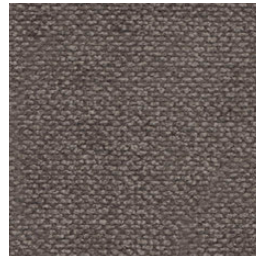

velvety 12



velvety 26

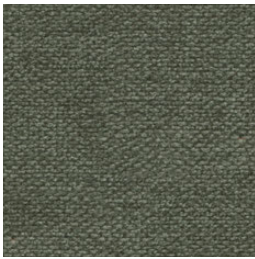

velvety 32

group 32 - indianskop Limonta



indianskop 15



indianskop 02



indianskop 04



indianskop 31



indianskop 46

expormim

Expormim S.A.
Pol. Ind. Jaime I
46640 Moixent (Valencia) Spain
+34 962 295 144/5
export@expormim.com
www.expormim.com

Expormim USA LLC
(212) 204-8572
usa@expormim.com
www.expormim.com

5/7

indoor

Cushions / confección

group 32 - clusone Limonta



clusone 04



clusone 06



clusone 05



clusone 10



clusone 16

group 32 - ascendent reloaded Carlucci®



ascendent reloaded 094

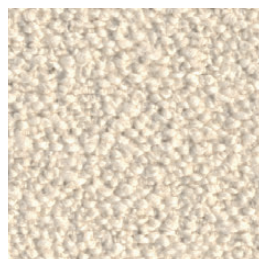

ascendent reloaded 070



ascendent reloaded 071



ascendent reloaded 030

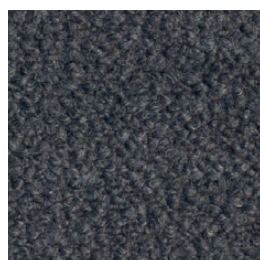

ascendent reloaded 093



ascendent reloaded 022



ascendent reloaded 040

indoor

Cushions / confección

group 33 - elmosoft Elmo® leather

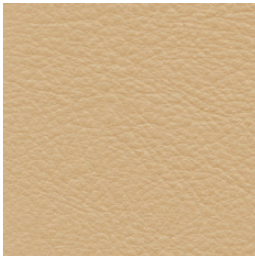

elmosoft 22024



elmosoft 33004

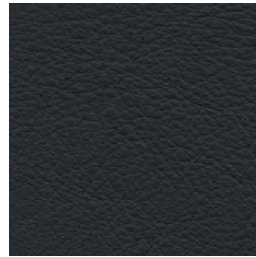

elmosoft 99999