

It's  
hand  
made  
light

news

el**torrent**

# Index

12	<b>Stick</b>
18	<b>Nucli</b>
24	<b>Plise</b>
28	<b>Cuca</b>
34	<b>Cloche</b>
40	<b>Quadra</b>
48	<b>Twice</b>
54	<b>Materials</b>

# Outdoor

Floor lamps  
*Lámparas de pie*

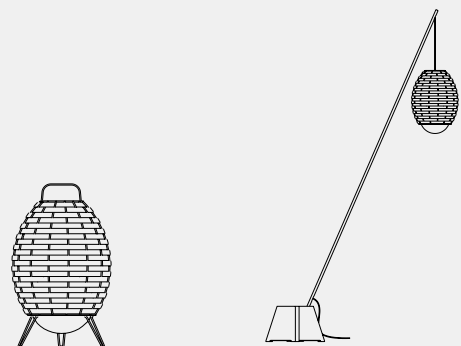

**Cuca**  
28

# Indoor

Pendant lamps  
*Lámparas colgantes*

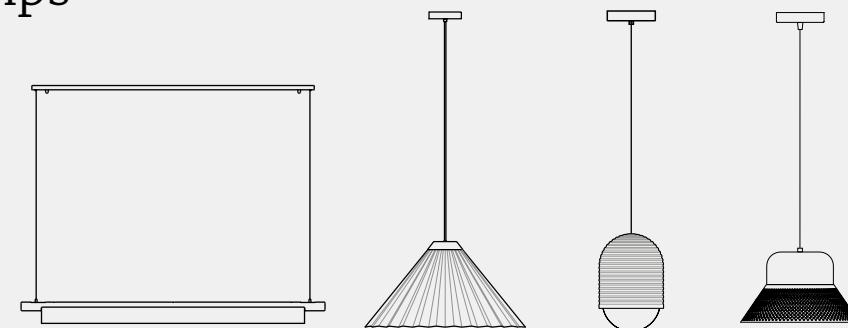

**Stick**  
12

**Plise**  
24

**Nucli**  
18

**Cloche**  
34

Pendant lamps  
*Lámparas Colgantes*

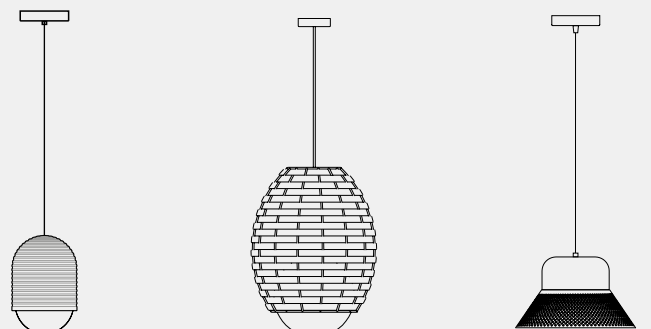

**Nucli**  
18

**Cuca**  
28

**Cloche**  
34

Wall lights  
*Apliques*

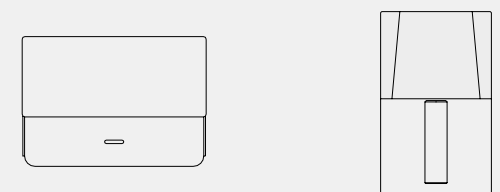

**Quadra**  
40

**Twice**  
48

Table lamps  
*Lámparas de sobremesa*

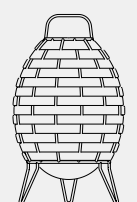

**Cuca**  
28

Table lamps  
*Lámparas de sobremesa*

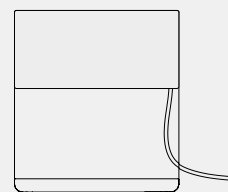

**Quadra**  
40

Floor lamps  
*Lámparas de pie*

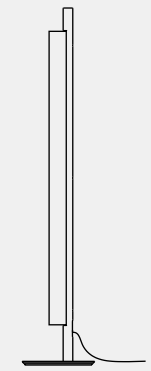

**Stick**  
12

It's  
hand  
made  
light

# Designers



## Joan Genebat

“The challenge and main objective is to successfully convey the desired sensations.

Light has contrasting characters and personalities; we discover them step by step...”

*“Conseguir transmitir sensaciones es el reto y el objetivo más grande.”*

*La luz tiene caracteres y personalidades muy diferentes, se van conociendo poco a poco...”*



## Francesc Crous

“What I intend with design is to explore with the material and its formal behavior, and together with the details that define the object, a harmonious link be established with the user. My interest lies in the identity of things and how they work, have a clear and unequivocal understanding and the desire that this awakens the impulse of proximity.”

*“Lo que pretendo con el diseño es explorar con la materia y su comportamiento formal, y que junto con los detalles que definen el objeto, se establezca un vínculo armónico con el usuario. Mi interés es que la identidad de las cosas y su funcionamiento, tengan una lectura clara e inequívoca, y el afán de que ello despierte el impulso de la cercanía.”*



## Crous Calogero

“We want our objects, materials and details of each product to convey a desire to be touched and observed close up. Functionality is a basic requirement that we consider essential, and on which we try to suggest a narrative, consisting of memories and sensations, generating an intangible bond between object and person.”

*“Queremos que nuestros objetos, la materia y detalle de cada producto, transmitan el deseo de ser tocados y observados de cerca. La funcionalidad es un requisito de base que damos por sentado y sobre el cual tratamos de sugerir una historia, hecha de memorias y sensaciones, que genere el vínculo impalpable entre objeto y persona.”*



## Roger Vancells

“The working method helps reveal the beauty of everyday objects, making them simple, functional and clear, by using attractive, sincere solutions arising from our constant search for innovation”

*“El método de trabajo incide en conseguir revelar la belleza de las cosas cotidianas haciéndolas sencillas, funcionales y claras, utilizando para ello soluciones atractivas, sinceras y fruto de una mirada constante hacia la innovación.”*

news



12 Stick

# Stick

by Roger Vancells

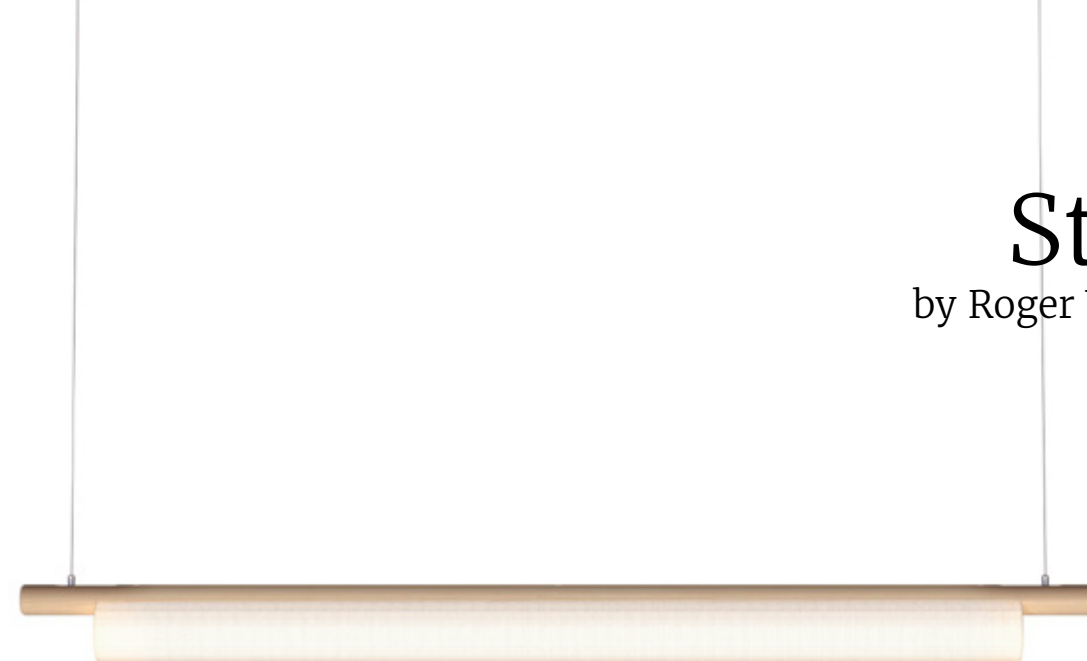

**The STICK luminaire arises from a very simple concept:** two cylindrical shapes that meet together.

Between the wooden structure and the textile shade, the linear LED light source is hidden.

STICK manages to transmit an inspiring environment from the simplicity of its materials, the search for a formal solution with high-quality light and materials.

The two versions: standing and hanging, can be integrated into any architecture or interior environment, thanks to its pure and essential design, as well as being warm and cozy.

**La luminaria STICK surge de un concepto muy simple:** dos formas cilíndricas que se encuentran.

*Es en este punto, entre la estructura de madera y la pantalla textil, donde se consigue esconder la fuente de luz LED lineal.*

*STICK logra transmitir, desde la sencillez de sus materiales, un entorno inspirador, la búsqueda de una solución formal y una gran calidad material y lumínica.*

*Las dos versiones: de pie y suspensión, pueden integrarse en cualquier arquitectura o entorno interior, gracias a su diseño puro y esencial a la vez que cálido y acogedor.*

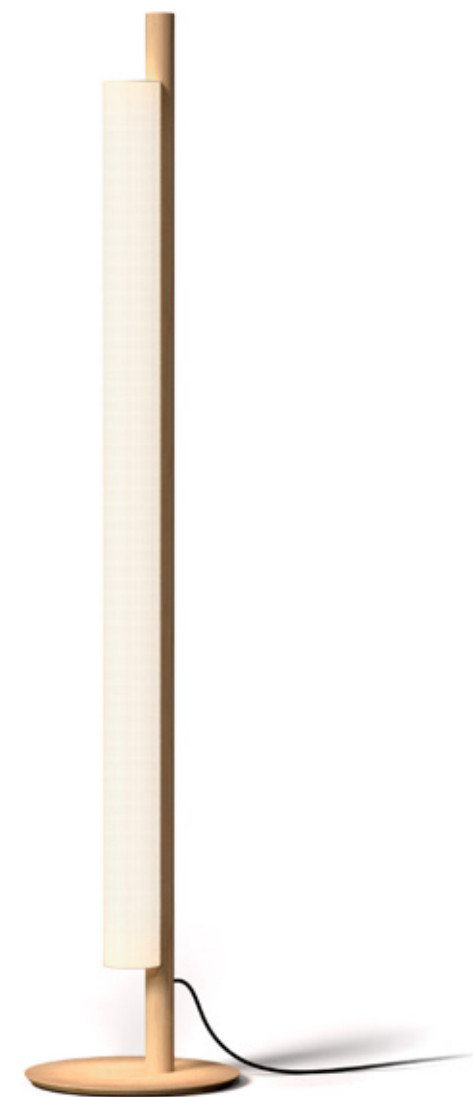

Stick 13





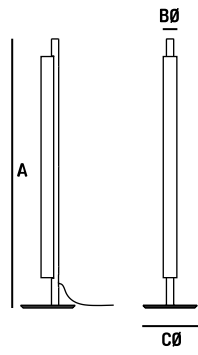

Luminaire made of natural matt finish beech wood and cream colour linen shade (ref. ALW).

Luminaria fabricada en madera de haya acabado mate natural y pantalla en lino color crema (ref. ALW).

The base of the floor version is finished in beech wood and lacquered metallic disc, which provides great stability.

Base del modelo de pie acabado en madera de haya y disco metálico lacado, que aporta gran estabilidad.

Includes highly-efficient LED light technology - 130lm/W- and light quality -CRI>80.

Incluye tecnología de iluminación LED de gran eficiencia - 130lm/W- y calidad lumínica -CRI>80.

Its 3000K colour temperature seems warmer when the light filters through the linen.

Los 3000K de temperatura del color, se perciben más cálidos cuando la luz se filtra a través del lino.

For the hanging model, an electrified steel cable system is used.

Para el modelo de suspensión, se utiliza el sistema de cables de acero electrificados.

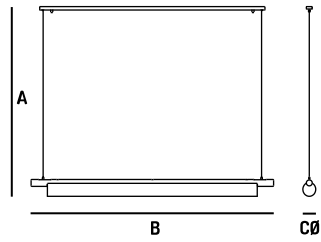

ref	TYPE	A	B	C	D	DIF	BULB	A+
SK.F150	FLOOR LAMP	148cm	Ø8cm	Ø30cm	-	•		LED 24W 24V 3000K 3100lm
SK.S140	PENDANT LAMP	130cm	141cm	Ø8cm	-	•		LED 24W 24V 3000K 3100lm

CE IP20  
 CE IP20

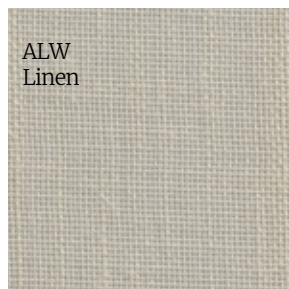



# Nucli

by Joan Genebat



**In NUCLI two fine materials, glass and ceramic,** live in harmony. Both share raw materials and processes; quartz, temperature and many years of history.

Its hand lathing shade transmits the care and nobility of the craftsman. In every line, each one of his decisions is marked forever, creating perfect imperfections.

It contrasts the regular glass sphere that appears from the interior, enhancing its prominence when it emits light and heat.

NUCLI is a timeless piece with different finishes and textures that provide warmth and elegance.

It comes in two diameters: 16 and 27cm, to adapt to the size of any space, whether interior or exterior.

**En NUCLI conviven en armonía dos materiales nobles** vidrio y cerámica. Ambos comparten materia prima y proceso; cuarzo, temperatura y muchos años de historia.

Su pantalla, torneada a mano, transmite el cuidado y nobleza del artesano. En cada trazo, cada decisión suya queda marcada para siempre, creando perfectas imperfecciones.

Contrasta la regular esfera de vidrio que se asoma del interior, realzando su protagonismo cuando emite luz y calor.

NUCLI es una pieza atemporal con diferentes acabados y texturas que aportan calidez y elegancia.

Se presenta en dos diámetros: 16 y 27cm, para adaptarse al tamaño de cualquier espacio, ya sea interior o exterior.



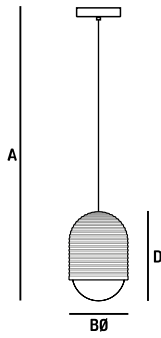

Ceramic shade with slip surrounding, fired at 1040°.

Available in three different shades: blue-grey, clay red and off-white.

Matt opal blown glass sphere diffuser.

The ceiling rosette and the electric cable are black

Available in three or five piece compositions for the 16cm diameter version.

Luminaire suitable for outdoor use. IP54 enclosure.

Includes efficient LED bulb technology.

Pantalla de cerámica con engobe vitrificado, cocida a 1040°.

Disponible en tres tonos diferentes: gris-azulón, arcilla roja y blanco crudo.

Difusor de esfera de vidrio soplado en opal mate.

Florón y cable eléctrico negro.

Se ofrece en composiciones de tres y cinco piezas para la versión de diámetro 16cm.

Luminaria apta para su uso en exteriores. Grado de estanquidad IP54.

Incluye eficiente bombilla de tecnología LED.

ref	TYPE	A	BØ	C	D	DIF	BULB	A+
● NC.S016G	PENDANT LAMP	145cm	16cm	-	24cm	•	1xE27 LED 6W 2700K (included)	
● NC.S016T	PENDANT LAMP	145cm	16cm	-	24cm	•	1xE27 LED 6W 2700K (included)	
○ NC.S016W	PENDANT LAMP	145cm	16cm	-	24cm	•	1xE27 LED 6W 2700K (included)	
● NC.S027G	PENDANT LAMP	160cm	27cm	-	37cm	•	1xE27 LED 14W 2700K (included)	
● NC.S027T	PENDANT LAMP	160cm	27cm	-	37cm	•	1xE27 LED 14W 2700K (included)	
○ NC.S027W	PENDANT LAMP	160cm	27cm	-	37cm	•	1xE27 LED 14W 2700K (included)	

CE IP54

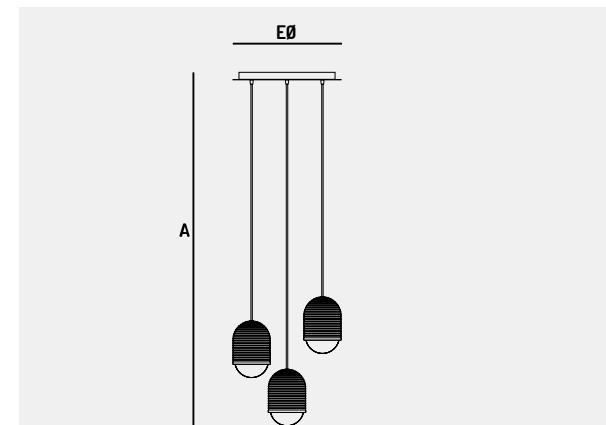
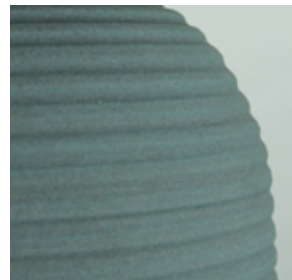

ref	TYPE	A	E	DIF	BULB	A+
● NC.S203G	PENDANT LAMP	145cm	Ø45cm	•	3xE27 LED 6W	
● NC.S203T	PENDANT LAMP	145cm	Ø45cm	•	3xE27 LED 6W	
○ NC.S203W	PENDANT LAMP	145cm	Ø45cm	•	3xE27 LED 6W	

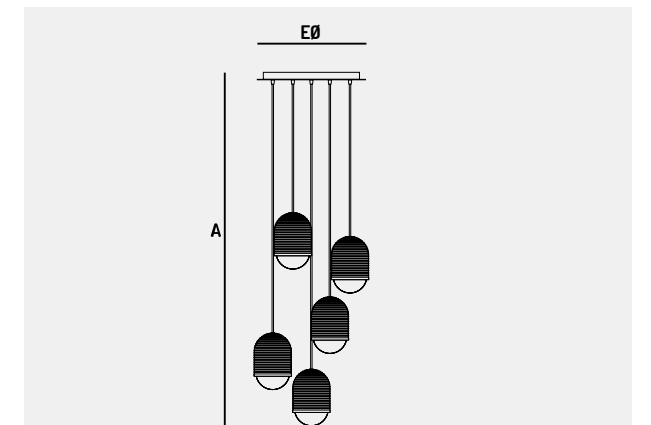

ref	TYPE	A	E	DIF	BULB	A+
● NC.S205G	PENDANT LAMP	145cm	Ø45cm	•	5xE27 LED 6W	
● NC.S205T	PENDANT LAMP	145cm	Ø45cm	•	5xE27 LED 6W	
○ NC.S205W	PENDANT LAMP	145cm	Ø45cm	•	5xE27 LED 6W	

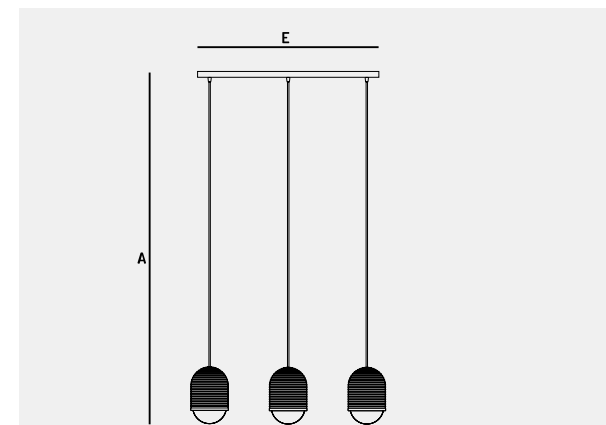

ref	TYPE	A	E	DIF	BULB	A+
● NC.S303G	PENDANT LAMP	145cm	75cm	•	3xE27 LED 6W	
● NC.S303T	PENDANT LAMP	145cm	75cm	•	3xE27 LED 6W	
○ NC.S303W	PENDANT LAMP	145cm	75cm	•	3xE27 LED 6W	

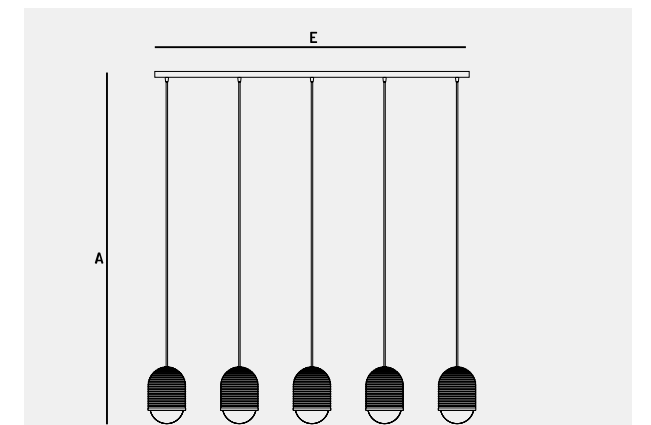

ref	TYPE	A	E	DIF	BULB	A+
● NC.S305G	PENDANT LAMP	145cm	130cm	•	5xE27 LED 6W	
● NC.S305T	PENDANT LAMP	145cm	130cm	•	5xE27 LED 6W	
○ NC.S305W	PENDANT LAMP	145cm	130cm	•	5xE27 LED 6W	



# Plise

by Francesc Crous



**PLISE, as its name suggests, reclaims the folding system to shape the interior hanging luminaries.**

The development of the pleated geometry and its simple folding, allows to combine its large size with a compact and reduced packaging that makes it transport-friendly.

The set of folds that form the conical lampshade, draw a circular matrix of light and shadow on the material.

This characteristic brings uniqueness to the piece, at the same time that it controls and filters the indirect light of its interior.

**PLISE, como su nombre indica, recupera el sistema de pliegues para dar forma a unas luminarias de suspensión de interior.**

El desarrollo de la geometría plisada y su sencillo plegado, permite combinar su gran volumen con un compacto y reducido embalaje que facilita el transporte.

El conjunto de pliegues que forman la pantalla cónica, traza una matriz circular de luz y sombra sobre el material.

Esta característica aporta singularidad a la pieza, a la vez que ordena y tamiza la luz indirecta de su interior.

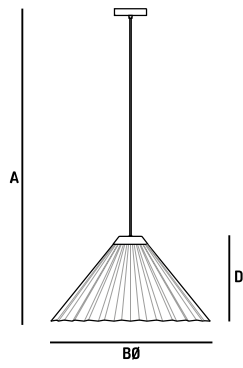

Luminaire with a cotton textile shade and an opaque white PVC acetate interior to improve its light reflection. Textile material available in three finishes: ref. AOB,AOR y AOS.

The shade is fixed between two metallic pieces: inner reflector and exterior trim, lacquered in white (RAL9003). Both provide enough firmness.

White metallic rosette and black silicone cable.

Available in two versions: Integral LED with indirect light projection and an E27 bulb system solution for diffused light. (Bulb not included)

White metallic rosette and black silicone cable

Luminaria con pantalla textil de algodón con un acetato de PVC blanco opaco en el interior para mejorar su reflexión lumínica. Material textil disponible en tres acabados: ref. AOB,AOR y AOS.

La pantalla va fijada entre dos cuerpos metálicos: interior reflector y exterior embellecedor, lacados en blanco (RAL9003). Ambos le aportan la firmeza necesaria.

Florón metálico blanco y cable de silicona negro.

Se presenta en dos versiones de iluminación: LED integral con proyección de luz indirecta y sistema E27 para una luz difusa. (Bombilla no incluida)

Florón metálico blanco y cable de silicona negro

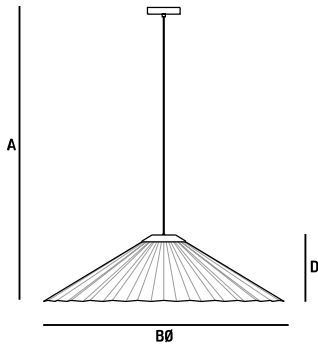

ref	TYPE	A	B	C	D	DIF	BULB	A+
● PL.S060.00B	PENDANT LAMP	155cm	60cm	-	31cm	-	● 1xE27 LED Globe 12W	
● PL.S060.00R	PENDANT LAMP	155cm	60cm	-	31cm	-	● 1xE27 LED Globe 12W	
● PL.S060.00S	PENDANT LAMP	155cm	60cm	-	31cm	-	● 1xE27 LED Globe 12W	
● PL.S060.14B	PENDANT LAMP	155cm	60cm	-	31cm	-	● LED 20W 600mA 3000K 2600lm	
● PL.S060.14R	PENDANT LAMP	155cm	60cm	-	31cm	-	● LED 20W 600mA 3000K 2600lm	
● PL.S060.14S	PENDANT LAMP	155cm	60cm	-	31cm	-	● LED 20W 600mA 3000K 2600lm	
● PL.S090.00B	PENDANT LAMP	145cm	90cm	-	25cm	-	● 1xE27 LED Globe 12W	
● PL.S090.00R	PENDANT LAMP	145cm	90cm	-	25cm	-	● 1xE27 LED Globe 12W	
● PL.S090.00S	PENDANT LAMP	145cm	90cm	-	25cm	-	● 1xE27 LED Globe 12W	
● PL.S090.14B	PENDANT LAMP	145cm	90cm	-	25cm	-	● LED 20W 600mA 3000K 2600lm	
● PL.S090.14R	PENDANT LAMP	145cm	90cm	-	25cm	-	● LED 20W 600mA 3000K 2600lm	
● PL.S090.14S	PENDANT LAMP	145cm	90cm	-	25cm	-	● LED 20W 600mA 3000K 2600lm	

CE IP20

AOB  
Cotton / PVC opaque  
Blue-Gray

AOZ  
Cotton / PVC opaque  
Old Rose

AOS  
Cotton / PVC opaque  
Stone





# Cuca

by Crous Calogero,  
(Francesc Crous and Alessandro Calogero)



**This new outdoor collection, consisting of standing, floor, table and hanging lamps, is characterised by its organic shapes and warmth, defining features of our models.**

The shades in the form of elliptical globes are braided, reminiscent of malacca, with a new neoprene material coated with a fabric suitable for outdoors, while the interior is a large opal triplex glass sphere.

They provide a point of warm light for any outdoor or indoor space.

**Esta nueva colección outdoor, compuesta de pie, suelo, sobremesa y suspensión, se caracteriza por sus formas orgánicas y su calidez, tan propias de nuestros modelos.**

Sus pantallas con forma de globo elíptico se presentan trenzadas, recordando al ratán, con un nuevo material de neopreno recubierto de textil apto para exterior, y en su interior una gran esfera de vidrio triplex opal.

Aportan un punto de luz cálida en cualquier espacio exterior y también interior.

CC.101

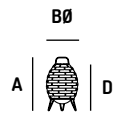

Lights with metal structure treated for outdoors (nanophoresis), painted in grey RAL7032 and braided with UV-treated flecked textile material.

Luminarias de estructura metálica con tratamiento para exterior (nanoforesis), pintada en gris RAL7032 y trenzado con material textil jaspeado tratamiento UV.

CC.102  
CC.103

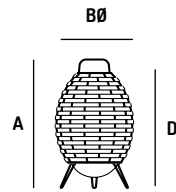

Standing model with stainless steel arm (AISI-304) and grey polyester (RAL7032) finish. White polymer concrete base.

Modelo de pie con brazo de acero inoxidable (AISI-304) acabado en pintura gris (RAL7032) de poliéster. Base en hormigón polímero blanco.

Pendant lamp with fleuron and black neoprene cable.

Colgante con florón y cable neopreno negro.

CC.104

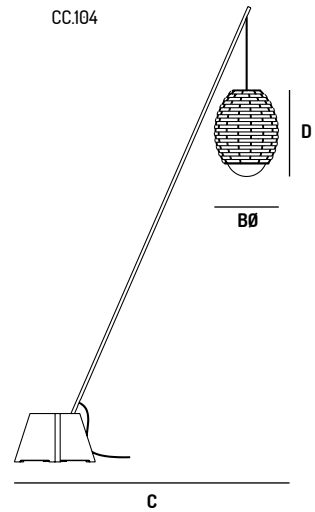

LED bulb included.

Bombilla LED incluida.

A	ref	TYPE	A	BØ	C	D	DIF	BULB A+
	CC.101	TABLE LAMP	32 cm	20 cm	-	28 cm	•	1xE27 LED 6W 2700K (included)
	CC.102	FLOOR LAMP, STANDING	78 cm	50 cm	-	70 cm	•	1xE27 LED 14W 2700K (included)
	CC.103	FLOOR LAMP, STANDING	110 cm	68 cm	-	100 cm	•	1xE27 LED 14W 2700K (included)
	CC.104	FLOOR LAMP, HANGING	270 cm	40 cm	180 cm	50 cm	•	1xE27 LED 14W 2700K (included)
	CC.105	PENDANT LAMP	170 cm	40 cm	-	50 cm	•	1xE27 LED 14W 2700K (included)

CE IP20 CC. 101, CC.102, CC.103  
CE IP20 CC. 104

CC.105

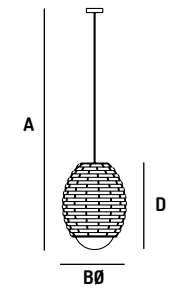







# Cloche

by Joan Genebat



**Cloche evokes memories of the Roaring Twenties.** It is an indoor/outdoor hanging lamp, combining elegance and naturalness.

Made out of locally sourced cork, the LED module is covered with a perforated metal visor in anthracite grey or off white. It also comes with an indoor LED bulb. Decorative and close to nature, for highlighting family and leisure areas.

**Cloche nos evoca el recuerdo de esos locos años 20 del siglo pasado.** Es una suspensión indoor/outdoor que combina elegancia y naturalidad.

*Fabricada en corcho autóctono de nuestra zona, cubre su módulo LED con una visera de metal perforado en gris antracita o blanco roto. También se ofrece con bombilla LED para interior. Decorativa y cercana a la naturaleza, realza las zonas de encuentro familiares o de ocio*



36 Cloche



Cloche 37

Hanging lamp made from treated cork and perforated metal sheet with antioxidant treatment (nanophoresis) and polyester paint, available in off white (RAL9001) and anthracite grey (RAL7024). Available with black fabric cable and bulb in the indoor version and neoprene cable and 10 W LED module in the outdoor version.

Lámpara de suspensión fabricada en corcho tratado y chapa metálica perforada con tratamiento antioxidante (nanoforesis) y pintura de poliéster, disponible en blanco roto (RAL9001) y gris antracita (RAL7024). Disponible con cable textil negro y bombilla en la versión indoor o cable neopreno y módulo LED 10 W en la versión outdoor.

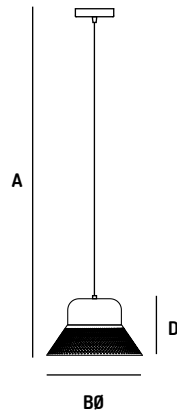

ref	TYPE	A	BØ	C	D	DIF	BULB A+
○ CH.001.00W	PENDANT LAMP	138 cm	30cm	-	18cm		1xE27 LED 12W
● CH.001.00G	PENDANT LAMP	138 cm	30cm	-	18cm		1xE27 LED 12W
○ CH.101.14W	PENDANT LAMP	138 cm	30cm	-	18cm	•	LED 10W 230V 2700K 850lm Dimmable TRIAC
● CH.101.14G	PENDANT LAMP	138 cm	30cm	-	18cm	•	LED 10W 230V 2700K 850lm Dimmable TRIAC

CE IP20 CH.001.00W, CH.001.00G  
 CE IP54 CH.101.00W, CH.101.00G





# Quadra

by Roger Vancells



**Quadra is a collection in a minimalist, rational style.** Its design seeks a harmonious combination of materials and their relation to light as the main leitmotiv. Design, functionality and practicality are blended in this line of two types of lamp: table and wall.

Designed for public and transit areas, it is made with a metal structure, beech wood and a washable textile shade. The purity of its lines makes it the ideal complement for all decorative styles.

**Quadra es una colección de confección minimalista y líneas racionales.** Su diseño propone la convivencia entre diversos materiales y su relación con la luz como principal leitmotiv. Diseño, funcionalidad y la practicidad se funden en esta línea de dos luminarias: sobremesa y aplique.

Ideada para espacios públicos y de tránsito, está hecha de estructura metálica, madera de haya y pantalla textil lavable. Sus líneas puras la convierten en el complemento ideal de cualquier estilo decorativo.



42 Quadra



Quadra 43



44 Quadra

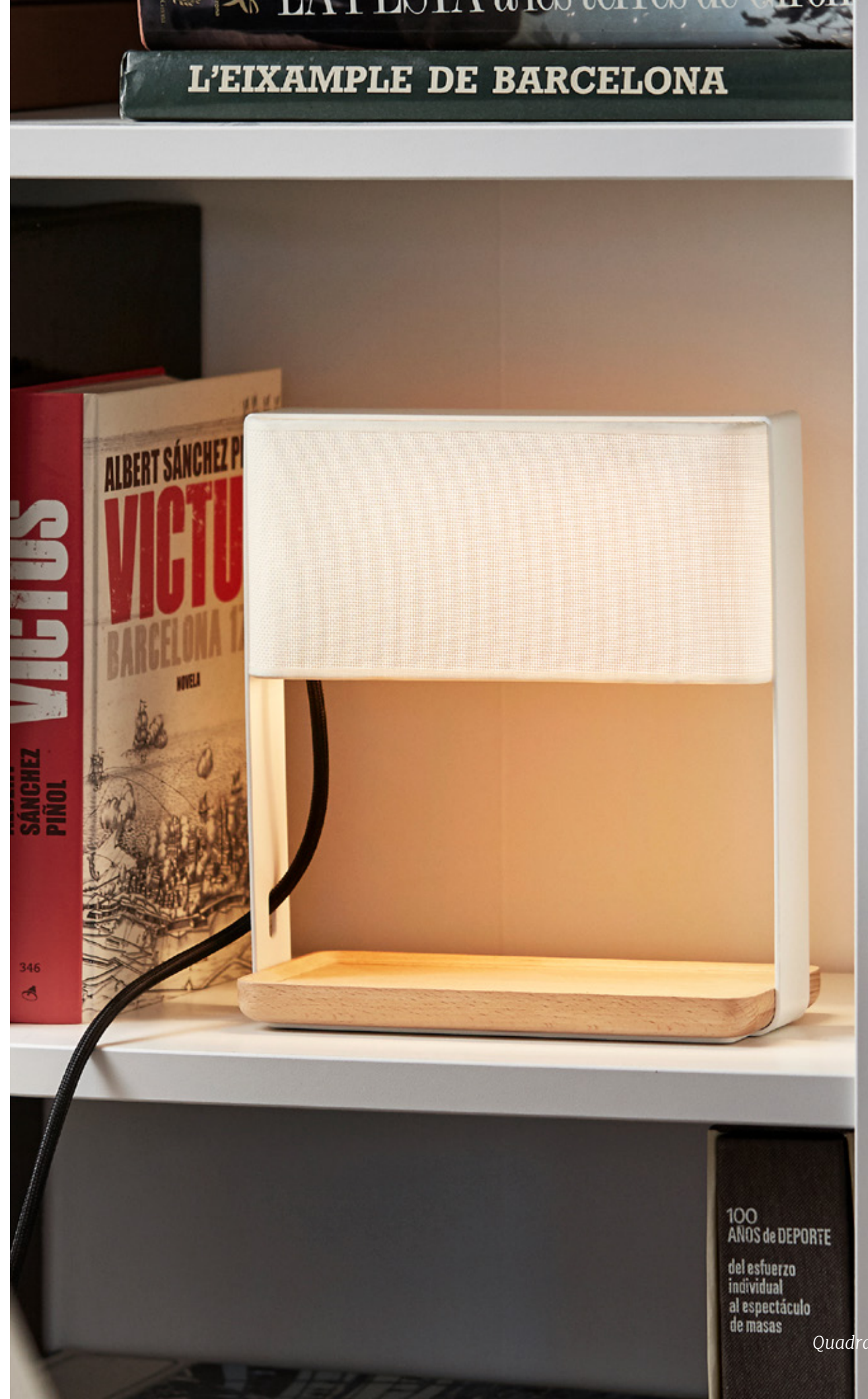

Quadra 45

Table lamp with metal structure and shade in technical fabric, Available in black or white opaque screen. Beech wood with a matt finish. LED lighting system.

*Sobremesa con estructura metálica y pantalla en tejido técnico screen, disponible en screen opaco en blanco o negro. Madera de haya acabado mate. Sistema de iluminación LED.*

Wall lamp with metal structure and shade in technical fabric, available in black or white. Beech wood with a matt finish. LED lighting system..

*Aplique con estructura metálica y pantalla en tejido técnico screen, disponible en blanco o negro. Madera de haya acabado mate. Sistema de iluminación LED.*

Also available in linen and cotton Group A material.

*Tambien disponible en material lino y algodón Grupo A*

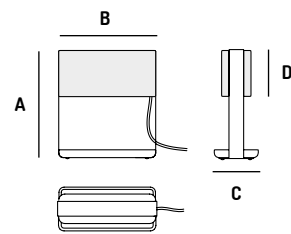
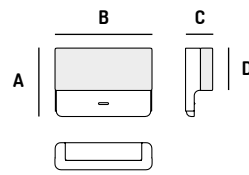

ref	TYPE	A	B	C	D	DIF	BULB	A+
● QD.001.14N	TABLE LAMP	24 cm	21,5 cm	9,5 cm	10 cm	•	LED 4,5W 230V 2700K 370lm	
○ QD.001.14W	TABLE LAMP	24 cm	21,5 cm	9,5 cm	10 cm	•	LED 4,5W 230V 2700K 370lm	
● QD.002.14N	WALL LAMP with switch	15 cm	21 cm	6,5 cm	9 cm	•	LED 4,5W 230V 2700K 370lm	
○ QD.002.14W	WALL LAMP with switch	15 cm	21 cm	6,5 cm	9 cm	•	LED 4,5W 230V 2700K 370lm	
● QD.003.14N	WALL LAMP without switch	15 cm	21 cm	6,5 cm	9 cm	•	LED 4,5W 230V 2700K 370lm Dimmable TRIAC	
○ QD.003.14W	WALL LAMP without switch	15 cm	21 cm	6,5 cm	9 cm	•	LED 4,5W 230V 2700K 370lm Dimmable TRIAC	

CE IP20 QD.001.14N, QD.001.14W

CE IP20 QD.002.14N, QD.002.14W, QD.003.14N, QD.003.14W

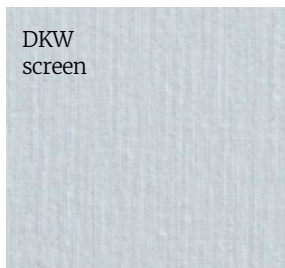
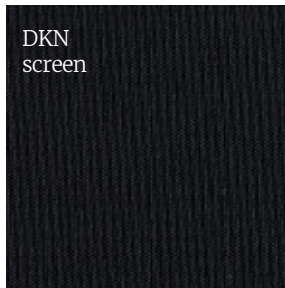





# Twice

by Crous Calogero,  
(Francesc Crous and Alessandro Calogero)



**Discreet and minimalist, a comfortable wall lamp** that provides light for reading, ease of movement, and a soft arc of light, essential for preparing to rest.

This two-in-one lighting accessory offers a choice of colour and texture for the shade that best adapts to the ambience.

**Discreto y minimalista, es un cómodo aplique** que proporciona luz directa para la lectura, y con un sencillo movimiento, su suave arco de luz esencial prepara para el descanso.

Este accesorio lumínico dos en uno permite elegir la pantalla del color y la textura que mejor se adapte al ambiente.

Wall lamp with a lacquered metal structure in white and shade available in any material in group A. 360° adjustable LED light source. Switch and integrated USB charger socket.

*Aplique con estructura metálica lacada en blanco y pantalla disponible en cualquier material grupo A. Fuente de luz LED orientable 360°. Interruptor y salida de cargador USB integradas.*

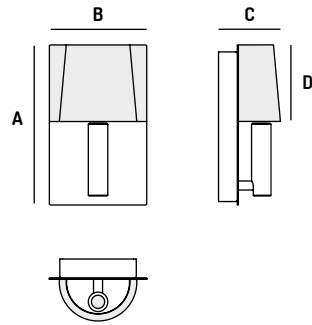

ref	TYPE	A	BØ	C	D	DIF	BULB	A+
TW.001.14	WALL LAMP	23 cm	14 cm	9 cm	11 cm		LED 1,5W 500mA 2700K 180lm	
CE   IP20								

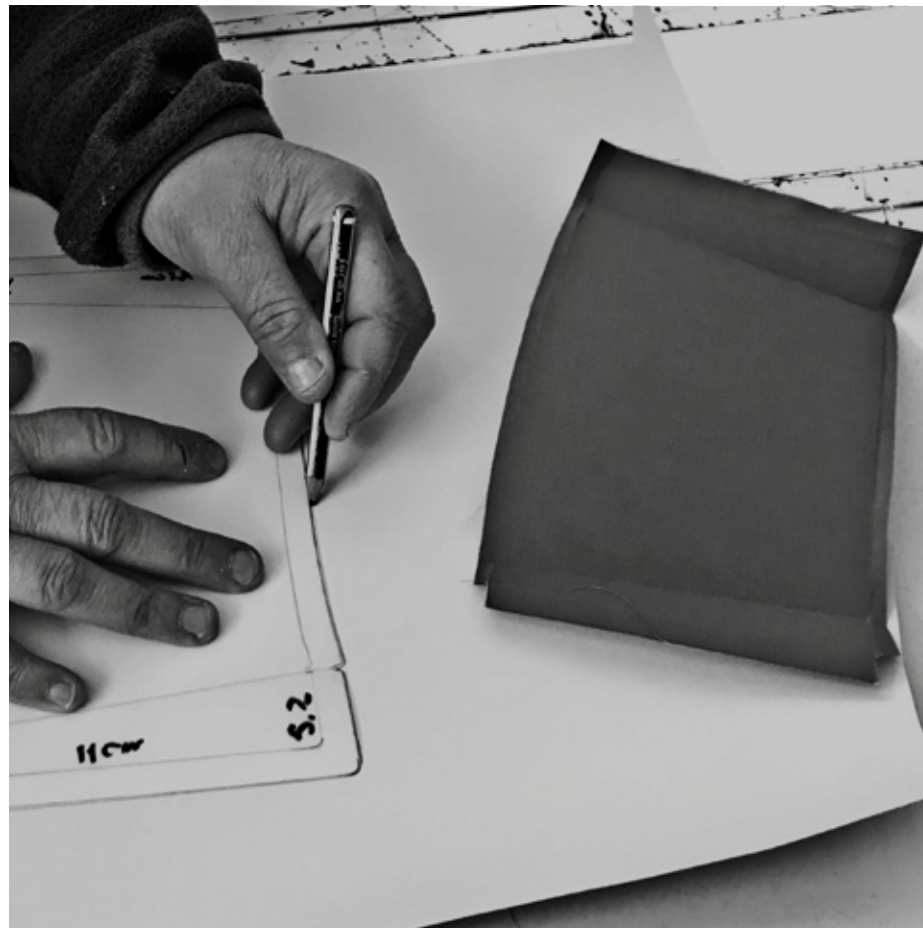
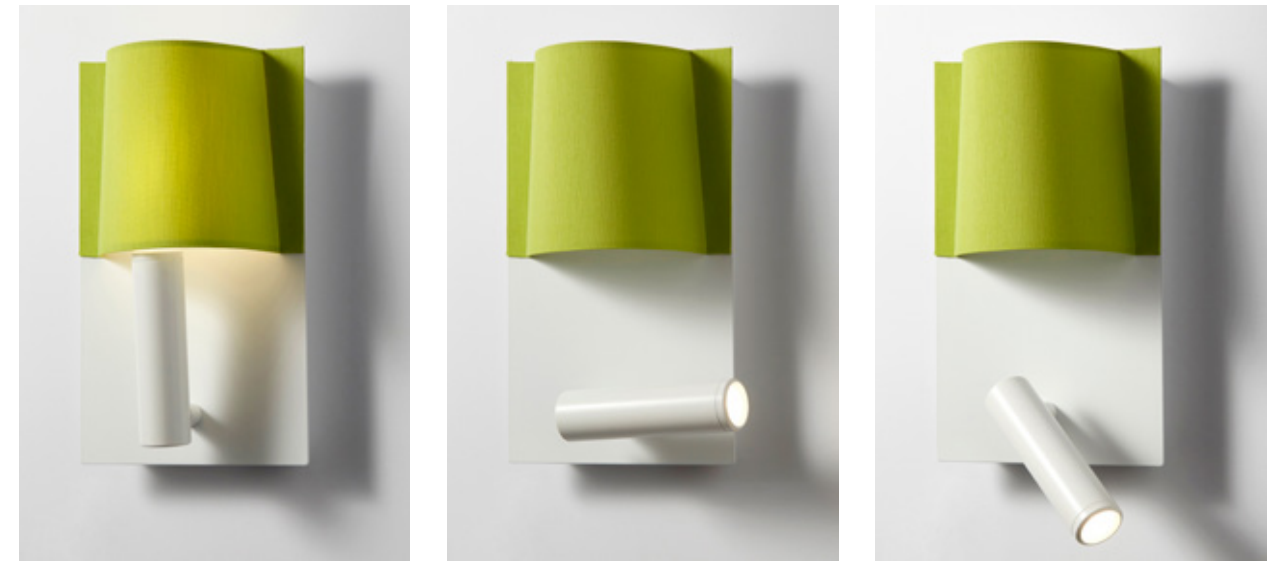

Materials



Group A  
*Grupo A*

	<b>AAC</b> Cotton <i>Algodón</i>		<b>AAN</b> Cotton <i>Algodón</i>
	<b>AAT</b> Cotton <i>Algodón</i>		<b>ACR</b> Cotton <i>Algodón</i>
	<b>ALB</b> Cotton <i>Algodón</i>		<b>AGO</b> Cotton <i>Algodón</i>
	<b>ACA</b> Linen <i>Lino</i>		<b>ALG</b> Linen <i>Lino</i>

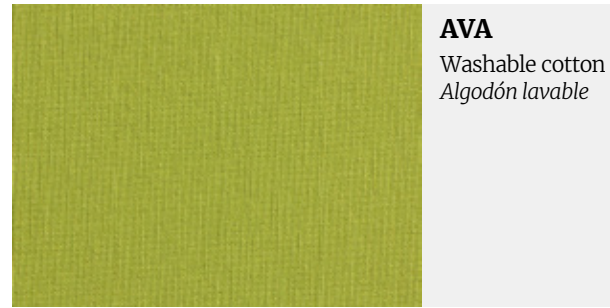

**AVA**  
Washable cotton  
*Algodón lavable*

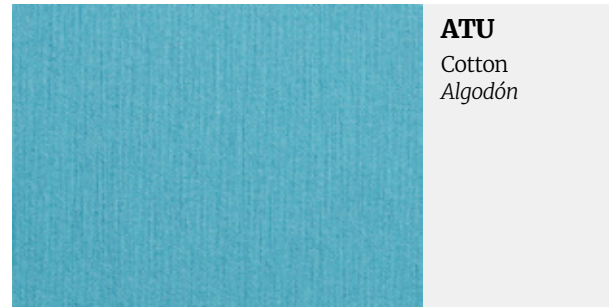

**ATU**  
Cotton  
*Algodón*



**AOB**  
Cotton / PVC  
opaque  
*Algodón / PVC  
opaco*



**AOZ**  
Cotton / PVC  
opaque  
*Algodón / PVC  
opaco*

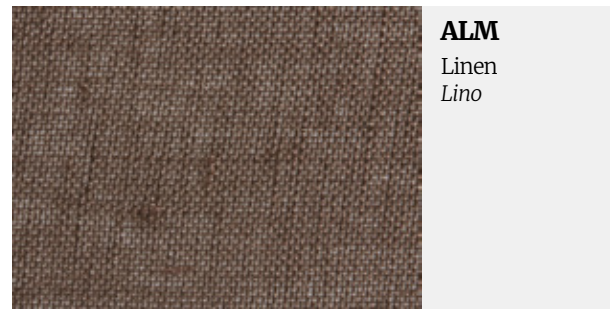

**ALM**  
Linen  
*Lino*

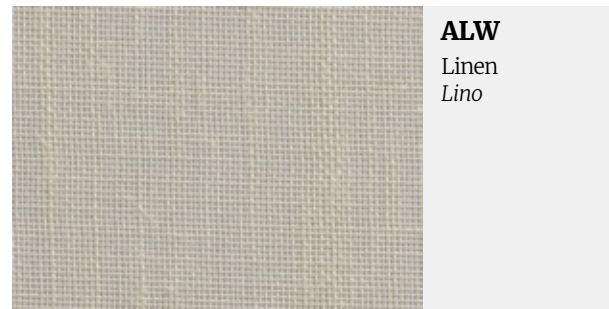

**ALW**  
Linen  
*Lino*

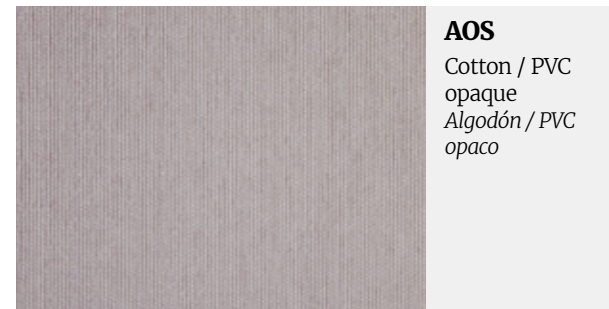

**AOS**  
Cotton / PVC  
opaque  
*Algodón / PVC  
opaco*

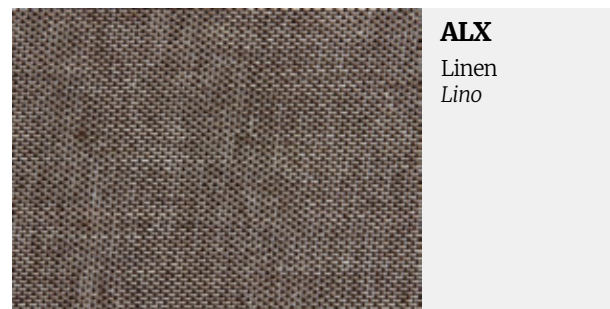

**ALX**  
Linen  
*Lino*

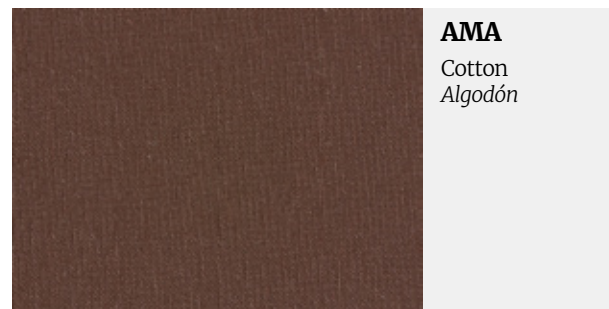

**AMA**  
Cotton  
*Algodón*

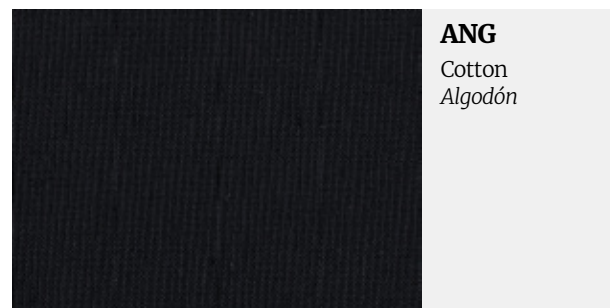

**ANG**  
Cotton  
*Algodón*

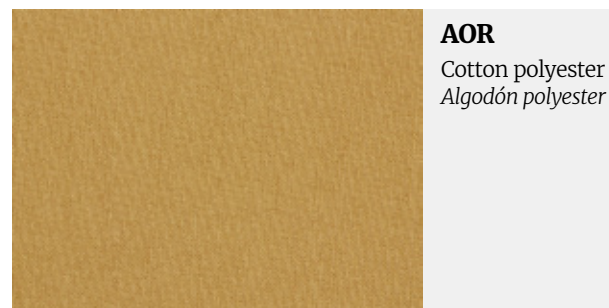

**AOR**  
Cotton polyester  
*Algodón polyester*

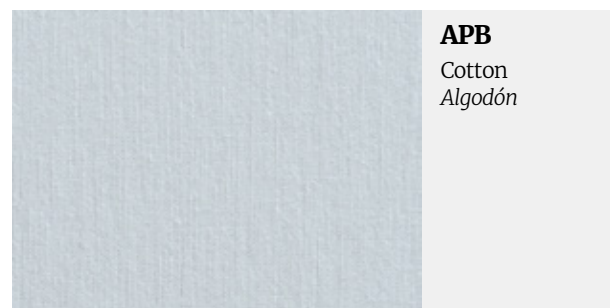

**APB**  
Cotton  
*Algodón*

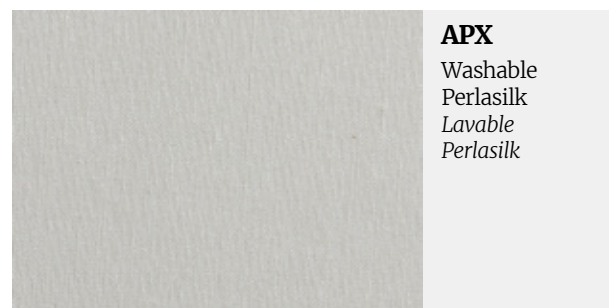

**APX**  
Washable  
Perlasilk  
*Lavable  
Perlasilk*

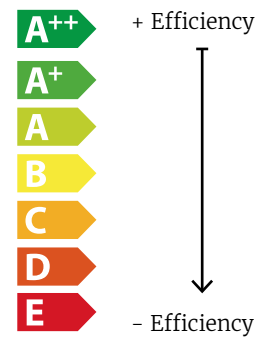

The energy efficiency categories include several types of lamp for reference purposes. Due to a rapidly changing market and the differences between manufacturers we use energy efficiency categories as a guide.

*Los intervalos incluyen varias categorías de lámparas como referencia. Debido a los rápidos cambios en el mercado y las diferencias entre fabricantes, utilizamos intervalos como guía.*

All El Torrent Il·luminació, sl. products are manufactured according to European regulations UNE-EN 60598-1:2015

*Todos los productos de El Torrent Il·luminació, S.L. están fabricados siguiendo las normativas europeas UNE-EN 60598-1:2015.*

The main part of collection are ETL listed.

La mayoría de las colecciones cumplen la normativa ETL

El Torrent Il·luminació, SL. reserves the right to make any changes it believes are beneficial to the end product and are in the client's interests. The content of this catalogue is copyright protected.

*El Torrent Il·luminació, S.L. se reserva el derecho de hacer los cambios que considere oportunos en beneficio del producto final y del cliente. Todo el contenido de este catálogo está protegido por derechos de autor y copyright.*

Total or partial reproduction of the images, text, illustrations, and graphic designs included this catalogue is categorically forbidden without the express authorization of El Torrent Il·luminació, SL.

*Queda terminantemente prohibida la reproducción total o parcial de las imágenes, textos, ilustraciones y conceptos gráficos sin autorización expresa de El Torrent Il·luminació, S.L.*



**Design Diseño**  
www.cel-lula.com - www.studidf.com

**Photography Fotografía**  
starpestudi.com



el**torrent**

EL TORRENT IL·LUMINACIÓ

Carreró,8. 17830 Mieres, Girona. Spain  
T.+34 972 682 037 T.+34 972 680 291

[www.eltorrent.com](http://www.eltorrent.com) [eltorrent@eltorrent.com](mailto:eltorrent@eltorrent.com)