

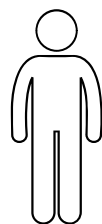

15 min



x2



x2

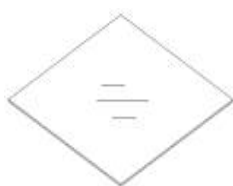

(1) x1

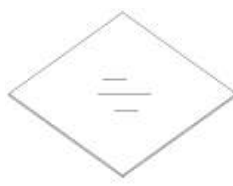

(2) x1



(3) x2



(4) x4



A x8



B x8

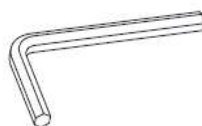

C x1

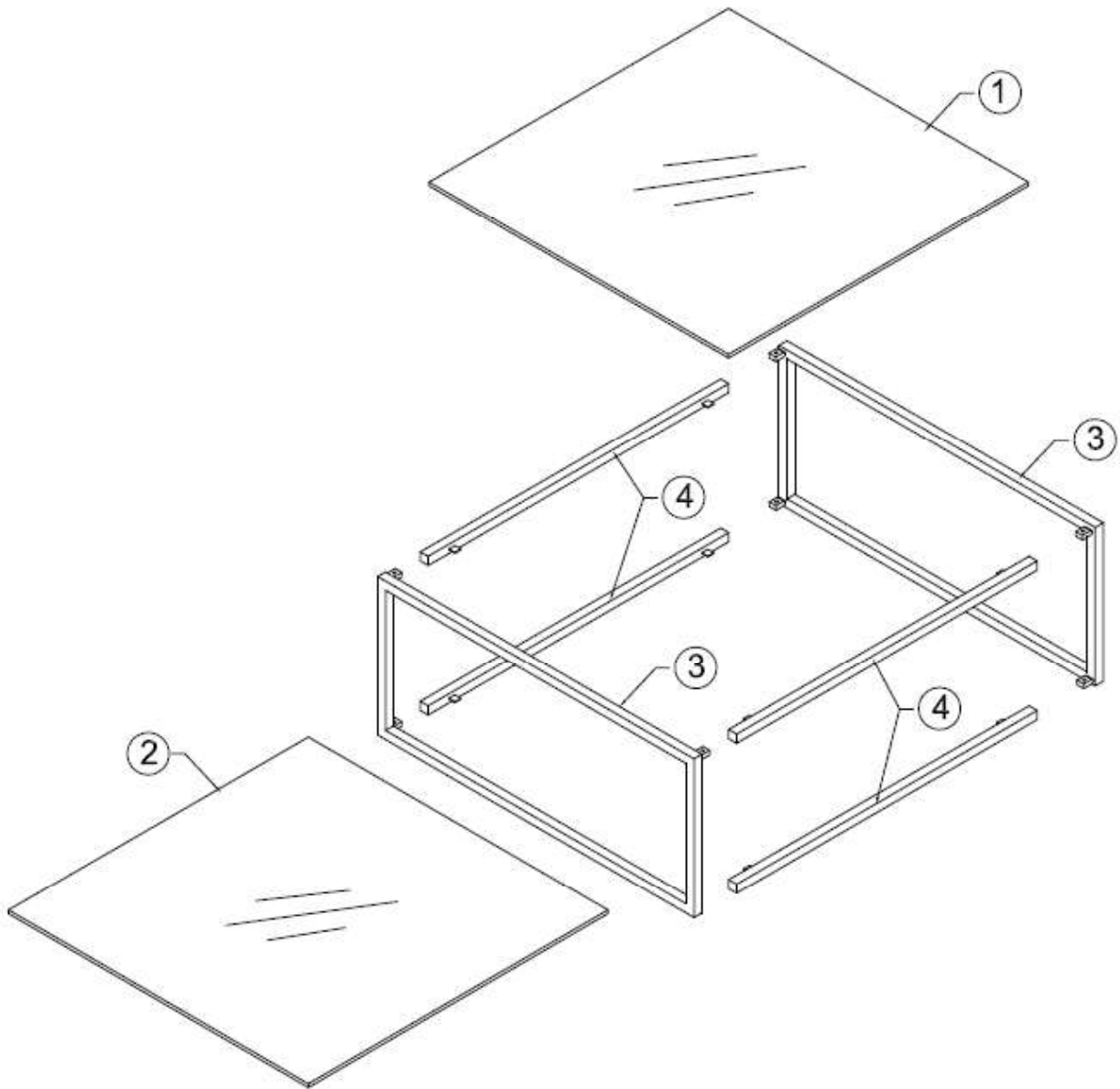



1

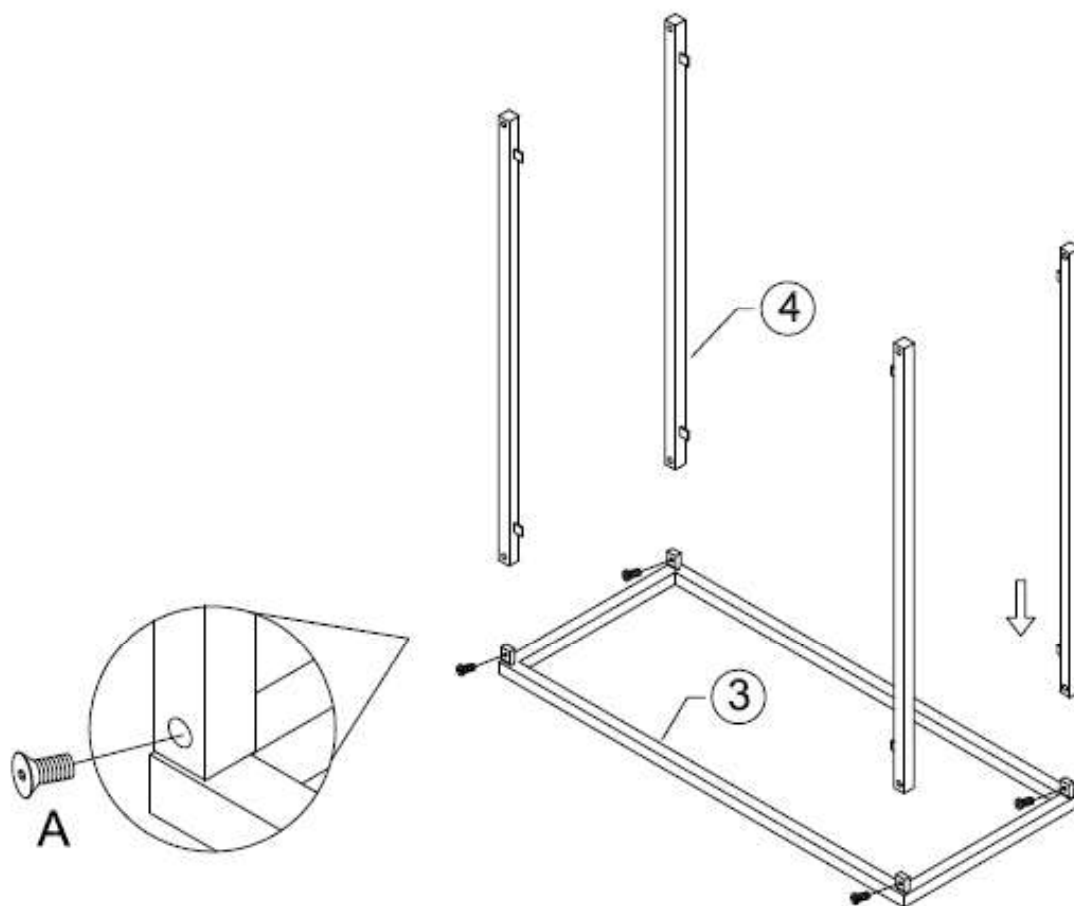



2

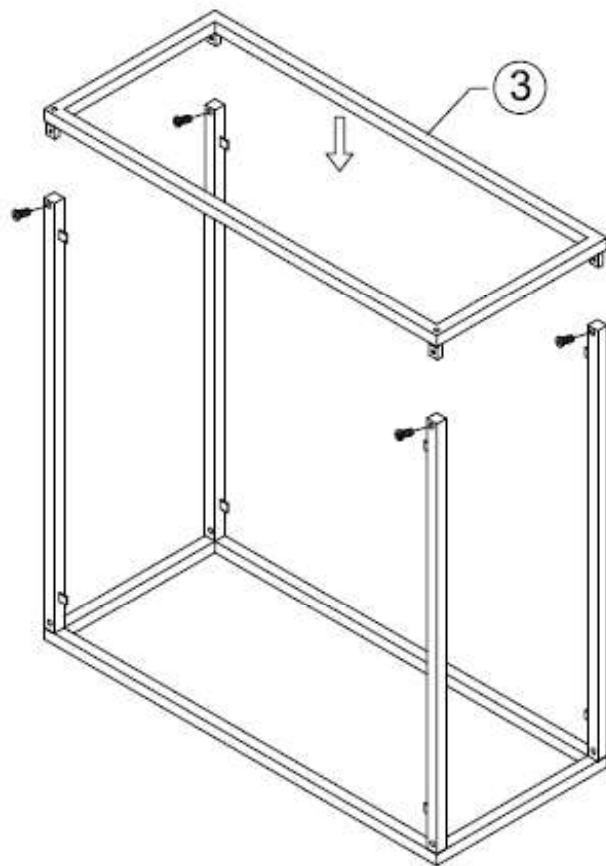
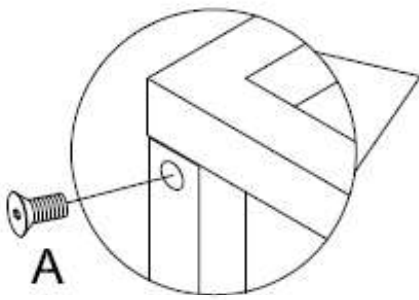



3

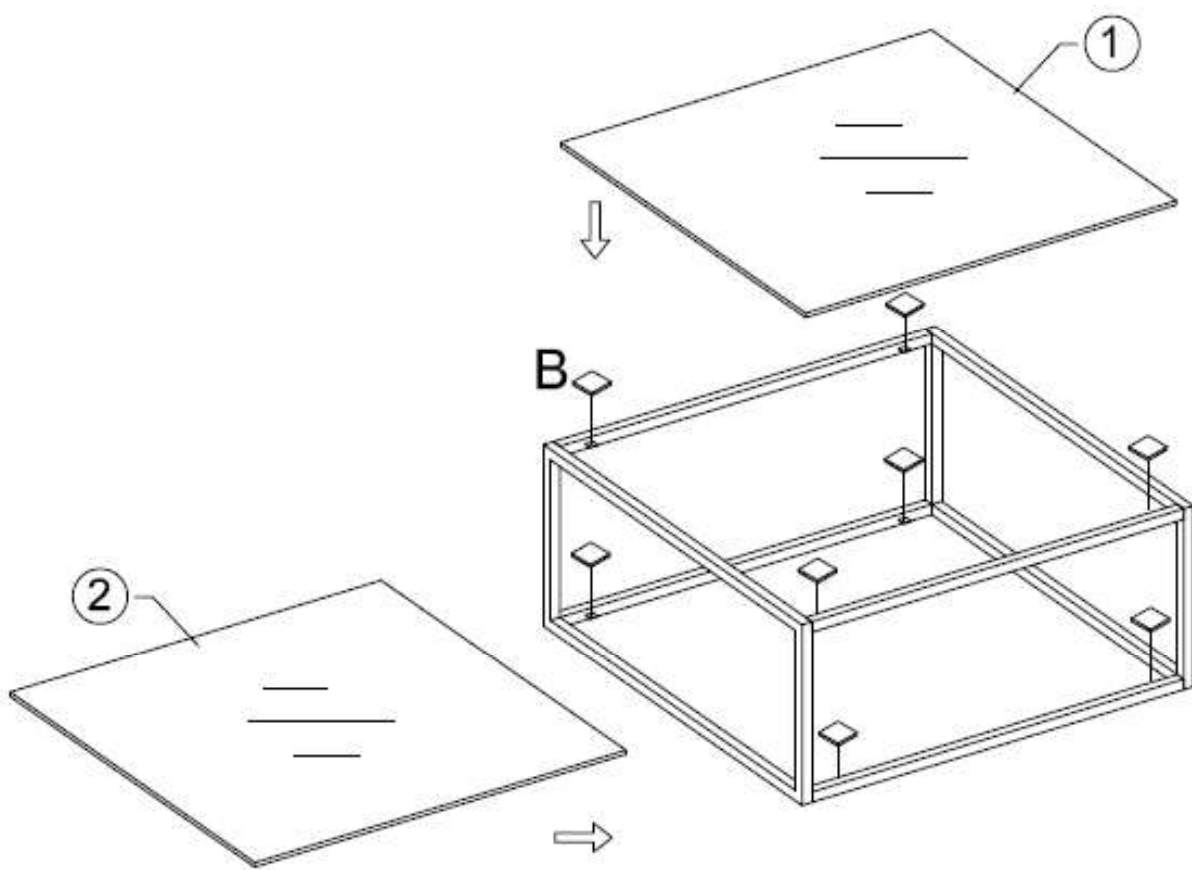

**JULIÀ GRUP Furniture Solutions S.L.**

B-17616277

Pol. Ind. Bosc d'en Cuca

C / Tallers, 14

17410 Sils SPAIN

[contact@kavehome.com](mailto:contact@kavehome.com)