

CIRC

T-3815R / T-3815S

suspension lamp

Date	Type
Project	
Location	
Model #	Quantity
Specifier	

Description

Metallic ceiling light providing direct and indirect light. Shade is made of a satinated glass. Adjustable height. Possibility to create different compositions. False ceiling for recessed canopy is required Ø 45mm drill.

T-3815R	CE	⚡	IP 20	96°
T-3815S	CE	⚡	IP 20	96°



Pictures above might not show the specified dimensions or material. They are for illustration purposes only.

Ordering information

Code	Lamp	Canopy	Finish ring
T-3815R  Ø 45mm drill on dry wall	LED 4x6,1W (led included) F (2700K / Ang 120° / >90 CRI / 350mA) / 230V / Typ* 4x565 lumens Dimmable Triac / Remote driver / Glass shade	26 BLK Black	26 BLK Black 61 S GLD Satin Gold CUSTOM
T-3815S	LED 4x6,1W (led included) F (2700K / Ang 120° / >90 CRI / 350mA) / 230V / Typ* 4x565 lumens Dimmable Triac / Glass shade	26 BLK Black	26 BLK Black 61 S GLD Satin Gold CUSTOM

Product includes

Code	Description
113820263	1 round recessed canopy (only included in T-3815R)
113815263	1 round canopy (only included in T-3815S)
T-3815	1 Circ suspension
671000043	2 drivers / Dimmable Triac

T-3815R with recessed canopy R12

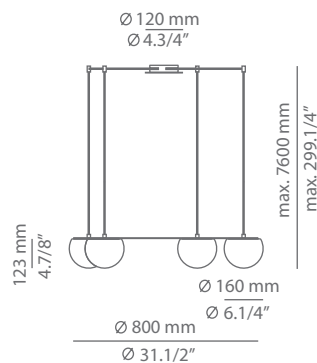

T-3815S with canopy R30

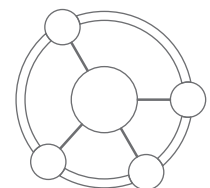
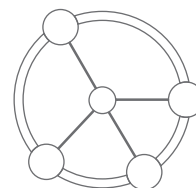
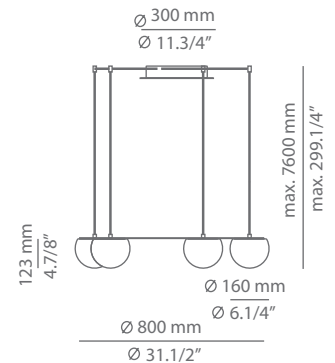

SPECIAL REQUIREMENTS

Custom versions

We offer custom plated or RAL finishes. Alternate lamping and sizes available for projects. Consult our offices.

Special instructions

CIRC

T-3816R / T-3816S

suspension lamp

Date	Type
Project	
Location	
Model #	Quantity
Specifier	

Description

Metallic ceiling light providing direct and indirect light. Shade is made of a satinated glass. Adjustable height. Possibility to create different compositions. False ceiling for recessed canopy is required Ø 45mm drill.











T-3816R   

T-3816S   



Pictures above might not show the specified dimensions or material. They are for illustration purposes only.

Ordering information

Code	Lamp	Canopy	Finish ring
 T-3816R  Ø 45mm drill on dry wall	LED 7x6,1W (led included)  (2700K / Ang 120° / >90 CRI / 350mA) / 230V / Typ* 7x565 lumens Dimmable Triac / Remote driver / Glass shade	26 BLK Black	 26 BLK Black  61 S GLD Satin Gold  CUSTOM
 T-3816S	LED 7x6,1W (led included)  (2700K / Ang 120° / >90 CRI / 350mA) / 230V / Typ* 7x565 lumens Dimmable Triac / Glass shade	26 BLK Black	 26 BLK Black  61 S GLD Satin Gold  CUSTOM

Product includes

Code	Description
113820263	1 round recessed canopy (only included in T-3816R)
113815263	1 round canopy (only included in T-3816S)
T-3816	1 Circ suspension
671000034	1 driver / Dimmable Triac
671000043	2 drivers / Dimmable Triac

T-3816R with recessed canopy R12

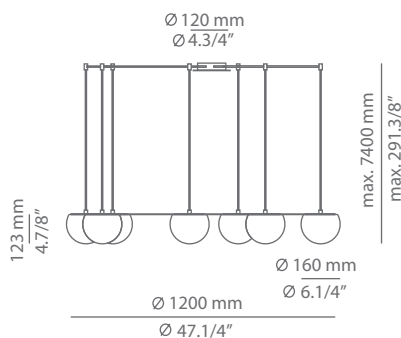

T-3816S with canopy R30

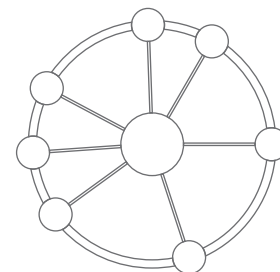
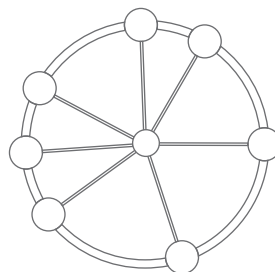
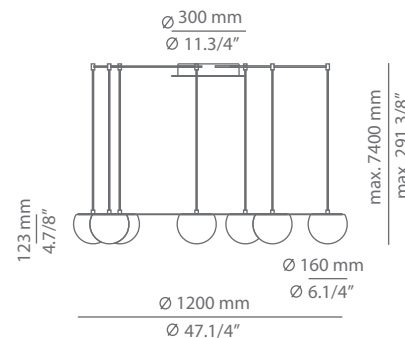

SPECIAL REQUIREMENTS

Custom versions

We offer custom plated or RAL finishes. Alternate lamping and sizes available for projects. Consult our offices.

Special instructions

CIRC

T-3815R / T-3816R

suspension lamp

Date	Type
Project	
Location	
Model #	Quantity
Specifier	

Many possible configurations with T-3815R and T-3816R

See CIRC T-3815A / T-3816A spec sheet for combinations with acoustic panels.

See CIRC T-3810 / T-3811 spec sheet for combinations with ceiling lights.

Code	Composition includes
<p>R12.1SP1MP</p> <p>circ composition</p>  <p>Ø 45mm drill on dry wall</p>	<p>1 round recessed canopy 113820263</p> <p>1 unit of T-3815</p> <p>1 unit of T-3816</p> <p>1 remote driver 671000034 / Dimmable Triac</p> <p>4 remote drivers 671000043 / Dimmable Triac</p>

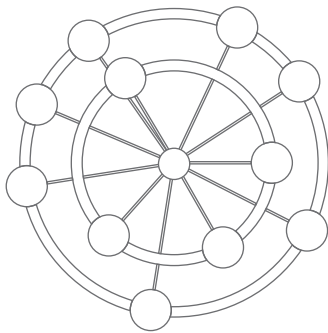

Finish canopy
26 BLK Black
Finish body
26 BLK Black
61 S GLD Satin Gold
CUSTOM

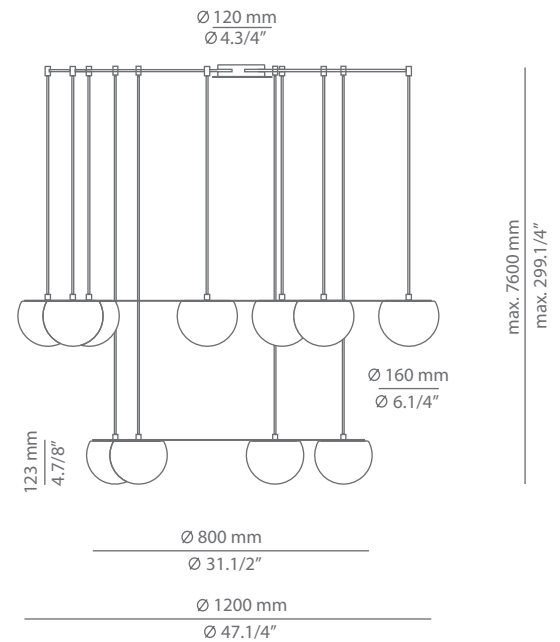

Code	Composition includes
<p>R12.2SP1MP</p> <p>circ composition</p>  <p>Ø 45mm drill on dry wall</p>	<p>1 round recessed canopy 113820263</p> <p>2 unit of T-3815</p> <p>1 unit of T-3816</p> <p>1 remote driver 671000034 / Dimmable Triac</p> <p>6 remote drivers 671000043 / Dimmable Triac</p>

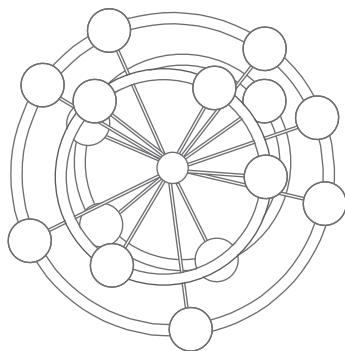

Finish canopy
26 BLK Black
Finish body
26 BLK Black
61 S GLD Satin Gold
CUSTOM

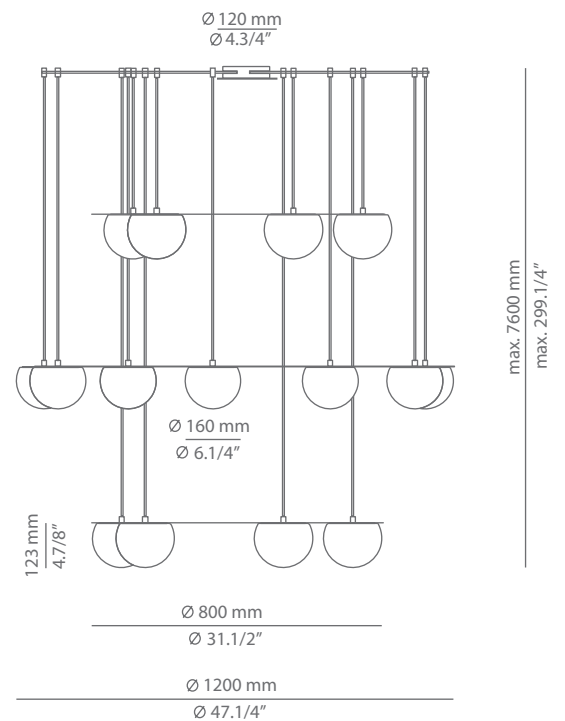

CIRC

T-3815S / T-3816S

suspension lamp

Date	Type
Project	
Location	
Model #	Quantity
Specifier	

Many possible configurations with T-3815S and T-3816S

See CIRC T-3815A / T-3816A spec sheet for combinations with acoustic panels.

See CIRC T-3810 / T-3811 spec sheet for combinations with ceiling lights.

Code	Composition includes
R30.1SP1MP circ composition	1 round canopy 113815263 1 unit of T-3815 1 unit of T-3816 1 driver 671000034 / Dimmable Triac 4 drivers 671000043 / Dimmable Triac

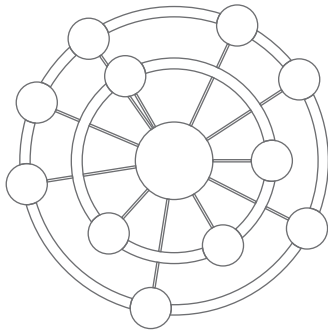

Finish canopy	
26 BLK	Black
Finish body	
26 BLK	Black
61 S GLD	Satin Gold
CUSTOM	

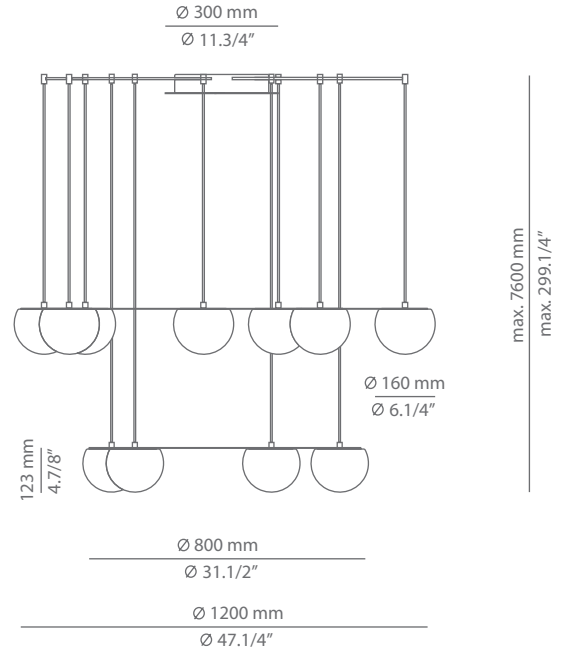

Code	Composition includes
R30.2SP1MP circ composition	1 round canopy 113815263 2 unit of T-3815 1 unit of T-3816 1 driver 671000034 / Dimmable Triac 6 drivers 671000043 / Dimmable Triac

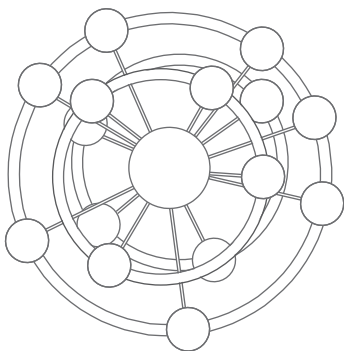

Finish canopy	
26 BLK	Black
Finish body	
26 BLK	Black
61 S GLD	Satin Gold
CUSTOM	

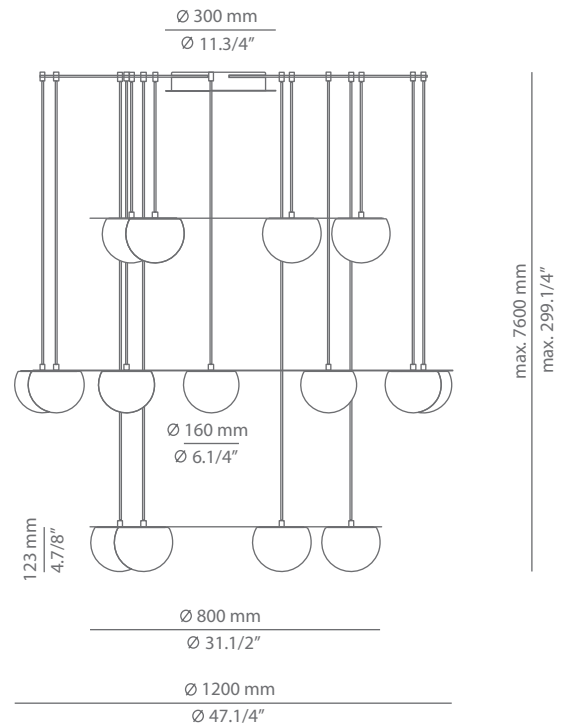

CIRC

T-3815 / t-3811
suspension lamp / ceiling light

Date	Type
Project	
Location	
Model #	Quantity
Specifier	

Many possible configurations with T-3815 and t-3811

See CIRC T-3815A / T-3816A spec sheet for combinations with acoustic panels.

See CIRC t-3810 / t-3811 spec sheet for more information about Circ t-3811 ceiling light.

Code	Composition includes
<p>■ R12.1SP1MF</p> <p>circ composition</p>  <p>Ø 45mm drill on dry wall</p>	<p>1 round recessed canopy 113820263</p> <p>1 unit of t-3811</p> <p>1 unit of T-3815</p> <p>1 remote driver 671000034 / Dimmable Triac</p> <p>4 remote drivers 671000043 / Dimmable Triac</p>

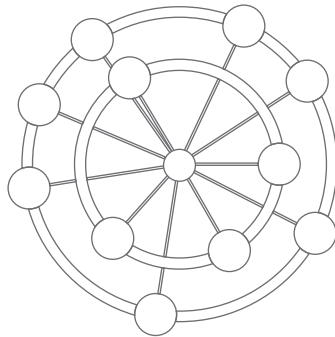

Finish canopy	
26 BLK	Black
Finish body	
■ 26 BLK	Black
■ 61 S GLD	Satin Gold
■ CUSTOM	

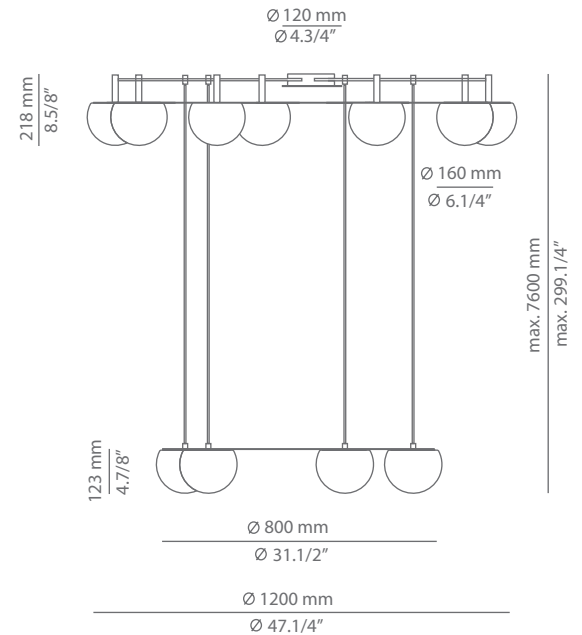

Code	Composition includes
<p>■ R30.1SP1MF</p> <p>circ composition</p>	<p>1 round canopy 113815263</p> <p>1 unit of t-3811</p> <p>1 unit of T-3815</p> <p>1 driver 671000034 / Dimmable Triac</p> <p>4 drivers 671000043 / Dimmable Triac</p>

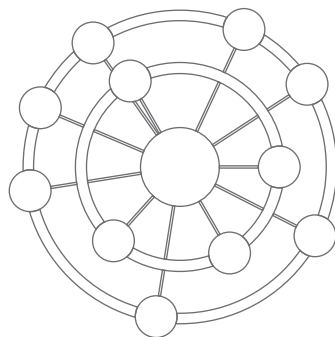

Finish canopy	
26 BLK	Black
Finish body	
■ 26 BLK	Black
■ 61 S GLD	Satin Gold
■ CUSTOM	

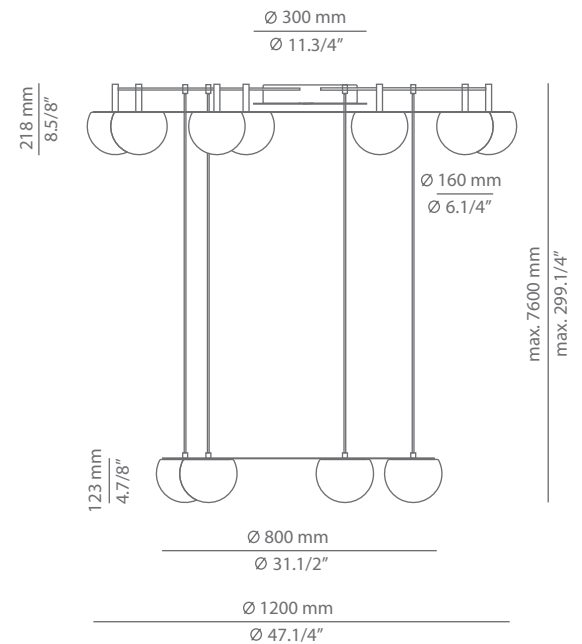

CIRC

T-3816 / t-3810
suspension lamp / ceiling light

Date	Type
Project	
Location	
Model #	Quantity
Specifier	

Many possible configurations with T-3816 and / t-3810

See CIRC T-3815A / T-3816A spec sheet for combinations with acoustic panels.

See CIRC t-3810 / t-3811 spec sheet for more information about Circ t-3810 ceiling light.

Code	Composition includes
R12.1SF1MP	1 round recessed canopy 113820263
circ composition	1 unit of t-3810
	1 unit of T-3816
	1 remote driver 671000034 / Dimmable Triac
	4 remote drivers 671000043 / Dimmable Triac



Ø 45mm
drill on dry wall

Finish canopy

26 BLK Black

Finish body

- 26 BLK Black
- 61 S GLD Satin Gold
- CUSTOM

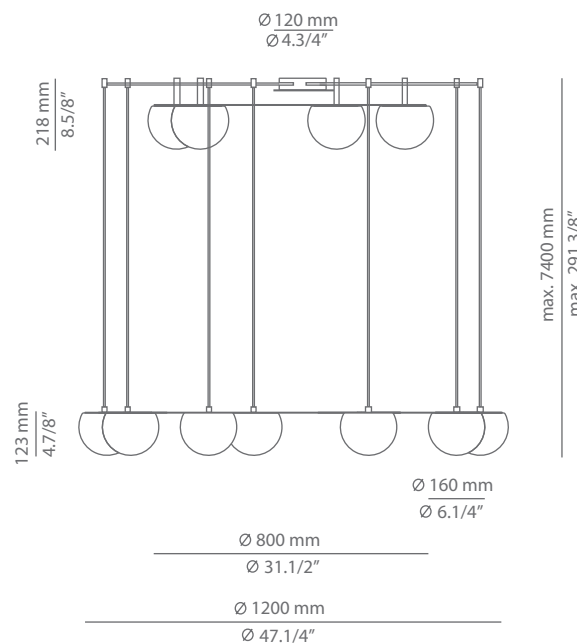
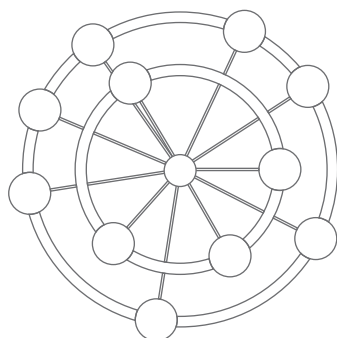

Code	Composition includes
R30.1SF1MP	1 round canopy 113815263
circ composition	1 unit of t-3810
	1 unit of T-3816
	1 driver 671000034 / Dimmable Triac
	4 drivers 671000043 / Dimmable Triac

Finish canopy

26 BLK Black

Finish body

- 26 BLK Black
- 61 S GLD Satin Gold
- CUSTOM

