

## Curvas

ref. **CV04C-3**

Pendant lamp  
Lámpara colgante

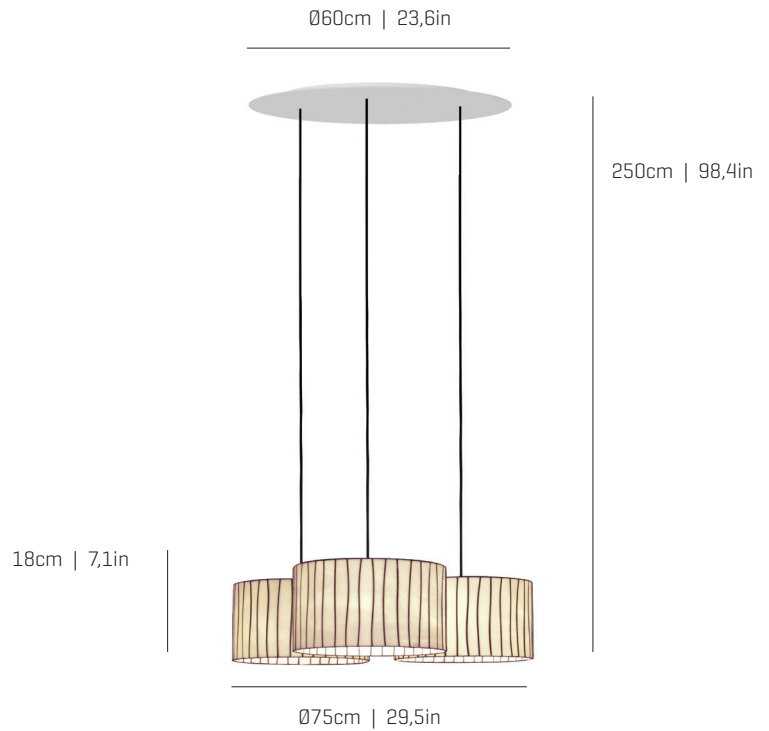

### Curvas Collection

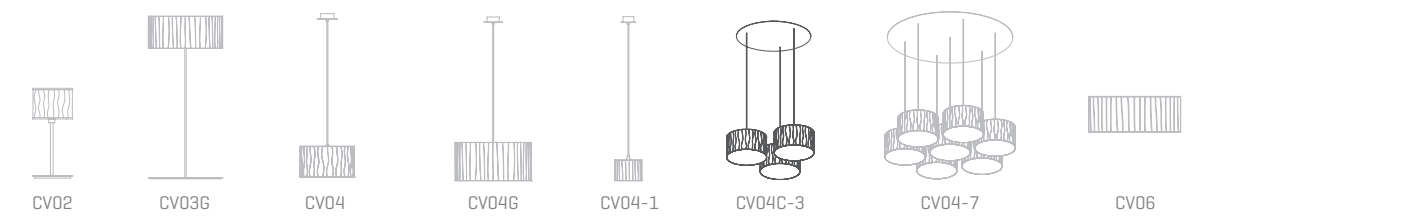

### MATERIAL FINISHES MATERIALES Y ACABADOS

#### LAMPSHADE

##### TULIPA

Glass  
Vidrio

One colour to choose  
Un color a elegir

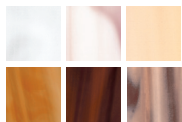

Bottom diffuser  
Difusor inferior

#### CANOPY AND CABLE FLORÓN Y CABLE

DIBOND®

Black or transparent cable  
Cable negro o transparente

### RECOMMENDED BULBS BOMBILLAS RECOMENDADAS

#### 230V - 50Hz

E27 LED Standard- Max. 3x12 W

E27 LED Vintage- Max. 3x12 W

#### 120V - 60Hz

E26 Med. - Max. 3x100 W

#### ENERGY EFFICIENCY EFICIENCIA ENERGÉTICA

from A+ to E  
desde A+ a E

### OTHER TECHNICAL DATA OTROS DATOS TÉCNICOS

#### NET WEIGHT

PESO NETO  
8kg | 17,6lb

#### PACKAGING

EMBALAJE  
60x80x95cm | 23,6x31,5x37,4in  
16kg | 35lb

#### ELECTRICAL FEATURES CARACTERÍSTICAS ELÉCTRICAS



CERTIFICATIONS  
CERTIFICACIONES



# arturo alvarez

emotional light

ASSEMBLY INSTRUCTIONS | INSTRUCCIONES DE MONTAJE

Box contains | Contenido de la caja:

**A** - Lampshade | Tulipas [3]

**B** - Canopy | Florón [1]

**C** - Frame | Soporte [1]

**D** - Cap | Tapón [3]

**E** - Screws | Tornillos [4]

**F** - Wall plug | Tacos [4]

**G** - Electrical disposal | Ficha conexión [1]

ref. **CV04C - 3**

Suitable for indoor use, at 25°C

Apta para uso interior a temperatura ambiente de 25°C

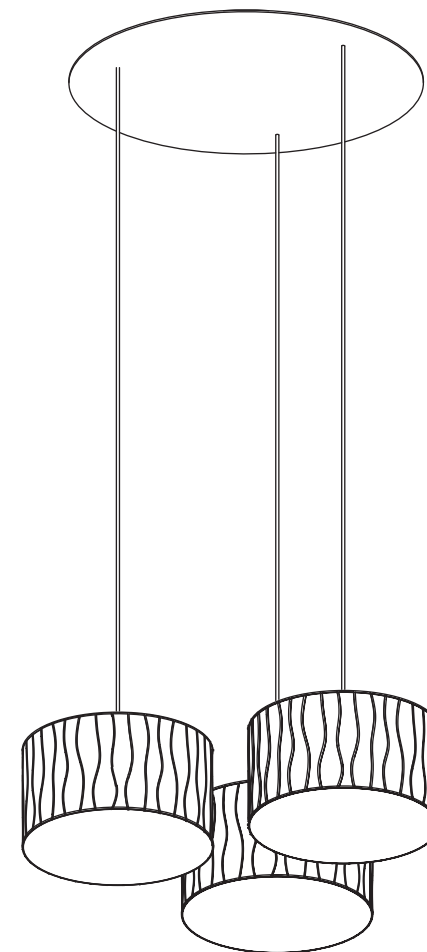
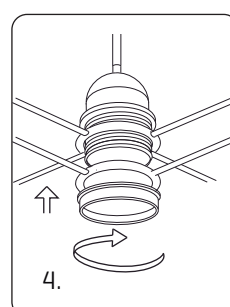
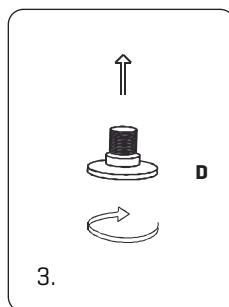
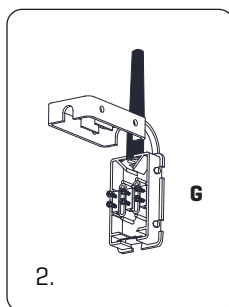
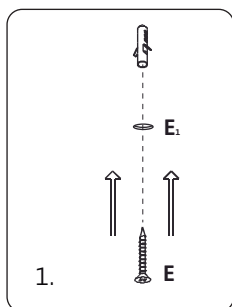
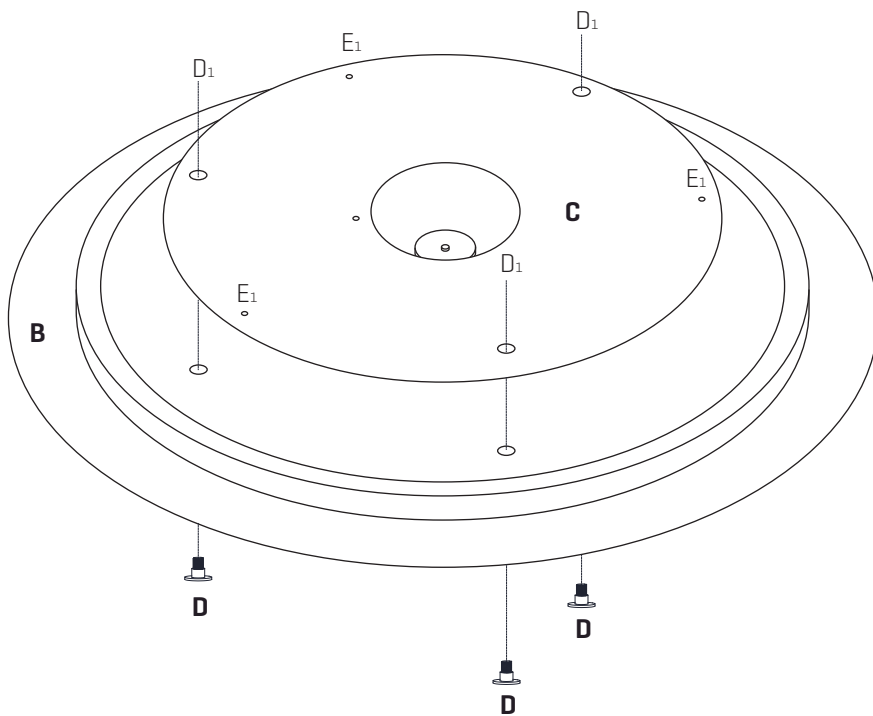

BOTTOM VIEW | VISTA INFERIOR  
POSITION LAMPSHADES | POSICIÓN DE LAS TULIPAS

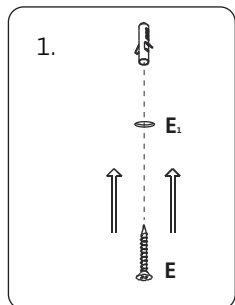

1. Make holes in the ceiling as marked in the frame with the letter E., insert the wall plugs and fix the frame.

\* Our plugs are appropriate for concrete ceilings only

1. Hacer los taladros en su techo según los marcados en el soporte con la letra E., colocar los tacos y fijar el soporte.

\* Nuestros tacos son sólo aptos para superficies de hormigón

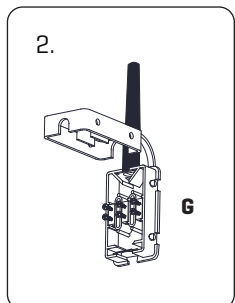

2. Pass the electrical wires inside the electrical disposal G.

The power cables from the wall shouldn't exceed the dimension of the black hose connection box provided, as shown in Fig. 2.1

Make the electrical connections taking care to respect the correct polarity as the color code.

2. Pasar los cables eléctricos al interior de la caja de conexiones G.

Los cables de alimentación procedentes de la pared no deben exceder la dimensión del manguito negro de la caja de conexiones suministrada, tal y como se indica en la figura 2.1

Realizar la conexión eléctrica teniendo cuidado de respetar la polaridad correcta según el código de colores.

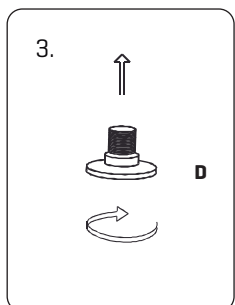
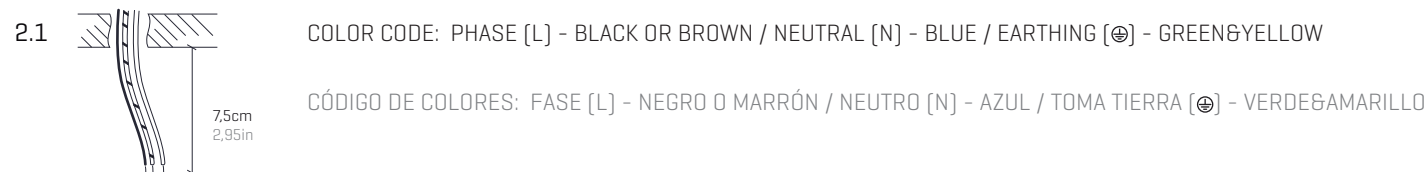

3. Once the frame is fixed, screw the caps in the holes marked with D.

3. Colocado el soporte, enroscar los tapones en los taladros marcados con la letra D.

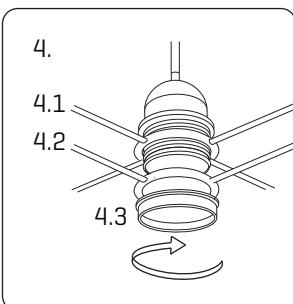

4. All the lampholder are marked with its appropriate lampshade [name].

This reference has an additional accessory for the diffuser, to place correctly the order is as follows:

LAMPSHADE SUPPORT [4.1] - ACCESSORIES SUPPORT [4.2] - NUT [4.3]

4. Todos los portalámparas están marcados con la tulipa correspondiente [nombre].

Este modelo dispone de un accesorio adicional para el difusor, para colocarlo correctamente el orden es el siguiente:

ESQUELETAJE TULIPA [4.1] - ESQUELETAJE ACCESORIO [4.2] - TUERCA [4.3]