

luxcambra

SINCE 1966

More than just lights

luxcambra

SINCE 1966

Índice alfabético
Alphabetical index
Index alphabétique

A

Absis, 24
Acapulco, 56
Ama, 68
Arco, 86
Atlanta, 98

B

Barceloneta, 104
Born, 112

C

Calma, 118
Capuchina, 130
Champignon, 146
Cilindre, 156
Cim, 162
Clipam, 178
Conica, 186
Creta, 196
Cuadro, 200
Corba, 206

D

Dual, 220

F

Fanal, 226

G

Glos, 248

H

H2, 254

I

Indiana, 260

J

Jana, 278

K

Kan, 282
Kea, 320
Kito, 330

L

Line, 338
Lula, 342
Lymington, 350

M

Mad, 356
Manhattan, 364
Matrix, 380
Matrix led, 390
Milos, 396
Miramar, 402
Moon, 410

N

Nautic, 420
Niuet, 424

O

Oita, 440
Oxygen, 446

P

Panama, 454
Parabolica, 458

R

Raval, 464
Rondo, 468
Rum, 476

S

Sarria, 482
Sirius, 494
Sutton, 504

T

Teide, 512
Terra, 516
Thea, 534
Thira, 540
Torso, 544
Toscana, 548

U

Uec, 556
Ufo, 560

Apliques
Wall lamps
Appliques



Absis lector, 44



Absis, 46



Ama, 72



Arco, 91



Atlanta, 101



Capuchina, 133



Champignon, 154



Cim, 168



Corba, 208



Corba U lector, 214



Dual, 222



Glos, 250



Indiana, 267



Kan, 300



Kan lector, 302

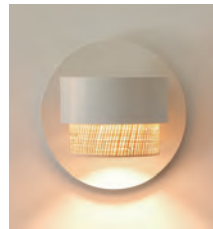

Kan XL, 304



Kea, 324



Kito, 334



Line, 340



Lula, 344



Lymington, 352



Manhattan, 367



Matrix, 385

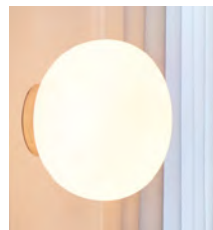

Moon, 416



Niuet, 435



Oita, 442



Panama, 456



Rum, 478



Sirius, 500



Sutton, 507



Teide, 514

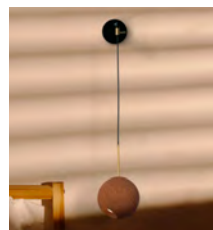

Terra, 523



Torso, 546



Uec, 558

Lámparas de suspensión

Hanging lamps
Suspensions



Absis, 32



Absis lineal, 35



Arcapulco, 58



Ama, 76



Barceloneta, 106



Born, 114



Calma, 121



Capuchina, 138



Champignon, 148



Cim, 164

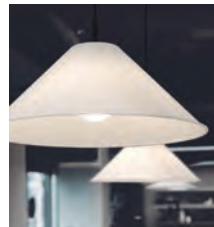

Conica, 188



Creta, 198



Fanal, 238



Indiana, 262



Kan chandelier, 284



Kan XS, 288



Kan lineal, 290



Kan L, 297



Kea, 322



Kito, 333



Lula, 345



Mad, 358



Milos, 398



Miramar, 404



Moon, 414



Niuet XL, 426



Oxygen, 448



Parabolica, 460

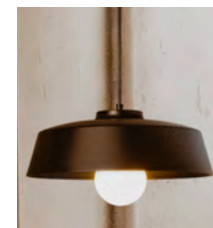

Raval, 466



Sarria, 490



Sirius, 496



Sutton, 506



Terra, 522

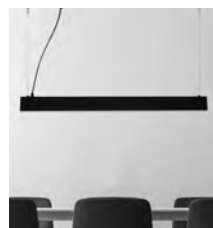

Thira, 542

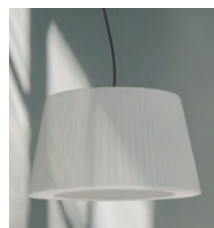

Toscana, 550



Ufo, 562

Lámparas de pie

Floor lamps

Lampadaires



Absis, 26



Acapulco portátil, 63

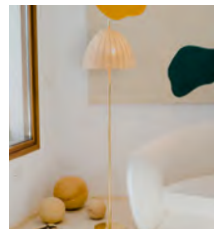

Ama, 74



Arco, 88



Atlanta, 100



Capuchina, 140



Indiana, 269



Jana, 280

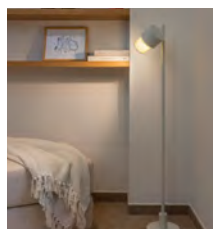

Kan, 308



Kea, 326

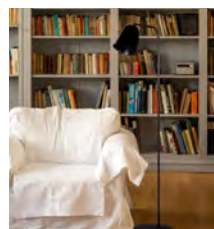

Lula, 347



Mad, 360

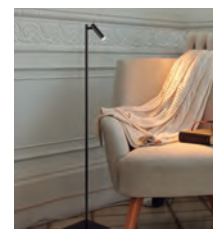

Manhattan, 374



Matrix, 382



Matrix led, 393

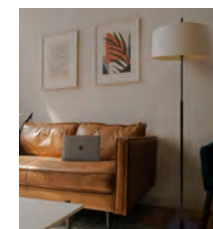

Nautic, 421

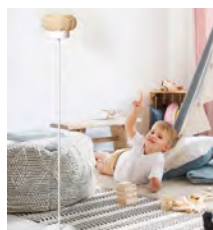

Niuet, 430

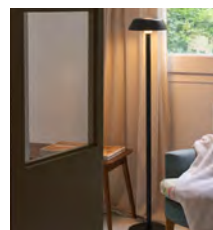

Sarria, 487



Sutton, 509



Thea, 536

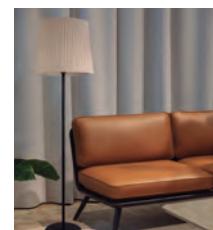

Toscana, 552

Lámparas de sobremesa

Table lamps

Lampes à poser

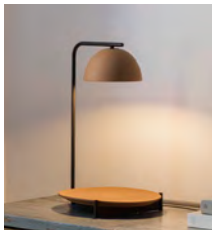

Absis, 28

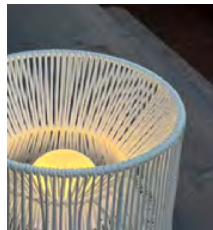

Acapulco portátil, 62



Ama, 70



Capuchina, 142



Cilindre, 158



Clipam, 180



Fanal, 228



H2, 257



Indiana, 271



Kan, 310

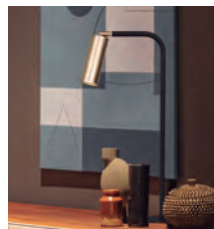

Kea, 327



Lula, 346

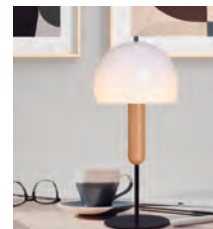

Mad, 361



Manhattan, 370



Matrix, 384



Matrix led, 394



Moon, 412



Nautic, 422



Niuet, 431



Oxygen, 451



Sarria, 484

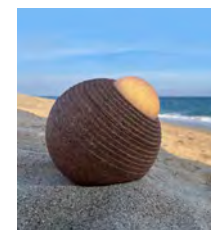

Terra, 518

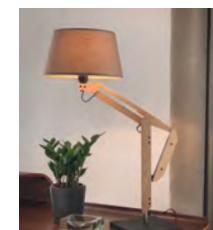

Thea, 538

Plafones
Ceiling lamps
Plafonniers



Absis, 30



Cim, 171



Cuadro, 203



Kea, 323



Moon, 413



Kan, 429



Rondo, 470



Rondo wood, 471

Lámparas portátiles
Portable lamps
Lampes portables

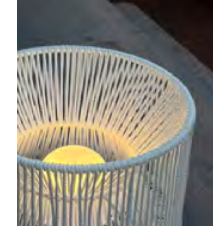

Acapulco s, 62



Acapulco p, 63



Fanal, 235



Niuet, 432



Terra, 518



Nuestra esencia

Luxcambra es una empresa familiar de Barcelona que desde 1966 trabaja con pasión para crear diseños y soluciones de iluminación con la voluntad de que contribuyan a mejorar los espacios que nos rodean y generar atmósferas con personalidad.

Nuestros diseños cuentan nuestra historia y es que nos importa mucho preservarla. Las lámparas de Luxcambra son capaces de emocionar por su existencia ya que detrás de cada una de ellas hay una historia que contar y el trabajo de muchas personas que con ilusión han aportado lo mejor de sí mismos.

Nuestro enfoque del diseño está basado en la funcionalidad, la búsqueda de la autenticidad en la simplicidad de formas y el trabajo con materiales naturales. Las luminarias de Luxcambra preservan la esencia del diseño racionalista, sin estridencias ni elementos superfluos, para ir a lo esencial, pero con una personalidad propia marcada por una fuerte influencia mediterránea.

Nuestro proceso de fabricación permite la adaptabilidad de nuestro catálogo y en nuestra

capacidad para ayudar a nuestros clientes a llevar a cabo sus ideas. Estamos orgullosos de poder ofrecer soluciones personalizadas que cumplan con los requisitos específicos de cada proyecto. A través de un cuidadoso trabajo de rediseño y adaptación, uno de nuestros objetivos principales es la personalización. Cada proyecto es único.

Nuestra responsabilidad corporativa consiste en promover prácticas productivas locales y justas, y nos esforzamos por mantener este compromiso. Nos gusta trabajar con materiales de nuestro territorio que contribuyan a mejorar la preservación del medio-ambiente; asimismo, nos preocupamos por el bienestar de las personas que trabajan con nosotros y colaboramos sólo con empresas de nuestro entorno.

Nuestro éxito y longevidad en el tiempo radica en la proximidad con nuestros colaboradores y clientes, en nuestra adaptabilidad y en la versatilidad de nuestro catálogo; en la implicación de nuestro equipo y en nuestra filosofía: escuchar y aprender cada día para poder mejorar.

Our essence

“Luxcambra is a family-owned business from Barcelona, which has been working passionately since 1966 to create lighting designs and solutions aiming at improving the spaces that surround us and create atmospheres with personality.

Our designs are not just products, but stories that we care about and strive to preserve. Luxcambra’s lamps are a testament to our passion for creating lighting solutions that leave an emotional mark on people for their existence, as every design is the result of the continuous efforts of our dedicated team, who has brought their best work.

At Luxcambra, our design philosophy is centred around functionality, authenticity, and the use of natural materials. Our luminaires are inspired by rationalist design principles, featuring clean and simple forms that prioritize essential elements over superfluous details. Yet, our designs are imbued with a strong Mediterranean influence, giving each luminaire a distinctive personality and character.

Our manufacturing process allows adaptability and customer-centricity. We take pride in our ability to offer customized solutions that cater

to the specific needs and requirements of each project. As one of our main goals is the focus on singularity, our team works diligently to ensure that every design is unique, achieved through meticulous redesign and adaptation processes which leverage our extensive catalogue and expertise.

Our corporate responsibility is to promote local and fair manufacturing practices, and we are eager to uphold this commitment. We prioritize working with materials that are sourced from our territory, with an emphasis on sustainability and environmental preservation. Additionally, we are deeply invested in the well-being of the people who work with us, and we exclusively collaborate with companies within our community to support and uplift the local region.

Our success and longevity over time lie in the closeness with our collaborators and clients, our adaptability and the versatility of our catalogue; the involvement of our team and our philosophy: listen and learn every day to improve.”

Notre essence

Luxcambra est une entreprise familiale à Barcelone qui depuis 1966, travaille avec passion pour créer des designs et des solutions d’illumination avec la volonté de contribuer à l’amélioration des espaces qui nous entourent et génèrent des atmosphères avec personnalité.

Nos créations racontent notre histoire et nous tenons beaucoup à la préserver. Les lampes de Luxcambra sont capables d’évoquer par leur existence, car derrière chacune d’entre elles il y a une histoire à raconter qui se transmet par le travail de nombreuses personnes qui ont apporté le meilleur d’eux-mêmes.

Notre approche de conception est basée sur la fonctionnalité, la recherche d’authenticité dans la simplicité des formes et le travail de matériaux naturels. Les luminaires de Luxcambra préservent l’essence du design rationaliste, sans excès ni éléments superflus pour aller à l’essentiel, mais pleine d’une personnalité marquée par une forte influence méditerranéenne.

Notre processus de fabrication permet l’adaptabilité de notre catalogue et sur notre capacité à accompagner nos clients dans la réalisation de leurs idées. Nous sommes fiers de pouvoir offrir des solutions sur mesure qui répondent aux exigences spécifiques de chaque projet. Grâce à un travail minutieux de reconception et d’adaptation, l’un de nos objectifs principaux est la singularité. Chaque projet est unique.

Notre responsabilité d’entreprise est de promouvoir des pratiques de fabrication locales et équitables, et nous nous efforçons de respecter cet engagement. Nous aimons travailler avec des matériaux de notre territoire qui contribuent à améliorer la préservation de l’environnement. De même, nous nous soucions du bien-être des personnes qui travaillent chez nous et nous collaborons uniquement avec des entreprises de notre région.

Notre succès et notre longévité dans le temps résident dans la proximité avec nos collaborateurs et clients, dans notre adaptabilité et dans la polyvalence de notre catalogue ainsi que dans l’implication de notre équipe et notre philosophie : écouter et apprendre chaque jour pour s’améliorer.

Valoramos la flexibilidad como una cualidad esencial

Los principales motivos que han hecho que nuestra empresa haya perdurado en el tiempo han sido su capacidad de adaptación al entorno constantemente cambiante y la flexibilidad a la hora de satisfacer las necesidades de nuestros clientes.

Desde un pequeño cambio de color o medida sobre una luminaria de nuestro catálogo a la realización de un proyecto integral de gran envergadura, en la medida de nuestras capacidades productivas siempre hacemos todo lo posible para satisfacer los requerimientos recibidos.

We value flexibility as an essential quality

The main reasons which made our company last over time have been our ability to adapt to the constantly changing environment and our flexibility in meeting the needs of our customers.

Whether from a small change of color or size on a lamp of our catalogue to the realization of an entire project of great importance, we always do everything possible to satisfy the requirements received within our productive capacities.

Nous valorisons la flexibilité comme une qualité essentielle

Les principales raisons qui ont fait perdurer notre entreprise dans le temps ont été notre capacité à s'adapter à un environnement en constante évolution et notre flexibilité à répondre aux besoins de nos clients.

D'un petit changement de couleur ou de mesures sur une lampe de notre catalogue à la réalisation d'un projet global de grande importance, nous mettons toujours tout en œuvre pour satisfaire les exigences reçues dans la mesure de nos capacités de production.



Adaptamos todo nuestro catálogo a las necesidades funcionales de cada cliente. Fotografía: Casa en el Eixample (Barcelona).

We adapt our entire catalogue to the functional needs of each client. Photography: House in the Eixample (Barcelona, Spain).

Nous adaptons l'ensemble de notre catalogue aux besoins fonctionnels de chaque client. Photographie : Maison dans l'Eixample (Barcelone).



Adaptamos todo nuestro catálogo al estilo propio de cada proyecto. Fotografía: SUBE Interiorismo. Biderbost Photo.

We adapt our entire catalogue to the particular style of each project. Photography: SUBE Interiorismo. Biderbost Photo.

Nous adaptons l'ensemble de notre catalogue au style propre à chaque projet. Photographie : SUBE Interiorismo. Biderbost Photo.



Adaptamos nuestras luminarias a los espacios de cada proyecto. Fotografía: Hotel Boutique Summum (Monells, Girona).

We adapt our lamps to the spaces of each project. Photography: Hotel Boutique Summum (Monells, Spain).

Nous adaptons nos luminaires aux espaces de chaque projet. Photographie: Hotel Boutique Summum (Monells, Gérone).

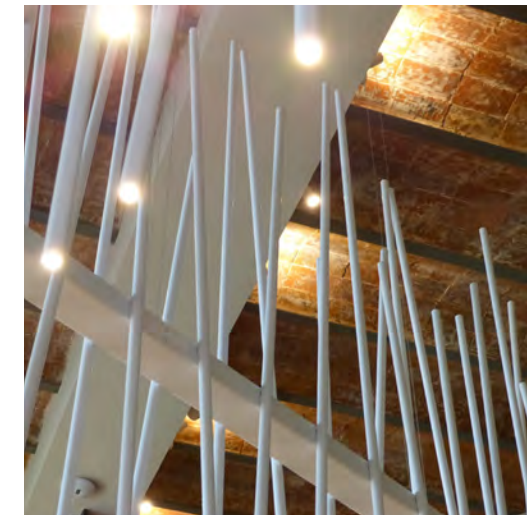

Ayudamos a nuestros clientes a llevar a cabo sus ideas. Trabajamos conjuntamente en el desarrollo del concepto y la producción para conseguir el mejor resultado. Fotografía: Restaurante El Posit del Serrallo (Tarragona).

We help our clients to carry out their ideas. We work together in the development of a concept and production to achieve the best result. Photography: El Posit del Serrallo Restaurant (Spain).

Nous aidons nos clients à concrétiser leurs idées. Nous travaillons ensemble dans le développement d'un concept et de la production pour obtenir le meilleur résultat. Photographie: Restaurant El Posit del Serrallo (Tarragone).



Conica. Joan Antoni Blanc. 1965
 Fanal. Jordi Vilanova. 1965
 Cilindre. Joan Antoni Blanc. 1966
 H2. Joan Cambra. 1986
 Parabolica. Joan Antoni Blanc. 1973



Reeditamos diseños icónicos para prolongar su existencia

En 2022 Luxcambra ha apostado por una selección de piezas históricas de autores consagrados como Jordi Vilanova, Joan Antoni Blanc o Joan Cambra, que se han reeditado con el mayor respeto posible, incluso con una intención de dar visibilidad y recuperar a creadores que también fueron pioneros del diseño contemporáneo y en el ámbito cultural con lámparas sencillas, bellas y útiles.

La reedición es una manera de prolongar la existencia de un diseño rindiendo homenaje a su creación sin alterar sus criterios sustanciales que agregan valor a la experiencia del usuario. Consideramos que la reedición de estos diseños icónicos enriquece el ciclo de vida de estas lámparas, porque las vinculamos a la modernidad actual que definimos por nuestro compromiso a una producción local con materiales naturales o reciclados.

Reeditar un diseño significa dar nueva vida a conceptos que han marcado nuestra historia y forman parte de quienes somos hoy por el aprendizaje recibido a lo largo del tiempo.

We reissue iconic designs to prolong their existence

In 2022, Luxcambra has betted on a selection of historical pieces by renowned authors such as Jordi Vilanova, Joan Antoni Blanc or Joan Cambra, which have been reissued with the greatest respect to the original, and with the intention of recovering and giving visibility to creators who were pioneers of contemporary design in the cultural field thanks to their simple, beautiful and functional lamps.

The reedition is a way to extend the existence of a design by paying homage to its creation without altering its substantial criteria which add value to the user's experience. We believe that the reedition of these iconic designs enriches the life cycle of these lamps, because we link them to our modernity that we define by our commitment to local production with natural or recycled materials.

Redesigning means giving new life to concepts that have marked our history and are part of who we are today thanks to the learning endured over time.

Nous rééditons des designs iconiques pour prolonger leur existence

En 2022, Luxcambra a misé sur une sélection de pièces historiques d'auteurs confirmés tels que Jordi Vilanova, Joan Antoni Blanc ou Joan Cambra, qui ont été préservées avec le plus grand respect possible et dont l'intention est de récupérer et donner de la visibilité aux créateurs qui étaient pionniers du design contemporain dans le domaine culturel par leurs lampes simples, belles et utiles.

La réédition est un moyen de prolonger l'existence d'un design en rendant hommage à sa création sans altérer ses critères substantiels, qui ajoutent de la valeur à l'expérience de son utilisateur. Nous pensons que la réédition de ces designs iconiques enrichit le cycle de vie de ces lampes, car nous les rattachons à la modernité actuelle que nous définissons par notre engagement pour une production locale avec des matériaux naturels ou recyclés.

Rééditer un design, c'est donner une nouvelle vie à des concepts qui ont marqué notre histoire et font partie de ce que nous sommes aujourd'hui grâce à l'apprentissage reçu au fil du temps.



Exploramos la comunión entre artesanía y diseño

La artesanía es un camino hacia la autenticidad porque se acerca a la propia creación según lo que uno siente y percibe. El saber hacer se consolida por la experiencia táctil y sensorial con materiales naturales de proximidad, que nos permite reconectar con nuestras habilidades humanas para explorar la riqueza de los recursos orgánicos que nos rodean.

El valor de la artesanía se ancla en la libertad de crear piezas memorables por la emoción que conllevan. Esta forma de trabajo desarrolla el sentido de creatividad para dar vida a diseños que cumplen con las necesidades de cada proyecto. La artesanía escribe una historia, propia a cada producto, y que se enriquece por su calidad natural y los recuerdos que se adquieran a lo largo del tiempo. Explorar la artesanía responde a esta búsqueda de sentido que nos une a lo que somos y lo que esperamos para el futuro.

We explore the union between craftwork and design

Craftwork is a path to authenticity because it relies on the core of creation defined by what a person feels and perceives. The know-how is consolidated by the tactile sensory experience with local natural materials, which allows us to reconnect with our human abilities to explore the richness of the organic resources surrounding us.

The value of craftwork is anchored in the freedom to create memorable pieces carrying an emotional experience. This manner of working develops a sense of creativity to give life to designs that meet the needs of each project. Craftwork writes a story specific to each product enriched by its natural quality and the memories cherished over time. Exploring craftwork answers this search for meaning that unites us with who we are and what we hope for the future.

Nous explorons la communion entre l'artisanat et le design

L'artisanat est un chemin vers l'authenticité car il aborde le cœur même de la création en fonction de ce que tout un chacun ressent et perçoit. Le savoir-faire est consolidé par l'expérience tactile et sensorielle des matériaux naturels locaux, ce qui nous permet de renouer avec nos capacités humaines pour explorer la richesse des ressources organiques qui nous entourent.

La valeur de l'artisanat est ancrée dans la liberté de créer des pièces mémorables par l'émotion qu'elles véhiculent. Cette façon de travailler développe le sens de la créativité pour donner vie à des conceptions qui répondent aux besoins de chaque projet. L'artisanat écrit une histoire, propre à chaque produit qui s'enrichit par sa qualité naturelle et les souvenirs acquis au fil du temps. Explorer l'artisanat répond à cette recherche de sens qui nous unit à qui nous sommes et à ce que nous espérons pour l'avenir.

Absis

Jordi Llopis

La colección Absis quiere rendir homenaje a la tradicional bóveda catalana y a uno de los materiales utilizados para su construcción: la arcilla de la zona de Vacamorta en la comarca del Empordà en Girona.

Piezas hechas a mano donde cada una de ellas tiene identidad propia. La terracota de la pantalla combinada con las estructuras simples de hierro aporta a la colección una calidez especial ideal para espacios muy diversos.

Ya sea con la lámpara apagada o encendida la singularidad del material, sus acabados y sus formas hacen que la colección se acerque al usuario y se ponga de relieve el gusto por el tacto y su calidad natural.

The Absis collection pays tribute to the traditional Catalan vault and to one of the materials used for its construction: the clay from the Vacamorta area in the Empordà region of Girona (Spain).

For these handmade pieces, each one of them has its own identity. The terracotta of the lampshade combined with the iron structures gives to the collection a natural warmth, ideal for different types of spaces.

Whether switched on or off, the uniqueness of the material, its finishes and its shapes urge the user to touch the lamp and explore its natural quality.

La collection Absis veut rendre hommage à la voûte traditionnelle catalane et à l'un des matériaux utilisés pour sa construction: l'argile de la région de Vacamorta dans le canton de l'Empordà à Gérone (Espagne).

Ces pièces sont faites à la main et chacune d'elles a sa propre identité. La terre cuite de l'abat-jour combinée aux structures en fer confère à la collection une chaleur naturelle idéale pour différents types d'espaces.

Que ce soit avec la lampe éteinte ou allumée, la particularité du matériau, ses finitions et ses formes incitent son utilisateur au toucher et à l'exploration de cette qualité naturelle.

Familia / Family / Famille

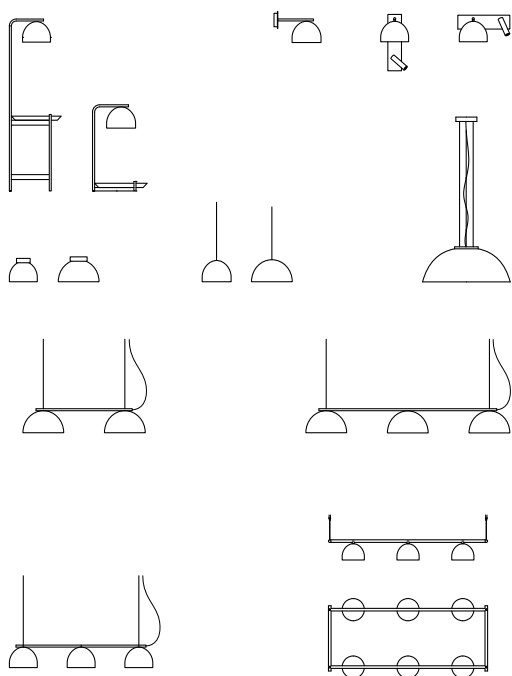



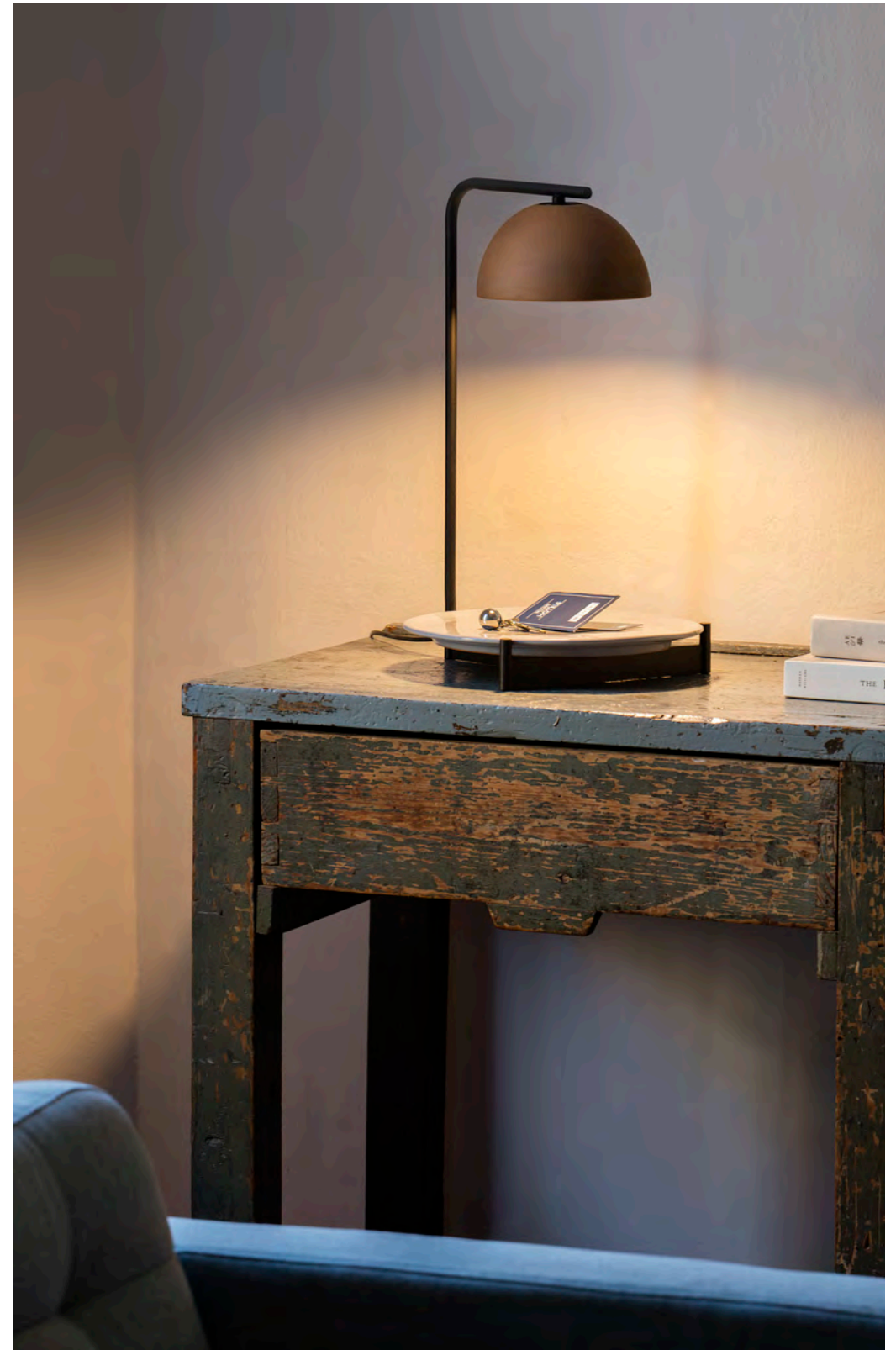





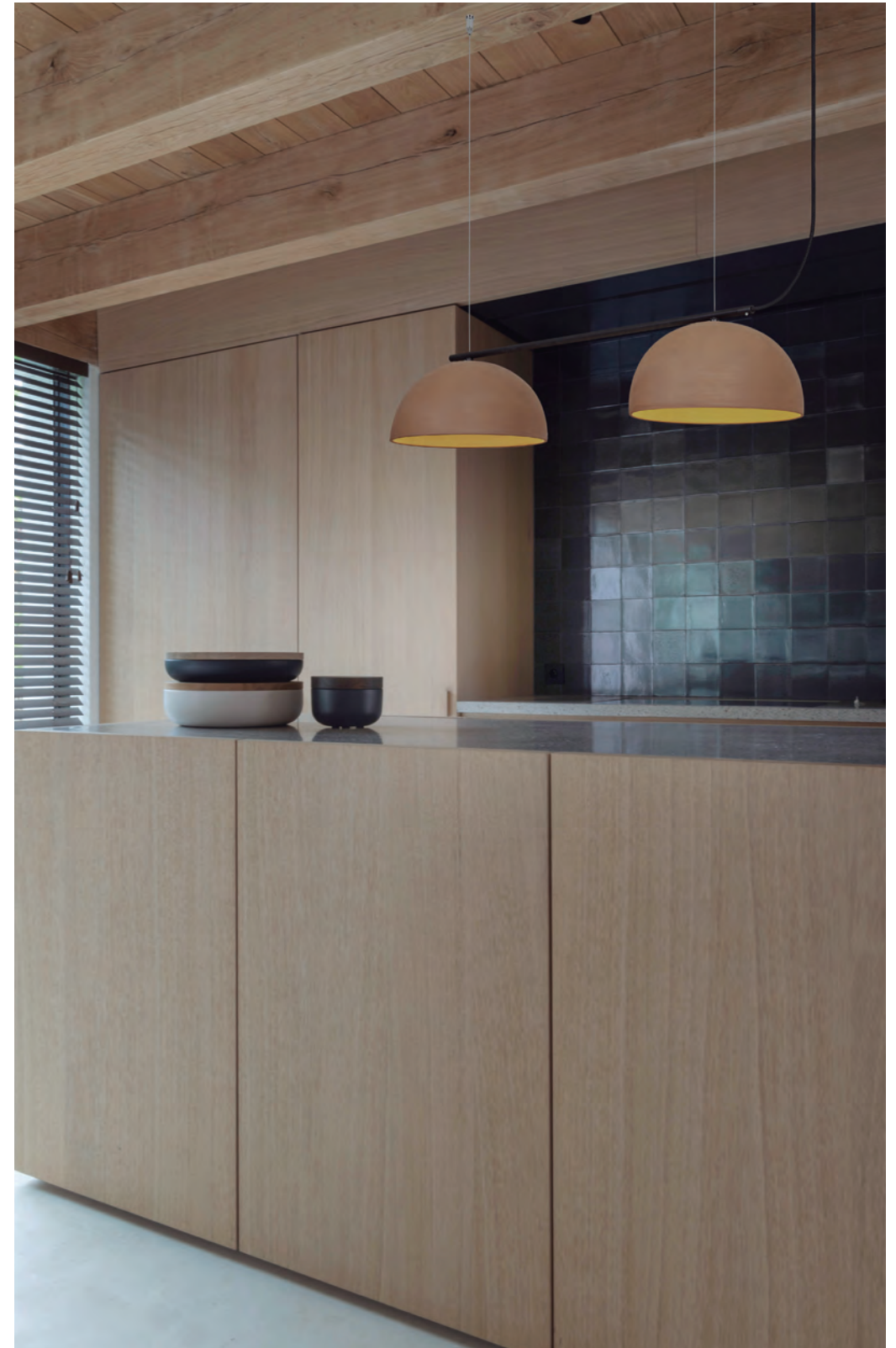





Estas nuevas versiones de grandes dimensiones, en series lineales o rectangulares, permiten llenar grandes espacios y crear ambientes lumínicos especiales que se adaptan a cualquier necesidad.

This new large pendant versions, either in linear or rectangular series, allows to fill in large spaces and create special lighting environments adapted to the special needs of any projects.

Ces nouvelles grandes versions, que ce soit en séries linéaires ou rectangulaires, permettent de remplir de grands espaces et de créer des environnements éclairés sur mesure qui s'adaptent à tous les besoins.





Las pantallas de cerámica en terracota natural son piezas hechas a mano donde cada una de ellas tiene identidad propia. Ya sea con la lámpara apagada o encendida, la singularidad del material da personalidad al espacio y esta nueva versión de colgante pone de relieve la calidad natural de la fabricación artesanal.

These ceramic shades in natural terracotta are handmade pieces and each one of them has its own identity. Whether switched on or off, the uniqueness of the material, gives more personality to the environment. This new larger hanging lamp highlights the authentic quality of craftsmanship.

Les abat-jour en céramique de terre cuite naturelle sont des pièces faites à la main où chacun d'eux a sa propre identité. Que ce soit avec la lampe éteinte ou allumée, l'authenticité du matériau donne de la personnalité à l'espace et cette nouvelle version de suspension met en valeur la qualité naturelle de l'artisanat.





Esta nueva versión de aplique, en vertical o horizontal con lector, se adapta perfectamente como lámpara de cabecera creando un ambiente relajado. La pantalla de cerámica hecha a mano, da un toque natural de calidez al entorno.

This new wall-mounted version Absis, whether oriented vertically and horizontally with led reader is perfectly suitable as a bedside lamp and will create a cozy atmosphere. The hand-made ceramic shade adds a touch of natural quality to the environment.

Cette nouvelle version d'applique ABSIS, en position verticale ou horizontale avec lecteur, convient parfaitement comme lampe de chevet créant une ambiance relaxante. L'abat-jour en céramique fait à la main donne une touche naturelle de qualité à l'espace environnant.







Absis p / Absis s

Estructura metálica de hierro y pantalla y mesa de cerámica artesanal*. Cable eléctrico negro.

Iron metallic structure and handmade ceramic* lampshade and table support. Black electric cable.

Structure métallique en fer et abat-jour et support de table en céramique faits à la main*. Câble électrique noir.



PCB LED 3,5W
420 lm / 2.700 K



BIM/3D files: luxcambra.com/3D (3ds, dwg, 3dm, skp, rfa)

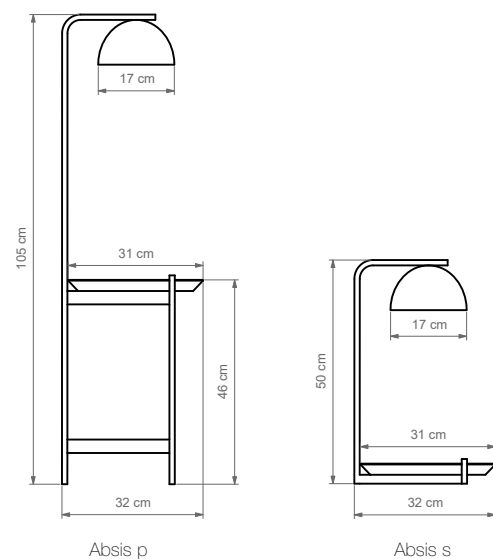
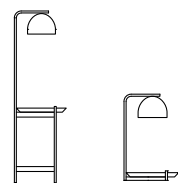

Absis p

Absis s

ESTRUCTURA
STRUCTURE
STRUCTURE

PANTALLA Y MESA
LAMP SHADE & TABLE
ABAT-JOUR ET TABLE

4248	3219	● Blanco roto texturado RAL 9002 Textured off-white RAL 9002 <i>Blanc cassé texturé RAL 9002</i>	● Cerámica en terracota natural Natural ceramic terracotta <i>Céramique naturelle terre cuite</i>
4249	3220	● Blanco roto texturado RAL 9002 Textured off-white RAL 9002 <i>Blanc cassé texturé RAL 9002</i>	● Blanco roto barnizado Off-white varnished ceramic <i>Céramique vernie blanc cassé</i>
4250	3221	● Negro texturado RAL 9005 Textured black RAL 9005 <i>Noir texturé RAL 9005</i>	● Cerámica en terracota natural Natural ceramic terracotta <i>Céramique naturelle terre cuite</i>
4251	3222	● Negro texturado RAL 9005 Textured black RAL 9005 <i>Noir texturé RAL 9005</i>	● Blanco roto barnizado Off-white varnished ceramic <i>Céramique vernie blanc cassé</i>
PLATO DE CERÁMICA OPCIONAL OPTIONAL CERAMIC PLATE PLATEAU CÉRAMIQUE OPTIONNEL			
4252		● Cerámica en terracota natural Natural ceramic terracotta <i>Céramique naturelle terre cuite</i>	
4253		● Blanco roto barnizado Off-white varnished ceramic <i>Céramique vernie blanc cassé</i>	

Cada pieza de cerámica es única y tiene las imperfecciones derivadas de su fabricación artesanal.

Each piece of ceramic is unique and has the imperfections derived from its artisanal manufacturing.

Chaque pièce de céramique est unique et présente les imperfections issues de sa fabrication artisanale.

Absis pl

Soporte al techo de hierro y pantalla de cerámica artesanal*.

Iron ceiling support and handmade ceramic lampshade*.

Support de plafond en fer et abat-jour en céramique faite à la main*.



PCB LED 3,5W
420 lm / 2.700 K



BIM/3D files: luxcambra.com/3D (3ds, dwg, 3dm, skp, rfa)

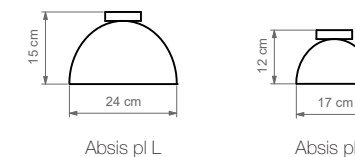

Absis pl L

Absis pl S

ESTRUCTURA
STRUCTURE
STRUCTURE

PANTALLA
LAMP SHADE
ABAT-JOUR

1587	1591	● Blanco roto texturado RAL 9002 Textured off-white RAL 9002 <i>Blanc texturé RAL 9002</i>	● Cerámica en terracota natural Natural ceramic terracotta <i>Céramique naturelle terre cuite</i>
1588	1592	● Blanco roto texturado Textured off-white RAL 9002 <i>Blanc texturé RAL 9002</i>	● Blanco roto barnizado Off-white varnished ceramic <i>Céramique vernie blanc cassé</i>
1589	1593	● Negro texturado RAL 9005 Textured black RAL 9005 <i>Noir texturé RAL 9005</i>	● Cerámica en terracota natural Natural ceramic terracotta <i>Céramique naturelle terre cuite</i>
1590	1594	● Negro texturado RAL 9005 Textured black RAL 9005 <i>Noir texturé RAL 9005</i>	● Blanco roto barnizado Off-white varnished ceramic <i>Céramique vernie blanc cassé</i>

Absis c

Estructura metálica de hierro y pantallas de cerámica artesanal*. Cable eléctrico negro.

Iron metallic structure and handmade ceramic lampshades*. Black electric cable.

Structure métallique en fer et abat-jours en céramique faits à la main*. Câble électrique noir.



PCB LED 3,5W
420 lm / 2.700 K



E-27 LED 12W
(Absis c XL)



BIM/3D files: luxcambra.com/3D (3ds, dwg, 3dm, skp, rfa)

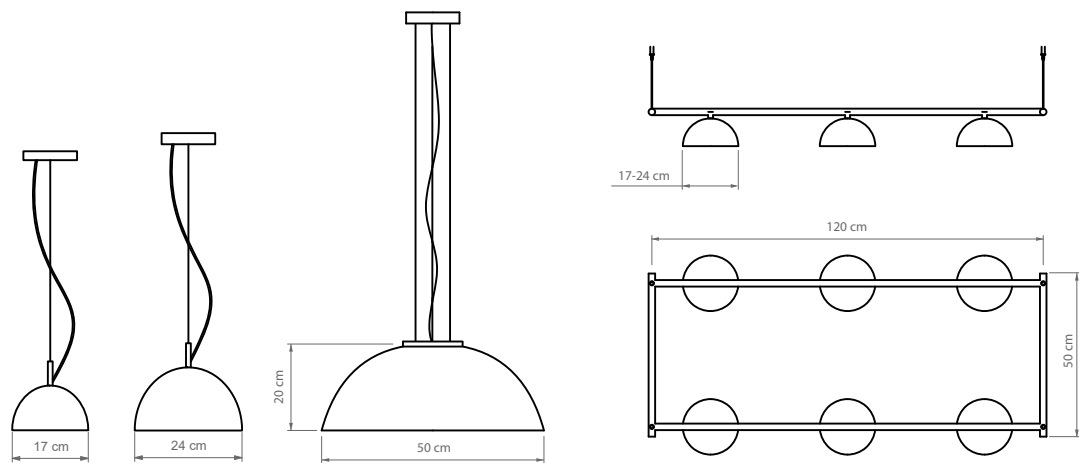

Absis c 1 S

Absis c 1 L

Absis c XL

Absis c lineal 6

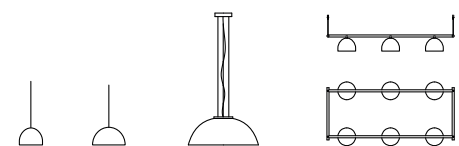

1567

1571

1618

1614

ESTRUCTURA
STRUCTURE
STRUCTURE

● Blanco roto texturado
Textured off-white
Blanc cassé texturé

PANTALLA
LAMP SHADE
ABAT-JOUR

● Cerámica en terracota natural
Natural ceramic terracotta
Céramique naturelle terre cuite

1568

1572

1615

● Blanco roto texturado
Textured off-white
Blanc cassé texturé

● Blanco roto barnizado
Off-white varnished ceramic
Céramique vernie blanc cassé

1569

1573

1620

1616

● Negro texturado
Textured black
Noir texturé

● Cerámica en terracota natural
Natural ceramic terracotta
Céramique naturelle terre cuite

1570

1574

1617

● Negro texturado
Textured black
Noir texturé

● Blanco roto barnizado
Off-white varnished ceramic
Céramique vernie blanc cassé

Cada pieza de cerámica es única y tiene las imperfecciones derivadas de su fabricación artesanal.

Each piece of ceramic is unique and has the imperfections derived from its artisanal manufacturing.

Chaque pièce de céramique est unique et présente les imperfections issues de sa fabrication artisanale.

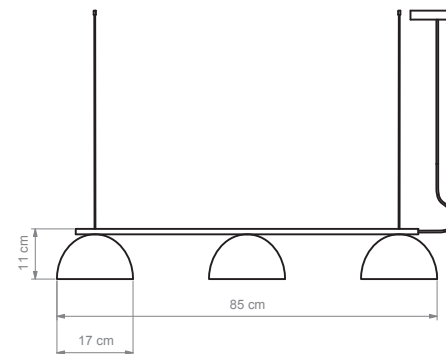

Absis c lineal 3 S

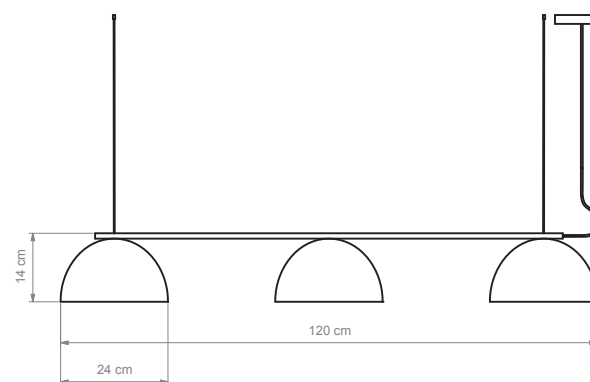

Absis c lineal 3 L

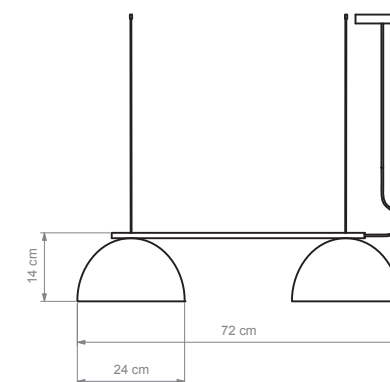

Absis c lineal 2



1579

1575

1583

ESTRUCTURA
STRUCTURE
STRUCTURE

● Blanco roto texturado
Textured off-white
Blanc cassé texturé

PANTALLA
LAMP SHADE
ABAT-JOUR

● Cerámica en terracota natural
Natural ceramic terracotta
Céramique naturelle terre cuite

1580

1576

1584

● Blanco roto texturado
Textured off-white
Blanc cassé texturé

● Blanco roto barnizado
Off-white varnished ceramic
Céramique vernie blanc cassé

1581

1577

1585

● Negro texturado
Textured black
Blanc cassé texturé

● Cerámica en terracota natural
Natural ceramic terracotta
Céramique naturelle terre cuite

1582

1578

1586

● Negro texturado
Textured black
Blanc cassé texturé

● Blanco roto barnizado
Off-white varnished ceramic
Céramique vernie blanc cassé

Cada pieza de cerámica es única y tiene las imperfecciones derivadas de su fabricación artesanal.

Each piece of ceramic is unique and has the imperfections derived from its artisanal manufacturing.

Chaque pièce de céramique est unique et présente les imperfections issues de sa fabrication artisanale.

Absis a

Estructura metálica de hierro y pantallas de cerámica artesanal*.

Iron metallic structure and handmade ceramic lampshades*.

Structure métallique en fer et abat-jours en céramique faits à la main.*



PCB LED 3,5W
420 lm / 2.700 K



BIM/3D files: luxcambra.com/3D (3ds, dwg, 3dm, skp, rfa)

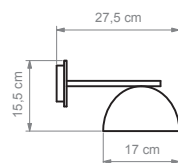

Absis a



ESTRUCTURA
STRUCTURE
STRUCTURE

PANTALLA
LAMP SHADE
ABAT-JOUR

2618	● Blanco roto texturado RAL 9002 Textured off-white RAL 9002 <i>Blanc cassé texturé RAL 9002</i>	● Cerámica en terracota natural Natural ceramic terracotta <i>Céramique naturelle terre cuite</i>
2619	● Blanco roto texturado RAL 9002 Textured off-white RAL 9002 <i>Blanc cassé texturé RAL 9002</i>	● Blanco roto barnizado Off-white varnished ceramic <i>Céramique vernie blanc cassé</i>
2620	● Negro texturado RAL 9005 Textured black RAL 9005 <i>Noir texturé RAL 9005</i>	● Cerámica en terracota natural Natural ceramic terracotta <i>Céramique naturelle terre cuite</i>
2621	● Negro texturado RAL 9005 Textured black RAL 9005 <i>Noir texturé RAL 9005</i>	● Blanco roto barnizado Off-white varnished ceramic <i>Céramique vernie blanc cassé</i>

Cada pieza de cerámica es única y tiene las imperfecciones derivadas de su fabricación artesanal.

Each piece of ceramic is unique and has the imperfections derived from its artisanal manufacturing.

Chaque pièce de céramique est unique et présente les imperfections issues de sa fabrication artisanale.

Absis a lector

Estructura metálica de hierro y pantallas de cerámica artesanal*.

Iron metallic structure and handmade ceramic lampshades*.

Structure métallique en fer et abat-jours en céramique faits à la main.*



PCB LED 3,5W
420 lm / 2.700 K



LED 3 W
150 lm / 2.700 K



BIM/3D files: luxcambra.com/3D (3ds, dwg, 3dm, skp, rfa)

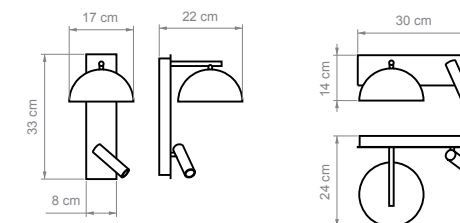

Absis a lector vertical

Absis a lector horizontal



ESTRUCTURA
STRUCTURE
STRUCTURE

PANTALLA
LAMP SHADE
ABAT-JOUR

2729	2660	● Blanco roto texturado RAL 9002 Textured off-white RAL 9002 <i>Blanc cassé texturé RAL 9002</i>	● Cerámica en terracota natural Natural ceramic terracotta <i>Céramique naturelle terre cuite</i>
2730	2661	● Blanco roto texturado RAL 9002 Textured off-white RAL 9002 <i>Blanc cassé texturé RAL 9002</i>	● Blanco roto barnizado Off-white varnished ceramic <i>Céramique vernie blanc cassé</i>
2731	2662	● Negro texturado RAL 9005 Textured black RAL 9005 <i>Noir texturé RAL 9005</i>	● Cerámica en terracota natural Natural ceramic terracotta <i>Céramique naturelle terre cuite</i>
2732	2663	● Negro texturado RAL 9005 Textured black RAL 9005 <i>Noir texturé RAL 9005</i>	● Blanco roto barnizado Off-white varnished ceramic <i>Céramique vernie blanc cassé</i>

Cada pieza de cerámica es única y tiene las imperfecciones derivadas de su fabricación artesanal.

Each piece of ceramic is unique and has the imperfections derived from its artisanal manufacturing.

Chaque pièce de céramique est unique et présente les imperfections issues de sa fabrication artisanale.

Acapulco

Javier Martínez

La colección Acapulco es ideal para generar un ambiente acogedor y confortable. Sus pantallas están confeccionadas artesanalmente con cuerda de algodón, yute o poliamida y están disponibles en presentaciones y medidas diferentes.

La versión outdoor es ideal para terrazas y porches que necesiten luz cálida para generar un ambiente acogedor y confortable.

The Acapulco collection is ideal for creating a welcoming and cosy environment. Its lampshades are handmade with cotton, jute or polyamide cord and are available in different forms and sizes.

The outdoor version is ideal for terraces and porches that need warm light to create a welcoming and cosy atmosphere.

La collection Acapulco est idéale pour créer un environnement accueillant et cosy. Ses abat-jours sont fabriqués à la main avec de la corde en coton, en jute ou en polyamide et sont disponibles en formes et tailles différentes.

La version outdoor est idéale pour les terrasses et les porches qui ont besoin d'une lumière chaude pour créer une atmosphère accueillante et cosy.

Familia / Family / Famille

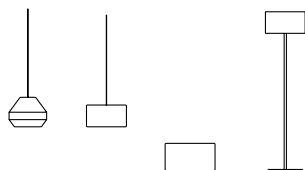







La versión portátil es ideal para terrazas y porches que necesiten luz cálida para generar un ambiente acogedor y confortable. Sus pantallas confeccionadas con cuerda de poliamida son aptas para uso exterior. Su fuente de luz LED sin conexión a red se sujeta a la pantalla a través de un sistema de sujeción magnético y la batería puede recargarse por un sistema de inducción. Tiene una autonomía de 6 h de duración a máxima potencia.

The portable version is ideal for terraces and porches that need warm light to create a welcoming and cosy atmosphere.

Their lampshades made from polyamide cord are suitable for outdoor use. Its off-grid LED light source is attached to the lampshade by a magnetic clamping system and the battery is rechargeable by induction system. It has an autonomy of 6 hours at maximum power use.

La version portable est idéale pour les terrasses et les porches qui ont besoin d'une lumière chaude pour créer une atmosphère accueillante et cosy. Ses abat-jours fabriqués avec de la corde en polyamide sont adaptés pour un usage extérieur. Sa source de lumière LED sans fil est un module fixé à l'abat-jour par magnétisme et la batterie est rechargeable par un système d'induction. Elle a une autonomie de 6 heures à puissance maximale.





Acapulco c

Florón en negro y pantallas de cuerda de poliamida o algodón. Cable de algodón negro.

Black ceiling rose and string lampshades made of polyamide or cotton. Black cotton cable.

Support en noir et abat-jours en corde de polyamide ou coton. Câble en coton noir.



E-27 LED 12W



BIM/3D files: luxcambra.com/3D (3ds, dwg, 3dm, skp, rfa)

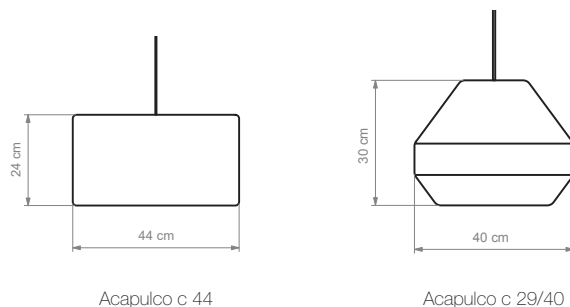

Acapulco c 44

Acapulco c 29/40



	FLORÓN CEILING ROSE PAVILLON	PANTALLA LAMP SHADE ABAT-JOUR	CABLE CABLE CÂBLE
1017	● Negro Black Noir	▨ Cuerda poliamida blanco roto Off-white polyamide string Corde en polyamide blanc cassé	● Algodón negro Black cotton Coton noir
1018	● Negro Black Noir	■ Cuerda poliamida negra Black polyamide string Corde en polyamide noir	● Algodón negro Black cotton Coton noir
1354	● Negro Black Noir	▨* Cuerda algodón verde* Green cotton string Corde en coton vert	● Algodón negro Black cotton Coton noir
1355	● Negro Black Noir	▨* Cuerda algodón beige* Beige cotton string Corde en coton beige	● Algodón negro Black cotton Coton noir
1019	● Negro Black Noir	▨* Cuerda algodón verde* Green cotton string Corde en coton vert	● Algodón negro Black cotton Coton noir
1020	● Negro Black Noir	▨* Cuerda algodón beige* Beige cotton string Corde en coton beige	● Algodón negro Black cotton Coton noir

* 80% algodón reciclado y 20% otras fibras | 80% recycled cotton and 20% other fibers | 80% coton recyclé et 20% autres fibres

Acapulco portátil s / Acapulco portátil p

Estructura blanco o negro y pantallas de cuerda de poliamida. Sin conexión a red. Alimentación con fuente de luz led con batería recargable. 6h duración máxima potencia. Sujeción magnética a la pantalla.

Black or white structure, string lampshades made of polyamide. No connection to the network. Led light source power supply with rechargeable battery. 6h of battery life. Magnetic grip to the lampshade.

Structure en noir ou blanc et abat-jours en corde de polyamide. Sans connexion au réseau. Source d'alimentation LED avec batterie rechargeable. 6h d'autonomie de batterie. Fixation magnétique à l'abat-jour.



290 lm / 3.000K



BIM/3D files: luxcambra.com/3D (3ds, dwg, 3dm, skp, rfa)

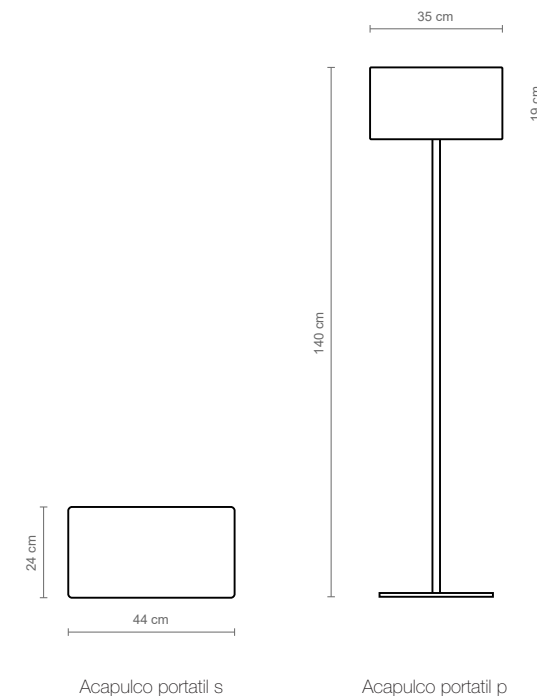

Acapulco portátil s

Acapulco portátil p

	ESTRUCTURA STRUCTURE STRUCTURE	PANTALLA LAMP SHADE ABAT-JOUR
3000	● Blanco mate texturado RAL 9016 Textured matt white RAL 9016 Blanc mat texturé RAL 9016	▨ Cuerda poliamida blanco roto Off-white polyamide string Corde en polyamide blanc cassé
3001	● Negro texturado RAL 9005 Textured black RAL 9005 Noir texturé RAL 9005	■ Cuerda poliamida negra Black polyamide string Corde en polyamide noir

Ama

Luxcambra & Mariano Chitarrini

Ama, viene del catalán “a mà”, que significa “hecha a mano”, y es como está fabricada esta lámpara. Con madera de haya torneada a mano, detalles en latón macizo, y pantalla tejida a mano en mimbre*, “vimet” en catalán.

La colección Ama es 100% de producción local, mediterránea, simple y elegante.

Diseñada por Chitarrini Studio en Barcelona, e inspirada en las atmósferas de las casas mediterráneas de los grandes arquitectos del siglo XX, es un elogio a la artesanía local.

Amà, comes from the Catalan “a mà”, which means “handmade”, and it is how this collection is produced. With hand-turned beech wood, solid brass details, and hand-woven natural wicker lampshade and from “vimet” in Catalan.

The collection is 100% from local production, Mediterranean, simple and elegant.

Designed by Chitarrini Studio in Barcelona, and inspired by the atmospheres of Mediterranean houses of the great architects of the 20th century, it is a compliment to the local crafts.

Amà, vient du catalan «a mà», qui signifie «fait à la main», et c'est ainsi que cette collection est fabriquée. Avec du bois de hêtre tourné à la main, des détails en laiton massif et un abat-jour en osier naturel tissé à la main, du “vimet” en catalan.

La collection est 100% de production locale, méditerranéenne, simple et élégante.

Conçue par Chitarrini Studio à Barcelone, et inspirée par les atmosphères des maisons méditerranéennes des grands architectes du 20ème siècle, c'est un compliment à l'artisanat local.

Família / Family / Famille

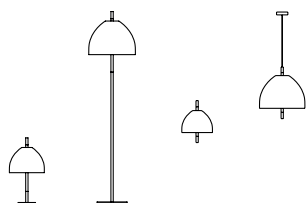

* La palabra mimbre sufrió una asimilación sobre su forma más antigua “vimbre” y viene del latín “vimen”, “viminis”.















La pantalla está tejida a mano con mimbre natural. Sus ramas son delgadas, largas y flexibles y permiten darle la forma deseada.

The lampshade is handwoven with natural wicker. Its branches are thin, long and flexible which allows to give it the desired shape.

L'abat-jour est tissé à la main avec de l'osier naturel. Ses branches sont fines, longues et souples ce qui permet de lui donner la forme souhaitée.



Ama s / Ama p

Estructura en madera de haya y latón pulido o lacado en blanco y pantalla de mimbre natural trenzado a mano. Cable eléctrico de PVC blanco.

Structure in beech wood and polished or white lacquered and handmade shade of natural wicker. White PVC electrical cable.

Structure en bois de hêtre et laiton poli ou laqué blanc et bat-jour tressé à la main en osier naturel. Câble électrique en PVC blanc.



2 x E-27 LED 12W



BIM/3D files: luxcambra.com/3D (3ds, dwg, 3dm, skp, rfa)

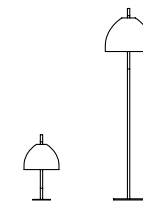
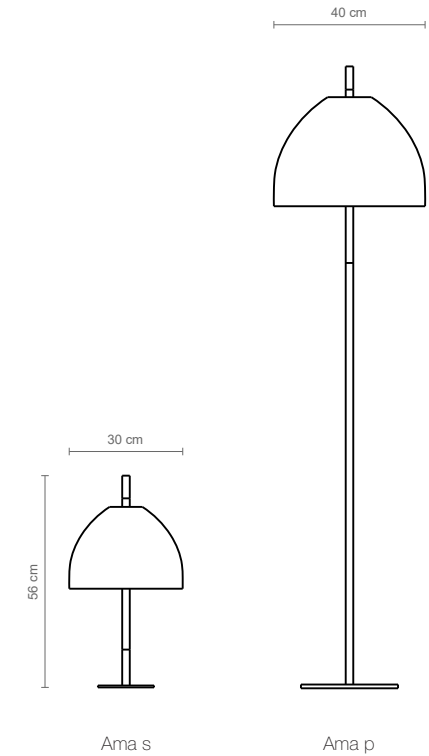

3228

4268

● Blanco mate texturado RAL 9016
Textured mat white RAL 9016
Blanc texturé mat RAL 9016

■ Mimbre natural
Natural wicker
Osier naturel

■ PVC blanco
White PVC
PVC blanc

3229

4269

● Latón pulido
Polished brass
Laiton poli

■ Mimbre natural
Natural wicker
Osier naturel

■ PVC blanc
White PVC
PVC blanc

Ama c

Estructura en madera de haya y latón pulido o lacado en blanco y pantalla de mimbre natural trenzado a mano. Cable eléctrico de algodón blanco.

Structure in beech wood and polished or white lacquered and handmade shade of natural wicker. White cotton electrical cable.

Structure en bois de hêtre et laiton poli ou laqué blanc et bat-jour tressé à la main en osier naturel. Câble électrique en coton blanc.



2 x E-27 LED 12W



BIM/3D files: luxcambra.com/3D (3ds, dwg, 3dm, skp, rfa)

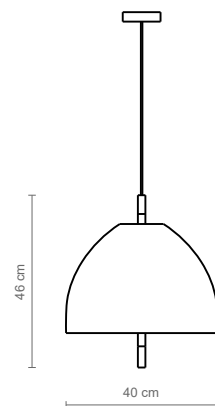

	ESTRUCTURA STRUCTURE STRUCTURE	PANTALLA LAMP SHADE ABAT-JOUR	CABLE CABLE CÂBLE
1605	Blanco mate texturado RAL 9016 Textured mat white RAL 9016 <i>Blanc texturé mat RAL 9016</i>	Mimbre natural Natural wicker <i>Osier naturel</i>	Algodón blanco White cotton <i>Coton blanc</i>
1606	Latón pulido Polished brass <i>Laiton poli</i>	Mimbre natural Natural wicker <i>Osier naturel</i>	Algodón blanco White cotton <i>Coton blanc</i>

Ama a

Estructura en madera de haya y latón pulido o lacado en blanco y pantalla de mimbre natural trenzado a mano.

Structure in beech wood and polished or white lacquered and handmade shade of natural wicker.

Structure en bois de hêtre et laiton poli ou laqué blanc et bat-jour tressé à la main en osier naturel.



E-27 LED 12W



BIM/3D files: luxcambra.com/3D (3ds, dwg, 3dm, skp, rfa)

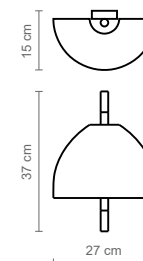

	ESTRUCTURA STRUCTURE STRUCTURE	PANTALLA LAMP SHADE ABAT-JOUR
2642	Blanco mate texturado RAL 9016 Textured mat white RAL 9016 <i>Blanc texturé mat RAL 9016</i>	Mimbre natural Natural wicker <i>Osier naturel</i>
2643	Latón pulido Polished brass <i>Laiton poli</i>	Mimbre natural Natural wicker <i>Osier naturel</i>

Arco

Luxcambra team

Las lámparas Arco, con sus brazos articulados que se extienden desplazando los puntos de luz, se adaptan muy bien a cualquier espacio. Su diseño es apropiado tanto para uso doméstico como para proyectos de restauración.

Sus rótulas permiten el giro horizontal de 180 grados de la pantalla y en el caso del pie Arco, una pieza deslizante permite además acercar o alejar la pantalla a voluntad.

The Arco lamps, with their articulated and extendable arms, allow you to move the points of light and adapt them to any type of space. Its design is ideal for both domestic use and restoration projects.

Its joints allow a 180 degree horizontal rotation of the lampshade, as for the floor lamp Arco, a sliding piece also allows you to move closer or further away the shade as you need.

Les lampes Arco, avec leurs bras articulés extensibles permettant de déplacer les points de lumière, s'adaptent parfaitement à tout type d'espace. Leur design est idéal aussi bien pour l'usage domestique que pour les projets de restauration.

Ses rotules permettent un pivotement horizontal à 180 degrés de l'abat-jour, et pour le modèle de pied Arco, une pièce coulissante permet également de rapprocher ou éloigner l'abat-jour selon vos besoins.

Familia / Family / Famille

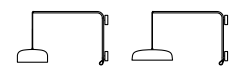
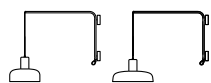
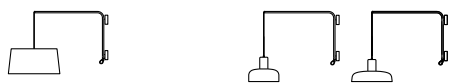
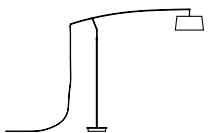









Arco p

Estructura en negro. Pantalla de loneta, arpillera, osaka o cotonet. Cable eléctrico de PVC negro.

Black structure. Cotton, sacking, osaka or cotonet lampshade. Black electrical PVC cable.

Structure en noir. Abat-jour en coton, en toile, en osaka ou en cotonet. Câble électrique en PVC noir.



E-27 LED 12W



BIM/3D files: luxcambra.com/3D (3ds, dwg, 3dm, skp, rfa)

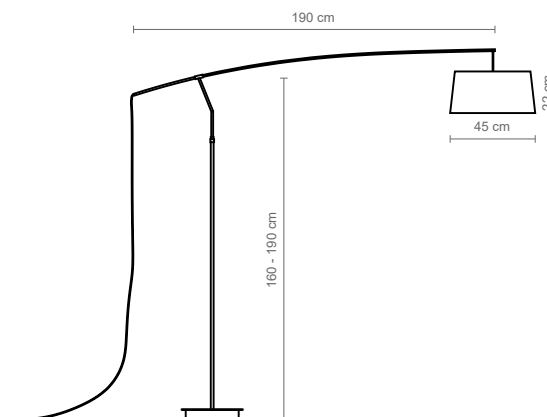

	ESTRUCTURA STRUCTURE STRUCTURE	PANTALLA LAMP SHADE ABAT-JOUR	CABLE CABLE CÂBLE
4061	● Negro texturado RAL 9005 Textured black RAL 9005 <i>Noir texturé RAL 9005</i>	■ Cotonet negro Black cotonet <i>Cotonet noir</i>	PVC negro Black PVC <i>PVC noir</i>
4062	● Negro texturado RAL 9005 Textured black RAL 9005 <i>Noir texturé RAL 9005</i>	■ Cotonet antracita Anthracite cotonet <i>Cotonet anthracite</i>	PVC negro Black PVC <i>PVC noir</i>
4273	● Negro texturado RAL 9005 Textured black RAL 9005 <i>Noir texturé RAL 9005</i>	■ Cotonet blanco White cotonet <i>Cotonet blanc</i>	PVC negro Black PVC <i>PVC noir</i>
4274	● Negro texturado RAL 9005 Textured black RAL 9005 <i>Noir texturé RAL 9005</i>	■ Cotonet sand Sand cotonet <i>Cotonet sable</i>	PVC negro Black PVC <i>PVC noir</i>
4275	● Negro texturado RAL 9005 Textured black RAL 9005 <i>Noir texturé RAL 9005</i>	■ Cotonet gris frío Cold grey cotonet <i>Cotonet gris froid</i>	PVC negro Black PVC <i>PVC noir</i>
4276	● Negro texturado RAL 9005 Textured black RAL 9005 <i>Noir texturé RAL 9005</i>	■ Arenal topo Taupe arenal <i>Arenal taupe</i>	PVC negro Black PVC <i>PVC noir</i>
4277	● Negro texturado RAL 9005 Textured black RAL 9005 <i>Noir texturé RAL 9005</i>	■ Loneta natural Natural cotton <i>Coton naturel</i>	PVC negro Black PVC <i>PVC noir</i>
4278	● Negro texturado RAL 9005 Textured black RAL 9005 <i>Noir texturé RAL 9005</i>	■ Arpillera beige Beige sacking <i>Jute beige</i>	PVC negro Black PVC <i>PVC noir</i>
4279	● Negro texturado RAL 9005 Textured black RAL 9005 <i>Noir texturé RAL 9005</i>	■ Osaka Osaka <i>Osaka</i>	PVC negro Black PVC <i>PVC noir</i>

Arco a textil

Estructura en blanco o negro. Pantalla de loneta, osaka o cotonet. Cable eléctrico de PVC negro.

Black structure. Cotton, sacking, osaka or cotonet lampshade. Black electrical PVC cable.

Structure en noir. Abat-jour en coton, en toile, en osaka ou en cotonet. Câble électrique en PVC noir.



E-27 LED 12W



BIM/3D files: luxcambra.com/3D (3ds, dwg, 3dm, skp, rfa)

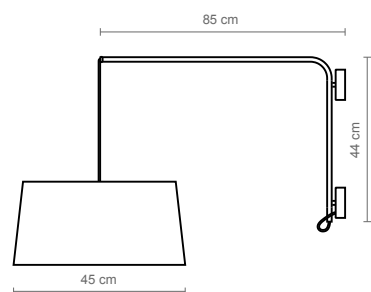

	ESTRUCTURA STRUCTURE STRUCTURE	PANTALLA LAMP SHADE ABAT-JOUR	CABLE CABLE CÂBLE
2548	● Blanco mate texturado RAL 9016 Textured mat white RAL 9016 <i>Blanc mat texturé RAL 9016</i>	■ Osaka Osaka <i>Osaka</i>	PVC negro Black PVC <i>PVC noir</i>
2549	● Blanco mate texturado RAL 9016 Textured mat white RAL 9016 <i>Blanc mat texturé RAL 9016</i>	■ Cotonet gris frío Cold grey cotonet <i>Cotonet gris froid</i>	PVC negro Black PVC <i>PVC noir</i>
2550	● Blanco mate texturado RAL 9016 Textured mat white RAL 9016 <i>Blanc mat texturé RAL 9016</i>	■ Cotonet blanco White cotonet <i>Cotonet blanc</i>	PVC negro Black PVC <i>PVC noir</i>
2552	● Negro texturado RAL 9005 Textured black RAL 9005 <i>Noir texturé RAL 9005</i>	■ Osaka Osaka <i>Osaka</i>	PVC negro Black PVC <i>PVC noir</i>
2553	● Negro texturado RAL 9005 Textured black RAL 9005 <i>Noir texturé RAL 9005</i>	■ Cotonet blanco White cotonet <i>Cotonet blanc</i>	PVC negro Black PVC <i>PVC noir</i>
2554	● Negro texturado RAL 9005 Textured black RAL 9005 <i>Noir texturé RAL 9005</i>	■ Cotonet sand Sand cotonet <i>Cotonet sable</i>	PVC negro Black PVC <i>PVC noir</i>
2555	● Negro texturado RAL 9005 Textured black RAL 9005 <i>Noir texturé RAL 9005</i>	■ Loneta natural Natural cotton <i>Coton naturel</i>	PVC negro Black PVC <i>PVC noir</i>

Arco a Born / Raval / Miramar

Estructura en blanco o negro. Pantalla metálica. Cable eléctrico de PVC negro.

Black or white structure. Metallic lampshade. Black electrical PVC cable.

Structure en noir ou blanc. Abat-jour métallique. Câble électrique en PVC noir.



E-27 LED 12W
(Arco a Miramar)

E-27 Globo LED 12W
(Arco a Raval)



E-27 LED Standard cúpula 6W
E-27 LED Standard dome 6W
E-27 LED Standard dôme 6W
(Arco a Born)

BIM/3D files: luxcambra.com/3D (3ds, dwg, 3dm, skp, rfa)

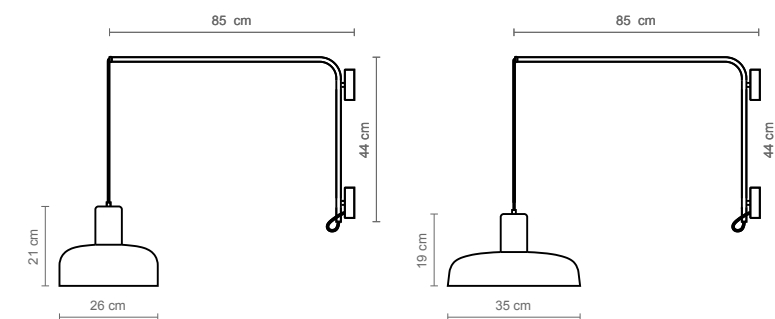

Arco a Miramar 26

Arco a Miramar 35

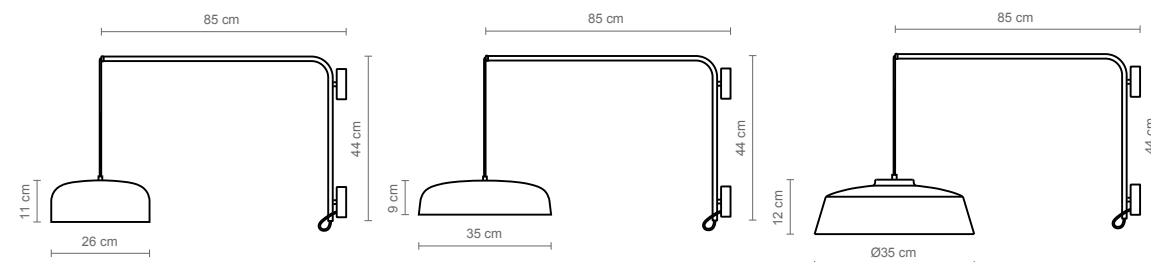

Arco a Born 26

Arco a Born 35

Arco a Raval

	ESTRUCTURA STRUCTURE STRUCTURE	PANTALLA LAMP SHADE ABAT-JOUR	CABLE CABLE CÂBLE
2800 2803 2806 2810 2814	● Blanco roto texturado Textured off-white <i>Blanc cassé texturé</i>	● Blanco roto texturado Textured off-white <i>Blanc cassé texturé</i>	PVC negro Black PVC <i>PVC noir</i>
2801 2804 2807 2811 2815	● Negro texturado Textured black <i>Noir texturé</i>	● Negro texturado Textured black <i>Noir texturé</i>	PVC negro Black PVC <i>PVC noir</i>
2802 2805 2808 2812	● Negro texturado Textured black <i>Noir texturé</i>	● Aluminio pulido brillante Polished aluminium <i>Aluminium poli brillant</i>	PVC negro Black PVC <i>PVC noir</i>

Atlanta

Luxcambra team

La colección Atlanta se basa en el movimiento de un brazo articulado con una rótula en su mitad que permite su rotación, extensión o contracción.

Las lámparas Atlanta resultan ideales como lámparas de lectura.

The Atlanta collection is based on the movement of an articulated arm with a ball joint in its center that allows its rotation, extension or contraction.

Atlanta lamps are ideal as reading lamps.

La collection Atlanta est basée sur le mouvement d'un bras articulé avec une rotule centrale qui permet sa rotation, son extension ou sa contraction.

Les lampes Atlanta sont idéales comme lampes de lecture.

Familia / Family / Famille

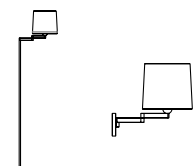

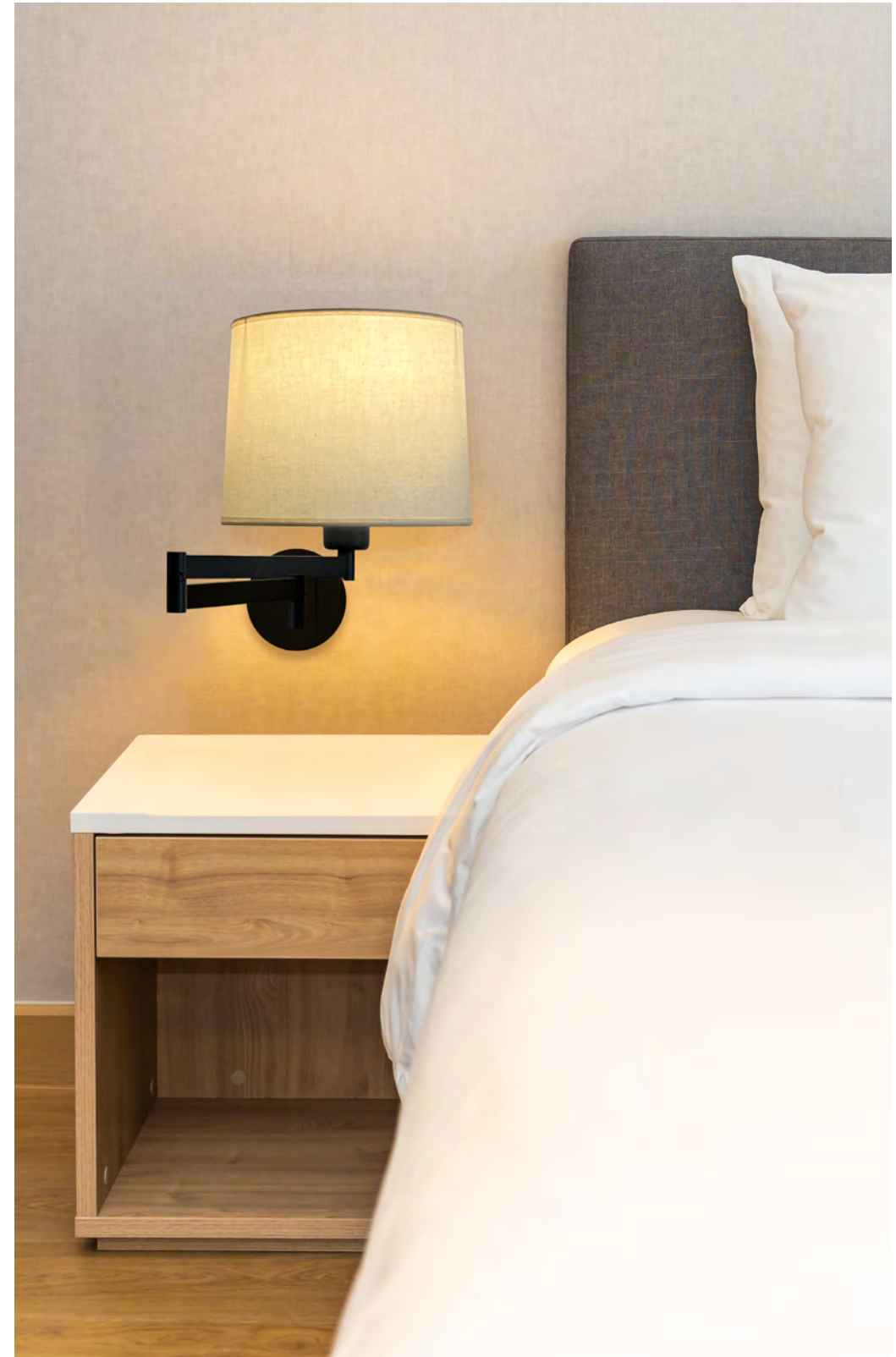

Atlanta a

Estructura en blanco, negro o níquel. Pantalla de loneta, cotonet o screen.

White, black or nickel structure. Cotton, cotonet or screen lampshade.

Structure en blanc, noir ou nickel. Abat-jour en coton, cotonet ou screen.



E-27 LED 12W



BIM/3D files: luxcambra.com/3D (3ds, dwg, 3dm, skp, rfa)

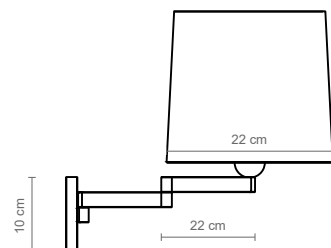

	ESTRUCTURA STRUCTURE STRUCTURE	PANTALLA LAMP SHADE ABAT-JOUR
2116	Níquel Nickel Nickel	Loneta blanca White cotton Coton blanc
2119	Níquel Nickel Nickel	Cotonet blanco White cotonet Cotonet blanc
2124	Blanco mate texturado RAL 9016 Textured mat white RAL 9016 Blanc mat texturé RAL 9016	Cotonet arena oscura Dark sand cotonet Cotonet sable foncé
2542	Blanco mate texturado RAL 9016 Textured mat white RAL 9016 Blanc mat texturé RAL 9016	Cotonet gris frío Cold grey cotonet Cotonet gris froid
2126	Blanco mate texturado RAL 9016 Textured mat white RAL 9016 Blanc mat texturé RAL 9016	Cotonet blanco White cotonet Cotonet blanc
2543	Negro texturado RAL 9005 Textured black RAL 9005 Noir texturé RAL 9005	Cotonet blanco White cotonet Cotonet blanc
2544	Negro texturado RAL 9005 Textured black RAL 9005 Noir texturé RAL 9005	Cotonet sand Sand cotonet Cotonet sable
2545	Negro texturado RAL 9005 Textured black RAL 9005 Noir texturé RAL 9005	Screen beige Beige screen Screen beige

Atlanta p

Estructura en blanco, negro o níquel. Pantalla de loneta, cotonet o screen. Cable eléctrico PVC negro o transparente.

White, black or nickel structure. Cotton, cotonet or screen lampshade. Black electrical PVC cable or transparent.

Structure en blanc, noir ou nickel. Abat-jour en coton, cotonet ou screen. Câble électrique PVC noir ou transparent.



E-27 LED 12W



BIM/3D files: luxcambra.com/3D (3ds, dwg, 3dm, skp, rfa)

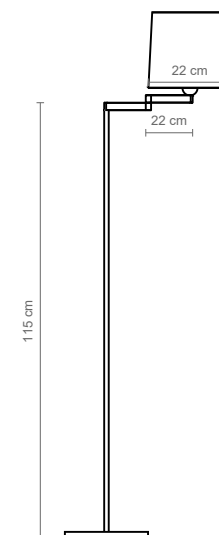

	ESTRUCTURA STRUCTURE STRUCTURE	PANTALLA LAMP SHADE ABAT-JOUR	CABLE CABLE CÂBLE
4063	Níquel Nickel Nickel	Loneta blanca White cotton Coton blanc	Transparente Transparent Transparent
4066	Níquel Nickel Nickel	Cotonet blanco White cotonet Cotonet blanc	Transparente Transparent Transparent
4071	Blanco mate texturado RAL 9016 Textured mat white RAL 9016 Blanc mat texturé RAL 9016	Cotonet arena oscura Dark sand cotonet Cotonet sable foncé	Transparente Transparent Transparent
4211	Blanco mate texturado RAL 9016 Textured mat white RAL 9016 Blanc mat texturé RAL 9016	Cotonet gris frío Cold grey cotonet Cotonet gris froid	Transparente Transparent Transparent
4073	Blanco mate texturado RAL 9016 Textured mat white RAL 9016 Blanc mat texturé RAL 9016	Cotonet blanco White cotonet Cotonet blanc	Transparente Transparent Transparent
4212	Negro texturado RAL 9005 Textured black RAL 9005 Noir texturé RAL 9005	Cotonet blanco White cotonet Cotonet blanc	PVC negro Black PVC PVC noir
4213	Negro texturado RAL 9005 Textured black RAL 9005 Noir texturé RAL 9005	Cotonet sand Sand cotonet Cotonet sable	PVC negro Black PVC PVC noir
4214	Negro texturado RAL 9005 Textured black RAL 9005 Noir texturé RAL 9005	Screen beige Beige screen Screen beige	PVC negro Black PVC PVC noir

Barceloneta

Jordi Llopis

Barceloneta quiere rendir homenaje a las persianas de madera cuando quedaban enrolladas en los balcones que poblaban los barrios de Barcelona. A su vez se inspira en la función que tenían de tamizar la luz una vez desplegadas.

Una pantalla cilíndrica de suspensión en pergamino blanco, beige o encintada en pongé recorre una línea de luz que permite crear diferentes ambientes y tonalidades a su alrededor. Puede colocarse sobre mesas de comedor, despachos o en zonas de estar y paso y funciona tanto sola como formando conjuntos lineales.

Barceloneta wants to pay tribute to the wooden blinds when they were rolled up on the balconies that populated the neighborhoods of Barcelona. At the same time, it is inspired by the function they had to filter the light once they were deployed.

A cylindrical suspension lampshade in white or beige parchment or pongee-ribboned finish extends across a light line that allows you to create different environments and tones all around. It can be placed above dining tables, offices or in living and passage areas and works also both individually and in linear series.

Barceloneta veut rendre hommage aux stores vénitiens en bois lorsqu'ils étaient repliés sur les balcons qui peuplaient les quartiers de Barcelone. Par la même occasion, elle s'inspire de la fonction qu'ils avaient de tamiser l'entrée de lumière une fois déployés.

Un abat-jour cylindrique de suspension en parchemin blanc, beige ou tissu pongé parcourt le long d'une ligne de lumière, ce qui permet de créer aux alentours différents tons et environnements. Elle peut être placée au-dessus de tables à manger, des bureaux ou dans des espaces de vie et de passage et fonctionne aussi bien seule qu'en ensembles linéaires.

Familia / Family / Famille

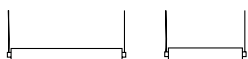







Barceloneta c

Florón en negro. Pantalla de pergamino o encintada. Cable eléctrico PVC negro.

Black ceiling support. Parchment or pongee ribbon lampshade. Black electrical PVC cable.

Support plafond en noir. Abat-jour en parchemin ou tissu en pongé. Câble électrique PVC noir.



Tira LED 16.5W
2079 lm / 2.700K
(Barceloneta 110)



Tira LED 24W
3024 lm / 2.700K
(Barceloneta 160)



BIM/3D files: luxcambra.com/3D (3ds, dwg, 3dm, skp, rfa)

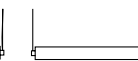
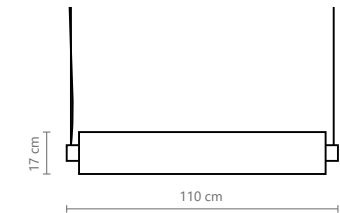
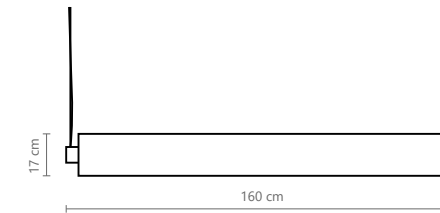

FLORÓN
CEILING SUPPORT
SUPPORT PLAFOND

PANTALLA
LAMP SHADE
ABAT-JOUR

CABLE
CABLE
CÂBLE

1672

1713

● Negro texturado RAL 9005
Textured black RAL 9005
Noir texturé RAL 9005

■ Pergamino blanco
White parchment
Parchemin blanc

■ PVC negro
Black PVC
PVC noir

1673

1714

● Negro texturado RAL 9005
Textured black RAL 9005
Noir texturé RAL 9005

■ Pergamino beige
Beige parchment
Parchemin beige

■ PVC negro
Black PVC
PVC noir

1674

1715

● Negro texturado RAL 9005
Textured black RAL 9005
Noir texturé RAL 9005

■ Encintada pongé
Pongee ribbon
Tissu pongé

■ PVC negro
Black PVC
PVC noir

Born

Jordi Llopis

Las lámparas colgantes Born, con sus dos pantallas redondeadas de diámetros diferentes, deja a la vista una bombilla decorativa con cúpula dorada o plateada. Estas luminarias, por su simplicidad y estilo minimalista, resultan especialmente adecuadas para proyectos de restauración, en cocinas o en espacios de trabajo ya sea de forma individual o seriada. Se fabrica en color negro, blanco y también en aluminio pulido.

The Born hanging lamps, with their two rounded lampshades of different diameters, leave at sight the decorative light bulb with either a gold or silver dome. These luminaires, due to their simplicity and minimalist style, are particularly suitable for restoration projects, kitchens or work spaces, either individually or in series. It can be produced in black, white or polished aluminum.

Les suspensions Born, avec ses deux abat-jours arrondis de diamètres différents, rendent visibles l'ampoule décorative avec un dôme doré ou argenté. Ces luminaires, en raison de leur simplicité et de leur style minimaliste, sont particulièrement adaptés pour les projets de restauration, les cuisines ou les espaces de travail, que ce soit individuellement ou en séries. Elles sont fabriquées en noir, blanc ou en aluminium poli.

Familia / Family / Famille







Born

Florón en negro o blanco. Pantalla de pergamino o encintada. Cable eléctrico de PVC negro.

Black or white ceiling support. Parchment or pongee ribbon lampshade. Black electrical PVC cable.

Support plafond en noir ou blanc. Abat-jour en parchemin ou tissu en pongé. Câble électrique PVC noir.



E-27 LED Standard cúpula 6W
E-27 LED Standard dome 6W
E-27 LED Standard dôme 6W



BIM/3D files: luxcambra.com/3D (3ds, dwg, 3dm, skp, rfa)

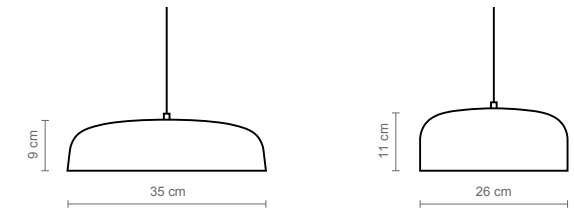

		FLORÓN CEILING SUPPORT SUPPORT PLAFOND	PANTALLA LAMP SHADE ABAT-JOUR	CABLE CABLE CÂBLE
1675	1678	● Negro texturado Textured black <i>Noir texturé</i>	● Negro texturado RAL 9005 Textured black RAL 9005 <i>Noir texturé RAL 9005</i>	PVC negro Black PVC <i>PVC noir</i>
1676	1679	● Blanco roto texturado Off-white textured <i>Blanc cassé texturé</i>	● Blanco roto texturado RAL 9002 Off-white textured RAL 9002 <i>Blanc cassé texturé RAL 9002</i>	PVC negro Black PVC <i>PVC noir</i>
1677	1680	● Negro texturado Textured black <i>Noir texturé</i>	● Aluminio pulido brillante Polished aluminium <i>Aluminium poli brillant</i>	PVC negro Black PVC <i>PVC noir</i>

Calma

Bruno de Ávila

La adaptabilidad y el confort acústico son los principales resultados de la lámpara Calma.

Producida con una combinación de materiales sostenibles de origen local, Calma aporta lo mejor de la tecnología y la naturaleza. Las elegantes tablas flotantes se esculpen en un proceso de cero residuos, ya que los desechos se transforman de nuevo en corcho.

Los tableros de corcho son ajustables, creando un interesante juego de luces y sombras en las ondas del material. Esta textura también mejora la absorción del ruido, contribuyendo a crear un ambiente sofisticado y relajante.

Esta lámpara tiene una estructura en corcho acústico, un foco de madera de haya y una tija de latón satinado.

Adaptability and acoustic comfort are the main outcomes of Calma lamp.

Produced with a combination of locally sourced sustainable materials, Calma brings the best of technology and nature. The elegant floating boards are sculpted in a zero-waste process, as the residues are transformed into cork again.

The cork boards are regulable creating an interesting light and shadow play into the waves of the material. This texture also enhances the noise absorption, contributing to a sophisticated and relaxing environment.

This lamp has an acoustic cork structure, a spot of natural beech wood and a thin tube of satin brass.

L'adaptabilité et le confort acoustique sont les principaux résultats de la lampe Calma.

Produite à partir d'une combinaison de matériaux durables d'origine locale, Calma offre le meilleur de la technologie et de la nature. Les élégantes planches flottantes sont sculptées selon un processus sans déchets, les résidus étant retransformés en liège.

Les planches de liège sont réglables, ce qui crée un jeu d'ombre et de lumière intéressant dans les rainures du matériau. Cette texture améliore également l'absorption du bruit, contribuant ainsi à un environnement sophistiqué et relaxant.

Cette lampe a une structure en liège acoustique, un spot en bois de hêtre naturel et une tige de laiton satiné.

Familia / Family / Famille





Nuestra lámpara Calma diseñada por Bruno de Ávila ganó el premio de Archiproducts Design Awards, con la mención especial de “Sustainability Design Awards” 2022 que celebra productos que se destacaron en términos de uso de materiales naturales o reciclados, técnicas de producción que reducen las emisiones contaminantes y mínimo impacto ambiental durante todo el ciclo de vida del producto.

También ha sido finalista en el Prêmio design MCB del Museu da Casa Brasileira y presentada en el Premi Catalunya d'Ecodisseny 2023 que reconoce productos diseñados, fabricados o ejecutados en Catalunya que integren en su diseño consideraciones para mejorar el comportamiento ambiental.

Our Calma hanging lamp designed by Bruno de Ávila won the Archiproducts Sustainability Award 2022 for its unique concept, celebrating products that stood out in terms of use of natural and recycled materials, production techniques that reduce polluting emissions, and minimum environmental impact during the product's entire life cycle.

It was also finalist at the Prêmio design MCB selection del Museu da Casa Brasileira and was presented to the Premi Catalunya d'Ecodisseny 2023 which values products designed, manufactured and developed in Catalunya considering better environmental behavior during the all design process.

Notre suspension Calma conçue par Bruno de Ávila a gagné le prix de Archiproducts Sustainability Award 2022 pour son concept unique en termes d'usage de matériaux naturels ou recyclés, techniques de production qui réduisent les émissions de contamination et un minimum impact environnemental durant tout le cycle de vie du produit.

Elle a également été finaliste du Prêmio design MCB del Museu da Casa Brasileira et présentée au Premi Catalunya d'Ecodisseny 2023 qui met en valeur les produits conçus, fabriqués et exécutés en Catalogne pour leur intégration dans le design d'une conscience environnementale durant tout le processus du luminaire.





Panel decorativo de corcho acústico sin foco.
Decorative acoustic cork panel without spotlight.
Panneau acoustique décoratif en liège sans spot.

Altura del disco ajustable a través de la pieza de madera.
Disc height adjustable through the piece of wood.
Hauteur du disque réglable à travers la pièce de bois.





Corcho oscuro 100% natural
100% natural dark cork
100% liège foncé naturel



Corcho claro 98% natural con un 2% de colas biodegradables exentas de formaldehidos
98% natural light cork with 2% formaldehyde-free biodegradable glues
98% liège clair naturel avec 2% de colles biodégradables sans formaldéhyde

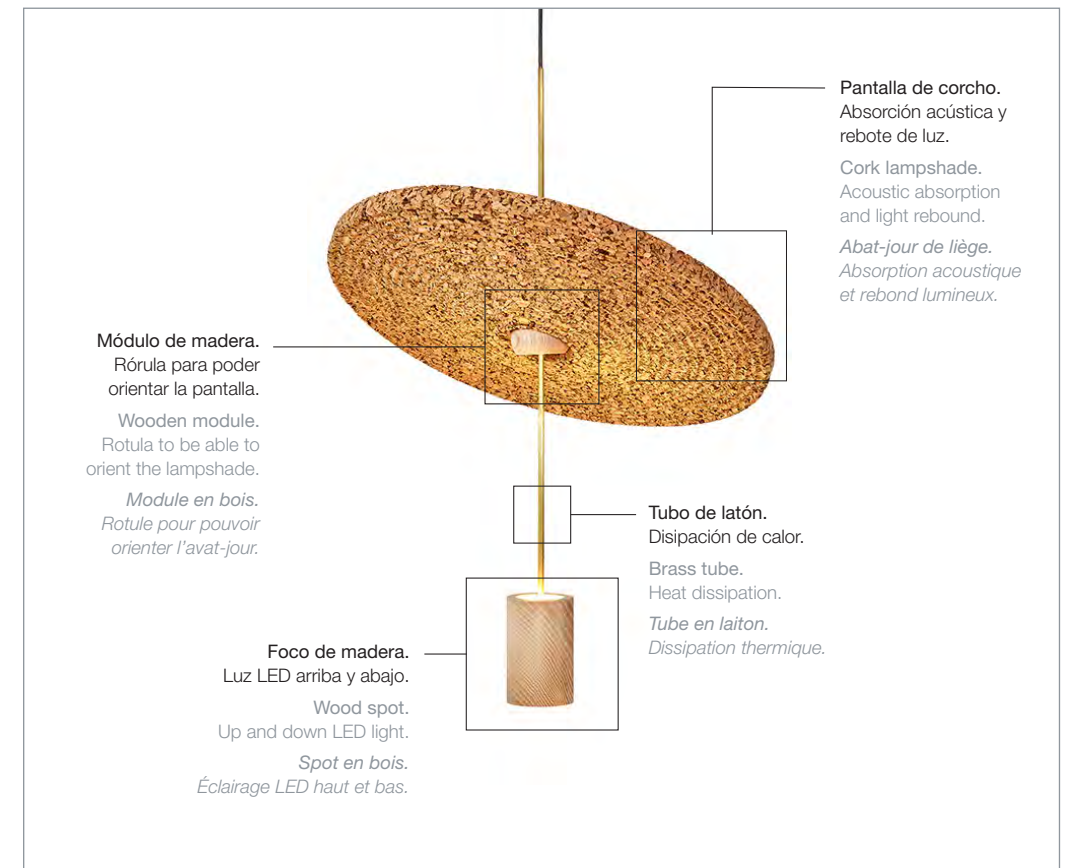



La madera de haya utilizada para la fabricación de la lámpara proviene de la reforestación. Por otro lado, los alcornoques y las hayas de los que se obtienen el corcho y la madera absorben CO₂ durante su crecimiento.

The beech wood used to produce the lamp comes from reforestation. On the other hand, cork oaks and beeches from which cork and wood are obtained can absorb CO₂ during their growth.

Le bois de hêtre utilisé pour fabriquer la lampe est issu de reforestation. D'autre part, les chênes-lièges et les hêtres à partir desquels le liège et le bois sont obtenus absorbent du CO₂ au cours de leur croissance.



Todos los residuos de corcho generados durante el proceso de producción se reciclan.

All cork waste generated during the production process is recycled.

Tous les déchets de liège générés pendant le processus de production sont recyclés.



Calma

Pantalla en corcho acústico, foco de madera de haya con aceite natural y tija de latón satinado. Florón en negro. Cable de algodón negro. También se puede utilizar el panel de corcho sin luz como elemento decorativo y para matizar el sonido en composiciones para proyectos de iluminación. Cable eléctrico de algodón negro.

Acoustic cork lampshade, beech wood spotlight with natural oil and satin brass tube. Black ceiling support. Black cotton cable. The cork panel without lightsource can also be used as a decorative element to tone the sound in compositions for lighting projects. Black electrical cotton cable.

Abat-jour acoustique en liège, spot en bois d'hêtre en huile naturelle et tige en laiton satiné. Support plafond en noir. Câble en coton noir. Le panneau de liège peut également être utilisé comme élément décoratif pour atténuer le son dans les projets d'illumination. Câble électrique en coton noir.



2 x LED 6,3W
W665-836 lm / 2.700 K



BIM/3D files: luxcambra.com/3D (3ds, dwg, 3dm, skp, rfa)

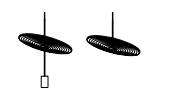
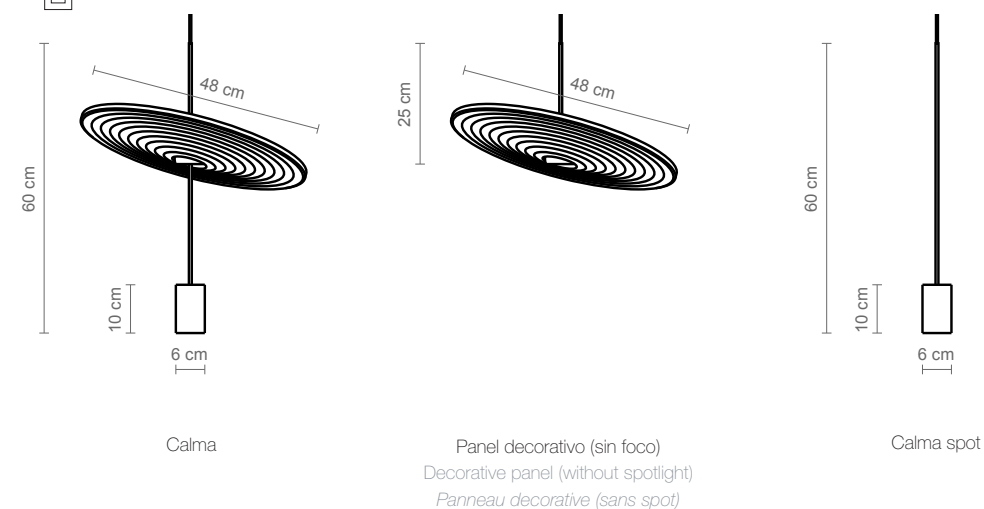

ESTRUCTURA
STRUCTURE
STRUCTURE

PANTALLA
LAMP SHADE
ABAT-JOUR

CABLE
CABLE
CÂBLE

1622 1624

Latón y madera de haya
Satin brass and beech wood
Laiton satiné et bois d'hêtre

Corcho acústico claro
Light acoustic cork
Liège acoustique clair

Algodón negro
Black cotton
Coton noir

1623 1625

Latón y madera de haya
Satin brass and beech wood
Laiton satiné et bois d'hêtre

Corcho acústico oscuro
Dark acoustic cork
Liège acoustique sombre

Algodón negro
Black cotton
Coton noir

1626

Latón y madera de haya
Satin brass and beech wood
Laiton satiné et bois d'hêtre

Algodón negro
Black cotton
Coton noir

Capuchina

Luxcambra team

Las lámparas Capuchina son uno de nuestros best sellers. Con sus pantallas metálicas cónicas se presenta en múltiples acabados. En la lámpara de pie, sobremesa y aplique sus rótulas permiten articular los brazos verticalmente y la pantalla a derecha e izquierda.

Se trata de una pieza muy versátil y decorativa y apropiada tanto para uso doméstico como para proyectos contract.

The Capuchina lamps are one of our best-sellers. Its metal cone shades are available in various finishes. For the floor lamp, table lamp and wall lamp, its joints allow you to orientate the arms vertically as well as moving the shade from left to right.

It is a versatile and decorative product, suitable for both domestic use and hospitality projects.

Les lampes Capuchina font partie de nos best-sellers. Ses abat-jours métalliques coniques sont disponibles en divers finitions. Pour la lampe de pied, la lampe de table et l'applique, les rotules permettent d'articuler les bras verticalement ainsi qu'orienter l'abat-jour de gauche à droite.

Il s'agit d'un modèle très polyvalent et décoratif, autant pour l'usage domestique que pour des projets d'HORECA.

Familia / Family / Famille

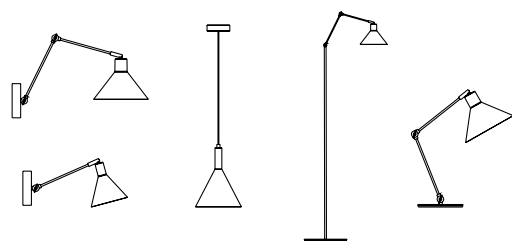









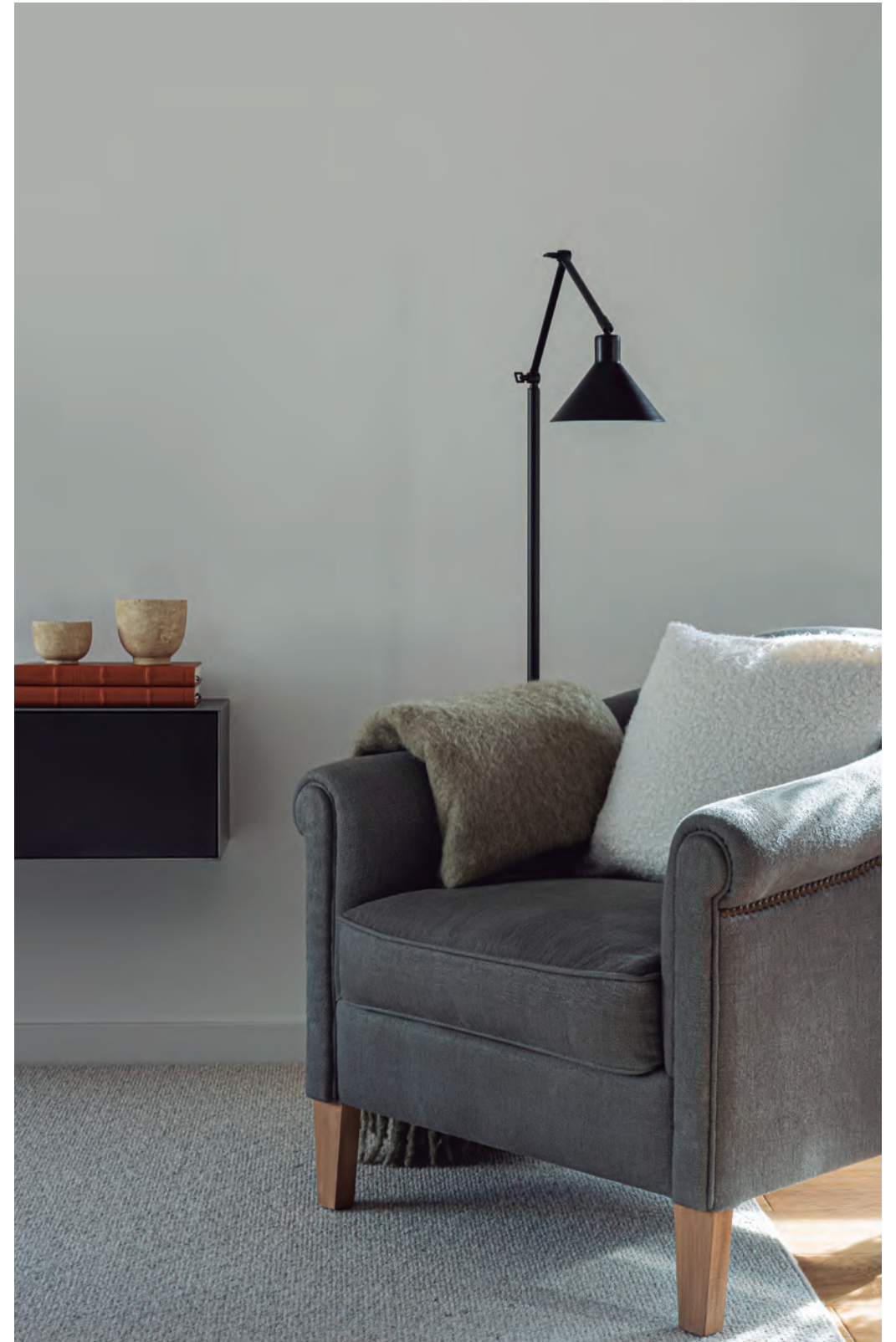



Capuchina a

Estructura y pantalla en blanco o negro.

Black or white ceiling support and shade.

Support et abat-jour en noir ou blanc.



E-14 LED 12W



BIM/3D files: luxcambra.com/3D (3ds, dwg, 3dm, skp, rfa)

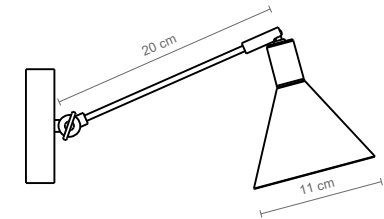

Capuchina a 1

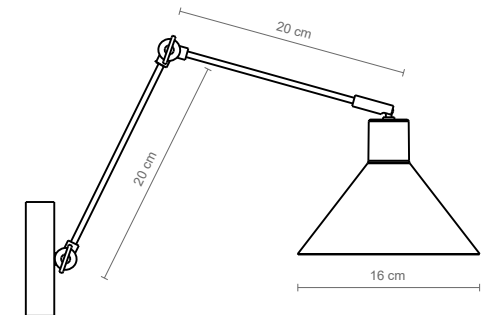

Capuchina a 2



ESTRUCTURA
STRUCTURE
STRUCTURE

PANTALLA
LAMP SHADE
ABAT-JOUR

2182

2184

● Negro texturado
Textured black
Noir texturé

● Negro texturado RAL 9005
Textured black RAL 9005
Noir texturé RAL 9005

2457

2458

● Blanco mate texturado
Textured matt white
Blanc texturé mat

● Blanco mate texturado RAL 9016
Textured matt RAL 9016
Blanc texturé mat RAL 9016

2588

2589

● Blanco roto texturado
Off-white textured
Blanc cassé texturé

● Blanco roto texturado RAL 9002
Off-white textured RAL 9002
Blanc cassé texturé RAL 9002

Capuchina c

Florón en blanco o negro. Pantalla en negro y dorado, negro y blanco o RAL. Cable eléctrico de algodón negro.

Black or white ceiling support. Black and gold, black and white or RAL lampshade. Black electrical cotton cable.

Support plafond en noir ou blanc. Abat-jour en noir et doré, noir et blanc ou RAL. Câble électrique en coton noir.



E-14 LED 12W



BIM/3D files: luxcambra.com/3D (3ds, dwg, 3dm, skp, rfa)

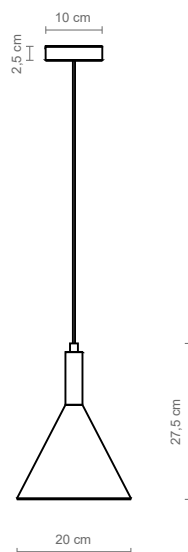

	FLORÓN CEILING SUPPORT SUPPORT PLAFOND	PANTALLA LAMP SHADE ABAT-JOUR	CABLE CABLE CÂBLE
1246	● Negro texturado Textured black <i>Noir texturé</i>	● Negro/dorado Black/gold <i>Noir/doré</i>	● Algodón negro Black cotton <i>Coton noir</i>
1247	● Negro texturado Textured black <i>Noir texturé</i>	● Negro/blanco Black/white <i>Noir/blanc</i>	● Algodón negro Black cotton <i>Coton noir</i>
1249	● Blanco mate texturado Textured matt white <i>Blanc texturé mat</i>	● Blanco mate texturado RAL 9016 Textured matt RAL 9016 <i>Blanc texturé mat RAL 9016</i>	● Algodón negro Black cotton <i>Coton noir</i>
1511	● Blanco roto texturado Off-white textured <i>Blanc cassé texturé</i>	● Blanco roto texturado RAL 9002 Off-white textured RAL 9002 <i>Blanc cassé texturé RAL 9002</i>	● Algodón negro Black cotton <i>Coton noir</i>
1358	● Color RAL RAL color <i>Couleur RAL</i>	● Color RAL RAL color <i>Couleur RAL</i>	● Algodón negro Black cotton <i>Coton noir</i>

Capuchina s / Capuchina p

Estructura y pantalla en blanco o negro. Cable eléctrico de PVC negro.

Black or white ceiling support and shade. Black electrical PVC cable.

Support et abat-jour en noir ou blanc. Câble électrique en PVC noir.



E-14 LED 12W



BIM/3D files: luxcambra.com/3D (3ds, dwg, 3dm, skp, rfa)

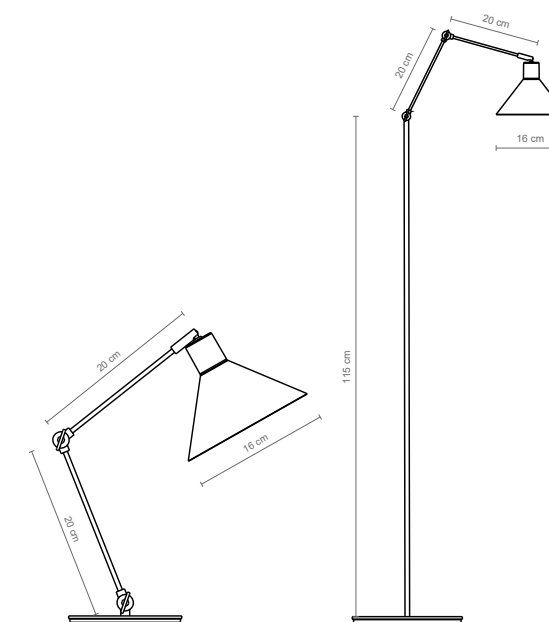

Capuchina s

Capuchina p

	ESTRUCTURA STRUCTURE STRUCTURE	PANTALLA LAMP SHADE ABAT-JOUR	CABLE CABLE CÂBLE
3028	● Negro texturado Textured black <i>Noir texturé</i>	● Negro texturado RAL 9005 Textured black RAL 9005 <i>Noir texturé RAL 9005</i>	● PVC negro Black PVC <i>PVC noir</i>
3194	● Blanco mate texturado Textured matt white <i>Blanc texturé mat</i>	● Blanco mate texturado RAL 9016 Textured matt RAL 9016 <i>Blanc texturé mat RAL 9016</i>	● PVC negro Black PVC <i>PVC noir</i>
3195	● Blanco roto texturado Off-white textured <i>Blanc cassé texturé</i>	● Blanco roto texturado RAL 9002 Off-white textured RAL 9002 <i>Blanc cassé texturé RAL 9002</i>	● PVC negro Black PVC <i>PVC noir</i>

Champignon

Benditas Studio

Champignon es una fuente de luz simple y funcional inspirada en la forma de una seta en crecimiento. La lámpara crea escenarios esculturales y elegantes, combinando lo poético y lo práctico en un mismo producto.

Champignon ofrece versatilidad y se puede configurar sólo o en compañía de otros «Champiñones», proporcionando un carácter contemporáneo adecuado para hoteles, hogares y oficinas.

Champignon is a simple and functional light source, inspired by the growth stages of a mushroom. The lamp creates elegant and sculptural design scenarios, as it combines poetry and functionality within the product.

Champignon is versatile and can be installed either individually or in series of “mushrooms” to add a modern touch for hotels, offices or homes.

La collection Champignon a une source de lumière simple et fonctionnelle, inspirée de la forme d'un champignon en croissance. Le luminaire crée des scénarios architecturaux élégants, en combinant un aspect poétique et un aspect fonctionnel dans le design même du produit.

La lampe Champignon est polyvalente et peut être installée seule ou combinée en séries de « champignons » pour ajouter une touche contemporaine à des hôtels, bureaux ou maisons.



archiproducts
DESIGN AWARDS

WINNER 2020

Familia / Family / Famille

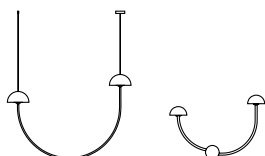









Champignon a / Champignon c

Estructura en blanco, negro o latón satinado. Cable eléctrico de PVC negro.

Black, white or satin brass structure. Black electrical PVC cable.

Structure en noir, blanc ou laiton satiné. Câble électrique en PVC noir.



2 x PCB LED 3,5W
420 lm / 2.700 K
(Champignon a)



2 x PCB LED 6,3W
720 lm / 2.700 K
(Champignon c)



BIM/3D files: luxcambra.com/3D (3ds, dwg, 3dm, skp, rfa)

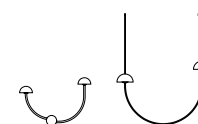
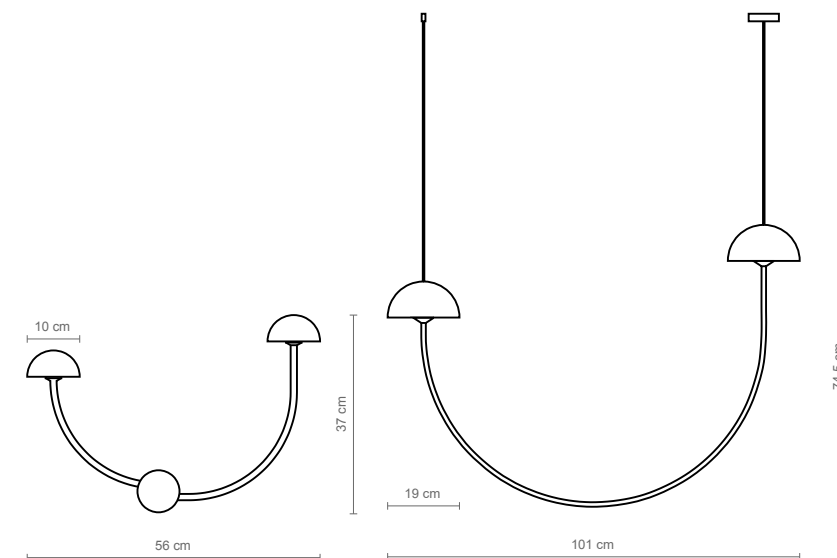

	ESTRUCTURA STRUCTURE STRUCTURE	CARACTERÍSTICAS ELÉCTRICAS ELECTRICAL CHARACTERISTICS CARACTÉRISTIQUES ÉLECTRIQUES	CABLE CABLE CÂBLE
2359	● Blanco mate texturado Textured matt white <i>Blanc texturé mat</i>	2 x PCB LED 3,5W	
2360	● Negro texturado Textured black <i>Noir texturé</i>	2 x PCB LED 3,5W	
2361	● Latón satinado Satin brass <i>Laiton satiné</i>	2 x PCB LED 3,5W	
1335	● Blanco mate texturado Textured matt white <i>Blanc texturé mat</i>	2 x PCB LED 6,3W	PVC negro Black PVC <i>PVC noir</i>
1336	● Negro texturado Textured black <i>Noir texturé</i>	2 x PCB LED 6,3W	PVC negro Black PVC <i>PVC noir</i>
1337	● Latón satinado Satin brass <i>Laiton satiné</i>	2 x PCB LED 6,3W	PVC negro Black PVC <i>PVC noir</i>

Cilindre

Joan Antoni Blanc 1966

Las lámparas CILINDRE se crearon en el año 1966 por Joan Antoni Blanc. Este diseño considera la esencia de una pantalla que tiene la función de difundir la luz, y se complementa con una estructura o soporte para situar esta fuente lumínica en el espacio. En la versión actual, con la intención de aportar al conjunto más calidez, hemos incorporado un sutil perfil de madera de fresno en la parte trasera para situar el portalámparas.

The lamps CILINDRE were originally created in 1966 by Joan Antoni Blanc. This design explores the essence of a lampshade which has the function of diffusing light, and be complemented by a structure or support to place this light source into the space. In this new version, we have incorporated a subtle ash wood profile on the back to place the lampholder.

Les lampes CILINDRE ont été créées en 1966 par Joan Antoni Blanc. Ce design considère l'essence d'un abat-jour qui a pour fonction de diffuser la lumière, et est complété par une structure ou un support pour placer cette source lumineuse dans l'espace. Dans la version actuelle de 2022, pour donner encore plus d'harmonie à l'ensemble, nous avons incorporé un subtil profil en bois de frêne à l'arrière pour incorporer la douille.

Familia / Family / Famille

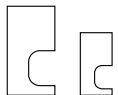

Selección Premio Delta ADI-FAD, 1966.
Selection Delta Award ADI-FAD, 1966.
Sélection Prix Delta ADI-FAD, 1966.







Cilindre

Estructura en madera de fresno y pantalla de metacrilato. Cable eléctrico transparente.

Ash wood structure and methacrylate lampshade. Transparent electrical cable.



Structure en bois de frêne et abat-jour en méthacrylate.
Câble électrique transparent.



E-27 LED 12W



BIM/3D files: luxcambra.com/3D (3ds, dwg, 3dm, skp, rfa)

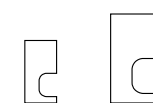
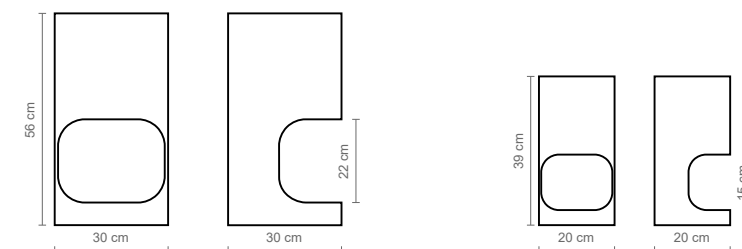

3240

3241

ESTRUCTURA
STRUCTURE
STRUCTURE

Madera de fresno
Ash wood
Bois de frêne

PANTALLA
LAMP SHADE
ABAT-JOUR

Metacrilato blanco opal
Opal white methacrylate
Méthacrylate opal blanc

CABLE
CABLE
CÂBLE

Transparente
Transparent
Transparent

Cim

Estudi Manel Molina

Las lámparas de la colección Cim están fabricadas con pantallas de materiales ligeros y las dimensiones generosas de su volumen cónico le atorgan carácter.

La luz proyectada por la pantalla y el difusor en un único cuerpo nos remite a los ámbitos de iluminación más profesionales. La atmósfera resultante de esta combinación es el factor más destacable y principal del diseño.

En sus diferentes versiones, suspensión, aplique y plafón, el plano continuo de su difusor se percibe ligero y la luz directa que proyecta es uniforme, sin estridencias. Las sombras que resultan son suaves. En contraste, la luz ambiental emitida por la pantalla genera una atmósfera serena, amable y relajada que envuelve todo el entorno.

The lamps from the Cim collection are made with light materials for its shades and the generous dimensions of its conical volume give personality to the collection.

The light projected by the shade and the diffuser in a single element reminds us of the most professional lighting environments. The atmosphere resulting from this combination is the main remarkable factor of this design.

In its different versions, hanging lamp, wall lamp and ceiling lamp, the continuous plane of its diffuser is slightly perceived and the direct light projected is uniform, without any stridency. The shadows resulting from this are soft. In contrast, the ambient light emitted by the shade generates a serene, friendly and relaxed atmosphere that warms the entire environment.

Les lampes de la collection Cim sont réalisées avec des abat-jours en matériaux légers dont les dimensions généreuses de son volume conique lui donnent du caractère.

La lumière projetée par l'abat-jour et le diffuseur dans un seul ensemble nous rappelle les environnements d'éclairage les plus professionnels. L'atmosphère résultante de cette combinaison est le facteur le plus remarquable et principal de la conception.

Dans ses différentes versions, suspension, applique et plafonnier, le plan continu de son diffuseur se perçoit légèrement et la lumière directe qu'il projette est uniforme, sans stridence. Les ombres résultantes sont discrètes. En revanche, la lumière ambiante émise par l'abat-jour génère une atmosphère sereine, conviviale et relaxante qui enveloppe tout l'environnement.

Familia / Family / Famille

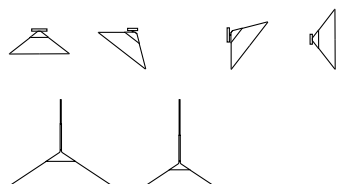







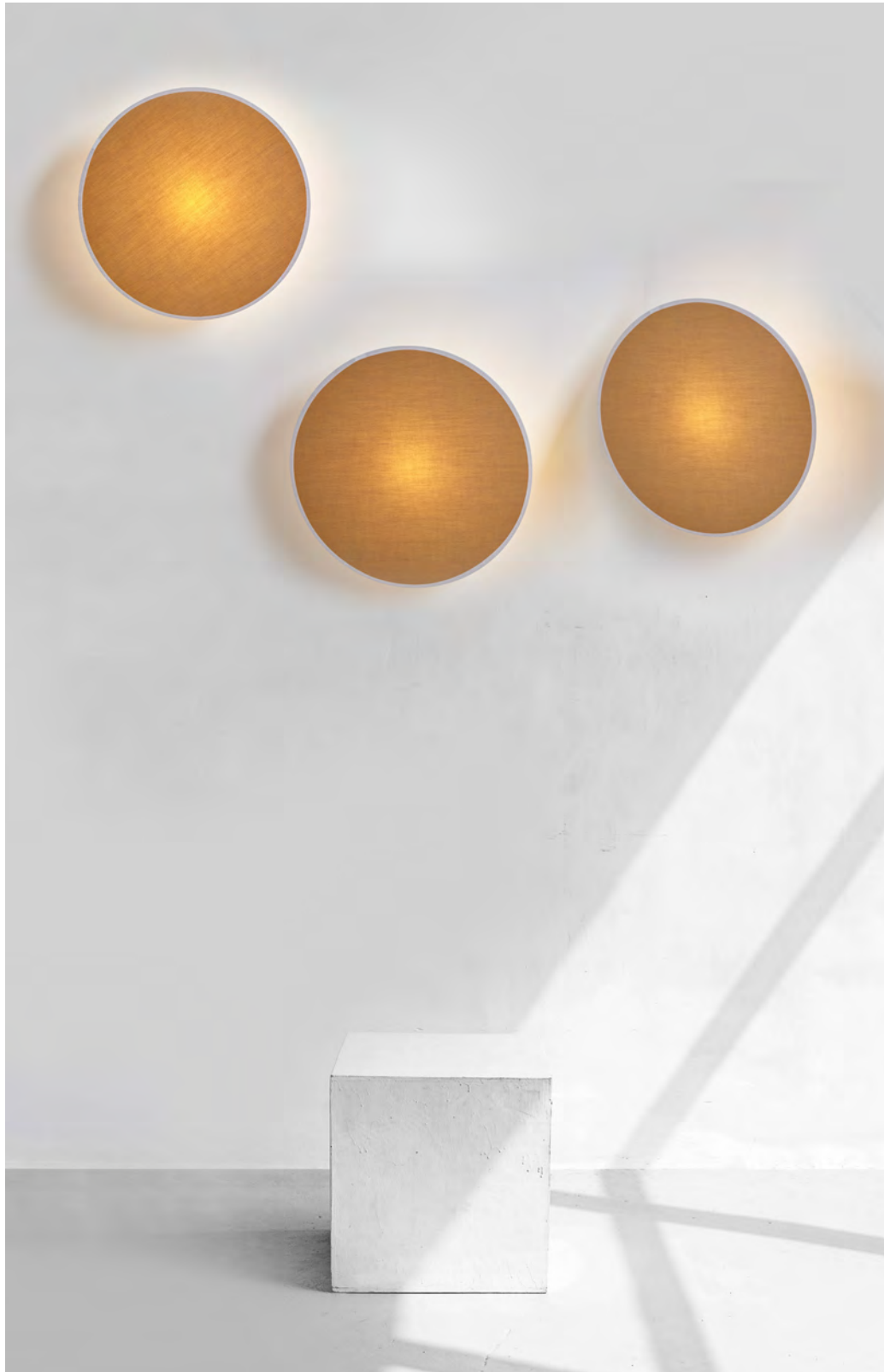

Los apliques y plafones Cim pueden ser fijos o bien orientables a través de una rótula que permite un giro de casi 360°. Las distintas combinaciones de las pantallas permiten crear un juego de luces directas e indirectas en función de las distintas opacidades y colores de las telas. El movimiento permite focalizar la luz según las necesidades de cada ambiente.

Cim wall lamps and ceiling lamps can be fixed or adjustable through a ball joint that allows a rotation of almost 360°. The different combinations of the shades allow to create a play between direct and indirect light depending on the different opacities and fabric colors. The movement is a way to focus the light according to the needs of each environment.

Les appliques et plafonniers Cim peuvent être fixes ou orientables grâce à une rotule qui permet une rotation de presque 360°. Les différentes combinaisons des abat-jours permettent de créer un jeu de lumière directe et indirecte selon les différentes opacités et couleurs des tissus. Le mouvement sert à focaliser la lumière en fonction des besoins de chaque environnement.

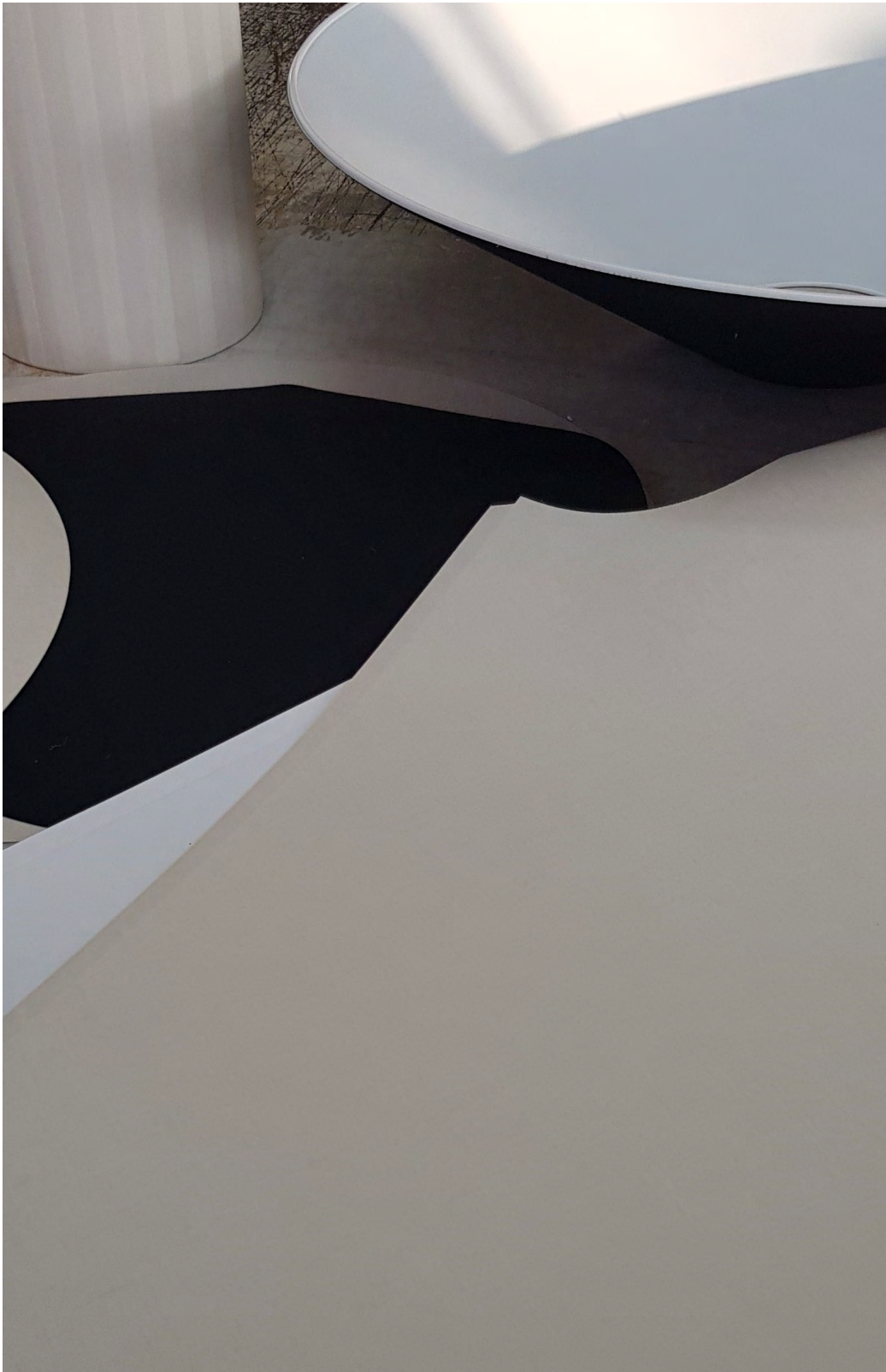

Las pantallas estan fabricadas con un innovador sistema de costura interna invisible en el que no se solapa la tela, evitando de esta manera sombras una vez iluminada.

The lampshades are produced with an innovative internal and invisible seam system in which the fabric does not overlap to avoid any shadows once turned on.

Les abat-jours sont fabriqués avec un nouveau système innovant interne de couture avec lequel le rabat du tissu est invisible, évitant ainsi des ombres une fois allumés.



El difusor de las pantallas permite crear diferentes ambientes en función de su opacidad, y junto con la pantalla da a la colección una gran versatilidad.

The diffuser of the lampshades allows to create different environments depending on its opacity and jointly with the shade the collection has a great versatility.

Le diffuseur des abat-jours permet de créer différents ambiances en fonction de son opacité et joint à l'abat-jour, la collection obtient une grande versatilité.

Cim a / Cim pl

Estructura en negro o blanco. Pantalla de cotonet.
Esta lámpara puede funcionar como aplique o como plafón. Puede ser orientable con rótula o fija.

Black or white structure. Cotonet lampshade. This lamp functions as a wall lamp or ceiling lamp. It can be oriented with a joint ball or fixed.

Structure en noir ou blanc. Abat-jour en cotonet. Cette lampe fonctionne comme une applique ou plafonnier, soit orientable avec une rotule ou fixe.



E-27 LED 8W
Bombilla led esférica
Led spherical bulb
Ampoule led sphérique



BIM/3D files: luxcambra.com/3D (3ds, dwg, 3dm, skp, rfa)

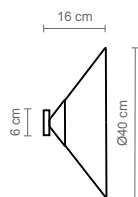

Cim a fijo

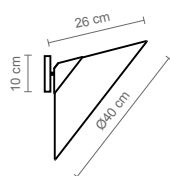

Cim a rótula

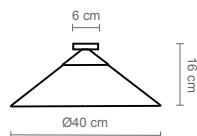

Cim pl fijo

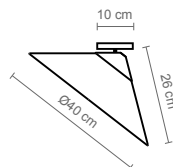

Cim pl rótula

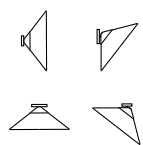

		ESTRUCTURA STRUCTURE STRUCTURE	PANTALLA LAMP SHADE ABAT-JOUR
2816	2822	● Blanco roto texturado RAL 9002 Off-white textured RAL 9002 <i>Blanc cassé texturé RAL 9002</i>	■ Cotonet sand Sand cotonet <i>Cotonet sable</i>
2817	2823	● Blanco roto texturado RAL 9002 Off-white textured RAL 9002 <i>Blanc cassé texturé RAL 9002</i>	■ Cotonet negro Black cotonet <i>Cotonet noir</i>
2818	2824	● Blanco roto texturado RAL 9002 Off-white textured RAL 9002 <i>Blanc cassé texturé RAL 9002</i>	■ Cotonet arena oscura Dark sand cotonet <i>Cotonet sable foncé</i>
2819	2825	● Negro texturado RAL 9005 Textured black RAL 9005 <i>Noir texturé RAL 9005</i>	■ Cotonet sand Sand cotonet <i>Cotonet sable</i>
2820	2826	● Negro texturado RAL 9005 Textured black RAL 9005 <i>Noir texturé RAL 9005</i>	■ Cotonet negro Black cotonet <i>Cotonet noir</i>
2821	2827	● Negro texturado RAL 9005 Textured black RAL 9005 <i>Noir texturé RAL 9005</i>	■ Cotonet arena oscura Dark sand cotonet <i>Cotonet sable foncé</i>

Cim c

Estructura en negro o blanco. Pantalla de cotonet.
Cable eléctrico de algodón negro.

Black or white structure. Cotonet lampshade.
Black electrical cotton cable.

Structure en noir ou blanc. Abat-jour en cotonet. Câble électrique en coton noir.



E-27 LED 12W



BIM/3D files: luxcambra.com/3D (3ds, dwg, 3dm, skp, rfa)

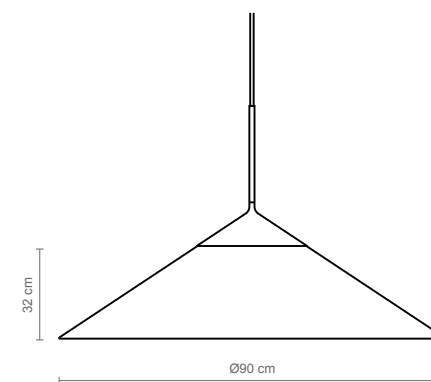

Cim c XL

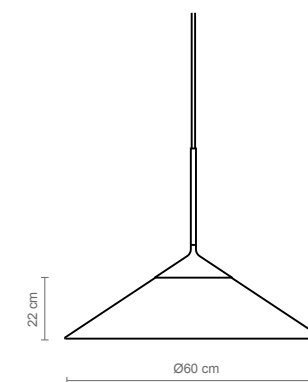

Cim c L

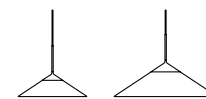

		ESTRUCTURA STRUCTURE STRUCTURE	PANTALLA LAMP SHADE ABAT-JOUR	CABLE CABLE CÂBLE
1681	1685	● Blanco roto texturado RAL 9002 Textured off-white RAL 9002 <i>Blanc cassé texturé RAL 9002</i>	■ Cotonet sand Sand cotonet <i>Cotonet sable</i>	● Algodón negro Black cotton <i>Coton noir</i>
1682	1686	● Blanco roto texturado RAL 9002 Textured off-white RAL 9002 <i>Blanc cassé texturé RAL 9002</i>	■ Cotonet negro Black cotonet <i>Cotonet noir</i>	● Algodón negro Black cotton <i>Coton noir</i>
1683	1687	● Negro texturado RAL 9005 Textured black RAL 9005 <i>Noir texturé RAL 9005</i>	■ Cotonet sand Sand cotonet <i>Cotonet sable</i>	● Algodón negro Black cotton <i>Coton noir</i>
1684	1688	● Negro texturado RAL 9005 Textured black RAL 9005 <i>Noir texturé RAL 9005</i>	■ Cotonet negro Black cotonet <i>Cotonet noir</i>	● Algodón negro Black cotton <i>Coton noir</i>

Clipam

Jordi Llopis

La lámpara Clipam exprime al máximo las posibilidades del juego entre una plancha de hierro en plano con los diferentes pliegues en los que cada uno de ellos tiene una función específica para dar valor entre la forma y la función. Esta lámpara que funciona en diversos entornos y usos, donde la combinación de acabados entre estructura y pantalla permite tener diferentes ambientes.

The Clipam lamp expresses the maximum possibilities of combinations between a flat iron plate with different folds in which each one has a specific function in order to give value between the form and the function. This lamp can work in various environments and uses, where the diversity of finishes between structure and shades allows you to create different environments.

La lampe Clipam explore au maximum les possibilités du jeu entre une plaque de fer plate aux différentes plissures dans lesquelles chacune d'entre elles a une fonction spécifique pour donner de la valeur entre forme et fonction. Cette lampe fonctionne dans divers environnements et utilisations, où la combinaison de finitions entre la structure et l'abat-jour permet des contrastes très différents.



Delta Finalist
ADI Awards
2016









Clipam

Estructura en negro, blanco o terracota. Pantalla de cotonet. Cable eléctrico transparente.

Black, white or terracotta structure. Cotonet lampshade. Transparent electrical cable.

Structure en noir, blanc ou terracotta. Abat-jour en cotonet. Câble électrique transparent.



E-14 LED 12W



BIM/3D files: luxcambra.com/3D (3ds, dwg, 3dm, skp, rfa)

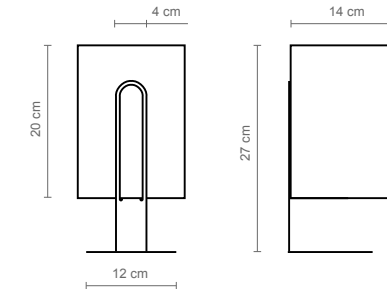

ESTRUCTURA STRUCTURE STRUCTURE

PANTALLA LAMP SHADE ABAT-JOUR

3242	● Blanco RAL 9002 White RAL 9002 Blanc 9002	■ Cotonet blanco White cotonet Cotonet blanc
3243	● Blanco RAL 9002 White RAL 9002 Blanc 9002	■ Cotonet sand Sand Cotonet Cotonet sand
3244	● Blanco RAL 9002 White RAL 9002 Blanc 9002	■ Cotonet gris frío Cold gray cotonet Cotonet gris froid
3245	● Blanco RAL 9002 White RAL 9002 Blanc 9002	■ Cot. arena osc. Dark sand cot. Cot. sable foncé
3246	● Blanco RAL 9002 White RAL 9002 Blanc 9002	■ Cotonet siena Sienna cotonet Cotonet sienne
3247	● Negro RAL 9005 Black RAL 9005 Noir 9005	■ Cotonet blanco White cotonet Cotonet blanc
3248	● Negro RAL 9005 Black RAL 9005 Noir 9005	■ Cotonet sand Sand Cotonet Cotonet sand
3249	● Negro RAL 9005 Black RAL 9005 Noir 9005	■ Cotonet gris frío Cold gray cotonet Cotonet gris froid
3250	● Negro RAL 9005 Black RAL 9005 Noir 9005	■ Cot. arena osc. Dark sand cot. Cot. sable foncé
3251	● Negro RAL 9005 Black RAL 9005 Noir 9005	■ Cotonet siena Sienna cotonet Cotonet sienne
3252	● Terracota RAL Design 050-40-50 Terracotta	■ Cotonet blanco White cotonet Cotonet blanc
3253	● Terracota RAL Design 050-40-50 Terracotta	■ Cotonet sand Sand Cotonet Cotonet sand
3254	● Terracota RAL Design 050-40-50 Terracotta	■ Cotonet gris frío Cold gray cotonet Cotonet gris froid
3255	● Terracota RAL Design 050-40-50 Terracotta	■ Cot. arena osc. Dark sand cot. Cot. sable foncé
3256	● Terracota RAL Design 050-40-50 Terracotta	■ Cotonet siena Sienna cotonet Cotonet sienne

Conica

Joan Antoni Blanc 1965

La lámpara de suspensión CÓNICA, Delta de Oro ADI-FAD 1965, fue la primera que creó Joan Antoni Blanc como diseñador industrial. Se hicieron varias versiones de ella a lo largo del tiempo, hasta el año 2006, en el que se dejó de producir. Ahora, con esta actualización, queremos recuperar el espíritu inicial de un modelo icónico respetando sus características funcionales y su punto esencial: el mecanismo de fijación de la fuente de luz con la pantalla. La conicidad de su forma permite además apilar dos elementos con este único mecanismo de fijación, para formar conjuntos de diversas tonalidades cromáticas que garantizan una reflexión lumínica neutra y un exterior de color para aportar más calidez ambiental. Y lo hacemos utilizando materiales más sostenibles, como el metacrilato reciclado para el elemento difusor, y otros más actuales, como el aluminio anodizado para los complementos estructurales.



Premio Delta de Oro ADI-FAD, 1965.

Gold Delta Award ADI-FAD, 1965.

Prix Delta d'Or ADI-FAD, 1965.



The CÓNICA hanging lamp, Delta de Oro ADI-FAD 1965, was the first model created by Joan Antoni Blanc as an industrial designer. Several versions of it were made over time, until 2006, when it was discontinued. Nowadays with this re-edition, we want to recover the initial spirit of an iconic model while respecting its functional characteristics and its essential point: the fixing mechanism of the light source with the shade. The conicity of its form allows to stack two elements with a single fixing mechanism to form sets of various chromatic color tones keeping the interior white to guarantee neutral light reflection and a colored exterior to provide more ambient warmth.

We are using more sustainable materials, such as recycled methacrylate for the diffuser element, and other more modern parts, such as anodized aluminum for the structural accessories.

La lampe de suspension CÓNICA, Delta d'Or ADI-FAD 1965, a été le premier modèle créé par Joan Antoni Blanc en tant que designer industriel. Plusieurs versions de celle-ci ont été faites au fil du temps, jusqu'en 2006, date à laquelle la collection a été abandonnée. Désormais, avec cette réédition, nous souhaitons retrouver l'esprit initial d'un modèle iconique tout en respectant ses caractéristiques fonctionnelles et son point essentiel : le mécanisme de fixation de la source lumineuse avec l'abat-jour. La conicité de sa forme permet également d'assembler deux éléments avec un mécanisme de fixation unique, qui forme des ensembles de différentes tonalités chromatiques de couleur, en gardant l'intérieur blanc pour garantir un reflet neutre de la lumière et un extérieur coloré qui crée plus de chaleur ambiante. Nous utilisons des matériaux plus durables, comme le méthacrylate recyclé pour l'élément diffuseur, et d'autres plus récents, comme l'aluminium anodisé pour les accessoires structurels.







“El jurado de los premios de aquel año destacó la novedad del mecanismo de fijación de la fuente de luz con la pantalla, que permitía liberarla de la instalación eléctrica sin necesidad de ninguna herramienta para facilitar su limpieza. También señaló que la conicidad de la pantalla ofrecía la posibilidad de apilar dos elementos con un único mecanismo de fijación, lo que permitía formar conjuntos de diversas tonalidades cromáticas manteniendo el interior blanco para garantizar una reflexión lumínica neutra y un exterior de color que hacía posible la creación de conjuntos con más calidez ambiental. A lo largo de mi trayectoria profesional he diseñado muchas lámparas de techo, sobremesa, pie y apliques, y la mayoría de sus pantallas han seguido una geometría troncoconica. Considero que la conicidad y apertura de la pantalla dirigen de forma adecuada la proyección de la luz, y que la calidad translúcida del material permite una difusión lumínica tranquila y eficiente, con una sencillez y discreción formal que tiene la virtud de integrarse armónicamente en cualquier espacio o estilo arquitectónico.”

“The jury for that year’s awards highlighted the novelty of the fixing mechanism of the light source to the shade, which allowed to release it from the electrical installation without the need for any tool to facilitate cleaning. They also pointed out that the conicity of its form allows to stack two elements with a single fixing mechanism to form sets of various chromatic color tones keeping the interior white to guarantee neutral light reflection and a colored exterior to provide more ambient warmth. Throughout my professional career I have designed many ceiling, table, floor and wall lamps, and most of the lampshades have included a frusto-conical geometry. I believe that the conicity and opening of the shade adequately direct the projection of light, and that the translucent quality of the material allows a calm and efficient diffusion with simplicity and formal discretion. This aspect allows to integrate it harmoniously into any space or architectural style.”



« Le jury des prix de cette année-là a souligné la nouveauté du mécanisme de fixation de la source lumineuse avec l’abat-jour, qui permettait de la libérer de l’installation électrique sans avoir besoin d’aucun outil pour faciliter son nettoyage. Ils ont également indiqué que la conicité de sa forme permet également d’assembler deux éléments avec un mécanisme de fixation unique, qui forme des ensembles de différentes tonalités chromatiques de couleur, en gardant l’intérieur blanc pour garantir un reflet neutre de la lumière et un extérieur coloré qui crée plus de chaleur ambiante.

Tout au long de ma carrière professionnelle, j’ai conçu de nombreuses lampes de plafond, de table, de pied et appliques murales, et la plupart des abat-jours ont suivi une géométrie tronconique. Je crois que la conicité et l’ouverture de l’abat-jour dirigent adéquatement la projection de la lumière, et la qualité translucide du matériau permet une diffusion calme et efficace de la lumière, avec une simplicité et une discrétion formelle qui a la vertu de s’intégrer harmonieusement dans n’importe quel espace ou style architectural. »

En 1966, la primera sede de la escuela de diseño Eina, la casa Manuel Dolcet, ubicada en el barrio de Sarrià de Barcelona, y las nuevas oficinas de la emblemática tienda Vinçon, incorporaron la luz de suspensión Cónica en sus dependencias como fuente de luz principal de los distintos espacios de estudio y trabajo.

In 1966, the first headquarters of the Eina design school, the Manuel Dolcet house, located in the Sarrià neighborhood of Barcelona, and the new offices of the emblematic Vinçon store, incorporated the Cónica hanging lamp as the principal light source of their different study and work spaces.

En 1966, le premier siège de l'école de design Eina, la maison Manuel Dolcet, située dans le quartier Sarrià de Barcelone, et les nouveaux bureaux de l'emblématique magasin Vinçon, incorporent la suspension Cónica dans leurs espaces comme source lumineuse principale des différentes zones d'études et de travail.



Oficinas Vinçon / Vinçon offices / Des bureaux Vinçon

Foto: Museu del Disseny de Barcelona. Fons Vinçon



Lámpara Conica en Vinçon, un referente barcelonés de la modernidad aplicada a la decoración y el mobiliario del hogar.
Conica Lamp in Vinçon, a Barcelona benchmark of modernity applied to decoration and home furnishings.
Lampe Conica à Vinçon, référence barcelonaise de la modernité appliquée à la décoration et à l'ameublement.

Foto: Museu del Disseny de Barcelona. Fons Vinçon



Conica

Estructura en negro. Pantalla de metacrilato. Cable eléctrico de algodón negro.

Black structure. Methacrylate lampshade. Black electrical cotton cable.



E-27 LED 12W

Structure en noir. Abat-jour en méthacrylate. Câble électrique en coton noir.



BIM/3D files: luxcambra.com/3D (3ds, dwg, 3dm, skp, rfa)

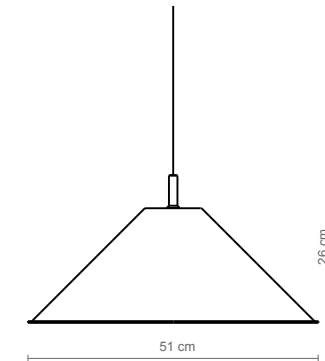

	ESTRUCTURA STRUCTURE STRUCTURE	PANTALLA LAMP SHADE ABAT-JOUR	CABLE CABLE CÂBLE
1628	● Negro texturado RAL 9005 Textured black RAL 9005 <i>Noir texturé RAL 9005</i>	■ Metacrilato blanco opal Opal white methacrylate <i>Méthacrylate opal blanc</i>	Algodón negro Black cotton <i>Coton noir</i>
1629	● Negro texturado RAL 9005 Textured black RAL 9005 <i>Noir texturé RAL 9005</i>	■ Metacrilato verde opal Opal green methacrylate <i>Méthacrylate opal vert</i>	Algodón negro Black cotton <i>Coton noir</i>
1630	● Negro texturado RAL 9005 Textured black RAL 9005 <i>Noir texturé RAL 9005</i>	■ Metacrilato gris opal Opal grey methacrylate <i>Méthacrylate opal gris</i>	Algodón negro Black cotton <i>Coton noir</i>
1631	● Negro texturado RAL 9005 Textured black RAL 9005 <i>Noir texturé RAL 9005</i>	■ Metacrilato rojo opal Opal red methacrylate <i>Méthacrylate opal rouge</i>	Algodón negro Black cotton <i>Coton noir</i>

Creta

Xavier Solé

Lámpara colgante fabricada en madera natural de roble barnizada.

La naturaleza esconde riquezas que los diseñadores estamos tentados de asimilar a nuestros diseños. En este caso, basándonos en la observación de la forma de un producto muy cercano a nosotros, una Oliva, hemos creado la lámpara CRETA.

Su forma contundente es perfecta para disipar el calor de la tecnología LED sin necesidad de añadir radiadores ni terceras piezas entre los dos.

Hanging lamp made of natural varnished oak wood.

Nature is full of wonders and a source of inspiration for the designers to create new shades. Here, Xavier Solé recreated the form of an olive to design the CRETA hanging lamp.

Its organic form is perfect for dispelling the heat of LED technology, without needing to add any heat sinks or third parts between the two components.

Suspension en chêne naturel vernie.

La nature regorge de richesses qui ne cessent d'être des sources d'inspiration pour les designers. Ici, Xavier Solé a reproduit la forme d'une olive pour son modèle CRETA.

Sa forme organique est parfaite pour dissiper la chaleur de la technologie LED, sans qu'il soit nécessaire d'ajouter des dissipateurs thermiques ou autres pièces entre les deux composants.





Creta

Florón en negro. Pantalla de madera de roble. Cable eléctrico de algodón negro.

Black ceiling support. Oak wood lampshade. Black electrical cotton cable.

Support plafond en noir. Abat-jour en bois de chêne.

Câble électrique en coton noir.



GU-10 LED 8W



BIM/3D files: luxcambra.com/3D (3ds, dwg, 3dm, skp, rfa)

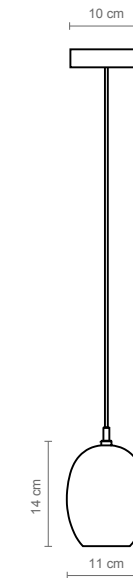

FLORÓN
CEILING SUPPORT
SUPPORT PLAFOND

PANTALLA
LAMP SHADE
ABAT-JOUR

CABLE
CABLE
CÂBLE

1030

● Negro texturado RAL 9005
Textured black RAL 9005
Noir texturé RAL 9005

■ Madera de roble
Oak wood
Bois de chêne

Algodón negro
Black cotton
Coton noir

Cuadro

Luxcambra Team

Los plafones Cuadro destacan por la variedad de materiales de sus pantallas. Cada uno de ellos aporta una personalidad y una luz diferente, cálida y rica en matices. Cada uno de los materiales humaniza y da carácter al espacio con su sola presencia. Pensando en su uso para lugares públicos, ofrecemos la posibilidad de fabricarla en grandes formatos.

The Cuadro ceiling lamps stand out for the variety of materials available for its shades. Each of them creates a different personality by bringing different warm and nuanced light effects. Each one of the materials humanizes and gives character to the space by itself. As its design was thought to be used in public spaces, we offer the possibility of manufacturing them in large sizes.

Les plafonniers Cuadro se distinguent par la variété de matériaux disponibles pour les abat-jours. Chacune finition apporte une personnalité et une lumière chaleureuse et riche en nuances. Chacun des matériaux humanise et donne du caractère à l'espace par sa présence. Comme leur design a été conçu pour les lieux publics, nous offrons également la possibilité de les fabriquer en grands formats.







Cuadro

Pantalla de lino, loneta, arpillera, osaka o cotonet.
Sistema de sujeción magnético. Medidas especiales disponibles para proyectos (hasta 150 cm).

Linen, sacking, osaka or cotonet lampshade. Magnetic clamping system. Special sizes available for projects (until 150 cm).

Abat-jour en lin, coton, osaka ou cotonet. Système magnétique de fixation. Mesures spéciales disponibles pour projets (jusqu'à 150 cm).



3 x E-27 LED 12W



BIM/3D files: luxcambra.com/3D (3ds, dwg, 3dm, skp, rfa)

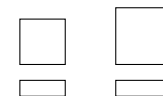
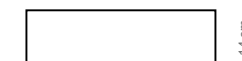
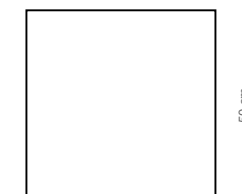
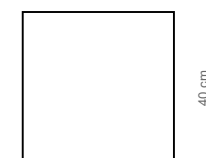

PANTALLA
LAMP SHADE
ABAT-JOUR

1524	1526		Lino blanco White linen <i>Lin blanc</i>
1103	1116		Loneta natural Natural cotton <i>Coton naturel</i>
1104	1117		Loneta blanca White cotton <i>Coton blanc</i>
1105	1118		Osaka
1106	1119		Arpillera beige Beige sacking <i>Toile beige</i>
1107	1120		Saco Sack <i>Jute</i>
1525	1527		Cotonet sand Sand cotonet <i>Cotonet sand</i>
1109	1122		Arenal topo Taupe arenal <i>Arenal taupe</i>
1110	1123		Cot. arena oscuro Dark sand cot. <i>Cot. sable sombre</i>
1111	1124		Cotonet blanco White cotonet <i>Cotonet blanc</i>
1112	1125		Cotonet beige Beige cotonet <i>Cotonet beige</i>
1113	1126		Cotonet negro Black cotonet <i>Cotonet noir</i>
1114	1127		Cotonet antracita Anthracite cotonet <i>Cotonet anthracite</i>

Corba

Luxcambra Team

El aplique Corba es funcional y versátil. Su versión con un potente foco lector de luz LED resulta ideal como aplique para el cabecero de la cama en hoteles.

The Corba model is functional and versatile. Its version with a powerful LED reader is ideal as a bedside wall light in hotels.

Le modèle Corba est fonctionnel et polyvalent. Sa version avec un puissant lecteur LED est idéale comme applique de chevet dans les chambres d'hôtels.

Familia / Family / Famille

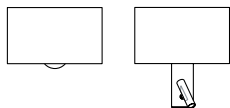











Corba / Corba U

Estructura en blanco o negro. Pantalla de cotonet, encintada o hum.

Structure in white or black. Cotonet, ribbon or hum lampshade.

Structure en blanc ou noir. Abat-jour en cotonet, tissu ou hum.



E-27 LED 12W



BIM/3D files: luxcambra.com/3D (3ds, dwg, 3dm, skp, rfa)

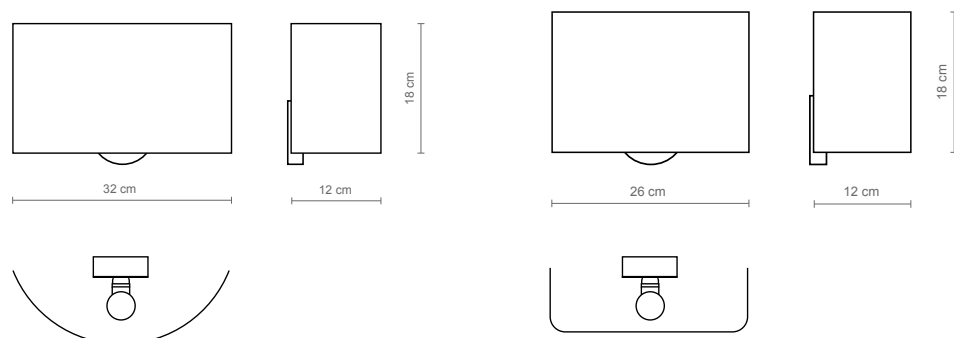

		ESTRUCTURA STRUCTURE STRUCTURE	PANTALLA LAMP SHADE ABAT-JOUR
2828	2848	● Blanco roto texturado RAL 9002 Off-white textured RAL 9002 <i>Blanc cassé texturé RAL 9005</i>	■ Cotonet sand Sand cotonet <i>Cotonet sable</i>
2829	2849	● Blanco roto texturado RAL 9002 Off-white textured RAL 9002 <i>Blanc cassé texturé RAL 9002</i>	■ Cotonet gris frío Cold grey cotonet <i>Cotonet gris froid</i>
2830	2850	● Blanco roto texturado RAL 9002 Off-white textured RAL 9002 <i>Blanc cassé texturé RAL 9002</i>	■ Encintada pongé Pongee ribbon <i>Tissu pongé</i>
2831	2851	● Blanco roto texturado RAL 9002 Off-white textured RAL 9002 <i>Blanc cassé texturé RAL 9002</i>	■ Encintada algodón Cotton ribbon <i>Tissu coton</i>
2832	2852	● Blanco roto texturado RAL 9002 Off-white textured RAL 9002 <i>Blanc cassé texturé RAL 9002</i>	■ HUM Hum <i>Hum</i>
2833	2853	● Negro texturado RAL 9005 Textured black RAL 9005 <i>Noir texturé RAL 9005</i>	■ Cotonet sand Sand cotonet <i>Cotonet sable</i>
2834	2854	● Negro texturado RAL 9005 Textured black RAL 9005 <i>Noir texturé RAL 9005</i>	■ Cotonet gris frío Cold grey cotonet <i>Cotonet gris froid</i>
2835	2855	● Negro texturado RAL 9005 Textured black RAL 9005 <i>Noir texturé RAL 9005</i>	■ Encintada pongé Pongee ribbon <i>Tissu pongé</i>
2836	2856	● Negro texturado RAL 9005 Textured black RAL 9005 <i>Noir texturé RAL 9005</i>	■ Encintada algodón Cotton ribbon <i>Tissu coton</i>
2837	2857	● Negro texturado RAL 9005 Textured black RAL 9005 <i>Noir texturé RAL 9005</i>	■ HUM Hum <i>Hum</i>

Corba lector / Corba U lector

Estructura en blanco o negro. Pantalla de cotonet, encintada o hum.

Structure in white or black. Cotonet, ribbon or hum lampshade.

Structure en blanc ou noir. Abat-jour en cotonet, tissu ou hum.



E-27 LED 12W



LED 3W

150 lm / 2.700K



BIM/3D files: luxcambra.com/3D (3ds, dwg, 3dm, skp, rfa)

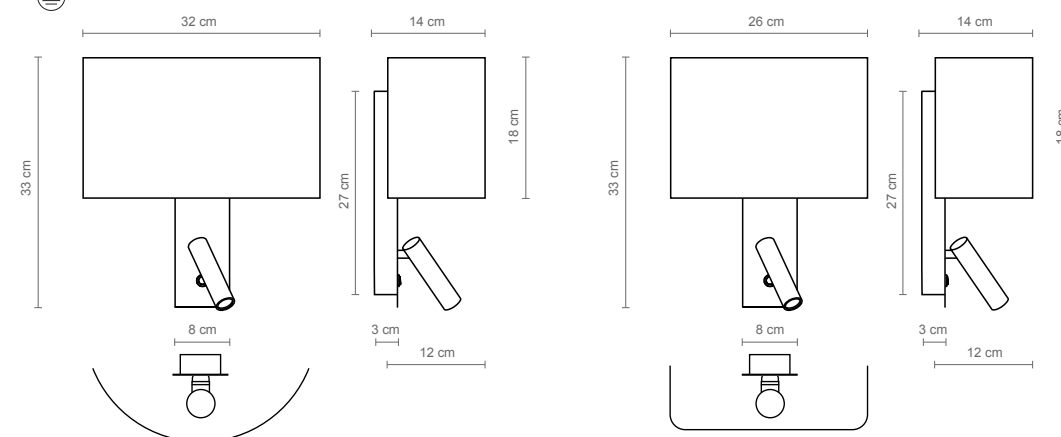

		ESTRUCTURA STRUCTURE STRUCTURE	PANTALLA LAMP SHADE ABAT-JOUR
2838	2859	● Blanco roto texturado RAL 9002 Off-white textured RAL 9002 <i>Blanc cassé texturé RAL 9005</i>	■ Cotonet sand Sand cotonet <i>Cotonet sable</i>
2839	2860	● Blanco roto texturado RAL 9002 Off-white textured RAL 9002 <i>Blanc cassé texturé RAL 9002</i>	■ Cotonet gris frío Cold grey cotonet <i>Cotonet gris froid</i>
2840	2861	● Blanco roto texturado RAL 9002 Off-white textured RAL 9002 <i>Blanc cassé texturé RAL 9005</i>	■ Encintada pongé Pongee ribbon <i>Tissu pongé</i>
2841	2862	● Blanco roto texturado RAL 9002 Off-white textured RAL 9002 <i>Blanc cassé texturé RAL 9002</i>	■ Encintada algodón Cotton ribbon <i>Tissu coton</i>
2842	2863	● Blanco roto texturado RAL 9002 Off-white textured RAL 9002 <i>Blanc cassé texturé RAL 9002</i>	■ HUM Hum <i>Hum</i>
2843	2864	● Negro texturado RAL 9005 Textured black RAL 9005 <i>Noir texturé RAL 9005</i>	■ Cotonet sand Sand cotonet <i>Cotonet sable</i>
2844	2865	● Negro texturado RAL 9005 Textured black RAL 9005 <i>Noir texturé RAL 9005</i>	■ Cotonet gris frío Cold grey cotonet <i>Cotonet gris froid</i>
2845	2866	● Negro texturado RAL 9005 Textured black RAL 9005 <i>Noir texturé RAL 9005</i>	■ Encintada pongé Pongee ribbon <i>Tissu pongé</i>
2846	2867	● Negro texturado RAL 9005 Textured black RAL 9005 <i>Noir texturé RAL 9005</i>	■ Encintada algodón Cotton ribbon <i>Tissu coton</i>
2847	2868	● Negro texturado RAL 9005 Textured black RAL 9005 <i>Noir texturé RAL 9005</i>	■ HUM Hum <i>Hum</i>

Dual

Xavier Solé

Nuestro aplique Dual se basa en una forma básica y neutral que permite orientar el cuerpo y la luz de una de sus caras hacia donde nos convenga. El producto es camaleónico y puede colocarse tanto en lugares de paso como en dormitorios. Combinando varios apliques podemos conseguir un juego de luces y sombras muy interesante.

Our Dual collection is a new creation of basic wall lamps with adjustable light, as you can rotate the shade from one side to another anytime you want. Thanks to their upward or downward lighting, these wall lamps are ideal to design a play of lights and shadows in hallways, or as reading lamps for bedrooms.

Notre collection d'appliques Dual intègre une forme basique et neutre, qui permet d'orienter le corps et la lumière d'une des facettes de la lampe dans le sens qui vous convient le mieux. Ces appliques modulables créent des jeux de lumières et d'ombres dans un couloir, ou comme lecteur pour une chambre.







Dual

Estructura en blanco o negro.

White or black structure.

Structure en blanc ou noir.



Módulo LED 15W
1.100 lm / 3.000K



BIM/3D files: luxcambra.com/3D (3ds, dwg, 3dm, skp, rfa)

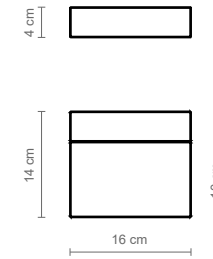

ESTRUCTURA
STRUCTURE
STRUCTURE

CARACTERÍSTICAS ELÉCTRICAS
ELECTRICAL CHARACTERISTICS
CARACTÉRISTIQUES ÉLECTRIQUES

2362

● Blanco mate texturado RAL 9016
Textured matt white RAL 9016
Blanc mat texturé RAL 9016

LED 15W

2363

● Negro texturado RAL 9005
Textured black RAL 9005
Noir texturé RAL 9005

LED 15W

Fanal

Jordi Vilanova 1965

Diseñado por Jordi Vilanova en 1965, su nombre proviene del parecido del modelo con un farol o farol de mano (significado de «fanal» en catalán) con una anilla para poderlo transportar o colgar. Se realizó en dos tamaños, pequeño y grande, y se puede utilizar como lámpara de sobremesa, o de suspensión.

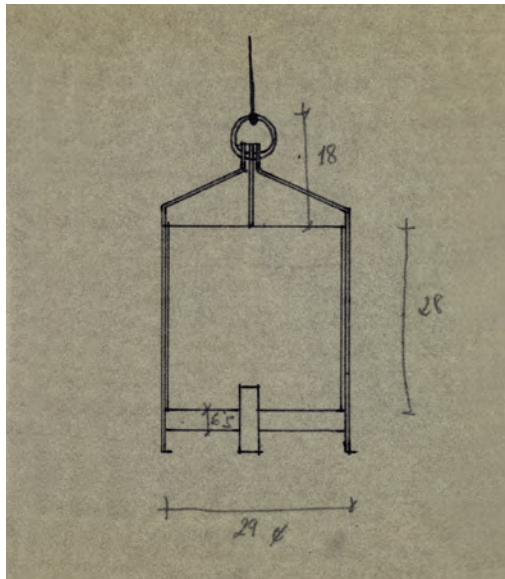

Dibujo de Jordi Vilanova / Drawing by Jordi Vilanova / Dessin de Jordi Vilanova

Foto: Museu del Disseny de Barcelona. Centre de documentació

Familia / Family / Famille

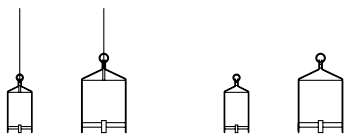

Designed by Jordi Vilanova in 1965, its name comes from the similarity of the model with a lantern or hand lantern (meaning of «fanal» in Catalan) with a grip to be able to transport or hang it. It was made in two sizes, small and large, and can be used as a table or pendant lamp.

Conçu par Jordi Vilanova en 1965, son nom vient de la ressemblance du modèle avec une lanterne ou lanterne à main (signifiant «fanal» en catalan) avec un anneau pour pouvoir la porter ou la suspendre. Il a été fabriqué en deux tailles, petite et grande, et peut être utilisé comme lampe de table.





Los materiales utilizados para su fabricación son metacrilato 100% reciclado para la pantalla y hierro para la estructura.

The materials used for its production are 100% recycled methacrylate for the lampshade and iron for the structure.

Les matériaux utilisés pour sa fabrication sont le méthacrylate 100% recyclé pour l'abat-jour et du fer pour la structure..





Fieles al debate entre artesanía y diseño industrial que determinó de forma inequívoca la carrera de Jordi Vilanova, en nuestra reedición hemos introducido nuevos materiales para las pantallas para potenciar así también el espíritu mediterráneo de la colección.

Remaining faithful to the debate between crafts and industrial design that unequivocally determined Jordi Vilanova's career, in our re-edition we have introduced new materials for the lampshades to also enhance the Mediterranean spirit of the collection.

Fidèles au débat entre l'artisanat et le design industriel qui a marqué sans équivoque la carrière de Jordi Vilanova, nous avons introduit dans notre réédition de nouveaux matériaux pour les abat-jours afin de renforcer également l'esprit méditerranéen de la collection.

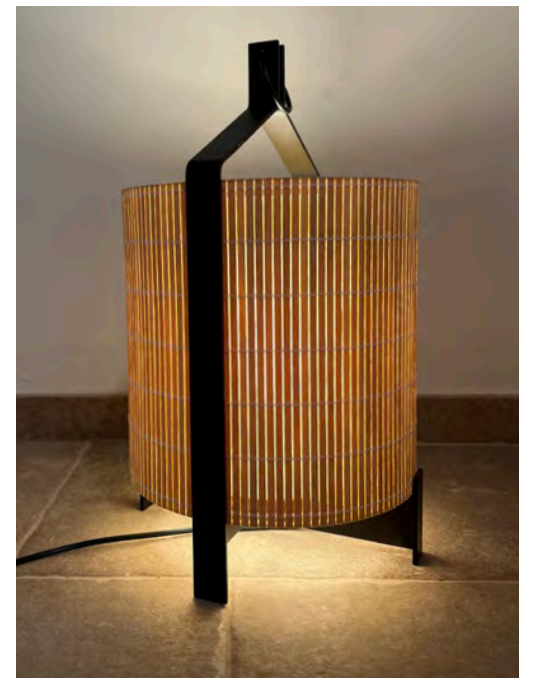



La lámpara de sobremesa Fanal portátil funciona con un módulo led con batería recargable con autonomía de 6 horas.

Fanal portable table lamp functions with a led module with rechargeable battery with 6 hours of autonomy.

La lampe de table Fanal fonctionne avec un module led à batterie rechargeable avec 6 heures d'autonomie.







Jordi Vilanova orientaba sus creaciones bajo los conceptos más actuales de la manera de vivir, dentro de un funcionalismo europeo de acusada influencia escandinava, en el que la lógica del diseño iba siempre respaldado – simplicidad, sobriedad, austeridad, calidad formal y técnica.

Fue referente en el tránsito entre las formas de hacer artesanales y el diseño industrial y se posicionó deliberadamente en un «tercer camino», en busca de una estética moderna de raíces mediterráneas que encajó perfectamente en la idiosincrasia social y técnica de Cataluña.



Fanal 1972

Jordi Vilanova oriented his creations under the most current concepts of lifestyle, within a European functionalism marked by the Scandinavian influence, in which the logic of design was always displayed with simplicity, sobriety, austerity, formal and technical quality.

It was a benchmark in the transition between the ways of making crafts and industrial design and deliberately positioned itself in a “third way”, in search of a new modern aesthetic based on Mediterranean roots that fit perfectly into the social and technical idiosyncrasies of Catalonia.

Jordi Vilanova a orienté ses créations selon les concepts les plus actuels de mode de vie, dans le principe d'un fonctionnalisme européen marqué par l'influence scandinave, dans lequel la logique du design a toujours été soutenue par la simplicité, sobriété, austérité et qualité formelle et technique.

Elle a été une référence dans la transition entre les modes de fabrication artisanale et le design industriel et s'est délibérément positionnée comme une “troisième option”, à la recherche d'une esthétique moderne ancrée dans les racines méditerranéennes, qui s'intègre parfaitement dans les idiosyncrasies sociales et techniques de la Catalogne.

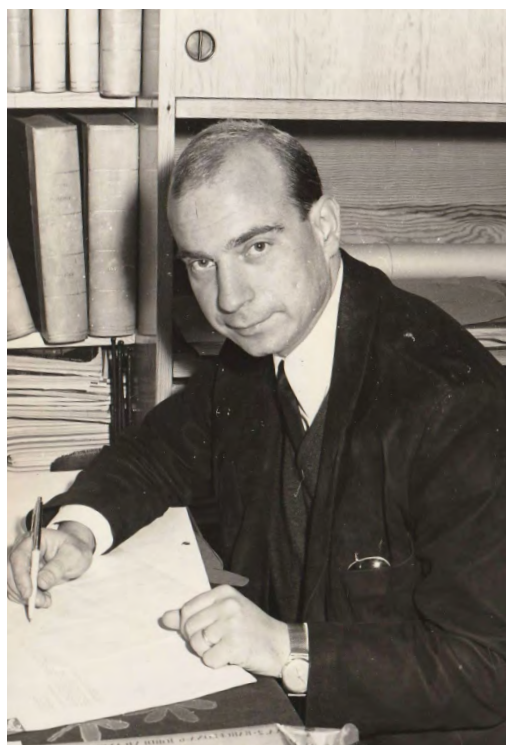

Jordi Vilanova



Photo: Hubette of London and Paris shop, 1968

Por su gran versatilidad, Jordi Vilanova introdujo la lámpara en todo tipo de ambientes: apartamentos en la costa, pisos en la ciudad, casas de montaña, tiendas, oficinas, etc.

Due to its great versatility, Jordi Vilanova introduced the lamp in different types of environments: apartments on the Spanish coast, flats in the city, mountain houses, shops, offices, etc.

En raison de la grande polyvalence du modèle, Jordi Vilanova l'a introduit dans toutes sortes d'environnements : appartements sur la côte catalane, appartements en ville, maisons de montagne, magasins, bureaux, etc.



Foto: Casa Vilanova. Vidrà (Girona), 1969

Fanal c

Estructura en blanco o negro. Pantalla de metacrilato, rafia, cotonet o lamas de madera. Cable eléctrico PVC negro.

White or black structure. Methacrylate, raffia, cottonet or wooden slats lampshade. Black electrical PVC cable.

Structure en blanc ou noir. Abat-jour en méthacrylate, raphia, cotonet ou lames de bois. Cable électrique PVC noir.



E-27 LED 12W



BIM/3D files: luxcambra.com/3D (3ds, dwg, 3dm, skp, rfa)

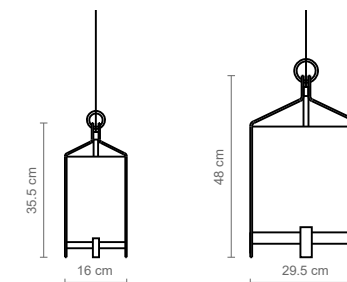

Fanal c S

Fanal c L

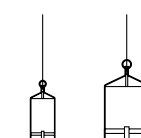

ESTRUCTURA STRUCTURE STRUCTURE		PANTALLA LAMP SHADE ABAT-JOUR	CABLE CABLE CÂBLE	
1632	1634	Blanco roto texturado RAL 9002 Textured off-white RAL 9002 Blanc cassé texturé RAL 9002	Metacrilato blanco opal Opal white methacrylate Méthacrylate opal blanc	PVC negro Black PVC PVC noir
1633	1635	Negro texturado RAL 9005 Textured black RAL 9005 Noir texturé RAL 9005	Metacrilato blanco opal Opal white methacrylate Méthacrylate opal blanc	PVC negro Black PVC PVC noir
1660	1662	Blanco roto texturado RAL 9002 Textured off-white RAL 9002 Blanc cassé texturé RAL 9002	Rafia Raffia Raphia	PVC negro Black PVC PVC noir
1661	1663	Negro texturado RAL 9005 Textured black RAL 9005 Noir texturé RAL 9005	Rafia Raffia Raphia	PVC negro Black PVC PVC noir
1664	1666	Blanco roto texturado RAL 9002 Textured off-white RAL 9002 Blanc cassé texturé RAL 9002	Cotonet sand Sand cotonet Cotonet sable	PVC negro Black PVC PVC noir
1665	1667	Negro texturado RAL 9005 Textured black RAL 9005 Noir texturé RAL 9005	Cotonet sand Sand cotonet Cotonet sable	PVC negro Black PVC PVC noir
1668	1670	Blanco roto texturado RAL 9002 Textured off-white RAL 9002 Blanc cassé texturé RAL 9002	Lamas de madera Wooden slats Lames de bois	PVC negro Black PVC PVC noir
1669	1671	Negro texturado RAL 9005 Textured black RAL 9005 Noir texturé RAL 9005	Lamas de madera Wooden slats Lames de bois	PVC negro Black PVC PVC noir
1708	1710	Blanco roto texturado RAL 9002 Textured off-white RAL 9002 Blanc cassé texturé RAL 9002	Pergamino blanco White parchment Parchemin blanc	PVC negro Black PVC PVC noir
1709	1711	Negro texturado RAL 9005 Textured black RAL 9005 Noir texturé RAL 9005	Pergamino blanco White parchment Parchemin blanc	PVC negro Black PVC PVC noir

Fanal s

Estructura en blanco o negro. Pantalla de metacrilato, rafia, cotonet o lamas de madera. Cable eléctrico de PVC negro.

White or black structure. Methacrylate, raffia, cottonet or wooden slats lampshade. Black electrical PVC cable.

Structure en blanc ou noir. Abat-jour en méthacrylate, raphia, cotonet ou lames de bois. Cable électrique PVC noir.



E-27 LED 12W



BIM/3D files: luxcambra.com/3D (3ds, dwg, 3dm, skp, rfa)

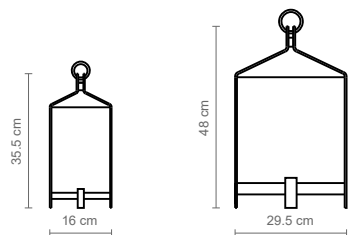

Fanal s S

Fanal s L

		ESTRUCTURA STRUCTURE STRUCTURE	PANTALLA LAMP SHADE ABAT-JOUR	CABLE CABLE CÂBLE
3257	3259	● Blanco roto texturado RAL 9002 Textured off-white RAL 9002 <i>Blanc cassé texturé RAL 9002</i>	■ Metacrilato blanco opal Opal white methacrylate <i>Méthacrylate opal blanc</i>	PVC negro Black PVC <i>PVC noir</i>
3258	3260	● Negro texturado RAL 9005 Textured black RAL 9005 <i>Noir texturé RAL 9005</i>	■ Metacrilato blanco opal Opal white methacrylate <i>Méthacrylate opal blanc</i>	PVC negro Black PVC <i>PVC noir</i>
3272	3274	● Blanco roto texturado RAL 9002 Textured off-white RAL 9002 <i>Blanc cassé texturé RAL 9002</i>	■ Rafia Raffia <i>Raphia</i>	PVC negro Black PVC <i>PVC noir</i>
3273	3275	● Negro texturado RAL 9005 Textured black RAL 9005 <i>Noir texturé RAL 9005</i>	■ Rafia Raffia <i>Raphia</i>	PVC negro Black PVC <i>PVC noir</i>
3276	3278	● Blanco roto texturado RAL 9002 Textured off-white RAL 9002 <i>Blanc cassé texturé RAL 9002</i>	■ Cotonet sand Sand cottonet <i>Cotonet sable</i>	PVC negro Black PVC <i>PVC noir</i>
3277	3279	● Negro texturado RAL 9005 Textured black RAL 9005 <i>Noir texturé RAL 9005</i>	■ Cotonet sand Sand cottonet <i>Cotonet sable</i>	PVC negro Black PVC <i>PVC noir</i>
3280	3282	● Blanco roto texturado RAL 9002 Textured off-white RAL 9002 <i>Blanc cassé texturé RAL 9002</i>	■ Lamas de madera Wooden slats <i>Lames de bois</i>	PVC negro Black PVC <i>PVC noir</i>
3281	3283	● Negro texturado RAL 9005 Textured black RAL 9005 <i>Noir texturé RAL 9005</i>	■ Lamas de madera Wooden slats <i>Lames de bois</i>	PVC negro Black PVC <i>PVC noir</i>
3314	3316	● Blanco roto texturado RAL 9002 Textured off-white RAL 9002 <i>Blanc cassé texturé RAL 9002</i>	■ Pergamino blanco White parchment <i>Parchemin blanc</i>	PVC negro Black PVC <i>PVC noir</i>
3315	3317	● Negro texturado RAL 9005 Textured black RAL 9005 <i>Noir texturé RAL 9005</i>	■ Pergamino blanco White parchment <i>Parchemin blanc</i>	PVC negro Black PVC <i>PVC noir</i>

Fanal s portátil

Estructura en blanco o negro. Pantalla de metacrilato, rafia, cotonet o lamas de madera. Sin conexión a red. Alimentación con fuente de luz led con batería recargable. 6h duración máxima potencia.

White or black structure. Methacrylate, raffia, cottonet or wooden slats lampshade. No connection to the network. Led light source power supply with rechargeable battery. 6h of battery life

Structure en blanc ou noir. Abat-jour en méthacrylate, raphia, cotonet ou lames de bois. Sans connexion au réseau. Source d'alimentation LED avec batterie rechargeable. 6h d'autonomie de batterie.



290 lm / 3.000K



BIM/3D files: luxcambra.com/3D (3ds, dwg, 3dm, skp, rfa)

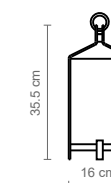

		ESTRUCTURA STRUCTURE STRUCTURE	PANTALLA LAMP SHADE ABAT-JOUR
3261		● Blanco roto texturado RAL 9002 Textured off-white RAL 9002 <i>Blanc cassé texturé RAL 9002</i>	■ Metacrilato blanco opal Opal white methacrylate <i>Méthacrylate opal blanc</i>
3262		● Negro texturado RAL 9005 Textured black RAL 9005 <i>Noir texturé RAL 9005</i>	■ Metacrilato blanco opal Opal white methacrylate <i>Méthacrylate opal blanc</i>
3284		● Blanco roto texturado RAL 9002 Textured off-white RAL 9002 <i>Blanc cassé texturé RAL 9002</i>	■ Rafia Raffia <i>Raphia</i>
3285		● Negro texturado RAL 9005 Textured black RAL 9005 <i>Noir texturé RAL 9005</i>	■ Rafia Raffia <i>Raphia</i>
3286		● Blanco roto texturado RAL 9002 Textured off-white RAL 9002 <i>Blanc cassé texturé RAL 9002</i>	■ Cotonet sand Sand cottonet <i>Cotonet sable</i>
3287		● Negro texturado RAL 9005 Textured black RAL 9005 <i>Noir texturé RAL 9005</i>	■ Cotonet sand Sand cottonet <i>Cotonet sable</i>
3288		● Blanco roto texturado RAL 9002 Textured off-white RAL 9002 <i>Blanc cassé texturé RAL 9002</i>	■ Lamas de madera Wooden slats <i>Lames de bois</i>
3289		● Negro texturado RAL 9005 Textured black RAL 9005 <i>Noir texturé RAL 9005</i>	■ Lamas de madera Wooden slats <i>Lames de bois</i>
3312		● Blanco roto texturado RAL 9002 Textured off-white RAL 9002 <i>Blanc cassé texturé RAL 9002</i>	■ Pergamino blanco White parchment <i>Parchemin blanc</i>
3313		● Negro texturado RAL 9005 Textured black RAL 9005 <i>Noir texturé RAL 9005</i>	■ Pergamino blanco White parchment <i>Parchemin blan</i>

Glos

Jordi Llopis

Los apliques Glos, a través de su pantalla esférica en cristal opal, aportan matices de luz para ser tamizada e iluminar adecuadamente cualquier espacio. Pretenden crear un ambiente armonioso y al mismo tiempo ser funcionales. Se incorpora un lector para maximizar la función de lámpara de cabecera.

Con la nueva versión Glos Slim se pretende potenciar la luz directa e indirecta de la pantalla de cristal que parece flotar sobre la placa estrecha metálica consiguiendo crear así un efecto más sugerente.

The Glos wall lamp, through its spherical opal glass shade, provides soft nuances of light and adequately illuminate any type of space. Its aim is to create a harmonious environment and be functional at the same time. A led reader is incorporated to maximize the bedside lamp function.

With this new Glos Slim version, the aim is to enhance the direct and indirect light from the glass shade that seems to float on the narrow metal plate, and thus creating a more suggestive effect.

L'applique murale Glos, grâce à son abat-jour sphérique en verre opale, offre de subtiles nuances de lumière et éclaire de manière adéquate tout type d'espace. Son objectif est de créer un environnement harmonieux et d'être fonctionnel en même temps. Un lecteur LED est incorporé pour maximiser la fonction de lampe de chevet.

Avec cette nouvelle version Glos Slim, l'objectif est de mettre en valeur la lumière directe et indirecte du globe en verre qui semble flotter sur la plaque étroite métallique, créant ainsi un aspect plus suggestif.

Familia / Family / Famille

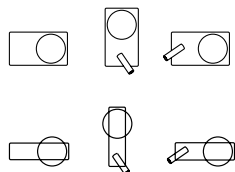



Glos

Estructura en blanco, negro o terracota. Pantalla de cristal opal blanco. Disponible con globo opal triplex.

White, black or terracotta structure. White opal glass lampshade. Available with triplex opal globe.

Structure en blanc, noir ou terracotta. Abat-jour en cristal opal blanc. Disponible avec globe opal triplex.



E-14 LED 12W



LED 3W
150 lm / 2.700K



BIM/3D files: luxcambra.com/3D (3ds, dwg, 3dm, skp, rfa)

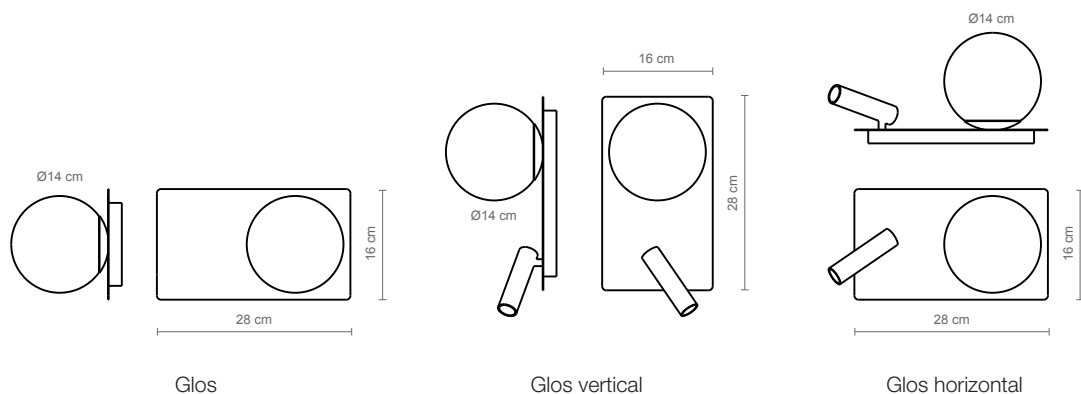

Glos slim

Estructura en blanco, negro o terracota. Pantalla de cristal opal blanco. Disponible con globo opal triplex.

White, black or terracotta structure. White opal glass lampshade. Available with triplex opal globe.

Structure en blanc, noir ou terracotta. Abat-jour en cristal opal blanc. Disponible avec globe opal triplex.



E-14 LED 12W



LED 3W
150 lm / 2.700K



BIM/3D files: luxcambra.com/3D (3ds, dwg, 3dm, skp, rfa)

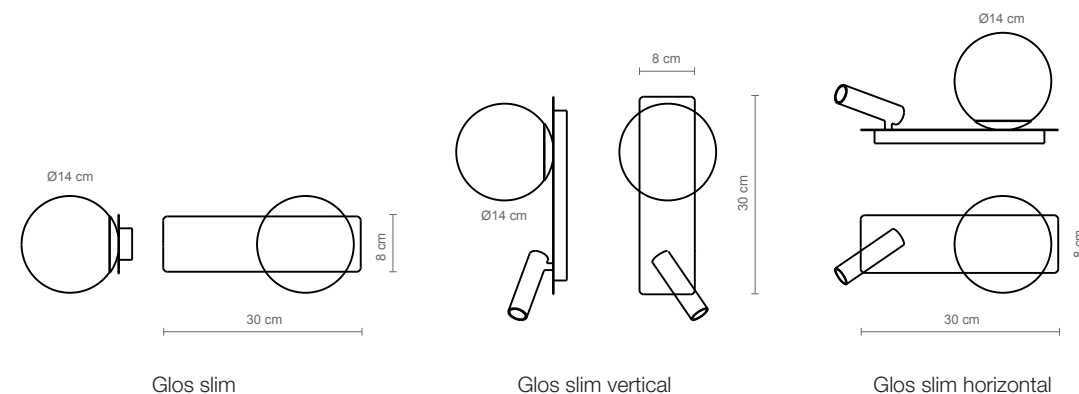

2671 2895 2668

ESTRUCTURA
STRUCTURE
STRUCTURE

● Blanco roto texturado RAL 9002
Off-white textured RAL 9002
Blanc cassé texturé RAL 9002

PANTALLA
LAMP SHADE
ABAT-JOUR

● Cristal opal blanco
White opal glass
Cristal opal blanc

2672 2896 2669

● Negro texturado RAL 9005
Textured black RAL 9005
Noir texturé RAL 9005

● Cristal opal blanco
White opal glass
Cristal opal blanc

2673 2897 2670

● Terracota RAL design 050-40-50
Terracotta RAL design 050-40-50
Terracotta RAL design 050-40-50

● Cristal opal blanco
White opal glass
Cristal opal blanc

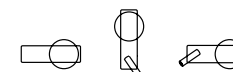

2677 2737 2674

ESTRUCTURA
STRUCTURE
STRUCTURE

● Blanco roto texturado RAL 9002
Off-white textured RAL 9002
Blanc cassé texturé RAL 9002

PANTALLA
LAMP SHADE
ABAT-JOUR

● Cristal opal blanco
White opal glass
Cristal opal blanc

2678 2738 2675

● Negro texturado RAL 9005
Textured black RAL 9005
Noir texturé RAL 9005

● Cristal opal blanco
White opal glass
Cristal opal blanc

2679 2739 2676

● Terracota RAL design 050-40-50
Terracotta RAL design 050-40-50
Terracotta RAL design 050-40-50

● Cristal opal blanco
White opal glass
Cristal opal blanc

H2

Joan Cambra 1986

Joan Cambra, fundador de la empresa en los años 60 y diseñador autodidacta, consiguió con su carácter carismático e inquieto crear un estilo propio en el mundo de la iluminación decorativa. La lámpara de sobremesa H2, producida en metal lacado en negro combinado con otros colores, fue un diseño icónico de los años 80 y ha sido reeditada este año con nuevos acabados.

Joan Cambra, founder of the company in the 1960s and a self-taught designer, managed to create his own style in the world of decorative lighting thanks to his charismatic and restless character. The H2 table lamp, produced in black lacquered metal combined with other colors was an iconic design of the 1980s and has been now reedited with new options of finishes.

Joan Cambra, fondateur de l'entreprise dans les années 1960 et designer autodidacte, a réussi à créer son propre style dans le monde de l'éclairage décoratif avec son caractère charismatique et curieux. La lampe de table H2, réalisée en métal laqué noir associé à d'autres couleurs, était un design iconique des années 1980 et a été réédité cette année avec de nouvelles finitions.



La reedición de la lámpara de sobremesa H2 es una manera de rendir homenaje al fundador de Luxcambra. Su diseño está cuidado al detalle y transmite la personalidad extrovertida y mediterránea de Joan Cambra.



Foto: Joan Cambra 1989

Sus lámparas eran sencillas, minimalistas, sin elementos superficiales y mantuvo esta línea coherente toda su vida. Era un creador nato sin ínfulas de diseñador. Una vez, en una entrevista dijo: “Para mí la satisfacción recae en el trabajo bien hecho, no en la fama. Me da exactamente igual que nadie sepa quién es Joan Cambra mientras mis lámparas gusten...”

The reedition of the H2 table lamp is a way of paying tribute to the founder of Luxcambra. Its design is meticulous for each detail and conveys the extroverted and Mediterranean personality of Joan Cambra.

His lamps were simple, minimalist, without superficial elements and he maintained this coherent line throughout his life. He was a born creator without the pretention of being a designer. He said once in an interview : “For me satisfaction lies in a job well done, not in fame. It does not really matter to me that nobody knows who Joan Cambra is as long as my lamps please people...”

La réédition de la lampe à poser H2 est une manière de rendre hommage au fondateur de Luxcambra. Son design est soigné dans les détails et transmet la personnalité extravertie et méditerranéenne de Joan Cambra.

Ses lampes étaient simples, minimalistes, sans éléments superficiels et il a maintenu cette ligne cohérente tout au long de sa vie. Il était un créateur né sans la prétention d'un designer. Un jour, dans une interview, il a déclaré : « Pour moi, la satisfaction réside dans le travail bien fait, et non dans la gloire. De toute manière, peu m'importe que personne ne sache qui est Joan Cambra tant que mes lampes plaisent... »





H2

Estructura en blanco, negro o terracota.

White, black or terracotta structure.

Structure en blanc, noir ou terracotta.



G9 LED 8W



BIM/3D files: luxcambra.com/3D (3ds, dwg, 3dm, skp, rfa)

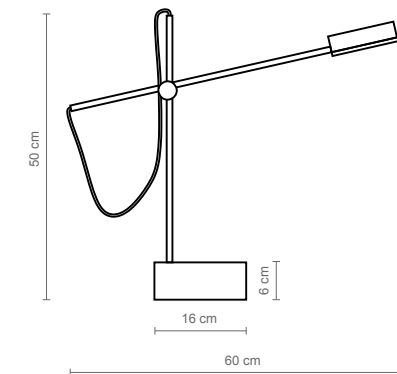

ESTRUCTURA
STRUCTURE
STRUCTURE

CABLE
CABLE
CÂBLE

3263 ● Blanco roto texturado RAL 9002
Off-white textured RAL 9002
Blanc cassé texturé RAL 9002

PVC negro
Black PVC
PVC noir

3264 ● Negro texturado RAL 9005
Textured black RAL 9005
Noir texturé RAL 9005

PVC negro
Black PVC
PVC noir

3265 ● Terracota RAL design 050-40-50
Terracotta RAL design 050-40-50
Terracotta RAL design 050-40-50

PVC negro
Black PVC
PVC noir

Indiana

Jordi Llopis

El diseño de la colección Indiana destaca por sus pantallas en organza. La transparencia de la tela se silencia con un difusor interno en forma de pantalla cónica. Las superposiciones dan volumen a la pantalla.

The uniqueness of the Indiana collection is due to its lampshade made of organza. As the transparency of the fabric is attenuated by the conical internal diffuser, the overlays add some interesting texture and volume.

Le design de la collection Indiana se distingue par son abat-jour en organza. La transparence du tissu est atténuée par un diffuseur interne de forme conique. Les superpositions donnent du volume à l'abat-jour.

Familia / Family / Famille

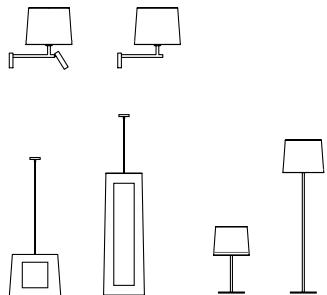











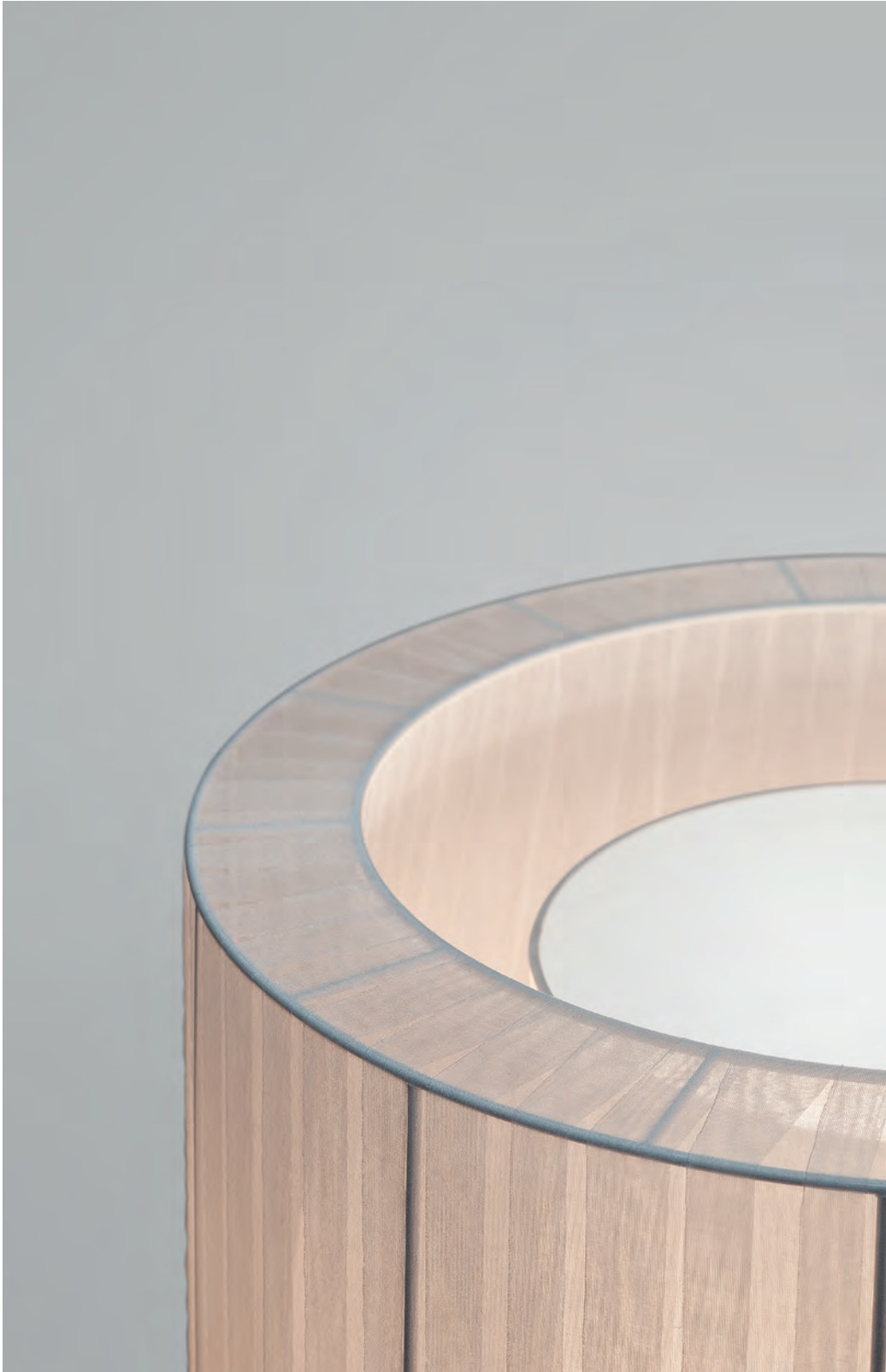



Indiana a

Estructura en blanco o negro. Pantalla doble en-
cintada de organza o en cotonet.

White or black structure. Double ribboned or coto-
net lampshade.

*Structure en blanc ou noir. Abat-jour double enrubanné
en organza ou cotonet.*



E-27 LED 12W



LED 3W
150 lm / 2.700K



BIM/3D files: luxcambra.com/3D (3ds, dwg, 3dm, skp, rfa)

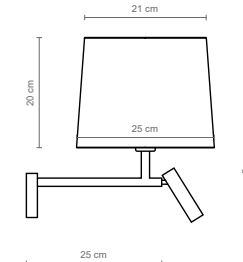

Indiana a lector

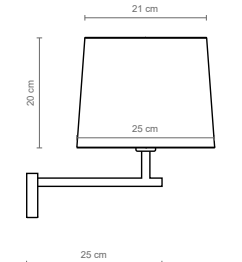

Indiana a

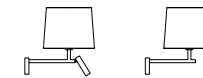

2052

2061

ESTRUCTURA
STRUCTURE
STRUCTURE

● Blanco RAL 9016
White RAL 9016
Blanc RAL 9016

PANTALLA
LAMP SHADE
ABAT-JOUR

■ Organza blanca
White organza
Organza blanche

2053

2062

● Blanco RAL 9016
White RAL 9016
Blanc RAL 9016

■ Organza gris
Grey organza
Organza grise

2054

2063

● Blanco RAL 9016
White RAL 9016
Blanc RAL 9016

■ Cotonet blanco
White cotonet
Cotonet blanc

2055

2064

● Negro RAL 9005
Black RAL 9005
Noir RAL 9005

■ Organza blanca
White organza
Organza blanche

2056

2065

● Negro RAL 9005
Black RAL 9005
Noir RAL 9005

■ Organza beige
Beige organza
Organza beige

2057

2066

● Negro RAL 9005
Black RAL 9005
Noir RAL 9005

■ Organza negra
Black organza
Organza noire

2058

2067

● Negro RAL 9005
Black RAL 9005
Noir RAL 9005

■ Organza gris
Grey organza
Organza grise

2059

2068

● Negro RAL 9005
Black RAL 9005
Noir RAL 9005

■ Arenal topo
Taupe arenal
Arenal taupe

2060

2069

● Negro RAL 9005
Black RAL 9005
Noir RAL 9005

■ Cotonet blanco
White cotonet
Cotonet blanc

Indiana c / Indiana c XL

Estructura en negro. Pantalla doble encintada de organza. Cable eléctrico de algodón negro.

Black structure. Double ribboned lampshade. Black electrical cotton cable.

Structure en noir. Abat-jour double enrubanné en organza ou cotonet. Câble électrique en coton noir.



E-27 LED 12W
(Indiana c)



2 x E-27 LED 12W
(Indiana c XL)



BIM/3D files: luxcambra.com/3D (3ds, dwg, 3dm, skp, rfa)

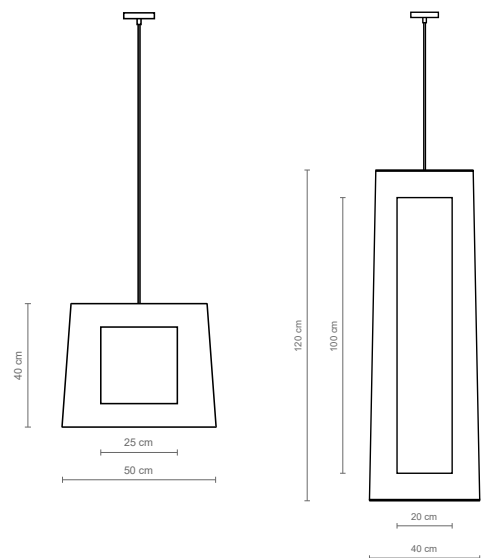

Indiana c

Indiana c XL

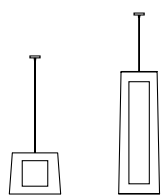

		ESTRUCTURA STRUCTURE STRUCTURE	PANTALLA LAMP SHADE ABAT-JOUR	CABLE CABLE CÂBLE
1040	1036	● Negro RAL 9005 Black RAL 9005 Noir RAL 9005	■ Organza blanca White organza Organza blanche	● Algodón negro Black cotton Coton noir
1041	1037	● Negro RAL 9005 Black RAL 9005 Noir RAL 9005	■ Organza beige Beige organza Organza beige	● Algodón negro Black cotton Coton noir
1042	1038	● Negro RAL 9005 Black RAL 9005 Noir RAL 9005	■ Organza negra Black organza Organza noire	● Algodón negro Black cotton Coton noir
1043	1039	● Negro RAL 9005 Black RAL 9005 Noir RAL 9005	■ Organza gris Grey organza Organza grise	● Algodón negro Black cotton Coton noir

Indiana s / Indiana p

Estructura en blanco o negro. Pantalla doble encintada de organza. Cable eléctrico de PVC negro o transparente.

Black or white structure. Double ribboned lampshade. Black electrical PVC or transparent cable.

Structure en noir ou blanc. Abat-jour double enrubanné en organza ou cotonet. Câble électrique PVC noir ou transparent.



E-27 LED 12W



BIM/3D files: luxcambra.com/3D (3ds, dwg, 3dm, skp, rfa)

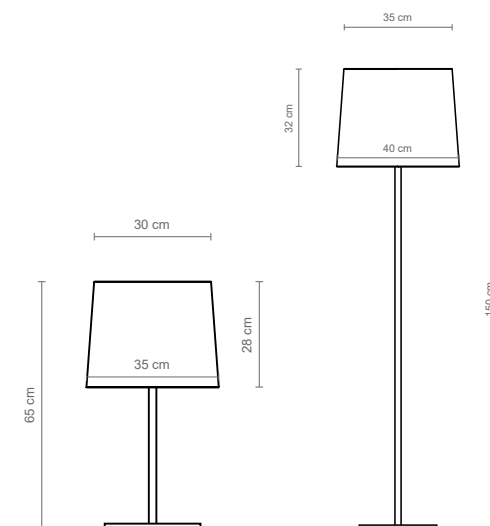

Indiana s

Indiana p

		ESTRUCTURA STRUCTURE STRUCTURE	PANTALLA LAMP SHADE ABAT-JOUR	CABLE CABLE CÂBLE
3050	4084	● Blanco RAL 9016 White RAL 9016 Blanc RAL 9016	■ Organza blanca White organza Organza blanche	● Transparente Transparent Transparent
3051	4085	● Blanco RAL 9016 White RAL 9016 Blanc RAL 9016	■ Organza gris Grey organza Organza grise	● Transparente Transparent Transparent
3052	4086	● Negro RAL 9005 Black RAL 9005 Noir RAL 9005	■ Organza blanca White organza Organza blanche	● PVC negro Black PVC PVC noir
3053	4087	● Negro RAL 9005 Black RAL 9005 Noir RAL 9005	■ Organza beige Beige organza Organza beige	● PVC negro Black PVC PVC noir
3054	4088	● Negro RAL 9005 Black RAL 9005 Noir RAL 9005	■ Organza negra Black organza Organza noire	● PVC negro Black PVC PVC noir
3055	4089	● Negro RAL 9005 Black RAL 9005 Noir RAL 9005	■ Organza gris Grey organza Organza grise	● PVC negro Black PVC PVC noir

Jana

Luxcambra Team

El diseño minimalista de la lámpara Jana, con sus originales tres pies largos y delgados y su pantalla cilíndrica, crea atmósferas llenas de personalidad. La luz de sus pantallas humaniza cualquier espacio.

The minimalist design of the Jana lamp, with its original three long and slim feet and its cylindrical lampshade, creates atmospheres full of personality. The light of its shades humanizes any kind of environment.

Le design minimaliste de la lampe Jana, avec ses trois pieds longs et fins originaux et son abat-jour cylindrique, crée des atmosphères pleines de personnalité. La lumière des abat-jours humanise tout type d'espace.





Jana

Estructura en blanco o negro. Pantalla de cotonet, osaka o loneta. Cable eléctrico de PVC negro.

Black or white structure. Cotonet, osaka or cotton-lampshade. Black electrical PVC cable.

Structure en noir ou blanc. Abat-jour en cotonet, osaka ou coton. Câble électrique PVC noir.



E-27 LED 12W



BIM/3D files: luxcambra.com/3D (3ds, dwg, 3dm, skp, rfa)

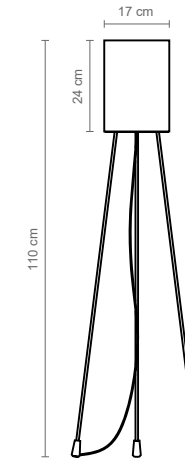

	ESTRUCTURA STRUCTURE STRUCTURE	PANTALLA LAMP SHADE ABAT-JOUR	CABLE CABLE CÂBLE
4024	● Blanco mate texturado RAL 9016 Textured matt white RAL 9016 <i>Blanc texturé mat RAL 9016</i>	■ Cotonet blanco White cotonet <i>Cotonet blanc</i>	● PVC negro Black PVC <i>PVC noir</i>
4025	● Blanco mate texturado RAL 9016 Textured matt white RAL 9016 <i>Blanc texturé mat RAL 9016</i>	■ Arenal topo Taupe arenal <i>Arenal taupe</i>	● PVC negro Black PVC <i>PVC noir</i>
4026	● Negro texturado RAL 9005 Textured black RAL 9005 <i>Noir texturé RAL 9005</i>	■ Cotonet blanco White cotonet <i>Cotonet blanc</i>	● PVC negro Black PVC <i>PVC noir</i>
4027	● Negro texturado RAL 9005 Textured black RAL 9005 <i>Noir texturé RAL 9005</i>	■ Osaka Osaka <i>Osaka</i>	● PVC negro Black PVC <i>PVC noir</i>
4028	● Negro texturado RAL 9005 Textured black RAL 9005 <i>Noir texturé RAL 9005</i>	■ Loneta natural Natural cotton <i>Coton naturel</i>	● PVC negro Black PVC <i>PVC noir</i>

Kan

Jordi Llopis

Inspirada en los juegos de encajes entre módulos, la colección Kan quiere crear un efecto de luces entre piezas que se iluminen mutuamente y que permitan matizar la luz para crear espacios amables y cálidos. Un juego entre texturas, frías en la parte metálica y cálidas en la parte téxtil. Cada pantalla téxtil es intercambiable y sus múltiples combinaciones la convierten en una colección versátil y que ofrece soluciones para espacios y ambientes diversos. Kan funciona sola y también a partir de repeticiones.

Inspired by puzzles and assembly kits, the Kan collection aims at creating light effects between its different components. The shades light up simultaneously and soften the light source to create a warm and cosy atmosphere. The balance between metal and textile reveals a play of textures and colour nuances. Each textile shade is interchangeable allowing plenty of combinations. This functionality makes it easy to combine the lamps, by disposing them in lineal, circular or cascading series.

Inspirée des jeux d'assemblage de pièces, la collection Kan vise à créer un effet de lumière entre les différentes pièces qui s'illuminent simultanément et qui permettent d'adoucir la lumière pour créer des espaces agréables et chaleureux. Cette collection représente un jeu entre textures froides par l'aspect métallique et textures chaudes par l'abat-jour textile. Chaque abat-jour textile est interchangeable et ses multiples combinaisons permettent de créer des ensembles de séries linéaires, circulaires ou en cascade.

Familia / Family / Famille

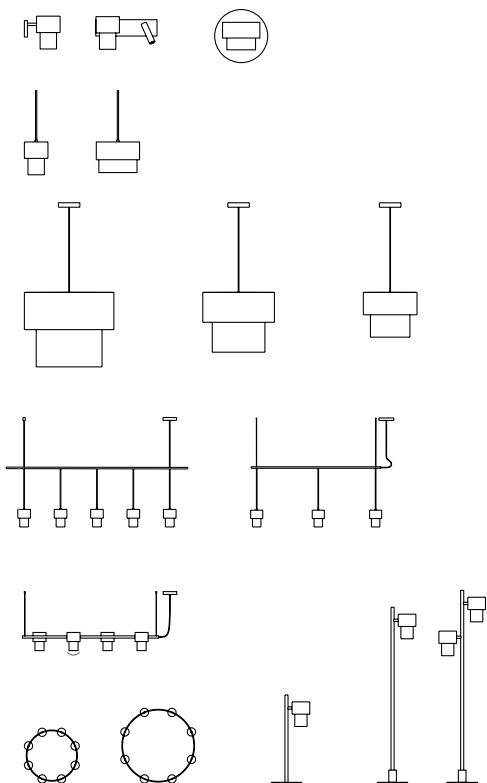



Kan Chandelier hace crecer la colección Kan para explorar e ir más allá de una simple pieza decorativa y poder crear un sistema modular para espacios arquitectónicos permitiendo crear formatos que se adapten a cualquier proyecto.

Kan Chandelier is a new extension of the Kan collection which goes beyond a simple decorative piece as it creates a modular system for architectural spaces, allowing the creation of different formats adapted to any type of project.

Kan Chandelier fait grandir la collection Kan pour explorer et aller au-delà d'une simple pièce décorative en créant un système modulaire pour les espaces architecturaux, ce qui permet la création de formats adaptés à tout type de projet.

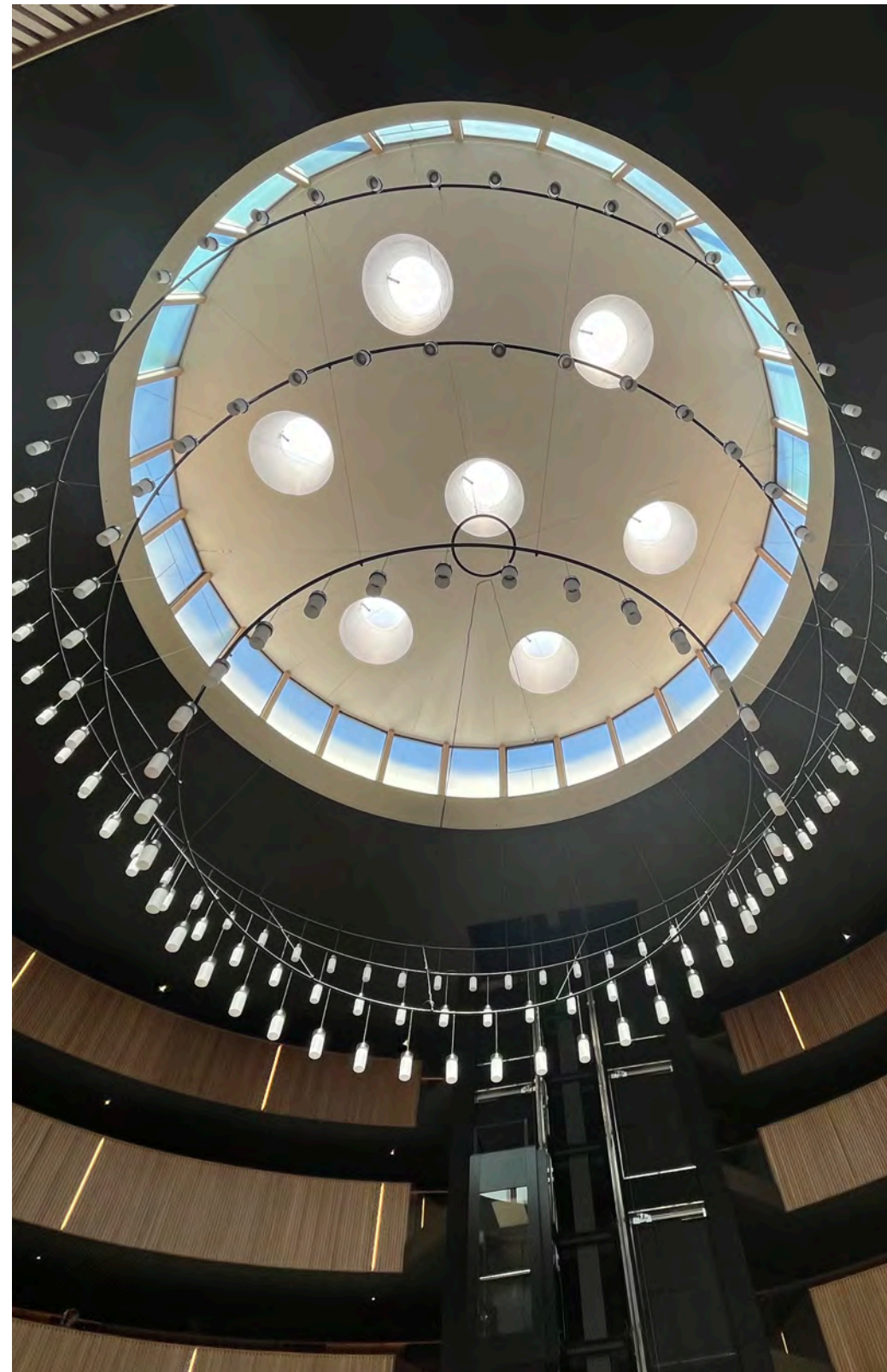









Esta versión tiene como función principal orientar cada pantalla individualmente, con varios acabados disponibles que permiten crear distintos ambientes jugando con la luz y dirigirla de modo fácil en la misma lámpara, ya sea en espacios abiertos comunes o como lámpara específica encima de una mesa.

This version has a main function of adjusting individually each lampshade, as well as combining different shade finishes. It creates unique environments as you can play with the light by directing it easily, either in public open spaces or above a table.

La fonction principale de cette nouvelle version Kan articulée est d'orienter chaque abat-jour individuellement, avec différentes finitions disponibles qui permettent de créer des environnements en jouant avec la lumière et en la dirigeant facilement sur une même lampe, soit dans des espaces ouverts communs, soit comme lampe centrale au dessus d'une table.





Esta versión un poco más grande de la lámpara de suspensión Kan permite llenar espacios más amplios, y combinar los distintos acabados de pantalla para que tengan más protagonismo.

This new large version allows you to fill in larger spaces, as well as expanding the finishes combinations so that it has more prominence.

Cette nouvelle version vous permet de remplir des espaces plus grands et de combiner les différentes finitions afin qu'elles aient plus d'importance.







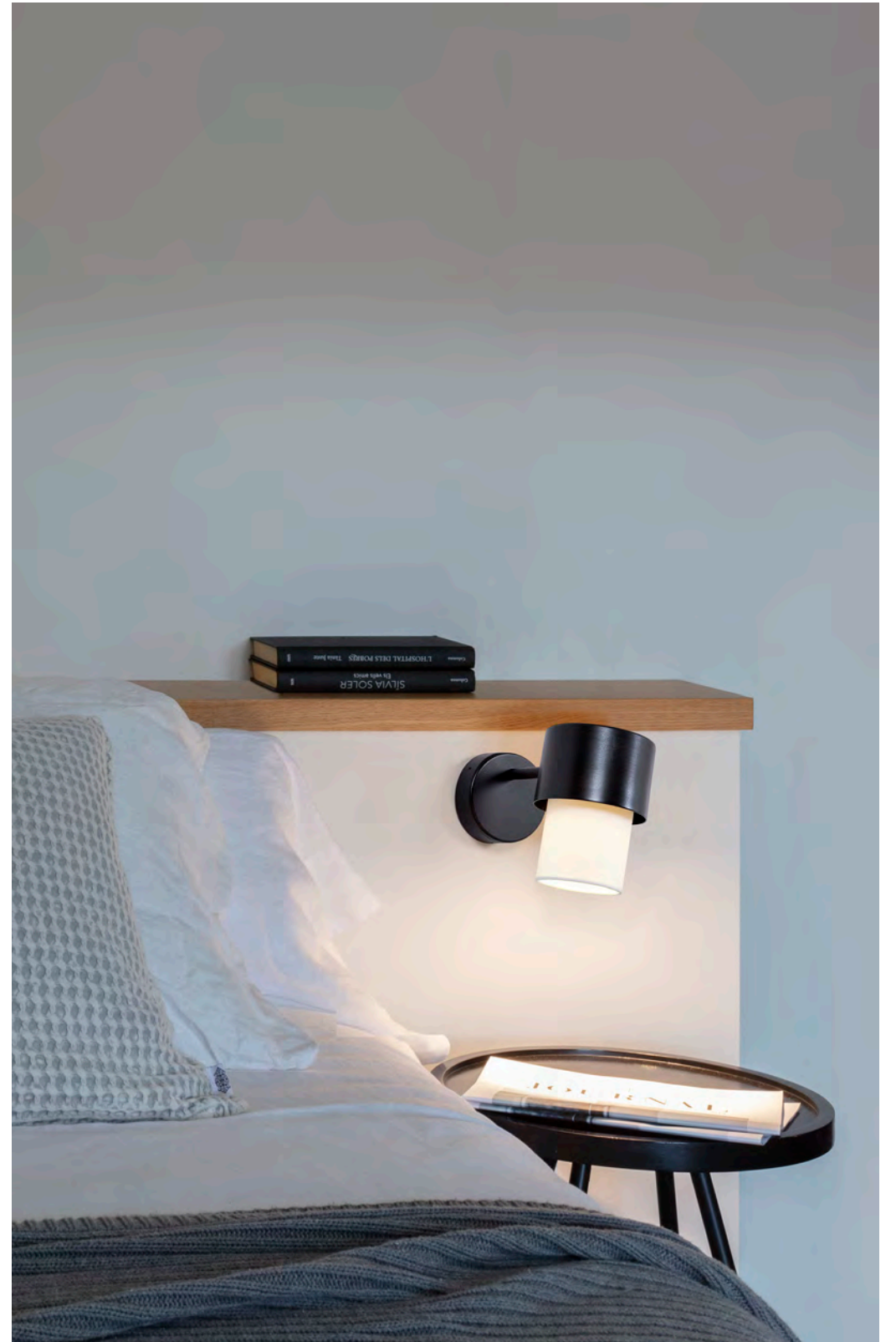
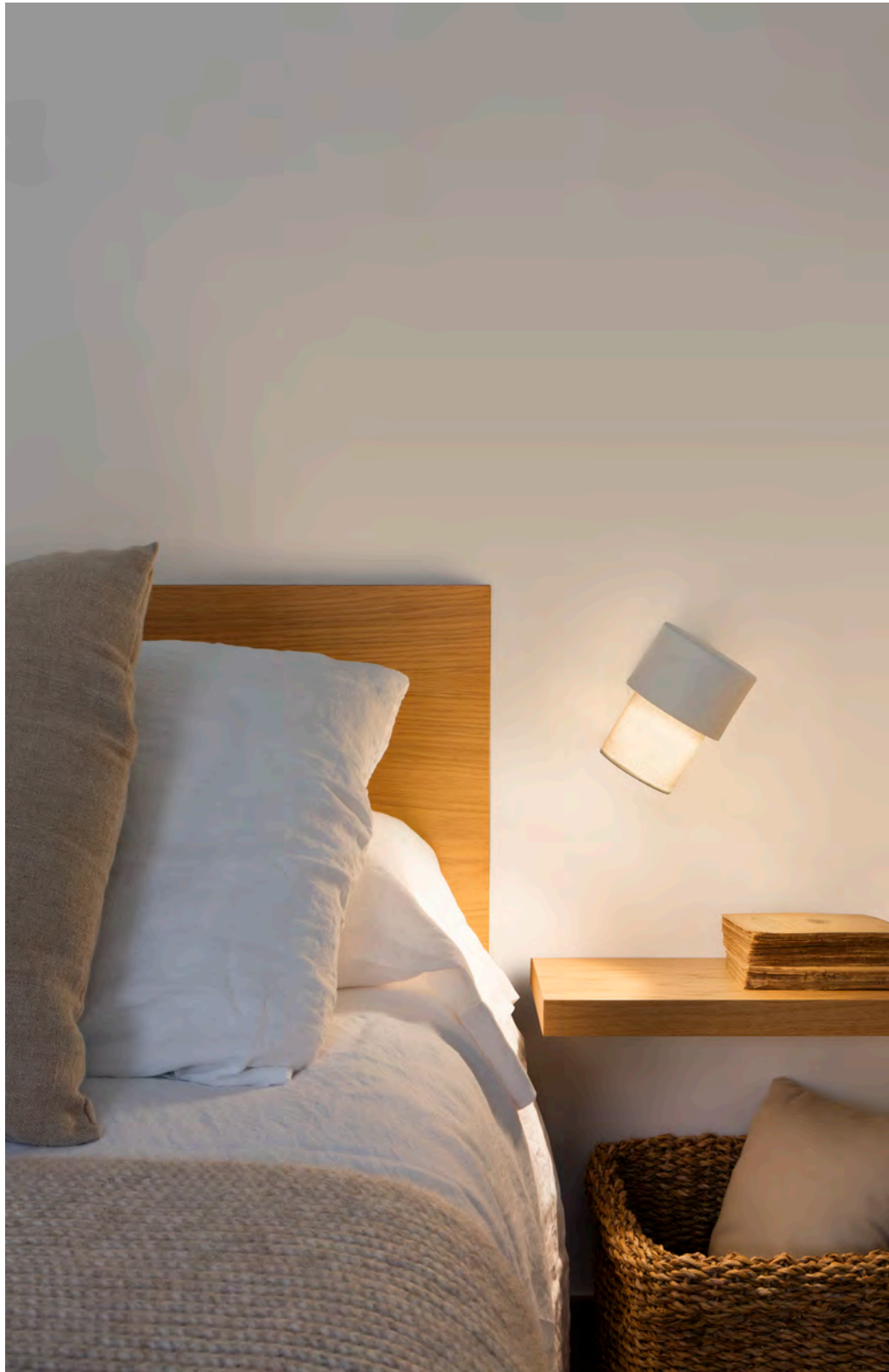



Esta nueva versión de aplique Kan se complementa con una base rectangular horizontal y un lector para explorar toda la función de una lámpara de cabecera, para habitaciones de hoteles y también entornos privados.

This new wall lamp version Kan is complemented by a horizontal rectangular base and a reader to fully explore the bedside lamp function, either for hotel rooms or private spaces.

Cette nouvelle version de l'applique murale Kan est complétée par une base rectangulaire horizontale et un lecteur pour explorer la pleine fonction d'une lampe de chevet, pour les chambres d'hôtel et également les environnements privés.





Este nuevo aplique KAN ilustra nuestro compromiso con la producción local sostenible, donde todas las piezas son ajustables para diferentes versiones y con materiales ecológicos. Su función principal orientable, permite crear distintos ambientes jugando con la luz y dirigiéndola de modo fácil, ya sea en espacios abiertos comunes o como lámpara de cabecera.

This new KAN wall lamp illustrates our commitment to sustainable local production, where all the parts are reusable and adjustable for different versions and with eco-friendly materials. Its main adjustable function allows you to create different environments by playing with light effects and directing it easily, either in common open spaces or as a bedside lamp.

Cette nouvelle applique murale KAN illustre notre engagement pour une production locale durable, où toutes les pièces sont réutilisables et ajustables pour différentes versions et avec des matériaux respectueux de l'environnement. Sa fonction principale orientable vous permet de créer différents environnements en jouant avec les effets de lumière et en l'orientant facilement, soit dans des espaces communs ouverts, soit comme lampe de chevet.

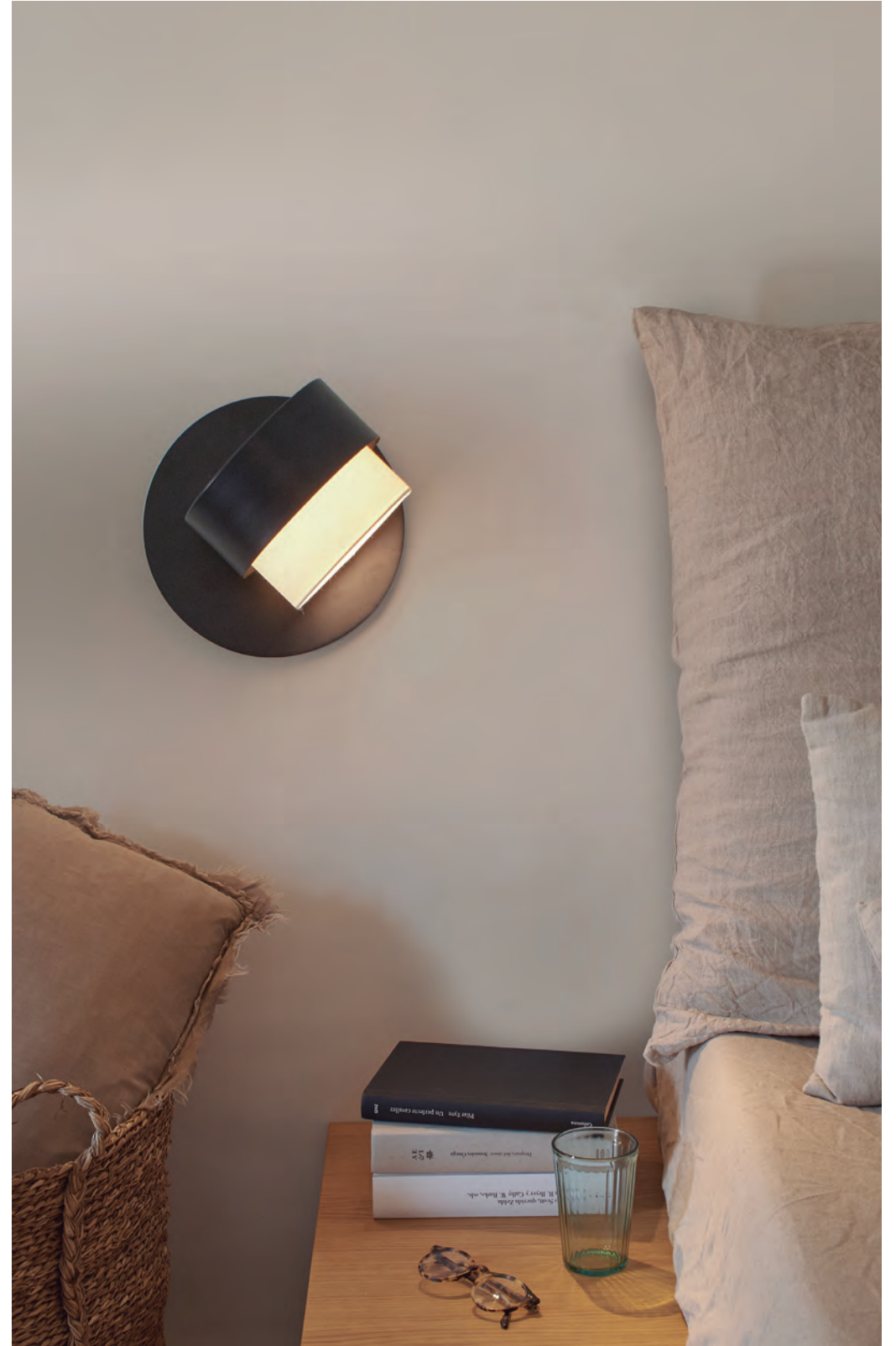
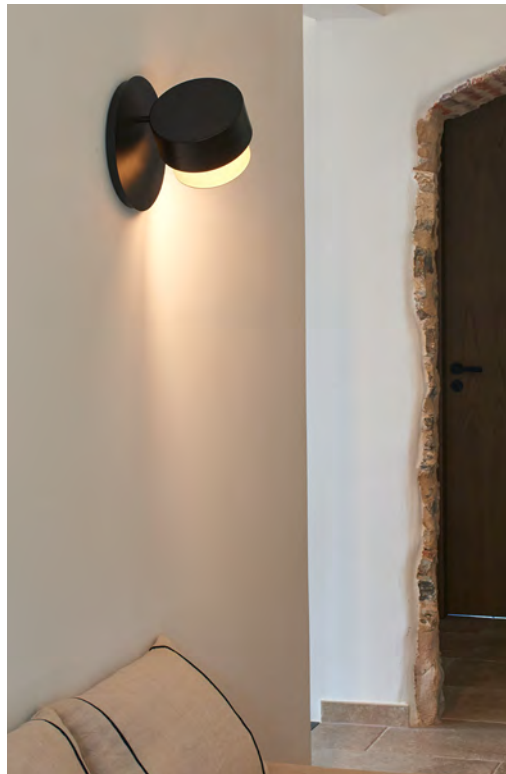
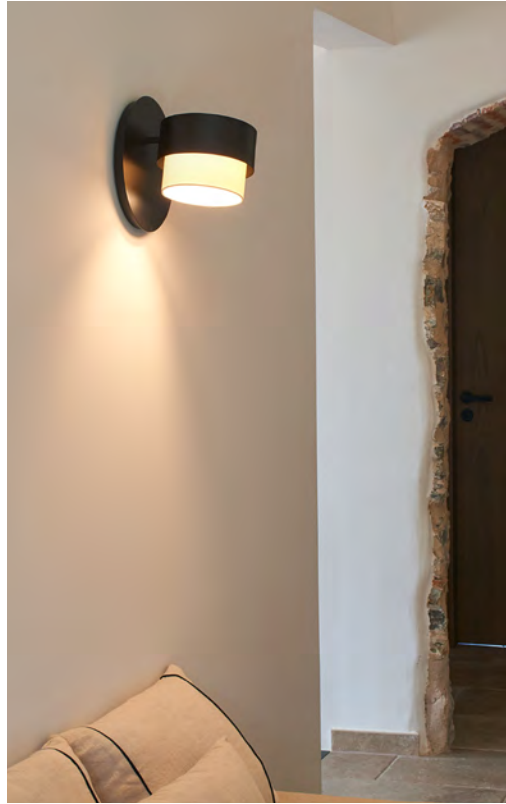







Kan a / Kan a lector

Estructura en blanco, negro o terracota. Pantalla de cotonet.

White, black or terracotta structure. Cotonet lampshade.

Structure en blanc, noir ou terracotta. Abat-jour en cotonet.



GU-10 LED 8W



LED 3W

150 lm / 2.700K



BIM/3D files: luxcambra.com/3D (3ds, dwg, 3dm, skp, rfa)

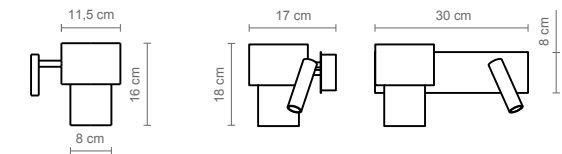

Kan a

Kan a lector



			ESTRUCTURA STRUCTURE	PANTALLA LAMP SHADE ABAT-JOUR
2375	2695	2742	● Blanco roto texturado RAL 9002 Off-white textured RAL 9002 <i>Blanc cassé texturé RAL 9002</i>	■ Cotonet gris frío Cold grey cotonet <i>Cotonet gris froid</i>
2572			● Blanco roto texturado RAL 9002 Off-white textured RAL 9002 <i>Blanc cassé texturé RAL 9002</i>	■ Cotonet arena oscura Dark sand cotonet <i>Cotonet sable sombre</i>
2377	2694	2741	● Blanco roto texturado RAL 9002 Off-white textured RAL 9002 <i>Blanc cassé texturé RAL 9002</i>	■ Cotonet sand Sand cotonet <i>Cotonet sable</i>
2378	2693	2740	● Blanco roto texturado RAL 9002 Off-white textured RAL 9002 <i>Blanc cassé texturé RAL 9002</i>	■ Cotonet blanco White cotonet <i>Cotonet blanc</i>
2379	2698	2745	● Negro texturado RAL 9005 Textured black RAL 9005 <i>Noir texturé RAL 9005</i>	■ Cotonet gris frío Cold grey cotonet <i>Cotonet gris froid</i>
2573			● Negro texturado RAL 9005 Textured black RAL 9005 <i>Noir texturé RAL 9005</i>	■ Cotonet arena oscura Dark sand cotonet <i>Cotonet sable sombre</i>
2381	2697	2744	● Negro texturado RAL 9005 Textured black RAL 9005 <i>Noir texturé RAL 9005</i>	■ Cotonet sand Sand cotonet <i>Cotonet sable</i>
2382	2696	2743	● Negro texturado RAL 9005 Textured black RAL 9005 <i>Noir texturé RAL 9005</i>	■ Cotonet blanco White cotonet <i>Cotonet blanc</i>
	2699	2746	● Terracota RAL design 050-40-50 Terracotta RAL design 050-40-50 <i>Terracotta RAL design 050-40-50</i>	■ Cotonet blanco White cotonet <i>Cotonet blanc</i>
	2700	2747	● Terracota RAL design 050-40-50 Terracotta RAL design 050-40-50 <i>Terracotta RAL design 050-40-50</i>	■ Cotonet sand Sand cotonet <i>Cotonet sable</i>

Kan a XL

Estructura en blanco, negro, terracota o dorado satinado. Pantalla de cotonet o rafia.

White, black, terracotta or satin gold structure. Cotonet or raffia lampshade.

Structure en blanc, noir, terracotta ou doré satiné. Abat-jour en cotonet ou raphia.



GX-53 LED 8W
670 lm / 2.700 K



BIM/3D files: luxcambra.com/3D (3ds, dwg, 3dm, skp, rfa)

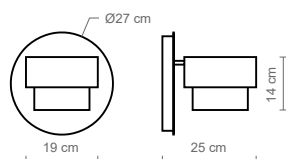

	ESTRUCTURA STRUCTURE STRUCTURE	PANTALLA LAMP SHADE ABAT-JOUR
2680	Blanco roto texturado RAL 9002 Off-white textured RAL 9002 Blanc cassé texturé RAL 9002	Cotonet blanco White cotonet Cotonet blanco
2681	Blanco roto texturado RAL 9002 Off-white textured RAL 9002 Blanc cassé texturé RAL 9002	Cotonet sand Cotonet Sand Cotonet sable
2682	Blanco roto texturado RAL 9002 Off-white textured RAL 9002 Blanc cassé texturé RAL 9002	Cotonet gris frío Cold grey cotonet Cotonet gris froid
2683	Blanco roto texturado RAL 9002 Textured off-white RAL 9002 Blanc cassé texturé RAL 9002	Rafia Raffia Raphia
2684	Negro texturado RAL 9005 Textured black RAL 9005 Noir texturé RAL 9005	Cotonet blanco White cotonet Cotonet blanco
2685	Negro texturado RAL 9005 Textured black RAL 9005 Noir texturé RAL 9005	Cotonet sand Sand cotonet Cotonet sable
2686	Negro texturado RAL 9005 Textured black RAL 9005 Noir texturé RAL 9005	Cotonet gris frío Cold grey cotonet Cotonet gris froid
2687	Negro texturado RAL 9005 Textured black RAL 9005 Noir texturé RAL 9005	Rafia Raffia Raphia
2688	Terracota RAL design 050-40-50 Terracotta RAL design 050-40-50	Cotonet blanco White cotonet Cotonet blanc
2689	Terracota RAL design 050-40-50 Terracotta RAL design 050-40-50	Cotonet sand Sand cotonet Cotonet sable
2690	Dorado satinado Satin gold Doré satiné	Cotonet blanco White cotonet Cotonet blanc
2691	Dorado satinado Satin gold Doré satiné	Cotonet sand Sand cotonet Cotonet sable
2692	Dorado satinado Satin gold Doré satiné	Rafia Raffia Raphia

Kan c XS / Kan c S

Estructura en blanco, negro, terracota o dorado satinado. Pantalla de cotonet o rafia. Cable de algodón negro.

White, black, terracotta or satin gold structure. Cotonet or raffia lampshade. Black cotton cable.

Structure en blanc, noir, terracotta ou doré satiné. Abat-jour en cotonet ou raphia. Câble coton noir.



GU-10 LED 8W
(Kan c XS)



GX-53 LED 8W
670 lm / 2.700 K
(Kan c S)



BIM/3D files: luxcambra.com/3D (3ds, dwg, 3dm, skp, rfa)

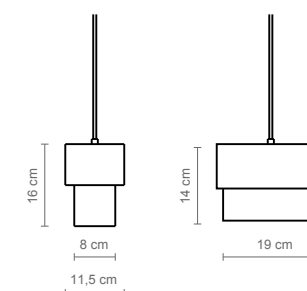

Kan c XS

Kan c S

		ESTRUCTURA Y FLORÓN STRUCTURE AND CEILING SUPPORT STRUCTURE ET SUPPORT PLAFOND	PANTALLA LAMP SHADE ABAT-JOUR
1341	1644	Blanco RAL 9002 White 9002 Blanc 9002	Cotonet blanco White cotonet Cotonet blanc
1340	1645	Blanco RAL 9002 White 9002 Blanc 9002	Cotonet sand Sand cotonet Cotonet sable
1338	1646	Blanco RAL 9002 White 9002 Blanc 9002	Cot. gris frío Cold grey cot. Cot. gris froid
	1647	Blanco RAL 9002 White 9002 Blanc 9002	Rafia Raffia Raphia
1436		Blanco RAL 9002 White 9002 Blanc 9002	Cot. arena osc. Dark sand sable foncé
1345	1648	Negro RAL 9005 Black 9005 Noir 9005	Cotonet blanco White cotonet Cotonet blanc
1344	1649	Negro RAL 9005 Black 9005 Noir 9005	Cotonet sand Sand cotonet Cotonet sable
1342	1650	Negro RAL 9005 Black 9005 Noir 9005	Cot. gris frío Cold grey cot. Cot. gris froid
	1651	Negro RAL 9005 Black 9005 Noir 9005	Rafia Raffia Raphia
1437		Negro RAL 9005 Black 9005 Noir 9005	Cot. arena osc. Dark sand sable foncé
	1652	Terracota RAL design 050-40-50 Terracotta	Cotonet blanco White cotonet Cotonet blanc
	1653	Terracota RAL design 050-40-50 Terracotta	Cotonet sand Sand cotonet Cotonet sable
	1654	Dorado satinado Satin gold Doré satiné	Cotonet blanco White cotonet Cotonet blanc
	1655	Dorado satinado Satin gold Doré satiné	Cotonet sand Sand cotonet Cotonet sable
	1656	Dorado satinado Satin gold Doré satiné	Rafia Raffia Raphia

Kan c doble

Estructura en blanco o negro. Pantalla de cotonet, lino o rafia. Medidas especiales para proyectos contract (consultar). Cable eléctrico de algodón negro.

White or black structure. Cotonet, linen or raffia lampshade. Special sizes for contract projects (to consult). Black electrical cotton cable.

Structure en blanc ou noir. Abat-jour en cotonet, lin ou raphia. Mesures spéciales pour les projets contract (à consulter). Câble électrique de coton noir.



E-27 LED 12W



BIM/3D files: luxcambra.com/3D (3ds, dwg, 3dm, skp, rfa)

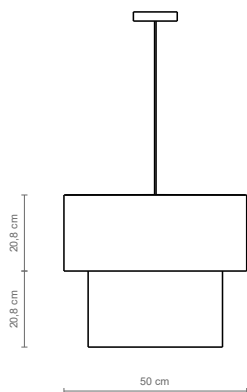

Kan c doble XL

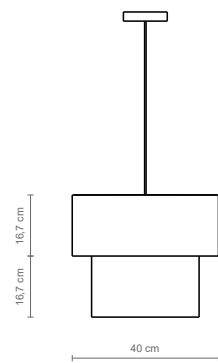

Kan c doble L

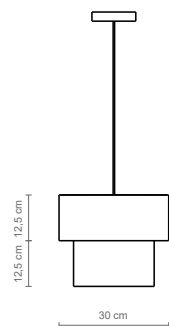

Kan c doble M

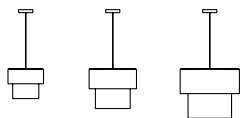

FLORÓN
CEILING SUPPORT
SUPPORT PLAFOND

PANTALLA
LAMP SHADE
ABAT-JOUR

1462	1471	1480	● RAL 9005	■ Cotonet negro + Cotonet gris frío Black + Cold gray cotonet Cotonet noir + Cotonet gris froid
1463	1472	1481	● RAL 9005	■ Cotonet negro + Cot. arena oscura Black + Dark sand cot. Cotonet noir + Cotonet sable sombre
1464	1473	1482	● RAL 9005	■ Cotonet negro + Cotonet sand Black + Sand cotonet Cotonet noir + Cotonet sand
1465	1474	1483	● RAL 9005	■ Cotonet negro + Cotonet blanco Black + White cotonet Cotonet noir + Cotonet blanc
1466	1475	1484	● RAL 9005	■ Cotonet negro + Lino Black cotonet + Linen Cotonet noir + Lin
1467	1476	1485	● RAL 9005	■ Cotonet negro + Rafia Black cotonet + Raffia Cotonet noir + Raphia
1468	1477	1486	● RAL 9002	■ Cotonet sand + Cotonet sand Sand cotonet + Sand cotonet Cotonet sand + Cotonet sand
1469	1478	1487	● RAL 9002	■ Cotonet sand + Lino Sand cotonet + Linen Cotonet sand + Lin
1470	1479	1488	● RAL 9002	■ Cotonet sand + Rafia Sand cotonet + Raffia Cotonet sand + Raphia

Kan c lineal

Estructura en blanco, negro o terracota. Pantalla de cotonet. Cable eléctrico de algodón negro.

White, black or terracotta structure. Cotonet lampshade. Black electrical cotton cable.

Structure en blanc, noir ou terracotta. Abat-jour en cotonet. Câble électrique de coton noir.



3 x GU-10 LED 8W
(Kan c lineal 3)



4 x GU-10 LED 8W
(Kan c lineal 4)
articulado



5 x GU-10 LED 8W
(Kan c lineal 5)



BIM/3D files: luxcambra.com/3D (3ds, dwg, 3dm, skp, rfa)

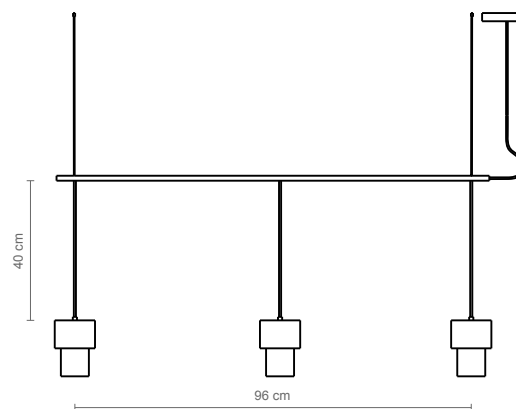

Kan c lineal 3

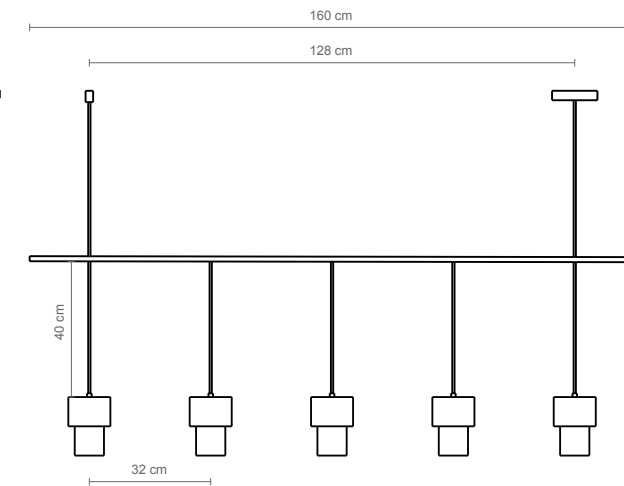

Kan c lineal 5

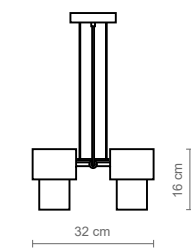

Kan c lineal 4

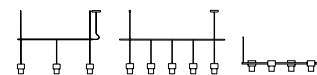

ESTRUCTURA
STRUCTURE
STRUCTURE

PANTALLA
LAMP SHADE
ABAT-JOUR

1438	1516	1638	● RAL 9002	■ Cotonet gris frío Cold gray cotonet Cotonet gris froid
1439	1517		● RAL 9002	■ Cot. arena oscura Dark sand cotonet Cotonet sable sombre
1440	1518	1637	● RAL 9002	■ Cotonet sand Sand cotonet Cotonet sand
1441	1519	1636	● RAL 9002	■ Cotonet blanco White cotonet Cotonet blanc
1442	1520	1641	● RAL 9005	■ Cotonet gris frío Cold gray cotonet Cotonet gris froid
1443	1521		● RAL 9005	■ Cot. arena oscura Dark sand cotonet Cotonet sable sombre
1444	1522	1640	● RAL 9005	■ Cotonet sand Sand cotonet Cotonet sand
1445	1523	1639	● RAL 9005	■ Cotonet blanco White cotonet Cotonet blanc
		1642	● Terracota	■ Cotonet blanco White cotonet Cotonet blanc
		1643	● Terracota	■ Cotonet sand Sand cotonet Cotonet sand

Kan c chandelier

Estructura en blanco o negro. Pantalla de cotonet.
Cable eléctrico de PVC negro.

White or black structure. Cotonet lampshade.
Black electrical PVC cable.

Structure en blanc ou noir. Abat-jour en cotonet. Câble électrique de PVC noir.



8 x GU-10 LED 8W



BIM/3D files: luxcambra.com/3D (3ds, dwg, 3dm, skp, rfa)

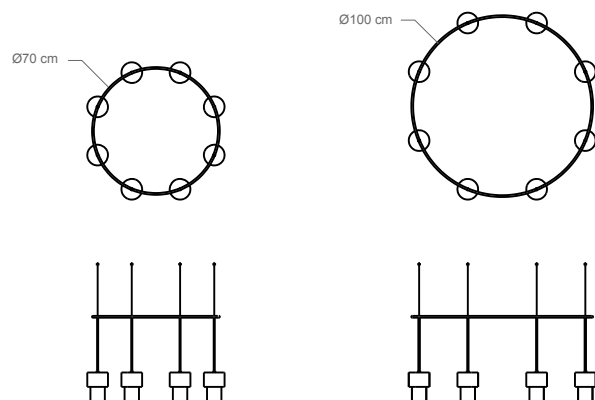

Kan chandelier 70

Kan chandelier 100

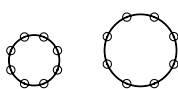

		ESTRUCTURA STRUCTURE STRUCTURE	PANTALLA LAMP SHADE ABAT-JOUR
1446	1454	RAL 9002	Cotonet gris frío Cold gray cotonet Cotonet gris froid
1447	1455	RAL 9002	Cot. arena oscura Dark sand cotonet Cotonet sable sombre
1448	1456	RAL 9002	Cotonet sand Sand cotonet Cotonet sand
1449	1457	RAL 9002	Cotonet blanco White cotonet Cotonet blanc
1450	1458	RAL 9005	Cotonet gris frío Cold gray cotonet Cotonet gris froid
1451	1459	RAL 9005	Cot. arena oscura Dark sand cotonet Cotonet sable sombre
1452	1460	RAL 9005	Cotonet sand Sand cotonet Cotonet sand
1453	1461	RAL 9005	Cotonet blanco White cotonet Cotonet blanc

Kan s / Kan p

Estructura en blanco o negro. Pantalla de cotonet.
Cable eléctrico de PVC negro o transparente.

White or black structure. Cotonet lampshade.
Black or transparent electrical PVC cable.

Structure en blanc ou noir. Abat-jour en cotonet. Câble électrique de PVC noir ou transparent.



GU-10 LED 8W



BIM/3D files: luxcambra.com/3D (3ds, dwg, 3dm, skp, rfa)

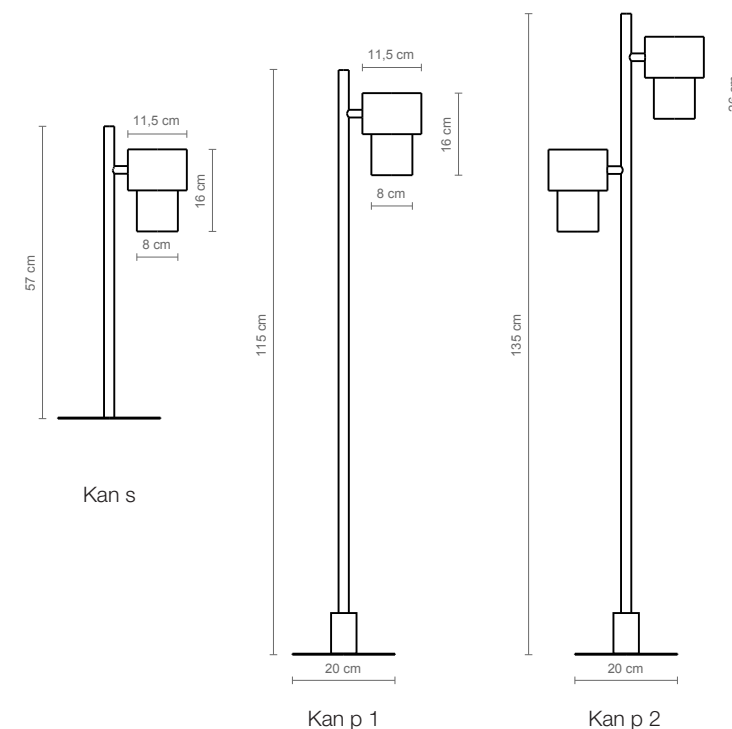

Kan s

Kan p 1

Kan p 2

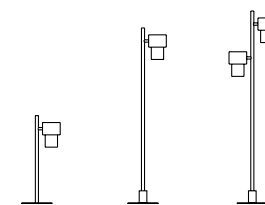

			ESTRUCTURA STRUCTURE STRUCTURE	PANTALLA LAMP SHADE ABAT-JOUR
3142	4156	4164	RAL 9002	Cotonet gris frío Cold gray cotonet Cotonet gris froid
3166	4215	4217	RAL 9002	Cot. arena oscura Dark sand cotonet Cotonet sable sombre
3144	4158	4166	RAL 9002	Cotonet sand Sand cotonet Cotonet sand
3145	4159	4167	RAL 9002	Cotonet blanco White cotonet Cotonet blanc
3146	4160	4168	RAL 9005	Cotonet gris frío Cold gray cotonet Cotonet gris froid
3167	4216	4218	RAL 9005	Cot. arena oscura Dark sand cotonet Cotonet sable sombre
3148	4162	4170	RAL 9005	Cotonet sand Sand cotonet Cotonet sand
3149	4163	4171	RAL 9005	Cotonet blanco White cotonet Cotonet blanc

Kea

Luxcambra Team

La intención de esta colección es crear un producto de máxima simplicidad representada con un cuerpo cilíndrico suspendido con una luz directa hacia abajo perfecta.

The intention of this collection is to create a product of maximum simplicity represented by a cylindrical body diffusing the perfect direct downward LED light.

L'intention de cette collection est de créer un produit d'une simplicité maximale, représentée par un corps cylindrique diffusant une lumière LED directe parfaite.



Familia / Family / Famille

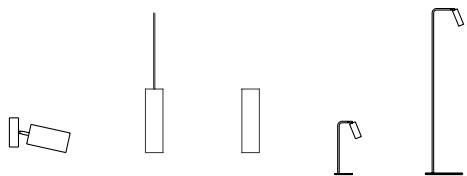







Kea a / Kea c / Kea pl

Estructura en blanco, negro o color RAL. Cable de algodón eléctrico negro o blanco.

White, black or RAL structure. Black or white electrical cotton cable.

Structure en blanc, noir ou RAL. Câble électrique en coton noir ou blanc.



GU-10 LED 8W



BIM/3D files: luxcambra.com/3D (3ds, dwg, 3dm, skp, rfa)

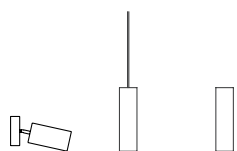
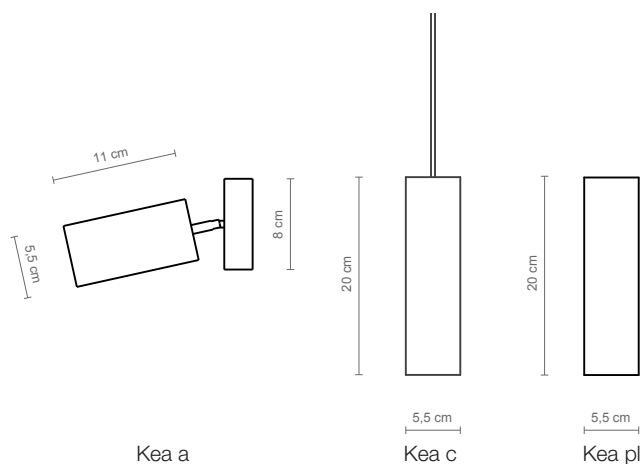

2342 1287

● Negro texturado RAL 9005
Textured black RAL 9005
Noir texturé RAL 9005

2343 1288

● Blanco mate texturado RAL 9016
Textured matt white RAL 9016
Blanc mat texturé RAL 9016

2345 1290

○ Color RAL
RAL color
Couleur RAL

1282

● Negro texturado RAL 9005
Textured black RAL 9005
Noir texturé RAL 9005

Algodón negro
Black cotton
Coton noir

1283

● Blanco mate texturado RAL 9016
Textured matt white RAL 9016
Blanc mat texturé RAL 9016

Algodón blanco
White cotton
Coton blanc

1284

● Blanco mate texturado RAL 9016
Textured matt white RAL 9016
Blanc mat texturé RAL 9016

Algodón negro
Black cotton
Coton noir

1286

○ Color RAL
RAL color
Couleur RAL

Algodón negro
Black cotton
Coton noir

ESTRUCTURA Y FLORÓN
STRUCTURE AND CEILING SUPPORT
STRUCTURE ET SUPPORT PLAFOND

CABLE
CABLE
CÂBLE

Kea s / Kea p

Estructura en blanco o negro. Cable eléctrico de PVC negro.

White or black structure. Black electrical PVC cable.

Structure en blanc ou noir. Câble électrique en PVC noir.



GU-10 LED 8W



BIM/3D files: luxcambra.com/3D (3ds, dwg, 3dm, skp, rfa)

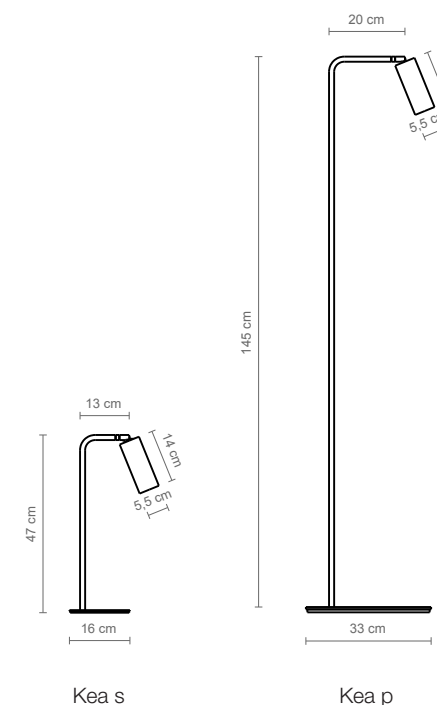

Kea s

Kea p

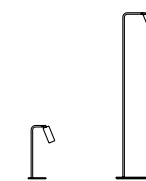

3188 4220

● Negro texturado RAL 9005
Textured black RAL 9005
Noir texturé RAL 9005

● Negro
Black
Noir

PVC negro
Black PVC
PVC noir

3189 4221

● Blanco mate texturado RAL 9016
Textured mat white RAL 9016
Blanc cassé texturé RAL 9016

● Blanco
White
Blanc

PVC negro
Black PVC
PVC noir

3190 4222

● Negro texturado RAL 9005
Textured black RAL 9005
Noir texturé RAL 9005

● Dorado
Golden
Doré

PVC negro
Black PVC
PVC noir

ESTRUCTURA
STRUCTURE
STRUCTURE

FOCO
SPOT
SPOT

CABLE
CABLE
CÂBLE

Kito

Xavier Solé

La intención del diseño de esta colección es crear un producto con carácter nórdico, sencillo, sobrio y elegante. La neutralidad de su diseño permite que sea apto para diferentes tipos de ambientes. El contrachapado multicapa y la tecnología adecuada permiten curvar la madera con el mínimo espesor posible y gracias a la tecnología LED, se consigue que la fuente lumínica ocupe el mínimo espacio y grosor.

This collection was inspired by nordic lightings, known to be minimal, refined and elegant. This neutral design makes them fit in any type of environment. The curved plywood shape creates a light and thin hanging lamp, reinforced by the LED strips occupying a minimal space while widely diffusing light.

Le design de cette collection a été conçu dans l'optique d'un produit nordique, à la fois simple, sobre et élégant. Sa neutralité convient à tout type d'environnement. L'alliance entre le contreplaqué et la technologie LED permet d'obtenir un abat-jour incurvé et fin. Les bandes LED incorporées à l'intérieur occupent également un minimum d'espace, tout en optimisant la diffusion de la lumière.

Familia / Family / Famille

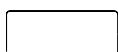
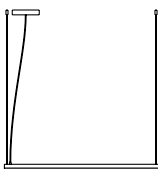



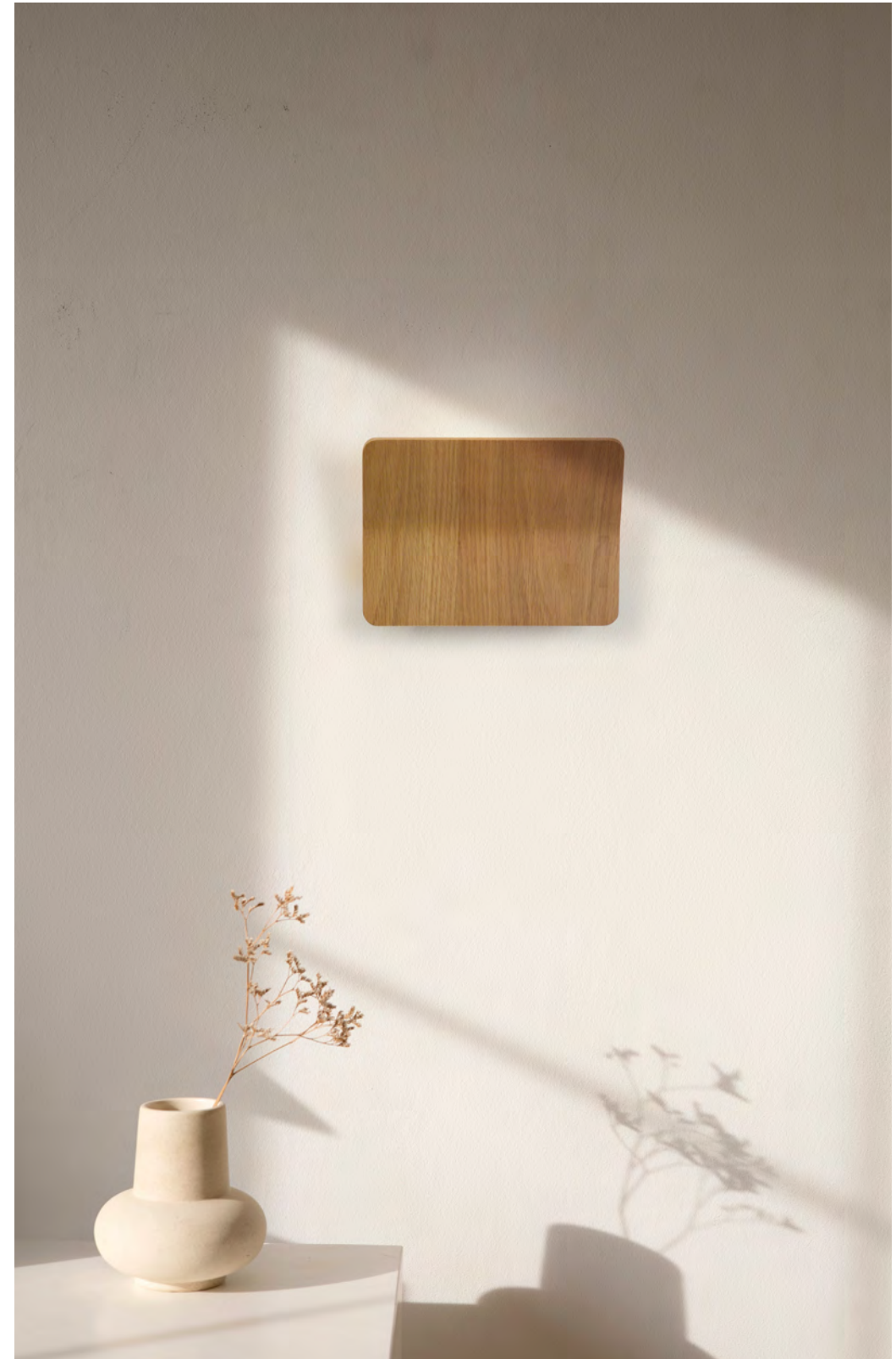

Kito a

Estructura en blanco. Pantalla de madera de roble. White structure. Oak wood lampshade.

Structure en blanc. Abat-jour en bois de chêne.



Tira LED 6W
600lm / 3.000K
(Kito a)



G-9 LED 8W
(Kito a XS)



BIM/3D files: luxcambra.com/3D (3ds, dwg, 3dm, skp, rfa)



Tira LED 8W
700lm / 3.000K
(Kito a doble)

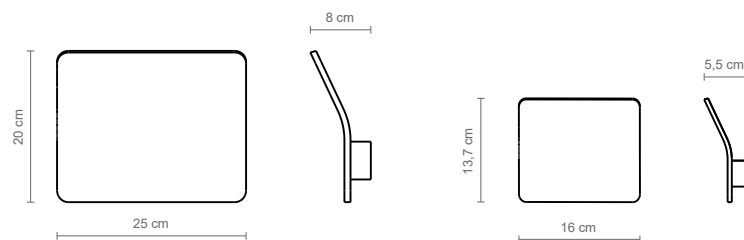

Kito a

Kito a XS

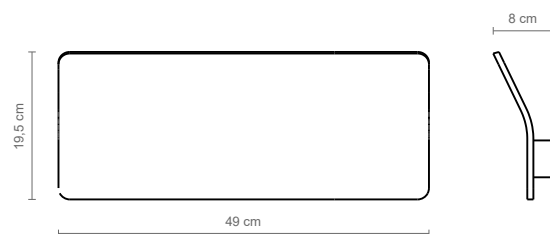

Kito a doble



2005



2006

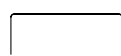

2007

ESTRUCTURA
STRUCTURE
STRUCTURE

Blanco RAL 9016
White RAL 9016
Blanc RAL 9016

PANTALLA
LAMP SHADE
ABAT-JOUR

Madera de roble
Oak wood
Bois de chêne

Kito c

Estructura en blanco. Pantalla de madera de roble. White structure. Oak wood lampshade. White electrical cotton cable.

Structure en blanc. Abat-jour en bois de chêne. Cable électrique en coton blanc.



Tira LED 13W
1000lm / 3.000K
(Kito c 80 cm)



Tira LED 20W
1500lm / 3.000K
(Kito c 80 cm)



BIM/3D files: luxcambra.com/3D (3ds, dwg, 3dm, skp, rfa)

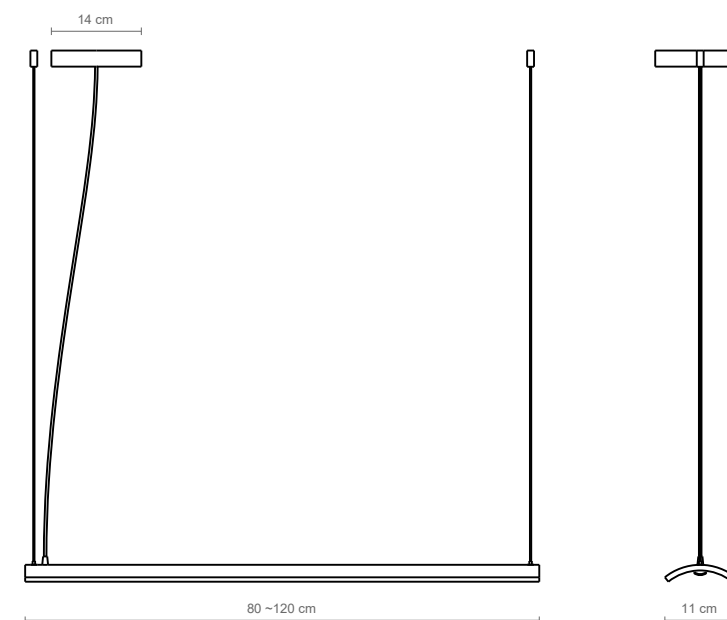

	FLORÓN CEILING SUPPORT SUPPORT PLAFOND	PANTALLA LAMP SHADE ABAT-JOUR	LONGITUD LENGTH LONGUEUR	CABLE CABLE CÂBLE
1034	Blanco RAL 9016 White RAL 9016 White RAL 9016	Madera de roble Oak wood Bois de chêne	80 cm	Algodón blanco White cotton Coton blanc
1035	Blanco RAL 9016 White RAL 9016 White RAL 9016	Madera de roble Oak wood Bois de chêne	120 cm	Algodón blanco White cotton Coton blanc

Line

Luxcambra Team

El aplique Line se fabrica en diferentes acabados: blanco, negro, níquel y óxido y todas sus variantes tienen luz superior e inferior. Se trata de una pieza muy versátil y apropiada tanto para uso doméstico como para proyectos contract.

The Line wall lamp is available in various finishes: white, black, nickel and oxide. All versions have upper and lower lighting. It is a very versatile lamp that is suitable for both domestic use and contract projects.

L'applique murale Line est disponible en différentes finitions : blanc, noir, nickel et oxyde. Toutes ses variantes ont un éclairage supérieur et inférieur. Il s'agit d'une lampe très polyvalente qui convient aussi bien pour un usage domestique ou des projets contract.



Familia / Family / Famille





Line

Estructura en blanco, negro o color RAL. Cristal translúcido.

White, black or RAL structure. Translucent glass.

Structure en blanc, noir ou RAL. Verre translucide.



E-27 LED 12W
(Line 30)



3 x E-27 LED 12W
(Line 80)



BIM/3D files: luxcambra.com/3D (3ds, dwg, 3dm, skp, rfa)



Line 30

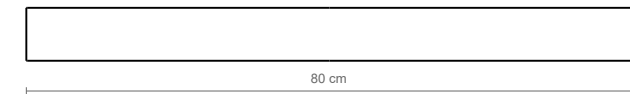
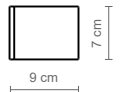

Line 80

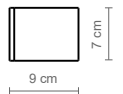

ESTRUCTURA
STRUCTURE
STRUCTURE

2145

2149



Níquel
Nickel
Nickel

2146

2150



Óxido
Oxide
Oxyde

2147

2151



Negro texturado RAL 9005
Textured black RAL 9005
Noir texturé RAL 9005

2148

2152



Blanco mate texturado RAL 9016
Textured matt white RAL 9016
Blanc mat texturé RAL 9016

2524

2525



Color RAL
RAL color
Couleur RAL

Lula

Luxcambra Team

La colección Lula se fabrica en blanco y negro. Con su pantalla metálica articulada se trata de una pieza muy versátil y apropiada tanto para uso doméstico como para proyectos contract.

The Lula collection is available in white and black. Its articulated metal shade makes it a very versatile piece, suitable for both domestic use and contract projects.

La collection Lula est disponible en blanc et en noir. Son abat-jour métallique articulé en fait une pièce très polyvalente qui convient aussi bien à un usage domestique qu'à des projets contract.

Familia / Family / Famille

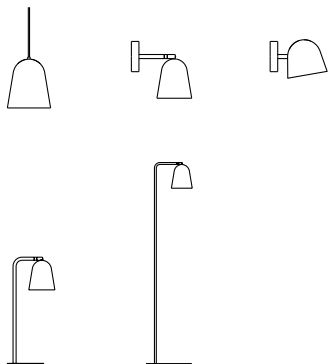



Se incorpora a la colección un nuevo aplique más compacto y con una rótula integrada que potencia su funcionalidad.

We incorporated a new more compact wall lamp into the collection, with an integrated ball joint that enhances its functionality.

Une nouvelle applique murale plus compacte a été incorporée à la collection, avec une rotule intégrée qui améliore sa fonctionnalité.





Lula a / Lula c

Estructura en blanco o negro. Pantalla metálica articulada. Cable eléctrico de PVC negro o blanco.

White, or black structure. Articulated metal lampshade. Black or white electrical PVC cable.

Structure en blanc ou noir. Abat-jour métallique articulé. Câble électrique PVC noir ou blanc.



E-27 LED 12W



BIM/3D files: luxcambra.com/3D (3ds, dwg, 3dm, skp, rfa)

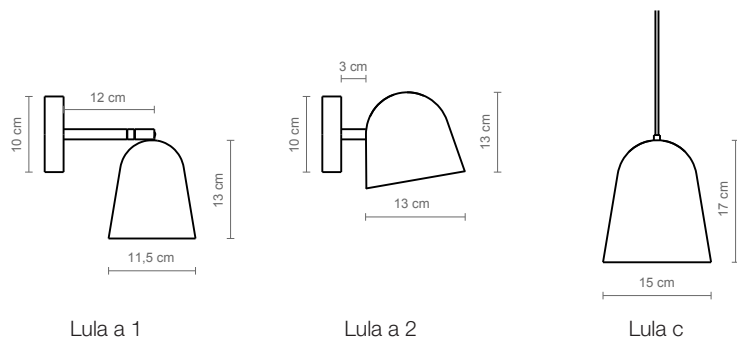

		ESTRUCTURA STRUCTURE STRUCTURE	CABLE CABLE CÂBLE
2329	2869	● Negro texturado RAL 9005 Textured black RAL 9005 <i>Noir texturé RAL 9005</i>	
2330	2870	● Blanco mate texturado RAL 9016 Textured matt white RAL 9016 <i>Blanc mat texturé RAL 9016</i>	
	1689	● Negro texturado RAL 9005 Textured black RAL 9005 <i>Noir texturé RAL 9005</i>	PVC negro Black PVC <i>PVC noir</i>
	1690	● Blanco mate texturado RAL 9016 Textured matt white RAL 9016 <i>Blanc mat texturé RAL 9016</i>	PVC blanco White PVC <i>PVC blanc</i>

Lula s / Lula p

Estructura en blanco o negro. Cable eléctrico de PVC negro o blanco.

White, or black structure. Black or white electrical PVC cable.

Structure en blanc ou noir. Câble électrique en PVC noir ou blanc.



E-27 LED 12W



BIM/3D files: luxcambra.com/3D (3ds, dwg, 3dm, skp, rfa)

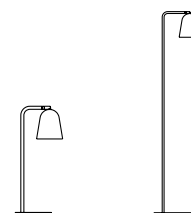
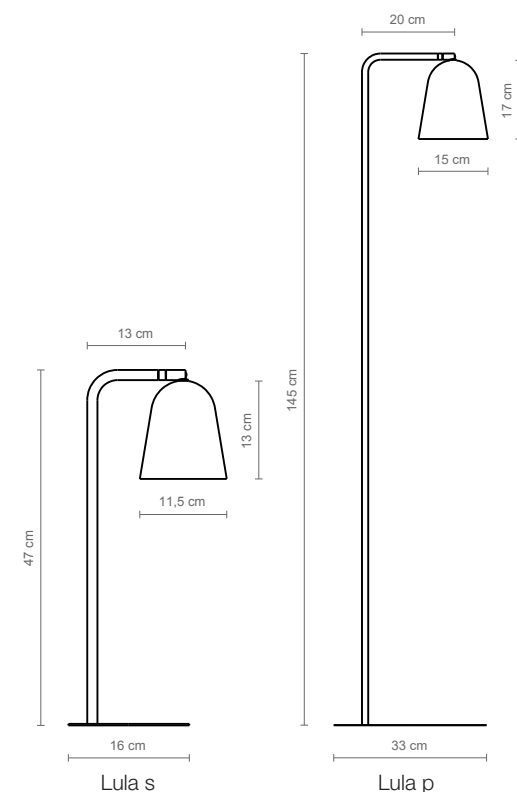

		ESTRUCTURA STRUCTURE STRUCTURE	CABLE CABLE CÂBLE
3015	4008	● Blanco mate texturado RAL 9016 Textured matt white RAL 9016 <i>Blanc mat texturé RAL 9016</i>	PVC blanco White PVC <i>PVC blanc</i>
3016	4009	● Negro texturado RAL 9005 Textured black RAL 9005 <i>Noir texturé RAL 9005</i>	PVC negro Black PVC <i>PVC noir</i>

Lymington

Luxcambra Team

El aplique Lymington con su globo de cristal inspirado en el diseño vintage se fabrica en tres formatos y en diferentes acabados: blanco, negro y dorado. Se trata de una pieza muy versátil y apropiada tanto para uso doméstico como para proyectos de restauración.

The Lymington wall lamp with its glass globe inspired by vintage design is available in three formats and in different finishes: white, black or gold. It is a highly versatile piece that is suitable for both domestic use and catering projects.

L'applique Lymington avec son globe en verre d'inspiration vintage est disponible en trois formats et en différentes finitions : blanc, noir ou doré. Il s'agit d'une pièce très polyvalente qui convient aussi bien à un usage domestique qu'à des projets de restauration.

Familia / Family / Famille

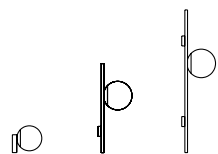

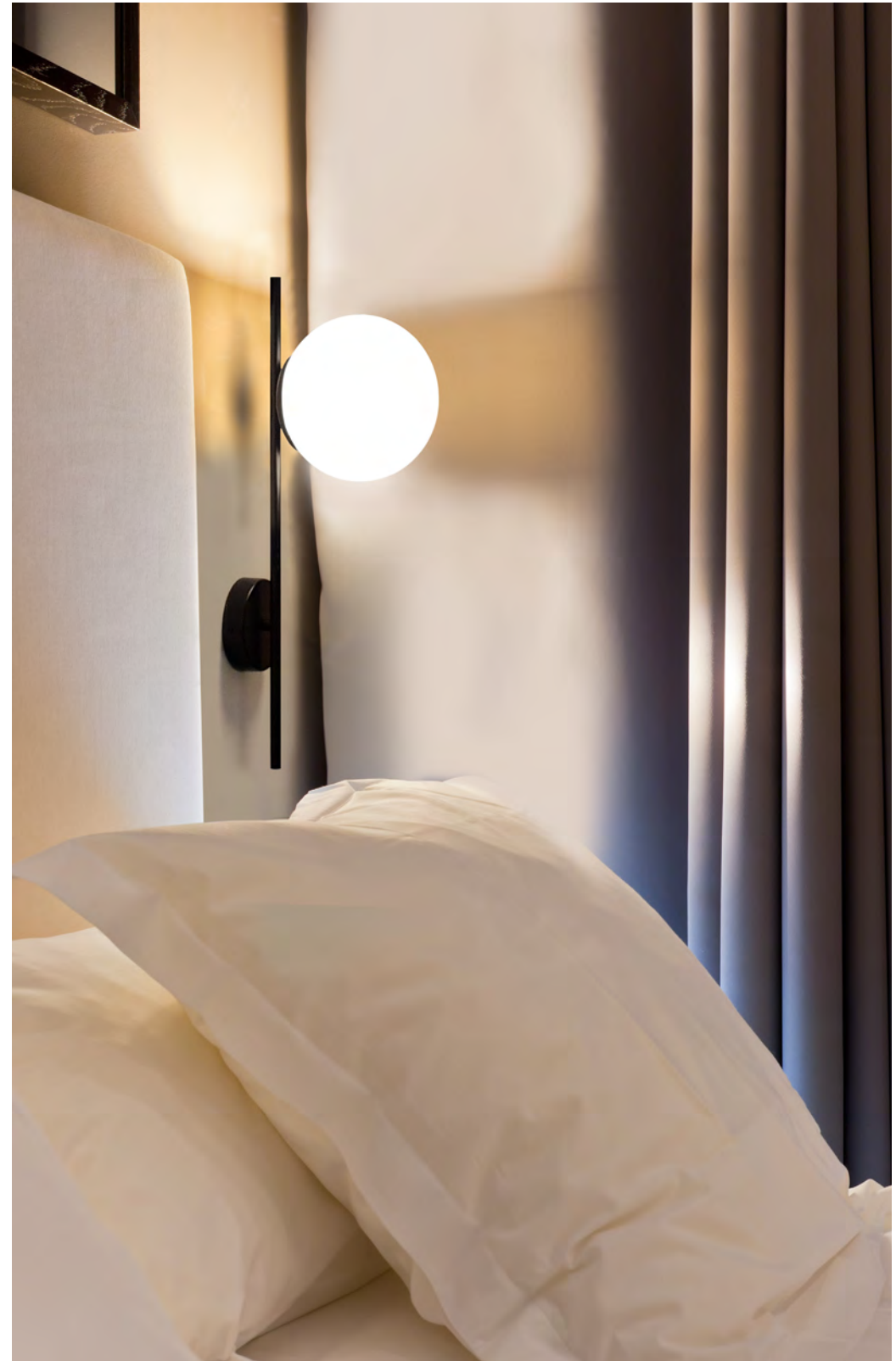



Lymington a

Estructura en dorado, blanco o negro. Globo opalizado mate. Disponible con globo opal triplex mate.

Gold, white or black structure. Opal matt globe. Available with triplex opal matt globe.

Structure en doré, blanc ou noir. Globe mat opale. Disponible en globe triplex mat opale.



E-14 LED 12W
(Lymington S)



E-27 LED 12W
(Lymington M)
(Lymington L)



BIM/3D files: luxcambra.com/3D (3ds, dwg, 3dm, skp, rfa)

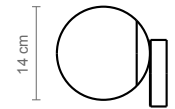

Lymington S

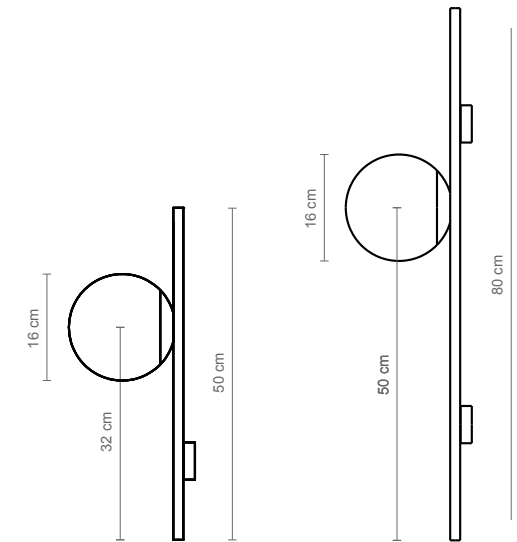

Lymington M

Lymington L

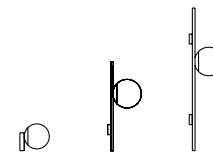

2311 2526 2317

2313 2528 2319

2315 2530 2321

ESTRUCTURA
STRUCTURE
STRUCTURE

● Dorado
Gold | Doré

● Blanco RAL 9016
White RAL 9016 | Blanc RAL 9016

● Negro RAL 9005
Black RAL 9005 | Noir RAL 9005

GLOBO
GLOBE
GLOBE

● Opal
Opal | Opale

● Opal
Opal | Opale

● Opal
Opal | Opale

Mad

Xavier Solé

La colección MAD es una revisión de las clásicas lámparas con pantallas de policarbonato de los años 60 y ha sido diseñada para que se adapte a los espacios contemporáneos actuales donde los materiales naturales y orgánicos tienen cada vez más protagonismo. El diseñador Xavier Solé ha sabido dar al producto un aire clásico con acento nórdico. El equilibrio y la sofisticación se funden en la simplicidad con la integración de sus 2 componentes. La serie está compuesta por 2 esferas de diámetros 24 y 35 cm de buena opacidad y luminosidad.

The MAD collection is a revision of the classic lamps with polycarbonate shades from the 60s and it was designed to adapt to the current contemporary spaces where natural and organic materials are increasingly prominent. The designer Xavier Solé managed to combine within the product a classic design with a touch of Nordic style. A sense of balance and sophistication merges in simplicity thanks to the integration of its 2 components. The series is made up of 2 spheres with a diameter of 24 or 35 cm, with full opacity and luminosity.

La collection MAD est une récréation des lampes classiques avec des abat-jours en polycarbonate des années 60, elle a été conçue pour s'adapter aux espaces contemporains actuels où les matériaux naturels et organiques sont de plus en plus présents. Le designer Xavier Solé a réussi à donner au produit un style classique avec un accent nordique. L'équilibre et la sophistication se fondent dans la simplicité de l'intégration de ses 2 composants. La série est composée de 2 sphères de diamètres 24 et 35 cm de bonne opacité et luminosité.

Familia / Family / Famille

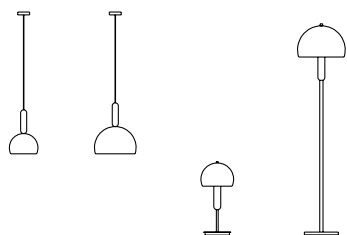





Mad c

Estructura en blanco con pieza de madera de haya.
Cable eléctrico de algodón blanco.

White structure with piece of beech wood.
electrical cotton cable.

Structure en blanc avec pièce de bois d'hêtre. Câble électrique en coton blanc.



E-27 LED 12W



BIM/3D files: luxcambra.com/3D (3ds, dwg, 3dm, skp, rfa)

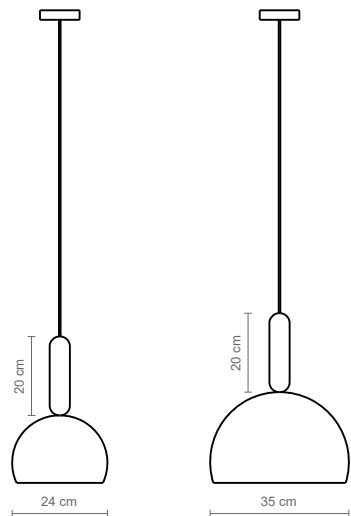

Mad c S

Mad c L

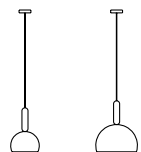

1418 1419

FLORÓN
CEILING SUPPORT
SUPPORT PLAFOND

Blanco RAL 9016
White RAL 9016
Blanc RAL9016

PANTALLA
LAMP SHADE
ABAT-JOUR

Polícarbonato
Polycarbonate
Polycarbonate

CABLE
CABLE
CÂBLE

Algodón blanco
White cotton
Coton blanc

Mad s / Mad p

Estructura en blanco o negro con pieza de
madera de haya. Cable eléctrico de PVC negro o
transparente.

White or black structure with piece of beech
wood. Black or transparent electrical cable.

Structure en blanc ou noir avec pièce de bois d'hêtre.
Câble PVC noir ou transparent.



E-27 LED 12W
(Mad s)



2 x E-27 LED 12W
(Mad p)



BIM/3D files: luxcambra.com/3D (3ds, dwg, 3dm, skp, rfa)

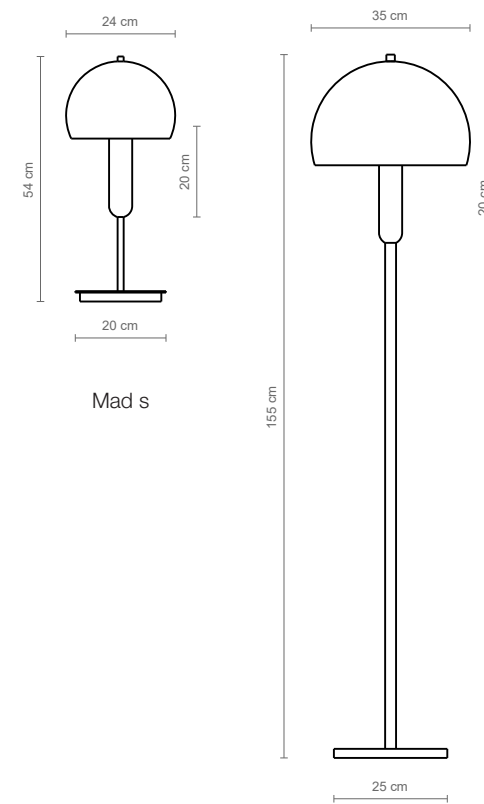

Mad s

Mad p

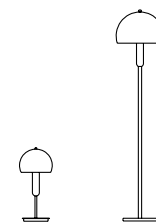

3161 4204

ESTRUCTURA
STRUCTURE
STRUCTURE

Blanco RAL 9016
White RAL9016
Blanc RAL9016

PANTALLA
LAMP SHADE
ABAT-JOUR

Polícarbonato
Polycarbonate
Polycarbonate

CABLE
CABLE
CÂBLE

Transparente
Transparent
Transparent

3162 4205

Negro RAL 9005
Black RAL 9005
Noir RAL 9005

Polícarbonato
Polycarbonate
Polycarbonate

PVC negro
Black PVC
PVC noir

Manhattan

Luxcambra Team

La colección Manhattan es funcional y versátil. Su potente foco lector puede dirigirse en cualquier dirección y resulta ideal tanto para uso doméstico como para proyectos de restauración.

El aplique se adapta a las necesidades de cada proyecto y se fabrica en acabados especiales, con o sin entrada de USB integrada, con la posibilidad de empotrarse a la pared, con luz LED trasera indirecta opcional, con sistema de encendido por contacto con el foco lector opcional, con interruptores especiales y con soporte circular o rectangular.

The Manhattan collection is functional and versatile. Its powerful led reader can be directed in any direction and is ideal for both domestic use and restoration projects.

The wall lamp can be adapted to the needs of each project, it is produced in special finishes, with or without integrated USB input, with recessed light fixture, with optional indirect LED light, with touch control system to switch on the reader, with special switches or with circular or rectangular support.

La collection Manhattan est fonctionnelle et polyvalente. Son lecteur led puissant peut être orienté dans n'importe quelle direction et est idéal pour des particuliers tout comme des projets de rénovation.

L'applique s'adapte aux besoins de chaque projet, elle est fabriquée dans des finitions spéciales, avec ou sans port USB intégré, avec possibilité d'encastrement dans le mur, avec option d'éclairage indirect LED, avec système d'allumage par contact avec le lecteur, avec interrupteurs spéciaux ou avec support circulaire ou rectangulaire.

Familia / Family / Famille

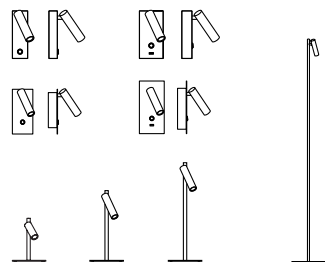



Aplique Manhattan de superficie sin USB.
Surface Manhattan wall lamp without USB.
Applique Manhattan de superficie sans USB.



Aplique Manhattan empotrable sin USB.
Recessed Manhattan wall lamp without USB.
Applique Manhattan encastré sans USB.



Aplique Manhattan de superficie con USB.
Surface Manhattan wall lamp with USB.
Applique Manhattan de superficie avec USB.



Aplique Manhattan empotrable con USB.
Recessed Manhattan wall lamp with USB.
Applique Manhattan encastré avec USB.



El aplique Manhattan se adapta a las necesidades de cada proyecto:

Acabados especiales (colores RAL, cromo, cobre, dorado, óxido,...)

Foco lector redondo o XL

Con luz led trasera indirecta

Medidas especiales

Interruptores especiales

Soporte circular o cuadrado

Con sistema de encendido por contacto con el foco lector

The wall lamp can be adapted to the needs of each project:

Special finishes (RAL colors, chrome, copper, golden, weathering steel,...)

Round or XL reader

With indirect back led light

Special sizes

Special switches

Circular or square support

With ON/OFF system by contact with the reader

L'applique s'adapte aux besoins de chaque projet:

Finitions spéciales (couleurs ral, chrome, cuivre, doré, acier corten,...)

Lecteur rond ou XL

Avec rétro-éclairage indirect

Dimensions spéciales

Interrupteurs spéciaux

Support circulaire ou carré

Avec système d'allumage par contact avec le lecteur



10,5 cm 2,5 cm

Con foco lector standard.
With standard reader.
Avec lecteur standard.



10,5 cm 2,5 cm

Con foco lector cuadrado.
With square reader.
Avec lecteur carré.



12,5 cm

Con foco lector XL.
With XL reader.
Avec lecteur XL.



Con base redonda.
With round base.
Avec base ronde.



Con interruptor especial y en color RAL.
With special switch and RAL color.
Avec interrupteur spécial et avec couleur RAL.



Con sistema on/off mediante presión.
With on / off system by pressing.
Avec système on / off en appuyant.







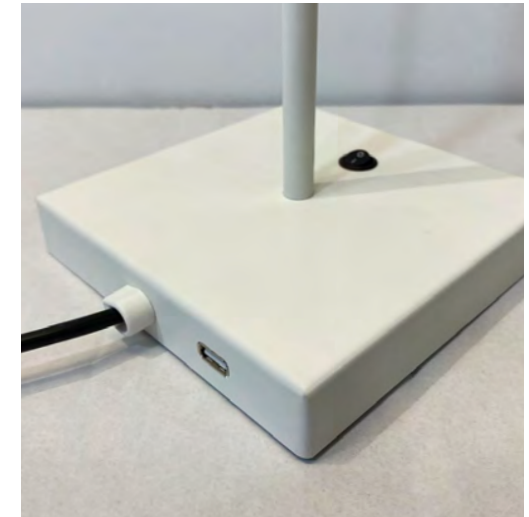

Las lámparas de pie y sobremesas Manhattan se adaptan a las necesidades de cada proyecto:

Acabados especiales

Interruptor integrado en el tubo para la lámpara de pie

Puerto USB integrado en la base para la lámpara de sobremesa. Disponible USB tipo B o C

Base cuadrada o circular

The floor lamps and table lamps can be adapted to the needs of each project:

Special finishes

Built-in switch in the tube for the floor lamp
USB port integrated to the base of the table lamp.

Available USB B-type or C-type

Circular or square base

Les lampadaires et les lampes à poser s'adaptent aux besoins de chaque projet:

Finitions spéciales

Interrupteur spécial intégré sur le tube pour la lampe de pied

Port USB type B ou type C

Base circulaire ou carrée

Manhattan a

Estructura en blanco o negro.

White or black structure.

Structure en blanc ou noir.



LED 3W
150 lm / 2.700K



BIM/3D files: luxcambra.com/3D (3ds, dwg, 3dm, skp, rfa)

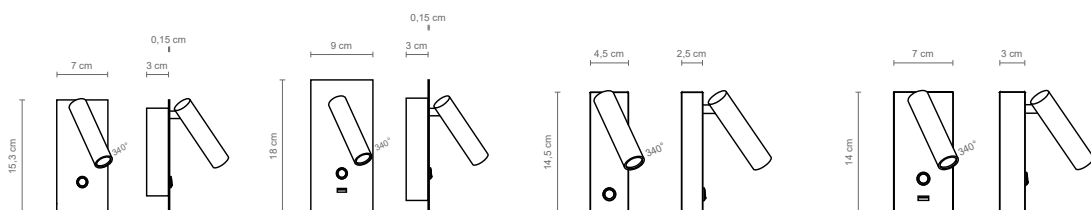

MANHATTAN A SIN USB:

De superficie, 4,5 x 14,5 x 2,5 cm. Foco lector 10,5 cm y diámetro 2,8 cm.

Empotrado, medidas exteriores 7 x 15,3 cm. Plancha de 1,5 mm visible y caja trasera empotrada de 5 x 12 x 3 cm.

MANHATTAN A CON USB 5 V - 2,1 A:

De superficie, 7 x 14 x 3 cm. Foco lector 10,5 cm y diámetro 2,8 cm.

Empotrado, medidas exteriores 8,5 x 18 cm. Plancha de 1,5 mm visible y caja interior empotrada de 7 x 14 x 3 cm.

MANHATTAN A WITHOUT USB:

Surface version, 4,5 x 14,5 x 2,5 cm. Led reader 10,5 cm and diameter 2,8 cm.

Recessed version, external sizes 7 x 15,3 cm. Visible plate of 1,5 mm and recessed back box of 5 x 12 x 3 cm.

MANHATTAN A WITH USB 5 V - 2,1 A:

Surface version, 7 x 14 x 3 cm. Led reader 10,5 cm and diameter 2,8 cm.

Recessed version, external sizes 8,5 x 18 cm. Visible plate of 1,5 mm and recessed back box of 7 x 14 x 3 cm.

MANHATTAN A SANS USB:

Versión de superficie, 4,5 x 14,5 x 2,5 cm. Lecteur led 10,5 cm et diamètre 2,8 cm.

Versión encastrable, mesures extérieures 7 x 15,3 cm.

Plaque visible de 1,5 mm et boîte encastrée de 5 x 12 x 3 cm

MANHATTAN A AVEC USB 5 V - 2,1 A:

Versión de superficie, 7 x 14 x 3 cm. Lecteur led 10,5 cm et diamètre 2,8 cm.

Versión encastrable, mesures extérieures 8,5 x 18 cm. Plaque visible de 1,5 mm et boîte encastrée de 7 x 14 x 3 cm.



2017	2020	2353	2356	ESTRUCTURA STRUCTURE STRUCTURE Blanco mate texturado RAL 9016 Textured matt white RAL 9016 Blanc RAL 9016
------	------	------	------	--

2018	2021	2354	2357	Negro texturado RAL 9005 Textured black RAL 9005 Noir texturé RAL 9005
------	------	------	------	--

Manhattan s / Manhattan p

Estructura en blanco, negro o negro dorado. Cable eléctrico de PVC negro.

White, black or black and gold structure. Black electrical PVC cable.

Structure en blanc, noir ou noir et doré. Câble électrique PVC noir.



LED 3W
150 lm / 2.700K



BIM/3D files: luxcambra.com/3D (3ds, dwg, 3dm, skp, rfa)

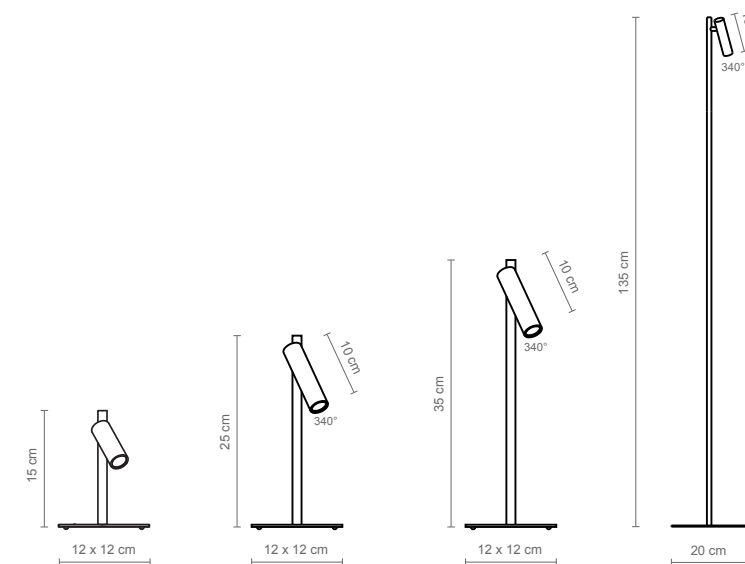

Manhattan s XS

Manhattan s S

Manhattan s L

Manhattan p

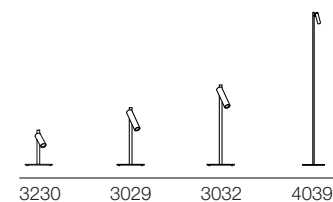

3230	3029	3032	4039
------	------	------	------

3231	3030	3033	4040
------	------	------	------

3233	3183	3184	4219
------	------	------	------

ESTRUCTURA
STRUCTURE
STRUCTURE

Blanco mate texturado RAL 9016 Textured matt white RAL 9016 Blanc mat texturé RAL 9016
--

Negro texturado RAL 9005 Textured black RAL 9005 Noir texturé RAL 9005
--

Negro y dorado Black and gold Noir et doré
--

Matrix

Luxcambra Team

Las lámparas de la colección Matrix con sus brazos articulados que se extienden formando un ángulo recto perfecto se adaptan muy bien a cualquier espacio. Su rótula permite el giro horizontal de la pantalla y permite acercarla o alejarla a voluntad.

The lamps of the Matrix collection with their articulated and extendable arms forming a perfect right angle adapt very well to any space. Its swivel joint allows the horizontal rotation of the shade to bring it closer or further away.

Les lampes de la collection Matrix avec leurs bras articulés qui s'étendent pour former un angle droit parfait, s'adaptent très bien à n'importe quel espace. La rotule permet la rotation horizontale de l'abat-jour pour le rapprocher ou l'éloigner selon les besoins.

Familia / Family / Famille

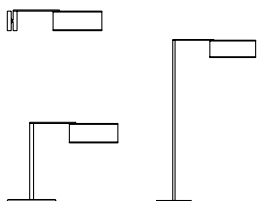





La colección Matrix se caracteriza por la singularidad de su brazo giratorio que aporta carácter y funcionalidad.

The Matrix collection is characterized by the singularity of its rotating arm which provides character and functionality.

La collection Matrix se caractérise par la singularité de son bras rotatif qui fournit du caractère et de la fonctionnalité.

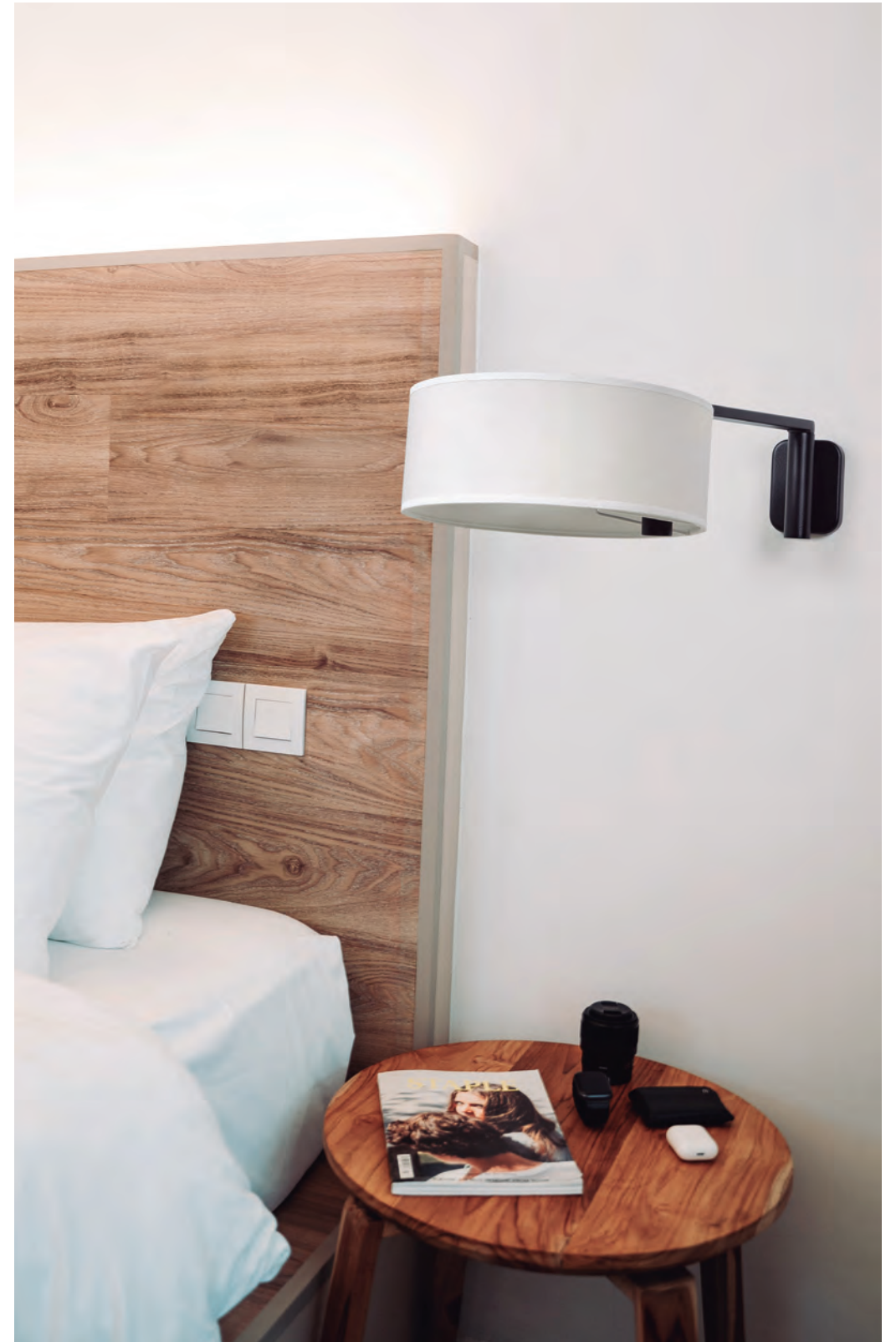



Matrix s / Matrix p

Estructura en blanco o negro. Pantalla de cotonet o osaka. Cable eléctrico de PVC negro o transparente.

White or black structure. Cotonet or osaka lampshade. Black or transparent electrical PVC cable.

Structure en blanc ou noir. Abat-jour en cotonet ou osaka. Câble électrique PVC noir ou transparent.



E-27 LED 12W



BIM/3D files: luxcambra.com/3D (3ds, dwg, 3dm, skp, rfa)

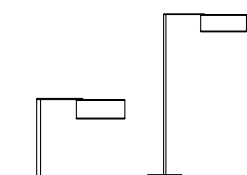
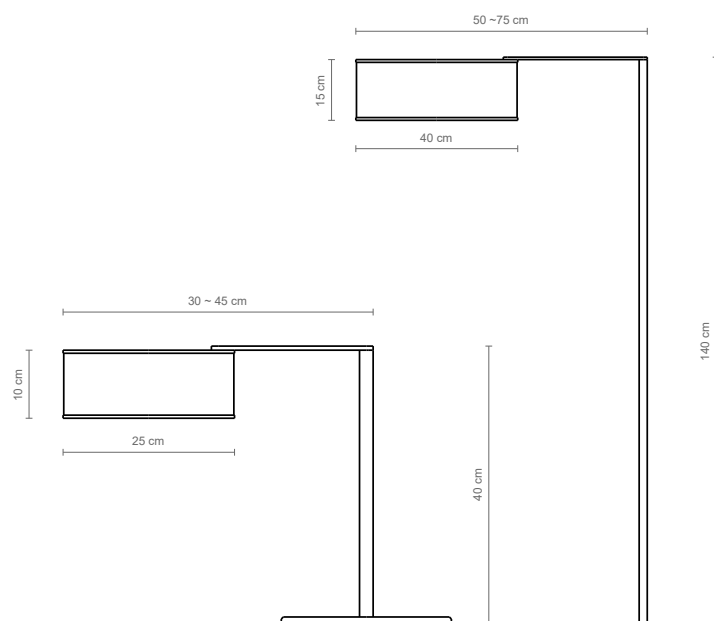

		ESTRUCTURA STRUCTURE STRUCTURE	PANTALLA LAMP SHADE ABAT-JOUR
3198	4230	Blanco RAL 9016 White RAL 9016 Blanc RAL 9016	Osaka Osaka Osaka
3199	4231	Blanco RAL 9016 White RAL 9016 Blanc RAL 9016	Cotonet blanco White cotonet Cotonet blanc
3200	4232	Blanco RAL 9016 White RAL 9016 Blanc RAL 9016	Cot. arena oscura Dark sand cotonet Cotonet sable sombre
3201	4233	Blanco RAL 9016 White RAL 9016 Blanc RAL 9016	Cotonet gris frío Cold grey cotonet Cotonet gris froid
3202	4234	Blanco RAL 9016 White RAL 9016 Blanc RAL 9016	Cotonet sand Sand cotonet Cotonet sand
3203	4235	Negro RAL 9005 Black RAL 9005 Noir RAL 9005	Osaka Osaka Osaka
3204	4236	Negro RAL 9005 Black RAL 9005 Noir RAL 9005	Cotonet blanco White cotonet Cotonet blanc
3205	4237	Negro RAL 9005 Black RAL 9005 Noir RAL 9005	Cot. arena oscura Dark sand cotonet Cotonet sable sombre
3206	4238	Negro RAL 9005 Black RAL 9005 Noir RAL 9005	Cotonet gris frío Cold grey cotonet Cotonet gris froid
3207	4239	Negro RAL 9005 Black RAL 9005 Noir RAL 9005	Cotonet sand Sand cotonet Cotonet sand

Matrix a

Estructura en blanco o negro. Pantalla de cotonet o osaka.

White or black structure. Cotonet or osaka lampshade.

Structure en blanc ou noir. Abat-jour en cotonet ou osaka.



E-27 LED 12W



BIM/3D files: luxcambra.com/3D (3ds, dwg, 3dm, skp, rfa)

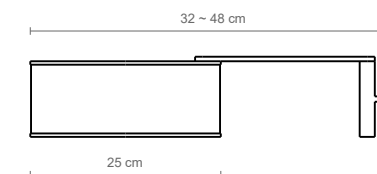

		ESTRUCTURA STRUCTURE STRUCTURE	PANTALLA LAMP SHADE ABAT-JOUR
2602		Blanco RAL 9016 White RAL 9016 Blanc RAL 9016	Osaka Osaka Osaka
2603		Blanco RAL 9016 White RAL 9016 Blanc RAL 9016	Cotonet blanco White cotonet Cotonet blanc
2604		Blanco RAL 9016 White RAL 9016 Blanc RAL 9016	Cot. arena oscura Dark sand cotonet Cotonet sable sombre
2605		Blanco RAL 9016 White RAL 9016 Blanc RAL 9016	Cotonet gris frío Cold grey cotonet Cotonet gris froid
2606		Blanco RAL 9016 White RAL 9016 Blanc RAL 9016	Cotonet sand Sand cotonet Cotonet sand
2607		Negro RAL 9005 Black RAL 9005 Noir RAL 9005	Osaka Osaka Osaka
2608		Negro RAL 9005 Black RAL 9005 Noir RAL 9005	Cotonet blanco White cotonet Cotonet blanc
2609		Negro RAL 9005 Black RAL 9005 Noir RAL 9005	Cot. arena oscura Dark sand cotonet Cotonet sable sombre
2610		Negro RAL 9005 Black RAL 9005 Noir RAL 9005	Cotonet gris frío Cold grey cotonet Cotonet gris froid
2611		Negro RAL 9005 Black RAL 9005 Noir RAL 9005	Cotonet sand Sand cotonet Cotonet sand

Matrix led

Luxcambra Team

El LED se combina con la sobriedad de las líneas depuradas de una estructura metálica que forma un perfecto ángulo recto. El brazo orientable con una tira LED ilumina con un flujo de luz amplio y regular.

Esta colección minimalista y versátil es perfecta para un rincón de lectura y la neutralidad de su diseño permite que sea apta para diferentes ambientes.

The LED technology is combined with the pure lines of a metallic structure which forms a perfect right angle. The orientable arm including a LED strip diffuses a wide regular flow of light.

This collection is perfect for reading spaces and its neutral design makes it suitable for different environments.

La technologie LED est combinée aux lignes pures d'une structure métallique pour former un angle droit parfait. Le bras orientable incluant une bande LED illumine d'un flux de lumière régulier et dense.

Cette collection minimaliste et versatile est idéale pour un coin lecture et sa neutralité la rend apte à tout type d'environnement.

Familia / Family / Famille

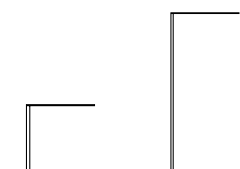





Matrix led s / Matrix led p

Estructura en blanco o negro. Cable PVC negro.

White or black structure. Black PVC cable.

Structure en blanc ou noir. Câble PVC noir.



Tira LED 7W
600lm / 3.000K
(Matrix led s)



Tira LED 11W
900lm / 3.000K
(Matrix led p)



BIM/3D files: luxcambra.com/3D (3ds, dwg, 3dm, skp, rfa)

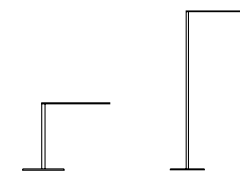
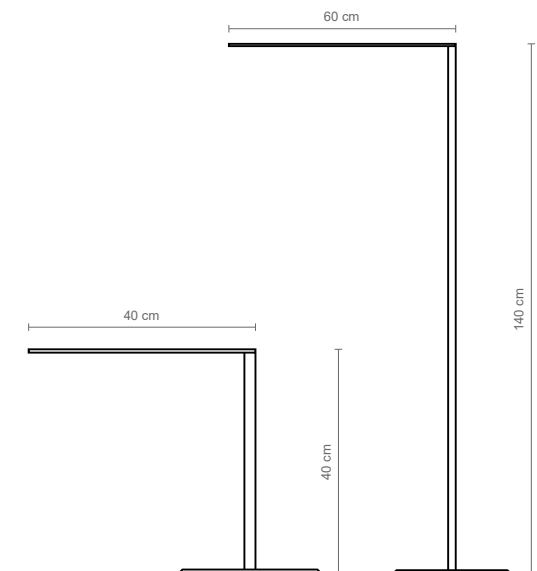

3035

4042

ESTRUCTURA
STRUCTURE
STRUCTURE

● Blanco mate texturado RAL 9016
Textured matt white RAL 9016
Blanc mat texturé RAL 9016

CABLE
CABLE
CÂBLE

● PVC negro
Black PVC
PVC noir

3036

4043

● Negro texturado RAL 9005
Textured black RAL 9005
Noir texturé RAL 9005

● PVC negro
Black PVC
PVC noir

Milos

Luxcambra Team

La intención de esta colección es crear un producto de máxima simplicidad representada con un cuerpo cilíndrico suspendido con una luz directa hacia abajo perfecta.

The intention of this collection is to create a product of maximum simplicity represented by a cylindrical body diffusing the perfect direct downward LED light.

L'intention de cette collection est de créer un produit d'une simplicité maximale, représentée par un corps cylindrique diffusant une lumière LED directe parfaite.

Familia / Family / Famille

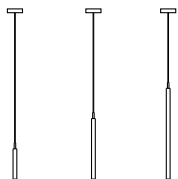





Milos

Estructura en blanco, negro o color RAL. Cable de PVC negro.

White, black or RAL color structure. Black PVC cable.



LED 3W
150 lm / 2.700K

Structure en blanc, noir ou couleur RAL. Câble PVC noir.



BIM/3D files: luxcambra.com/3D (3ds, dwg, 3dm, skp, rfa)

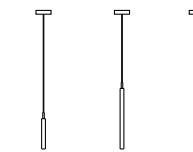
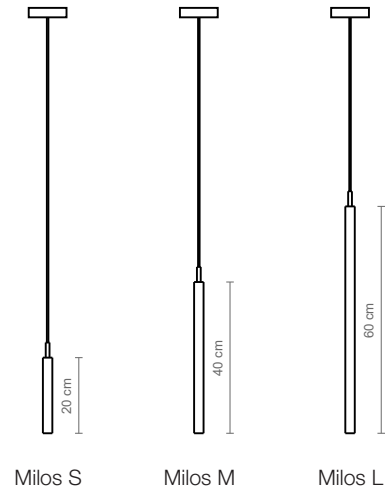

1293 1298 1303

1291 1296 1301

1295 1300 1305

ESTRUCTURA
STRUCTURE
STRUCTURE

CABLE
CABLE
CÂBLE

● Blanco mate texturado RAL 9016
Textured matt white RAL 9016
Blanc mat texturé RAL 9016

● PVC negro
Black PVC
PVC noir

● Negro texturado RAL 9005
Textured black RAL 9005
Noir texturé RAL 9005

● PVC negro
Black PVC
PVC noir

○ Color RAL
RAL color
Couleur RAL

○ PVC negro
Black PVC
PVC noir

Miramar

Jordi Llopis

Las lámparas de suspensión Miramar con sus formas redondeadas se inspiran formalmente en los faros de señalización luminosa del litoral marítimo. La serie está formada por dos pantallas de distintos diámetros que comparten una estructura cilíndrica de soporte. Cada luminaria se obtiene de las distintas combinaciones de medidas y acabados, obteniendo así un resultado personalizado para cada ambiente. Tanto el cilindro como la pantalla de estilo minimalista son de aluminio y pueden ser en negro, blanco y aluminio pulido.

The Miramar hanging lamps with their rounded-shaped form are inspired by signaling lighthouses on the Spanish sea coast. The series is made up of two shapes of different diameters sharing a cylindrical support structure. Each lamp is obtained from the different combinations of sizes and finishes, and thus allow to obtain a personalized result for each environment. Both the cylinder and the minimalist style shade are made of aluminum and can be in black, white or polished aluminum.

Les suspensions Miramar aux formes arrondies s'inspirent par la forme des phares de signalisation lumineuse du littoral espagnol. Cette série est composée de deux abat-jours de diamètres différents partageant une structure de support cylindrique. Chaque luminaire est obtenu à partir des différentes combinaisons de mesures et de finitions, obtenant ainsi un résultat personnalisé pour chaque environnement. Le cylindre et l'abat-jour au style minimaliste sont en aluminium et peuvent être en finition noire, blanche ou aluminium poli.

Familia / Family / Famille

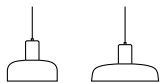





Las dos piezas que componen la lámpara son intercambiables y permiten a partir de distintos acabados personalizarla.

The two pieces composing the lamp are interchangeable and allow you to customize it with different finishes.

Les deux pièces qui composent la lampe sont interchangeables et vous permettent de la personnaliser avec différentes finitions.





Miramar

Cilindro y pantalla metálica en blanco, negro o aluminio pulido brillante. Cable eléctrico de PVC negro. Florón negro.

Metallic cylinder and lampshade in black, white or polished aluminium. Black electrical PVC cable. Black ceiling support.

Abat-jour et cylindre métallique en blanc, noir ou aluminium poli brillant. Câble électrique PVC noir. Support noir.



E-27 LED 12W



BIM/3D files: luxcambra.com/3D (3ds, dwg, 3dm, skp, rfa)

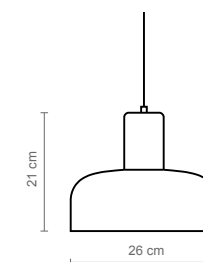

Miramar S

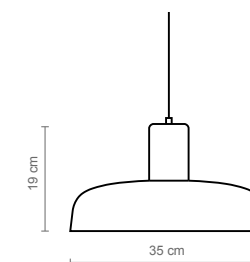

Miramar L



1790

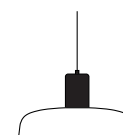

1791

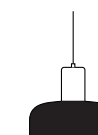

1792

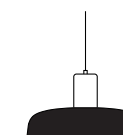

1793



1794



1795



1796



1797



1798



1799



1800



1801

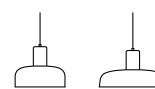

1691



1695

ESTRUCTURA STRUCTURE STRUCTURE

● Blanco roto texturado RAL 9002
Textured off-white RAL 9002
Blanc cassé texturé RAL 9002

● Negro texturado RAL 9005
Textured black RAL 9005
Noir texturé RAL 9005

● Aluminio pulido brillante
Polished aluminium
Aluminium poli brillant

PANTALLA LAMP SHADE ABAT-JOUR

● Blanco roto texturado RAL 9002
Textured off-white RAL 9002
Blanc cassé texturé RAL 9002

● Negro texturado RAL 9005
Textured black RAL 9005
Noir texturé RAL 9005

● Aluminio pulido brillante
Polished aluminium
Aluminium poli brillant

CABLE CABLE CÂBLE

● PVC negro
Black PVC
PVC noir

● PVC negro
Black PVC
PVC noir

● PVC negro
Black PVC
PVC noir

Moon

Luxcambra Team

La colección Moon con su globo de cristal inspirado en el diseño vintage se fabrica en dos formatos y en diferentes medidas y acabados. Se trata de una pieza muy versátil y apropiada tanto para uso doméstico como para proyectos de restauración.

The Moon collection with its glass globe inspired by vintage design is manufactured in two formats and in different sizes and finishes. It is a very versatile piece suitable for both private homes and renovation projects.

La collection Moon avec son globe en verre inspiré du design vintage est fabriquée en deux formats et en différentes tailles et finitions. C'est une pièce très polyvalente adaptée à la fois à un usage privé et à des projets de rénovation.

Familia / Family / Famille

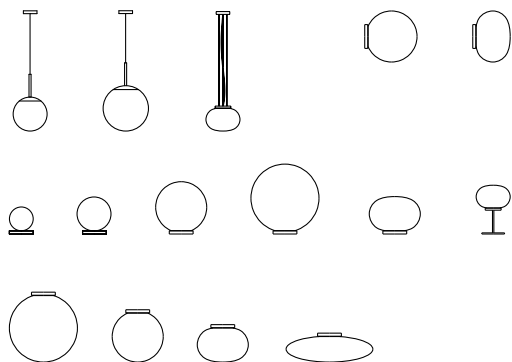







Moon a / Moon pl

Estructura en blanco, negro o dorado. Globo opal triplex.

White, black or gold structure. Globe opal triplex.

Structure en blanc, noir ou doré. Globe opal triplex.



E-27 LED 12W
(Moon a)
(Moon pl 1 / 2)



2 x E-27 LED 12W
(Moon pl 3)



BIM/3D files: luxcambra.com/3D (3ds, dwg, 3dm, skp, rfa)

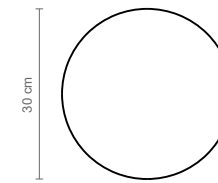

Moon a 1

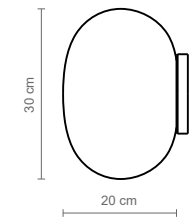

Moon a 2

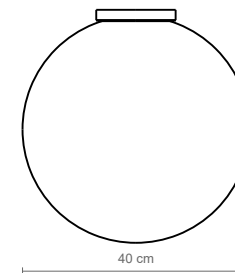

Moon pl 1 40

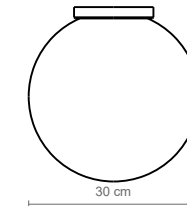

Moon pl 1 30

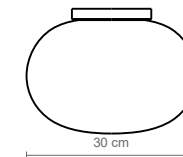

Moon pl 2

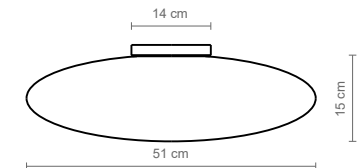

Moon pl 3



1262



1266



1270



1274



2161



2169

FLORÓN
CEILING SUPPORT
SUPPORT PLAFOND

● Blanco mate
Matt white | Blanc mat

● Negro texturado
Textured black | Noir texturé

● Dorado satinado
Satin gold | Doré satiné

1263

1267

1271

1275

2162

2170

1492

1493

1494

1495

2576

2578

Moon c

Estructura en blanco, negro o dorado. Globo opal triplex. Cable eléctrico de algodón negro.

White, black or gold structure. Globe opal triplex. Black electrical cotton cable.

Structure en blanc, noir ou doré. Globe opal triplex. Câble électrique de coton noir.



E-27 LED 12W



BIM/3D files: luxcambra.com/3D (3ds, dwg, 3dm, skp, rfa)

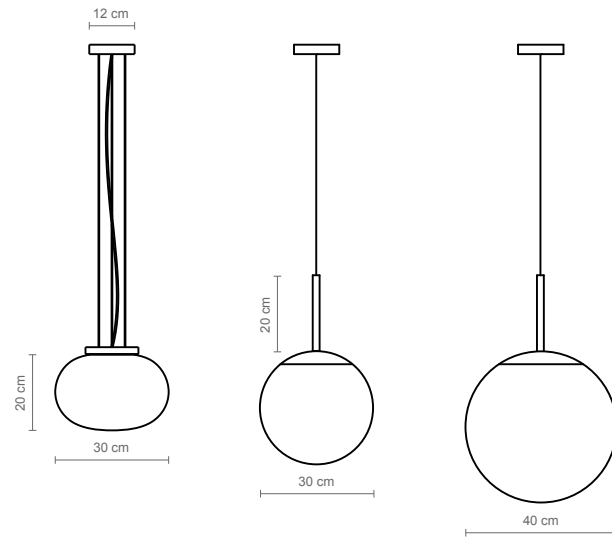

Moon c 2

Moon c 1 30

Moon c 1 40

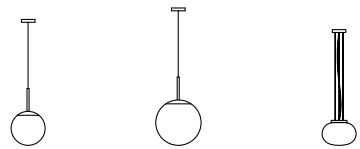

1250 1254 1258

1251 1255 1259

1489 1490 1491

FLORÓN Y ESTRUCTURA
CEILING SUPPORT AND STRUCTURE
SUPPORT PLAFOND ET STRUCTURE

● Blanco mate
Matt white | Blanc mat

● Negro texturado
Textured black | Noir texturé

● Dorado satinado
Satin gold | Doré satiné

Moon s

Estructura en blanco, negro o dorado. Globo opal triplex. Cable eléctrico de PVC negro.

White, black or gold structure. Globe opal triplex. Black electrical PVC cable.

Structure en blanc, noir ou doré. Globe opal triplex. Câble électrique PVC noir.



E-14 LED 12W
(Moon s 1 14)
(Moon s 1 20)



2 x E-27 LED 12W
(Moon s 1 30/40)
(Moon s 2)



BIM/3D files: luxcambra.com/3D (3ds, dwg, 3dm, skp, rfa)

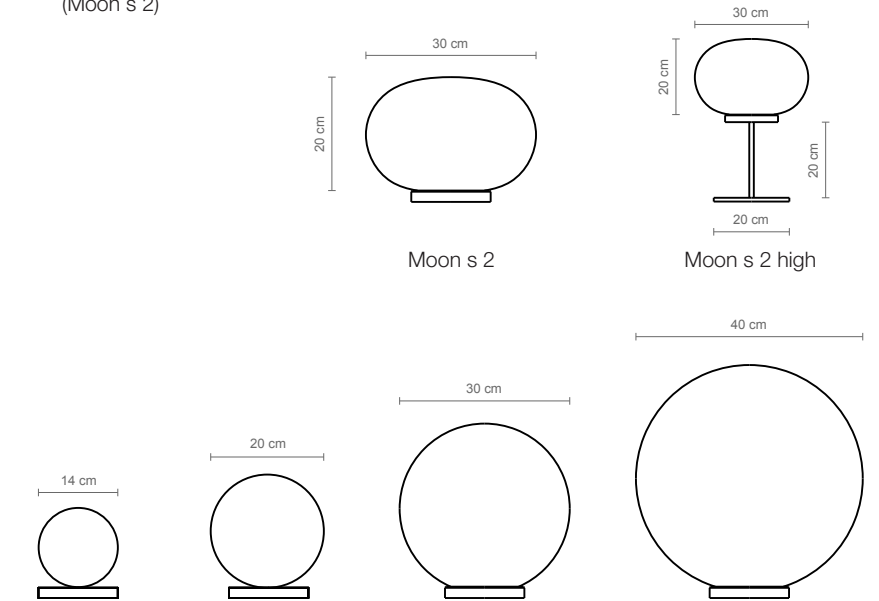

Moon s 1 14

Moon s 1 20

Moon s 1 30

Moon s 1 40

Moon s 2

Moon s 2 high

3168 3172 3038 3042 3046 3179

3169 3173 3039 3043 3047 3180

3170 3174 3176 3177 3178 3181

ESTRUCTURA
STRUCTURE
STRUCTURE

● Blanco mate
Matt white | Blanc mat

● Negro texturado
Textured black | Noir texturé

● Dorado satinado
Satin gold | Doré satiné

Nautic

Luxcambra Team

La colección Nautic es un clásico de nuestro catálogo. Sus lámparas están pensadas para aportar calidez y crear atmósferas llenas de matices mediante los diferentes materiales de sus pantallas. Su luz de ambiente humaniza y dota de personalidad cualquier espacio.

The Nautic collection is a classic range in our catalogue. Its lamps are designed to provide warmth by creating nuanced atmospheres through the different materials of its shades. Its ambient light humanizes and gives some personality to any type of space.

La collection Nautic est une gamme classique de notre catalogue. Ses lampes sont conçues pour apporter de la chaleur et créer des atmosphères nuancées à travers les différents matériaux de ses abat-jours. Sa lumière ambiante humanise l'espace en lui donnant une personnalité particulière.

Familia / Family / Famille

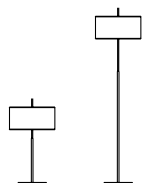



Nautic s / Nautic p

Estructura en níquel, blanco o negro. Pantalla de loneta, osaka, arpillera o cotonet. Cable eléctrico de PVC negro o transparente.

Nickel, white, black structure. Cotton, osaka, sackling or cotonet lampshade. Black or transparent électrique de PVC cable.

Structure en nickel, blanc ou noir. Abat-jour en coton, osaka, jute ou cotonet. Câble électrique PVC noir ou transparent.



2 x E-27 LED



BIM/3D files: luxcambra.com/3D (3ds, dwg, 3dm, skp, rfa)

		ESTRUCTURA STRUCTURE STRUCTURE		PANTALLA LAMP SHADE ABAT-JOUR		CABLE CABLE CÂBLE	
3064	4094		Níquel Nickel Nickel		Loneta blanca White cotton Coton blanc		Transparente Transparent Transparent
3065	4095		Níquel Nickel Nickel		Osaka Osaka Osaka		Transparente Transparent Transparent
3067	4097		Níquel Nickel Nickel		Cotonet blanco White cotonet Cotonet blanc		Transparente Transparent Transparent
3073	4103		Negro RAL 9005 Black RAL 9005 Noir RAL 9005		Cotonet negro Black cotonet Cotonet noir		PVC negro Black PVC PVC noir
3074	4104		Negro RAL 9005 Black RAL 9005 Noir RAL 9005		Cotonet antracita Anthracite cotonet Cot. anthracite		PVC negro Black PVC PVC noir
3075	4105		Negro RAL 9005 Black RAL 9005 Noir RAL 9005		Loneta blanca White cotton Coton blanc		PVC negro Black PVC PVC noir
3076	4106		Negro RAL 9005 Black RAL 9005 Noir RAL 9005		Osaka Osaka Osaka		PVC negro Black PVC PVC noir
3078	4108		Blanco RAL 9016 White RAL 9016 Blanc RAL 9016		Cotonet blanco White cotonet Cotonet blanc		Transparente Transparent Transparent

Niuet

Xavier Solé

NIUET es un ejercicio de síntesis que reproduce las estructuras complejas de los nidos de los pájaros más pequeños, aquellos que son descendientes directos de la vida que habitó en la tierra hace millones de años. Fabricada artesanalmente en material mimbre y trenzada a mano por maestros cesteros de Girona, esta colección cumple con los requisitos máximos de calidad. La luz del interior que ilumina su arquitectura nos recuerda que el ciclo de la naturaleza continua y debemos cuidarla.

NIUET is an exercise of recreation of the complex structures of small bird nests, which are direct descendants from the development of life millions of years ago. Manufactured out of wicker by handicraft suppliers from Girona, this collection complies with all quality requirements. Its bright light coming from the center is a metaphor of the continuous cycle of life, which must be preserved.

NIUET est un exercice de synthèse qui cherche à reproduire la structure complexe des nids de perroquets de petite taille, une espèce descendante directe de la vie qui s'est développée sur Terre il y a des millions d'années. Fabriquée artisanalement en osier et tressée à la main par des vanniers à Gérone, cette collection remplit toutes les exigences de qualité. Sa source de lumière provenant du centre de la lampe est une métaphore de la vie en continuelle évolution au cours des siècles, qui doit être préservée.



Lámpara seleccionada por el Trend Forum Light+Building 2020 por su diseño orgánico y uso de materiales naturales.

Lamp selected for the Trend Forum Light+Building 2020 for its organic design and fabrication from natural fibres.

Lampe sélectionnée par le « Trend Forum » Light+Building 2020 pour son design organique et l'utilisation de matériaux naturels.

Familia / Family / Famille

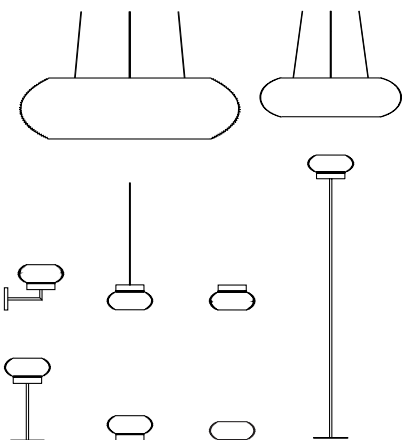



Las pantallas están tejidas a mano con mimbre natural. Sus ramas delgadas, largas y flexibles permiten darles la forma deseada.

The lampshades are handwoven with natural wicker. Its thin, long and flexible branches allow to give them the desired shape.

Les abat-jour sont tissés à la main avec de l'osier naturel. Ses branches fines, longues et souples permettent de lui donner la forme souhaitée.









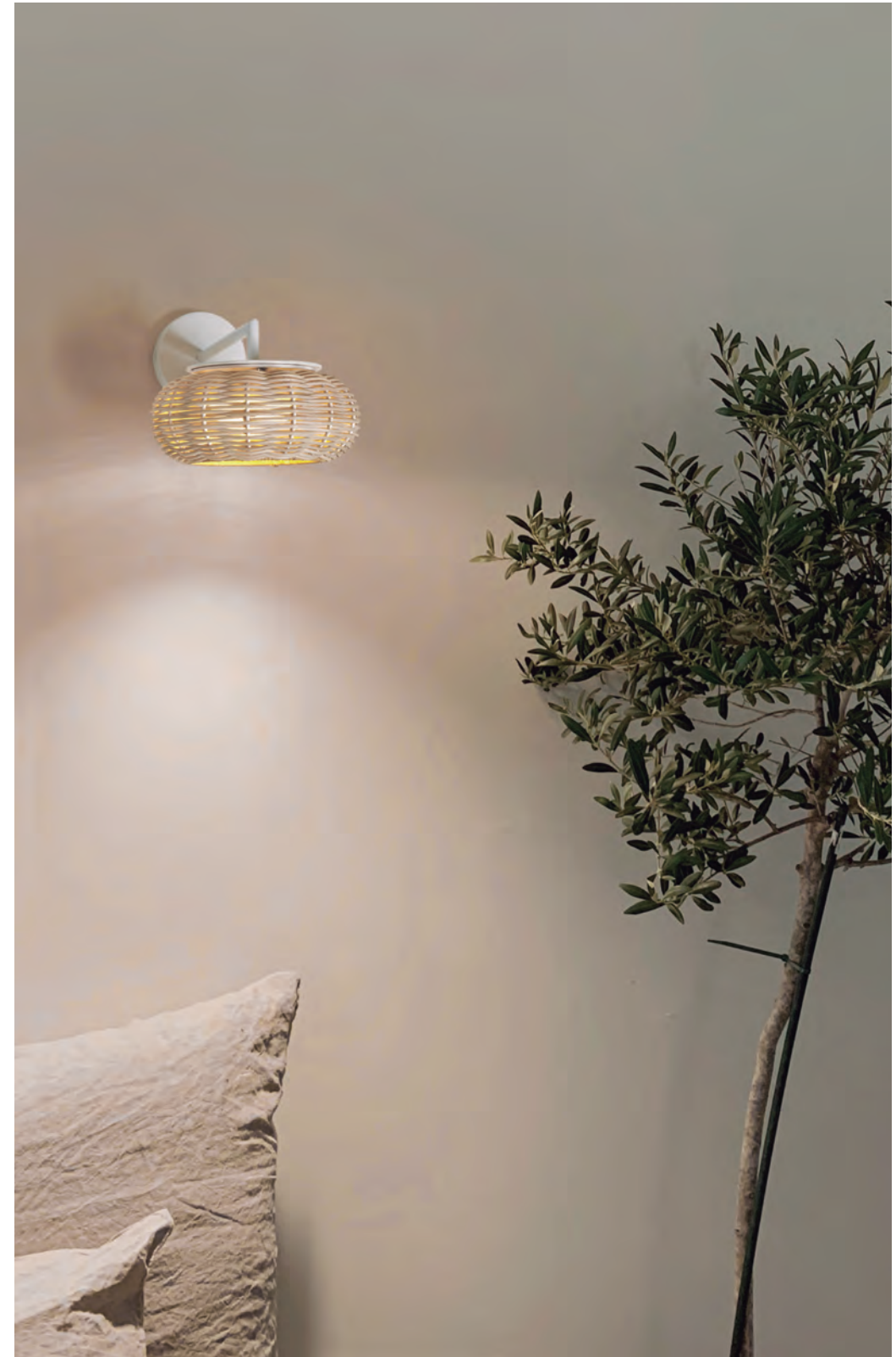



Niuet a / Niuet pl

Estructura en blanco. Pantalla de mimbre natural trenzado a mano.

White structure. Handmade shade of natural wicker.

Structure en blanc. Abat-jour en osier naturel fait à la main.



GX-53 LED 8W
670 lm / 2.700 K



BIM/3D files: luxcambra.com/3D (3ds, dwg, 3dm, skp, rfa)

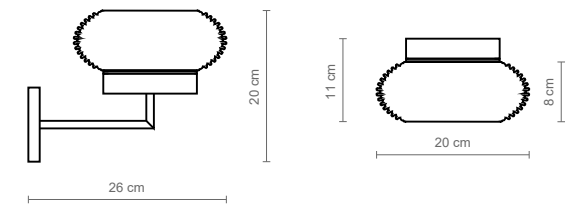

Niuet a

Niuet pl



2393



1346

ESTRUCTURA
STRUCTURE
STRUCTURE

Blanco RAL 9016
White RAL 9016
Blanc RAL 9016

PANTALLA
LAMP SHADE
ABAT-JOUR

Mimbre natural
Natural wicker
Osier naturel

CARACTERÍSTICAS ELÉCTRICAS
ELECTRICAL CHARACTERISTICS
CARACTÉRISTIQUES ÉLECTRIQUES

Bombilla GX-53 LED 8W
GX-53 LED 8W bulb
Ampoule GX-53 LED 8W



Niuet c

Estructura en blanco. Pantalla de mimbre natural trenzado a mano. Cable eléctrico de algodón blanco.

White structure. Handmade shade of natural wicker. White electrical cotton cable.

Structure en blanc. Abat-jour en osier naturel fait à la main. Câble électrique de coton blanc.

BIM/3D files: luxcambra.com/3D (3ds, dwg, 3dm, skp, rfa)

-  GS-53 LED 8W
670 lm / 2.700 K
(Niuet c S)
-  PCB 93 LEDS 22W
1.700 lm / 3.000 K
(Niuet c M)
-  PCB 155 LEDS 40W
3.250 lm / 3.000 K
(Niuet c L)

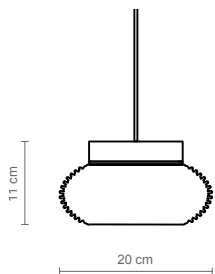

Niuet c S

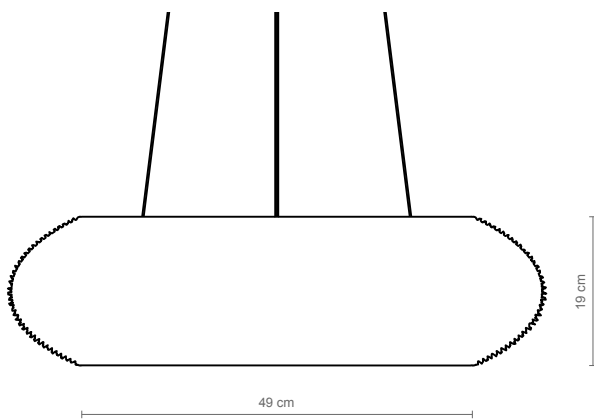

Niuet c L

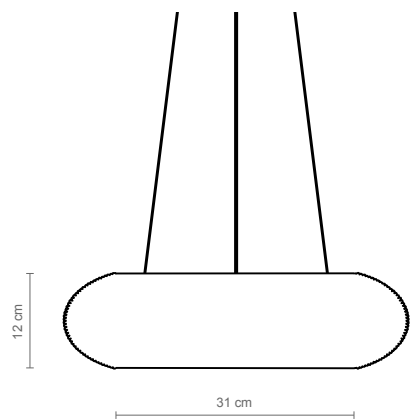

Niuet c M



	ESTRUCTURA STRUCTURE STRUCTURE	PANTALLA LAMP SHADE ABAT-JOUR	CARACTERÍSTICAS ELÉCTRICAS ELECTRICAL CHARACTERISTICS CARACTÉRISTIQUES ÉLECTRIQUES
	1348	● Blanco RAL 9016 White RAL 9016 Blanc RAL 9016	■ Mimbre natural Natural wicker Osier naturel
	1350	● Blanco RAL 9016 White RAL 9016 Blanc RAL 9016	■ Mimbre natural Natural wicker Osier naturel
	1351	● Blanco RAL 9016 White RAL 9016 Blanc RAL 9016	■ Mimbre natural Natural wicker Osier naturel

Niuet s / Niuet s high / Niuet s portátil / Niuet p

Estructura en blanco. Pantalla de mimbre natural trenzado a mano. Cable transparente. El modelo portátil sin conexión a red funciona con fuente de luz LED IP67 con batería recargable por sistema de inducción. 6h duración a máxima potencia.

White structure. Handmade shade of natural wicker. White cotton cable. The portable wireless version is powered by a LED light source IP67 with rechargeable battery by induction system. 6h of battery life at maximum power.

Structure en blanc. Abat-jour en osier naturel fait à la main. Câble de coton blanc. Le modèle portable sans câble fonctionne grâce à une source de lumière LED IP67 avec batterie rechargeable par système d'induction. 6h d'autonomie à puissance maximale.

-  GS-53 LED 8W
670 lm / 2.700 K
(Niuet s, Niuet s high)
(Niuet p)
-  290 lm / 3.000K
(Niuet s portátil)

BIM/3D files: luxcambra.com/3D (3ds, dwg, 3dm, skp, rfa)

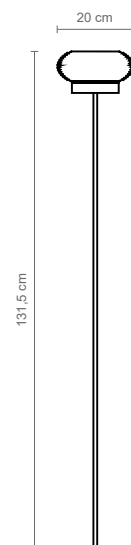

Niuet p

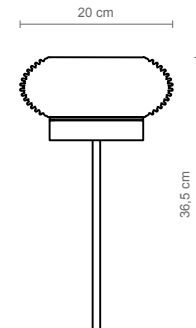

Niuet s high

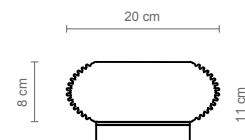

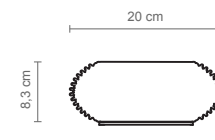

Niuet s



Niuet s portátil



	ESTRUCTURA STRUCTURE STRUCTURE	PANTALLA LAMP SHADE ABAT-JOUR	CARACTERÍSTICAS ELÉCTRICAS ELECTRICAL CHARACTERISTICS CARACTÉRISTIQUES ÉLECTRIQUES
	3150	● Blanco RAL 9016 White RAL 9016 Blanc RAL 9016	■ Mimbre natural Natural wicker Osier naturel
	2395	● Blanco RAL 9016 White RAL 9016 Blanc RAL 9016	■ Mimbre natural Natural wicker Osier naturel
	3152	● Blanco RAL 9016 White RAL 9016 Blanc RAL 9016	■ Mimbre natural Natural wicker Osier naturel
	4172	● Blanco RAL 9016 White RAL 9016 Blanc RAL 9016	■ Mimbre natural Natural wicker Osier naturel

Oita

Xavier Solé

Oita es una lámpara clásica de pantalla ovalada, con lector incorporado en su base, de reducidas dimensiones. Su forma básica y elegante permite ubicarse indistintamente en habitaciones de Hoteles o en el hogar.

Oita is a classic wall lamp with oval shade and integrated LED reader in the small wall support. Its elegant shape is ideal for the hotel industry as well as for domestic use.

Oita est une applique classique avec un abat-jour oval et un lecteur LED intégré sur une petite structure murale. Sa forme élégante est idéale pour le secteur hôtelier tout comme pour le secteur résidentiel.

Familia / Family / Famille







Oita / Oita lector

Estructura en blanco o negro. Pantalla de cotonet o screen.

White or black structure. Cotonet or screen lampshade.

Structure en blanc ou noir. Abat-jour en cotonet ou screen.



E-27 LED 12W



LED 3W
150 lm / 2.700K



BIM/3D files: luxcambra.com/3D (3ds, dwg, 3dm, skp, rfa)

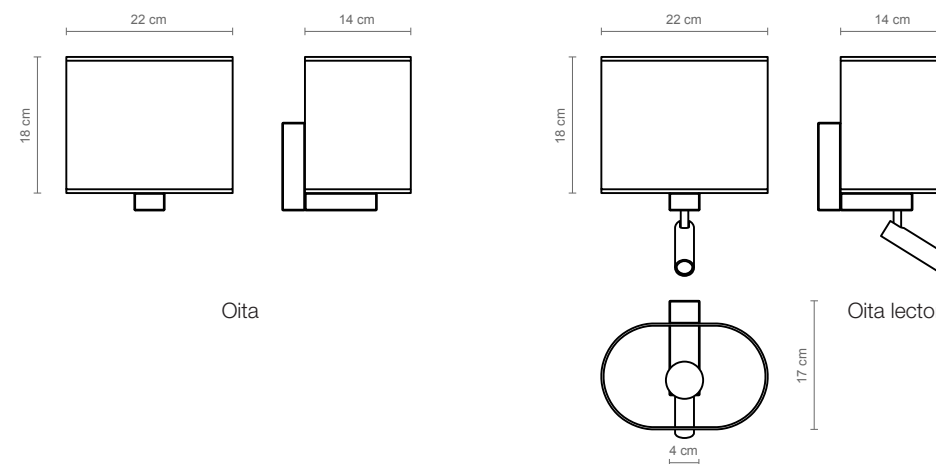

ESTRUCTURA
STRUCTURE
STRUCTURE

PANTALLA
LAMP SHADE
ABAT-JOUR

2415	2421	● Negro RAL 9005 Black RAL 9005 Noir RAL 9005	■ Screen negro Black screen Screen noir
2416	2422	● Negro RAL 9005 Black RAL 9005 Noir RAL 9005	■ Screen blanco White screen Screen blanc
2417	2423	● Negro RAL 9005 Black RAL 9005 Noir RAL 9005	■ Screen beige Beige screen Screen beige
2418	2424	● Negro RAL 9005 Black RAL 9005 Noir RAL 9005	■ Cotonet blanco White cotonet Cotonet blanc
2419	2425	● Negro RAL 9005 Black RAL 9005 Noir RAL 9005	■ Cotonet sand Sand cotonet Cotonet sand
2420	2426	● Negro RAL 9005 Black RAL 9005 Noir RAL 9005	■ Cotonet negro Black cotonet Cotonet noir
2427	2433	● Blanco RAL 9016 White RAL 9016 Blanc RAL 9016	■ Screen negro Black screen Screen noir
2428	2434	● Blanco RAL 9016 White RAL 9016 Blanc RAL 9016	■ Screen blanco White screen Screen blanc
2429	2435	● Blanco RAL 9016 White RAL 9016 Blanc RAL 9016	■ Screen beige Beige screen Screen beige
2430	2436	● Blanco RAL 9016 White RAL 9016 Blanc RAL 9016	■ Cotonet blanco White cotonet Cotonet blanc
2431	2437	● Blanco RAL 9016 White RAL 9016 Blanc RAL 9016	■ Cotonet sand Sand cotonet Cotonet sand
2432	2438	● Blanco RAL 9016 White RAL 9016 Blanc RAL 9016	■ Cotonet negro Black cotonet Cotonet noir

Oxygen

Bruno de Ávila

Oxygen es una colección inspirada en la naturaleza y pensada para dar un soplo de aire fresco a nuestro entorno.

Los seres humanos y las plantas necesitamos la luz de distintas formas, por ello hemos creado en esta colección una sinergia entre naturaleza e iluminación artificial. Durante el día, la lámpara Oxygen puede llegar a ser un elemento decorativo. Por la noche, las luces indirectas y enfocadas resaltan la textura de la planta y aportan calidez al entorno. La colección está disponible en negro, blanco y ocre tierra.

The Oxygen collection is inspired by nature and it was designed to give a breath of fresh air to our surroundings.

Humans and plants need light in different ways, which is why we created a synergy between nature and artificial lighting. During the day, the Oxygen lamp is a decorative piece. At night, both indirect and focused lights are there to highlight the texture of the plant and to bring some warmth to the space. The collection is available in black, white or earthy ocher finishes.

Oxygen est une collection inspirée par la nature et conçue pour donner une bouffée d'air frais à notre environnement.

Les êtres humains et les plantes ont besoin de lumière de façon différente, c'est pourquoi nous avons créé une synergie entre la nature et l'éclairage artificiel. Pendant la journée, le luminaire est un élément décoratif. La nuit, les lumières indirectes et focalisées sont là pour mettre en valeur la texture de la plante et apporter de la chaleur à l'espace. La collection est disponible en finition noire, blanche ou terre ocre.



archiproducts
DESIGN AWARDS
—
LONGLISTED 2021

Familia / Family / Famille

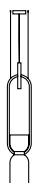







Oxygen c / Oxygen s

Estructura en blanco o negro. Disponible con maceta autorriego. Cable eléctrico de PVC negro.

White or black structure. Available with self-watering pot. Black electrical PVC cable.

Structure en blanc ou noir. Disponible avec pot auto-arrosant. Câble électrique PVC noir.



E-27 LED 12W



LED 3W
150 lm / 2.700K



BIM/3D files: luxcambr.com/3D (3ds, dwg, 3dm, skp, rfa)

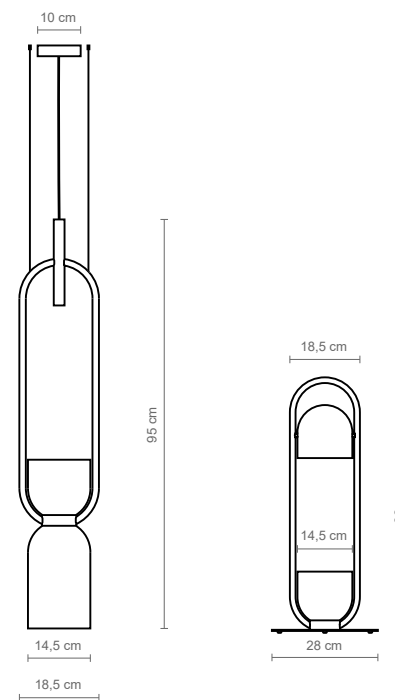

Oxygen c

Oxygen s



1531



3208

FLORÓN Y ESTRUCTURA
CEILING SUPPORT AND STRUCTURE
SUPPORT PLAFOND ET STRUCTURE

● Negro texturado RAL 9005
Textured black RAL 9005
Noir texturé RAL 9005

1532

3209

● Blanco roto texturado RAL 9002
Textured off-white RAL 9002
Blanc cassé texturé RAL 9002

Panama

Luxcambra Team

Este funcional aplique ofrece dos puntos de luz al mismo tiempo. Una luz de ambiente indirecta y cálida para el dormitorio y un potente foco lector flexible que puede dirigirse hacia cualquier dirección. Se trata de un aplique muy versátil y apropiada tanto para uso doméstico como para proyectos de iluminación para habitaciones de hotel. Puede incluir un puerto de carga USB.

This functional wall lamp offers two points of light at the same time. A warm, indirect ambient light for the bedroom and a powerful flexible led reader that can be directed in any direction. It is a very versatile wall lamp that is suitable for both domestic use and for lighting projects in hotel rooms. It can include a USB charging port.

Cette applique fonctionnelle offre deux points de lumière en même temps. Une lumière d'ambiance chaude et indirecte pour la chambre et une puissante liseuse flexible qui peut être orientée dans toutes les directions. C'est une applique très polyvalente qui convient à la fois à un usage domestique et aux projets d'éclairage de chambres d'hôtel. Elle peut inclure un port de charge USB.





Panama

Estructura en blanco o negro.

White or black structure.

Structure en blanc ou noir.



E-27 LED 12W



LED 3W
150 lm / 2.700K



BIM/3D files: luxcambra.com/3D (3ds, dwg, 3dm, skp, rfa)

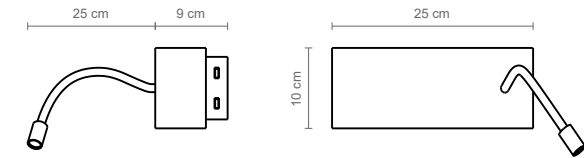

ESTRUCTURA
STRUCTURE
STRUCTURE

2016

● Negro texturado RAL 9005
Textured black RAL 9005
Noir texturé RAL 9005

2015

● Blanco mate texturado RAL 9016
Textured matt white RAL 9016
Blanc texturé mat RAL 9016

Parabolica

Joan Antoni Blanc 1973

La lámpara de suspensión “Parabólica”, selección de los premios ADI-FAD del año 1973, fue diseñada por Joan Antoni Blanc con la intención de conseguir una pantalla con la geometría idónea para proyectar la luz de manera eficiente. La parábola es la forma más favorable para este fin, siempre que el foco de luz interior esté correctamente ubicado; condicionante que obliga a generar un espacio superior para su incorporación. La fusión de estos dos conceptos configura la silueta de la “Parabólica”.



Selección Premio Delta ADI-FAD, 1973.

Selection Delta Award ADI-FAD, 1973.

Sélection Prix Delta ADI-FAD, 1973.

The “Parabólica” hanging lamp, selected for the ADI-FAD awards in 1973, was designed by Joan Antoni Blanc with the intention of achieving a lampshade with an ideal geometry to project light efficiently. The parabola is the most favorable manner for this purpose, as long as the interior light source is correctly located; which is a condition that forces to create a superior space for its incorporation. The fusion of these two concepts configures the silhouette of the “Parabólica”.

La suspensión “Parabólica”, sélectionnée pour les prix ADI-FAD en 1973, a été conçue par Joan Antoni Blanc avec l'intention de réaliser un abat-jour avec une géométrie idéale pour projeter la lumière efficacement. La parabole est la voie la plus favorable pour cet effet, à condition que la source lumineuse à l'intérieur soit correctement localisée ; ce qui oblige à créer un espace supérieur pour son incorporation. La fusion de ces deux concepts génère la silhouette de la “Parabólica”.



Parabolica 70s







Las perforaciones de la parte superior permiten, cuando la lámpara está encendida, generar distintos matices y efectos de luz a la propia pantalla.

The perforations in the upper part allow to generate different nuances and light effects on the lampshade itself, when the lamp is switched on.

Les perforations sur la partie supérieure permettent, lorsque la lampe est allumée, de générer différentes nuances et effets de lumière sur l'abat-jour directement.

Parabolica

Estructura en blanco, negro, mostaza o aluminio.
Cable eléctrico de PVC negro.

White, black, mustard or aluminium structure.
Black electrical PVC cable.

Structure en blanc, noir, moutarde ou aluminium. Câble électrique PVC noir.



E-27 LED 12W



BIM/3D files: luxcambra.com/3D (3ds, dwg, 3dm, skp, rfa)

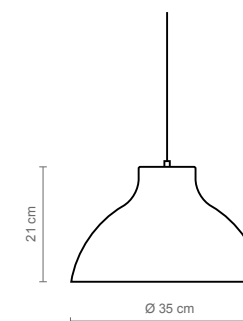

	FLORÓN CEILING SUPPORT SUPPORT PLAFOND	ESTRUCTURA STRUCTURE STRUCTURE	CABLE CABLE CÂBLE
1699	● Blanco mate Textured white <i>Blanc mat</i>	● Blanco mate texturado RAL 9016 Textured matt white RAL 9016 <i>Blanc texturé mat RAL 9016</i>	● PVC negro Black PVC <i>PVC noir</i>
1700	● Negro texturado Textured black <i>Noir texturé</i>	● Negro texturado RAL 9005 Textured black RAL 9005 <i>Noir texturé RAL 9005</i>	● PVC negro Black PVC <i>PVC noir</i>
1701	● Mostaza RAL 1004 Mustard RAL 1004 <i>Moutarde RAL 1004</i>	● Mostaza RAL 1004 Mustard RAL 1004 <i>Moutarde RAL 1004</i>	● PVC negro Black PVC <i>PVC noir</i>
1702	● Negro texturado Textured black <i>Noir texturé</i>	● Aluminio pulido brillante Polished aluminium <i>Aluminium poli brillant</i>	● PVC negro Black PVC <i>PVC noir</i>

Raval

Jordi Llopis

La lámpara de suspensión Raval con su campana metálica inspirada en el diseño industrial se presenta en color blanco o negro. Estas pantallas quedan suspendidas de forma elegante creando ambientes cálidos a su alrededor. Resulta especialmente adecuada en proyectos de restauración, cocinas o espacios de trabajo ya sea de forma individual o seriada, con bombilla globo opal.

The Raval hanging lamp with its metallic shade inspired by industrial design is available in black or white. These lampshades are elegantly suspended and create warm environments around them. There are particularly suitable for restoration projects, kitchens or work spaces, either individually or in series, with an opal globe bulb.

La suspension Raval dont la forme métallique est inspirée du design industriel se décline en noir ou blanc. Ces abat-jours sont élégamment suspendus, créant des environnements chaleureux aux alentours. Elle est particulièrement adaptée pour les projets de restauration, les cuisines ou les espaces de travail, que ce soit individuellement ou en séries, avec une ampoule globe opale.





Raval

Estructura en blanco o negro. Cable eléctrico de PVC negro.

White or black structure. Black electrical PVC cable.

Structure en blanc ou noir. Câble électrique de PVC noir.







E-27 Globo LED 12W

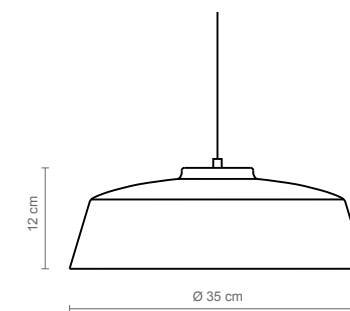

BIM/3D files: luxcambra.com/3D (3ds, dwg, 3dm, skp, rfa)



	FLORÓN CEILING SUPPORT SUPPORT PLAFOND	ESTRUCTURA STRUCTURE STRUCTURE	CABLE CABLE CÂBLE
1703	 Blanco roto Off-white <i>Blanc cassé</i>	 Blanco roto texturado RAL 9002 Textured off-white RAL 9002 <i>Blanc cassé texturé mat RAL 9005</i>	PVC negro Black PVC <i>PVC noir</i>
1704	 Negro texturado Textured black <i>Noir texturé</i>	 Negro texturado RAL 9005 Textured black RAL 9005 <i>Noir texturé RAL 9005</i>	PVC negro Black PVC <i>PVC noir</i>

Rondo

Luxcambra Team

Los plafones Rondo destacan por la variedad de materiales de sus pantallas. Cada uno de ellos aporta una personalidad y una luz diferente, cálida y rica en matices. Cada uno de los materiales humaniza y da carácter al espacio con su sola presencia.

Pensando en su uso para lugares públicos, ofrecemos la posibilidad de fabricarla en grandes formatos.

The Rondo ceiling lamps stand out for the variety of materials available for its shades. Each of them creates a different personality by bringing different warm and nuanced light effects. Each one of the materials humanizes and gives character to the space by itself. As its design was thought to be used in public spaces, we offer the possibility of manufacturing them in large sizes.

Les plafonniers Rondo se distinguent par la variété de matériaux disponibles pour les abat-jours. Chacune finition apporte une personnalité et une lumière chaleureuse et riche en nuances. Chacun des matériaux humanise et donne du caractère à l'espace par sa présence. Comme leur design a été conçu pour les lieux publics, nous offrons également la possibilité de les fabriquer en grands formats.

Familia / Family / Famille

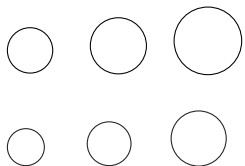





Rondo

Pantalla de lino, rafia, loneta, arpillera, osaka o cotonet. Difusor de pergamino de policarbonato. Sistema de sujeción magnético. Medidas especiales disponibles para proyectos contract (hasta 150 cm).

Linen, raffia, cotton, sacking, osaka or cotonet lampshade. Polycarbonate parchment diffuser. Magnetic clamping system. Special sizes available for contract projects (up to 150 cm).

Abat-jour en lin, en raphia, en coton, en toile, en osaka ou en cotonet. Diffuseur de parchemin en polycarbonate. Système magnétique de serrage. Dimensions spéciales disponibles pour projets contract (jusqu'à 150 cm).



3 x E-27 LED 12W



BIM/3D files: luxcambra.com/3D (3ds, dwg, 3dm, skp, rfa)

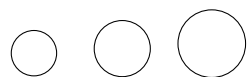
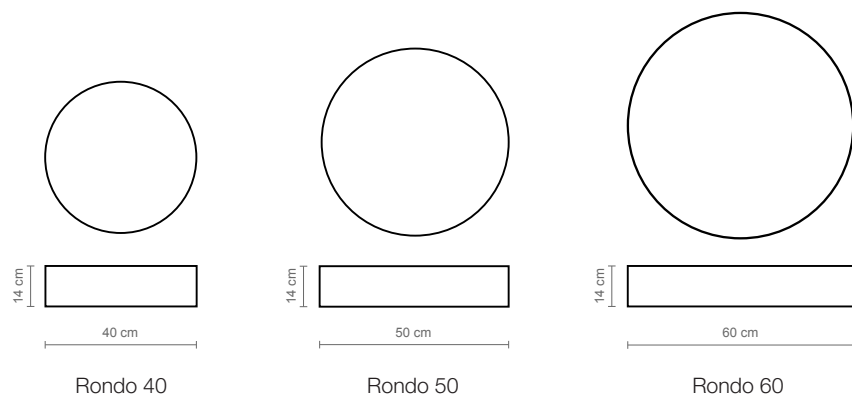

PANTALLA
LAMP SHADE
ABAT-JOUR

DIFUSOR
DIFFUSER
DIFFUSEUR

1536	1539	1542	Lino beige Beige linen <i>Lin beige</i>	Pergamino Parchment <i>Parchemin</i>
1064	1077	1090	Loneta natural <i>Natural cotton</i> <i>Coton naturel</i>	Pergamino Parchment <i>Parchemin</i>
1065	1078	1091	Loneta blanca <i>White cotton</i> <i>Coton blanc</i>	Pergamino Parchment <i>Parchemin</i>
1066	1079	1092	Osaka	Pergamino Parchment <i>Parchemin</i>
1067	1080	1093	Arpillera beige <i>Beige sacking</i> <i>Toile beige</i>	Pergamino Parchment <i>Parchemin</i>
1068	1081	1094	Saco <i>Sack</i> <i>Jute</i>	Pergamino Parchment <i>Parchemin</i>
1070	1083	1096	Arenal topo <i>Taupe arenal</i> <i>Arenal taupe</i>	Pergamino Parchment <i>Parchemin</i>
1071	1084	1097	Cot. arena osc. <i>Dark sand cot.</i> <i>Cot. sable foncé</i>	Pergamino Parchment <i>Parchemin</i>
1072	1085	1098	Cotonet blanco <i>White cotonet</i> <i>Cotonet blanc</i>	Pergamino Parchment <i>Parchemin</i>
1073	1086	1099	Cotonet beige <i>Beige cotonet</i> <i>Cotonet beige</i>	Pergamino Parchment <i>Parchemin</i>
1074	1087	1100	Cotonet negro <i>Black cotonet</i> <i>Cotonet noir</i>	Pergamino Parchment <i>Parchemin</i>
1075	1088	1101	Cot. antracita <i>Anthracite cot.</i> <i>Cot. anthracite</i>	Pergamino Parchment <i>Parchemin</i>
1705	1706	1707	Raffia <i>Raffia</i> <i>Raphia</i>	Pergamino Parchment <i>Parchemin</i>

Rondo wood

Pantalla de madera de roble. Difusor cristal opal.

Oak wood lampshade. Opal glass diffuser.

Abat-jour en bois de chêne. Diffuseur en verre opale.



E-27 LED 12W
(Rondo wood S)



2 x E-27 LED 12W
(Rondo wood M)



BIM/3D files: luxcambra.com/3D (3ds, dwg, 3dm, skp, rfa)



3 x E-27 LED 12W
(Rondo wood L)

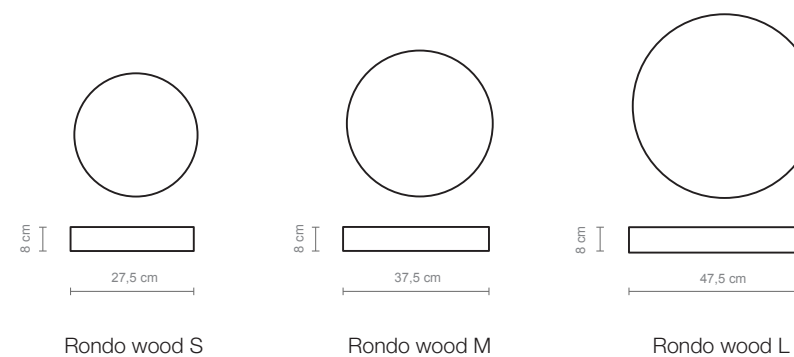

PANTALLA
LAMP SHADE
ABAT-JOUR

DIFUSOR
DIFFUSER
DIFFUSEUR

1545	1547	1549	Madera de roble Oak wood <i>Bois de chêne</i>	Cristal opal Opal glass <i>Verre opale</i>
------	------	------	---	--

Rum

Jordi Llopis

Los apliques Rum quieren aportar calidez, una luz delicada y no protagonista en dormitorios. Pretenden crear un ambiente y al mismo tiempo ser funcionales. Pueden modularse para que se adapten a cualquier dormitorio. Desde la pantalla de algodón integrando o no una mesita y con o sin lector LED, se trata de una colección versátil y adaptable. Además, las versiones del aplique sin repisa pueden orientarse tanto horizontal como verticalmente.

The Rum collection, composed of different wall lamps, brings a warm and delicate light wherever they are located in. They can be ideal for bedrooms as their design creates a specific atmosphere while remaining very functional. Each wall lamp adapts to different rooms. This collection is suitable for any needs because it integrates a textile shade, but also options with or without shelf or even LED reader. The versions without shelf can also be oriented both horizontally and vertically.

Les appliques Rum apportent de la qualité et une lumière délicate. La variété de ces appliques les rend apte à décorer tout type d'espace comme des chambres. Elles sont à la fois créatrices d'ambiance et fonctionnelles. Cette pluralité permet de les adapter à tout type de chambre. Composée d'un abat-jour en coton et intégrant ou non une étagère ou avec/sans lecteur, la collection est ample et très polyvalente. De plus, les versions sans étagère peuvent être fixées aussi bien horizontalement que verticalement.

Familia / Family / Famille

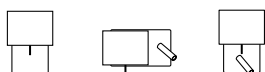





Rum / Rum lector

Estructura en blanco o negro. Pantalla de cotonet.
Con interruptor de tirador.

Structure in white or black. Cotonet lampshade.
With pull switch.

Structure en blanc ou noir. Abat-jour en cotonet. Avec interrupteur cordon.

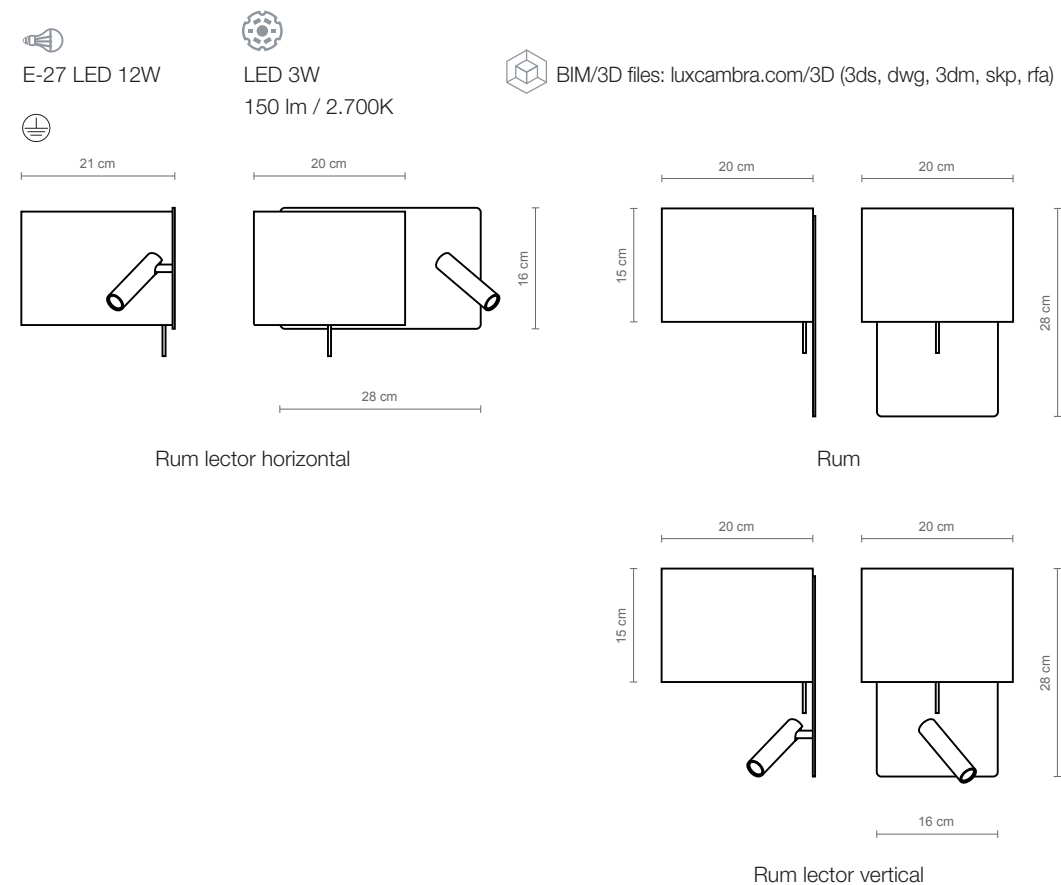

ESTRUCTURA STRUCTURE STRUCTURE			PANTALLA LAMP SHADE ABAT-JOUR	
2451	2403	2871	● Blanco roto texturado Textured off-white <i>Blanc cassé texturé</i>	■ Cotonet gris frío Cold gray cot. <i>Cot. gris froid</i>
2452	2404	2872	● Blanco roto texturado Textured off-white <i>Blanc cassé texturé</i>	■ Cotonet arena oscura Dark sand cot. <i>Cot. sable sombre</i>
2453	2405	2873	● Blanco roto texturado Textured off-white <i>Blanc cassé texturé</i>	■ Cotonet blanco White cotonet <i>Cotonet blanc</i>
2454	2406	2874	● Negro texturado Textured black <i>Noir texturé</i>	■ Cotonet gris frío Cold gray cot. <i>Cot. gris froid</i>
2455	2407	2875	● Negro texturado Textured black <i>Noir texturé</i>	■ Cotonet arena oscura Dark sand cot. <i>Cot. sable sombre</i>
2456	2408	2876	● Negro texturado Textured black <i>Noir texturé</i>	■ Cotonet blanco White cotonet <i>Cotonet blanc</i>

Sarria

Xavier Solé

Xavier Solé, ha querido con este diseño reinterpretar las clásicas lámparas de luz incandescente integrando dos tipologías de lámparas en una sola. Las dimensiones generosas del tubo central permiten tener una imagen estable y segura para ubicarse en espacios Contract. La incorporación de luz led en el interior de la tulipa se refleja sutilmente en el interior de la pantalla, creando un ambiente dual de iluminación.

With this design, Xavier Solé wanted to reinterpret the classic incandescent light lamps by integrating two types of lamps into one. The dimensions of the central tube allow it to have a stable and safe lighting source for the hospitality sector. The incorporation of led light inside the lampshade is subtly reflected inside the lampshade, creating a contrasted lighting environment.

Avec ce design, Xavier Solé a voulu réinterpréter les lampes à incandescence classiques, en intégrant deux types de lampes en une seule. Les dimensions généreuses du tube central permettent de situer une image stable et sûre dans les espaces Contract. L'incorporation de la lumière LED à l'intérieur de l'abat-jour se reflète subtilement à l'intérieur de l'écran, créant un double environnement d'éclairage.

Familia / Family / Famille

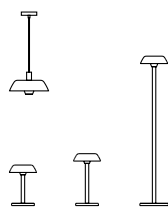









Sarria s / Sarria p

Estructura en blanco, negro o terracota. Pantalla metálica con tulipa de cristal. Cable eléctrico de PVC negro.

Structure in white, black or terracotta. Metallic lampshade with glass disk. Black electrical PVC cable.

Structure en blanc, noir ou terracotta. Abat-jour métallique avec disque en cristal. Câble électrique PVC noir.



E-14 LED 12W



BIM/3D files: luxcambra.com/3D (3ds, dwg, 3dm, skp, rfa)

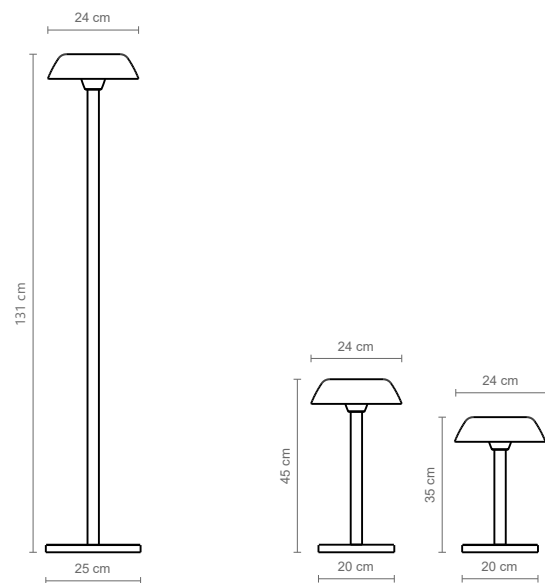

Sarria p

Sarria s L

Sarria s S

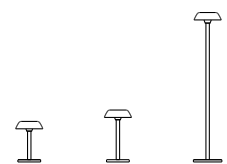

3266 3269 4270

ESTRUCTURA
STRUCTURE
STRUCTURE

● Blanco roto texturado RAL 9002
Textured off-white RAL 9002
Blanc cassé texturé mat RAL 9005

CABLE
CABLE
CÂBLE

PVC negro
Black PVC
PVC noir

3267 3270 4271

● Negro texturado RAL 9005
Textured black RAL 9005
Noir texturé RAL 9005

PVC negro
Black PVC
PVC noir

3268 3271 4272

● Terracotta RAL Design 050-040-50
Terracotta RAL Design 050-040-50
Terracotta RAL Design 050-040-50

PVC negro
Black PVC
PVC noir

Sarria c

Estructura en blanco, negro o terracota. Pantalla metálica con tulipa de cristal. Cable eléctrico de PVC negro.

Structure in white, black or terracotta. Metallic lampshade with glass disk. Black electrical PVC cable.

Structure en blanc, noir ou terracotta. Abat-jour métallique avec disque en cristal. Câble électrique PVC noir.



E-14 LED 12W



BIM/3D files: luxcambra.com/3D (3ds, dwg, 3dm, skp, rfa)

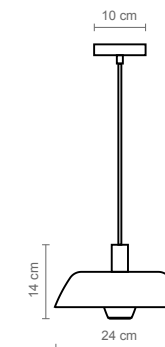

1657

ESTRUCTURA
STRUCTURE
STRUCTURE

● Blanco roto texturado RAL 9002
Textured off-white RAL 9002
Blanc cassé texturé mat RAL 9005

CABLE
CABLE
CÂBLE

PVC negro
Black PVC
PVC noir

1658

● Negro texturado RAL 9005
Textured black RAL 9005
Noir texturé RAL 9005

PVC negro
Black PVC
PVC noir

1659

● Terracotta RAL Design 050-040-50
Terracotta RAL Design 050-040-50
Terracotta RAL Design 050-040-50

PVC negro
Black PVC
PVC noir

Sirius

Bruno de Ávila

Una única estrella brilla en un cielo brumoso. Las estrellas se alinean creando formas y patrones que reconocemos como constelaciones. Sirius es una serie de lámparas modulares que pueden usarse individualmente para crear intimidad y misterio o combinarse, creando una constelación de varias formas y diferentes intensidades de luz, agregando personalidad a los espacios comerciales y residenciales. Es un sistema creativo que no termina en su fabricación y que permite cambios y adaptaciones. Los cables están cuidadosamente dirigidos por tubos curvos, lo que permite ajustes e inclinaciones.

A sole star shines in a misty sky. Stars align, creating shapes and patterns we recognize as constellations. Sirius is a series of modular lamps that can be used individually to create intimacy and mystery or combined, creating a constellation of various shapes and different light intensities, adding personality to commercial and residential spaces. It is a creative system that does not end in its manufacture. Instead, it allows changes and adaptations. The cables are neatly directed by curved tubes, allowing adjustments and tilts. Everytime you need to redecorate, you can also rotate its base.

Une seule étoile brille dans un ciel brumeux. Les étoiles s'alignent en créant des formes et des motifs que nous reconnaissons comme étant des constellations. Sirius est une série de lampes modulaires qui peuvent être utilisées individuellement pour créer une intimité et du mystère ou alors combinées en créant une constellation de formes variées et d'intensités lumineuses différentes, pour ajouter de la personnalité aux espaces commerciaux et résidentiels. C'est un système créatif qui va au delà de sa conception et qui permet des changements et des adaptations. Les câbles sont soigneusement acheminés à travers des tubes courbés, pour ajuster et incliner.

Familia / Family / Famille

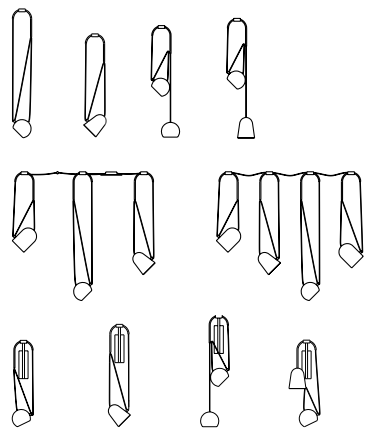



Elija el tipo de foco, la longitud del cable y el número de lámparas, según cada proyecto. Libertad sin caos.

Choose the type of spotlight, cable length and how many lamps, according to each project. Freedom without chaos.

Choisissez le type de spot, la longueur du câble et le nombre de lampes, en fonction de chaque projet. Une liberté sans chaos.





Sirius c

Estructura y pantalla en blanco, negro. Cable eléctrico de PVC negro.

Structure and lampshade in white or black. Black electrical PVC cable.

Structure et abat-jour en blanc ou noir. Câble électrique en PVC noir.



E-27 LED 12W
(Sirius c 1)



BIM/3D files: luxcambra.com/3D (3ds, dwg, 3dm, skp, rfa)

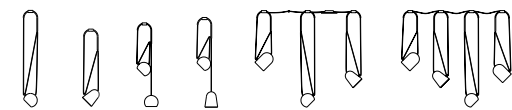
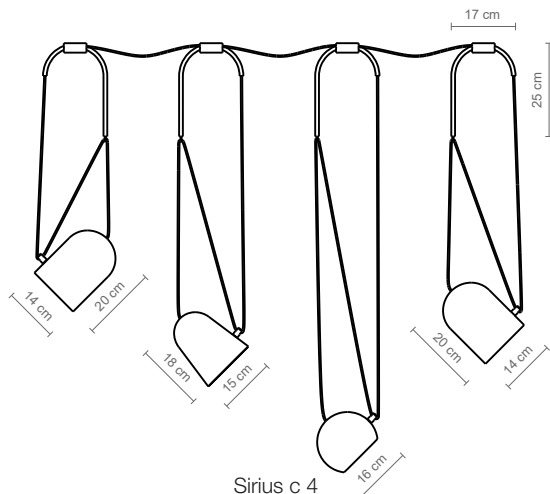
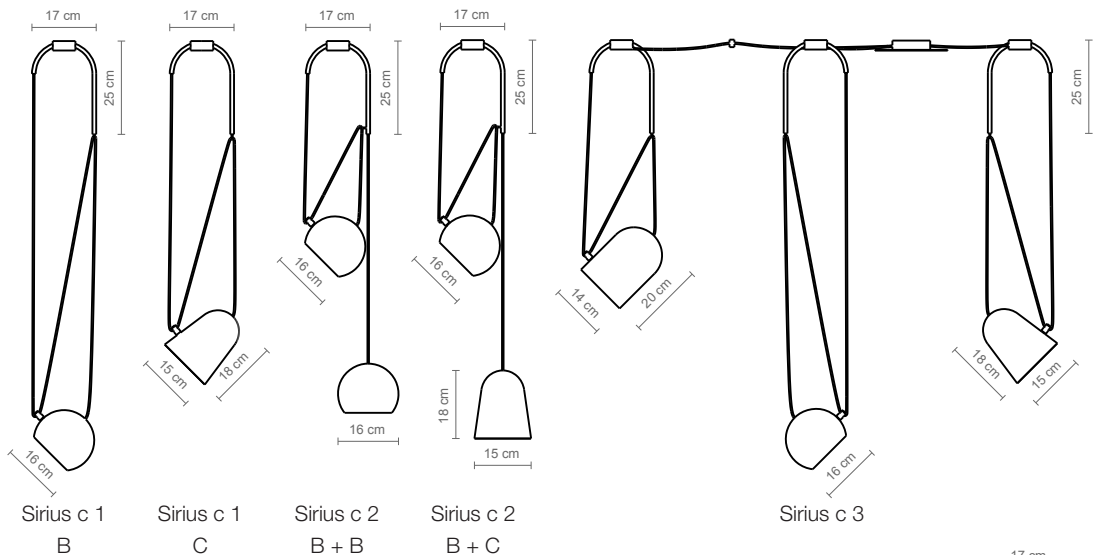

1553	1555	1557	1559	1563	1565
1554	1556	1558	1560	1564	1566

ESTRUCTURA Y PANTALLA STRUCTURE & SHADE STRUCT. ET ABAT-JOUR	CABLE CABLE CÂBLE
● Blanco mate Matt white Blanc mat	PVC negro Black PVC PVC noir
● Negro texturado Black textured Noir texturé	PVC negro Black PVC PVC noir

Sirius a

Estructura y pantalla en blanco, negro. Cable eléctrico de PVC negro.

Structure and lampshade in white or black. Black electrical PVC cable.

Structure et abat-jour en blanc ou noir. Câble électrique en PVC noir.



E-27 LED 12W



BIM/3D files: luxcambra.com/3D (3ds, dwg, 3dm, skp, rfa)

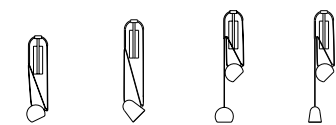
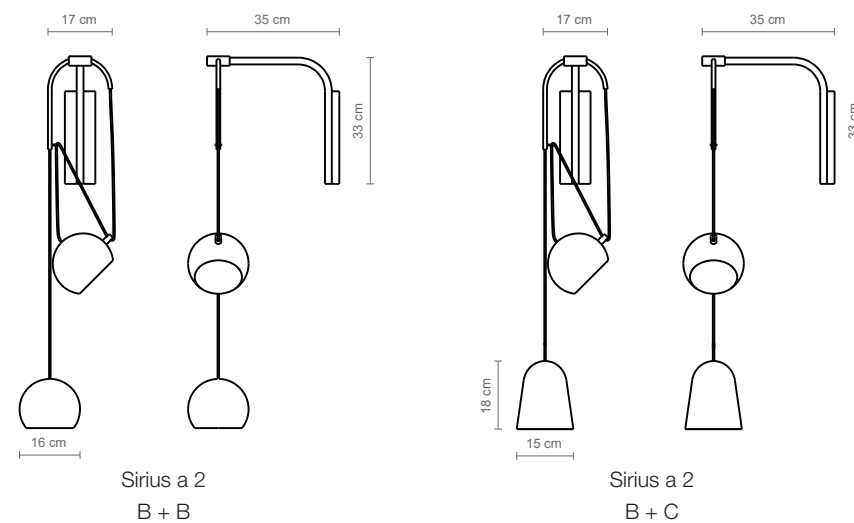
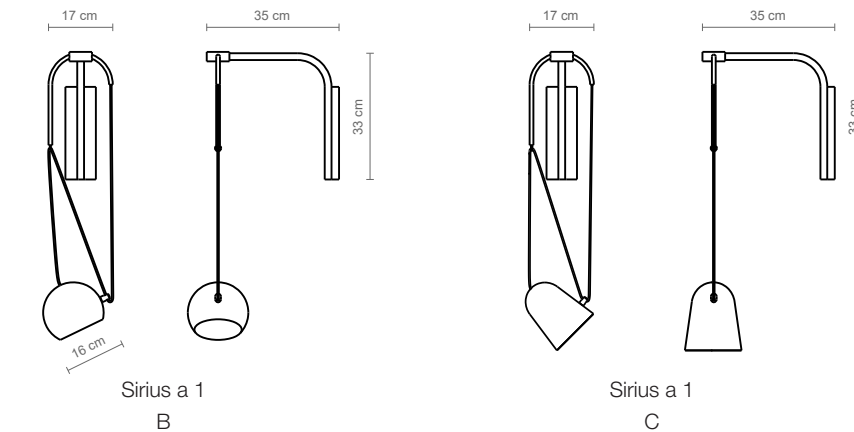

2616	2634	2636	2640
2617	2635	2637	2641

ESTRUCTURA Y PANTALLA STRUCTURE & METAL SHADE STRUCT. ET ABAT-JOUR	CABLE CABLE CÂBLE
● Blanco mate Matt white Blanc mat	PVC negro Black PVC PVC noir
● Negro texturado Black textured Noir texturé	PVC negro Black PVC PVC noir

Sutton

Xavier Solé

La pantalla de aluminio con un diseño básico en forma de cono es la protagonista de la colección Sutton. Con tres diámetros diferentes: 220, 350 y 500 mm, las tres pantallas comparten la misma tija superior, que estabiliza la lámpara en su horizontalidad. Toda la colección se fabrica en diferentes acabados lacados en epoxi y su fuente lumínica es una bombilla LED.

Su ligera pantalla metálica queda suspendida de forma elegante y aporta personalidad a cualquier ambiente.

The aluminum shade with a basic cone-shaped design is the main figure of the Sutton collection. With three different diameters: 220, 350 and 500 mm, the three shades have the same upper support which stabilizes the lamp horizontally. The entire collection is manufactured in different epoxy lacquered finishes and its light source is an LED bulb.

Its light metal shade is elegantly suspended to add personality to any type of environment.

L'abat-jour en aluminium avec son design simple en forme de cône est l'élément central de la collection Sutton. Avec trois diamètres différents: 220, 350 et 500 mm, les trois abat-jours ont la même barre supérieure, qui stabilise la lampe horizontalement. Toute la collection est fabriquée dans différentes finitions laquées époxy et sa source de lumière est une ampoule LED.

Son abat-jour en métal léger est élégamment suspendu, ce qui permet d'ajouter de la personnalité à n'importe quel type d'espace.

Familia / Family / Famille

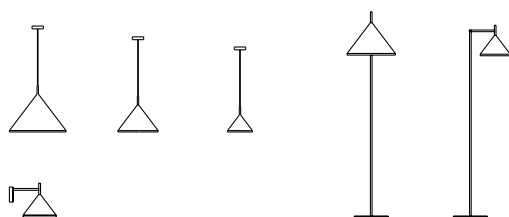





Sutton a / Sutton c

Estructura y pantalla en blanco o negro. Cable eléctrico de algodón negro.

Structure and lampshade in white or black. Black electrical cotton cable.

Structure et abat-jour en blanc ou noir. Câble électrique en coton noir.



E-14 LED 12W
(Sutton a / Sutton c 22)



E-27 LED 12W
(Sutton c 35)



BIM/3D files: luxcambra.com/3D (3ds, dwg, 3dm, skp, rfa)



2 x E-27 LED 12W
(Sutton c 50)

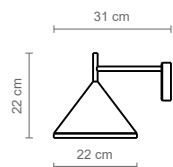

Sutton a

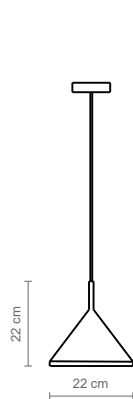

Sutton c S

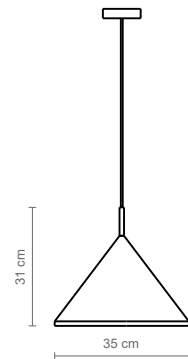

Sutton c M

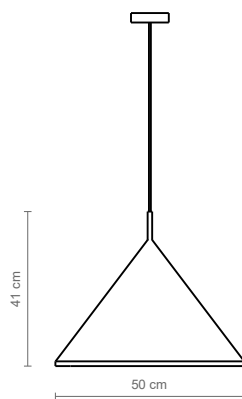

Sutton c L

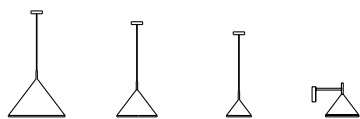

1360 1364 1368 2493

FLORÓN Y PANTALLA
CEILING ROSE & LAMP SHADE
PAVILLON ET ABAT-JOUR

● Negro texturado RAL 9005
Noir texturé RAL 9005
Textured black RAL 9005

CABLE
CABLE
CÂBLE

Algodón negro
Black cotton
Coton noir

1361 1365 1369 2494

● Blanco mate texturado RAL 9016
Textured matt white RAL 9016
Blanc texturé mat RAL 9016

Algodón negro
Black cotton
Coton noir

1362 1366 1370 2495

● Blanco roto texturado RAL 9002
Textured off-white RAL 9002
Blanc cassé texturé RAL 9002

Algodón negro
Black cotton
Coton noir

1363 1367 1371 2496

● Color RAL
RAL color
Couleur RAL

Algodón negro
Black cotton
Coton noir

Sutton p

Estructura y pantalla en blanco o negro. Cable eléctrico de PVC negro o transparente.

Structure and lampshade in white or black. Black or transparent electrical PVC cable.

Structure et abat-jour en blanc ou noir. Câble électrique en PVC noir ou transparent.



E-14 LED 12W
(Sutton p S)



2 x E-27 LED 12W
(Sutton p L)



BIM/3D files: luxcambra.com/3D (3ds, dwg, 3dm, skp, rfa)

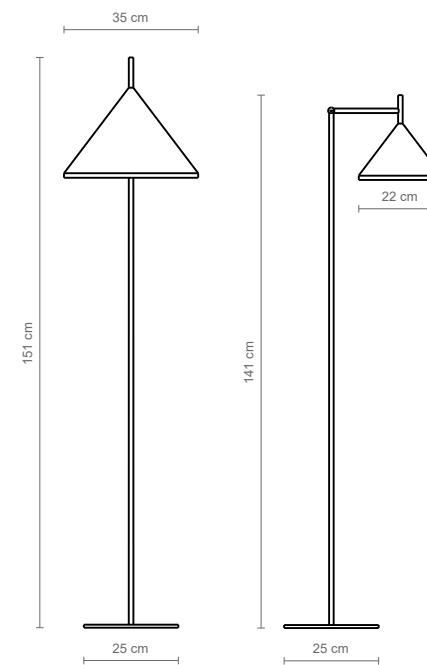

Sutton p L

Sutton p S

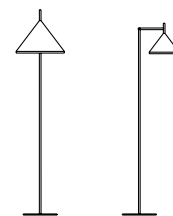

4185 4189

FLORÓN Y PANTALLA
CEILING ROSE & LAMP SHADE
PAVILLON ET ABAT-JOUR

● Negro texturado RAL 9005
Noir texturé RAL 9005
Textured black RAL 9005

CABLE
CABLE
CÂBLE

PVC negro
Black PVC
PVC noir

4186 4190

● Blanco mate texturado RAL 9016
Textured matt white RAL 9016
Blanc texturé mat RAL 9016

Transparente
Transparent
Transparent

4187 4191

● Blanco roto texturado RAL 9002
Textured off-white RAL 9002
Blanc cassé texturé RAL 9002

PVC negro
Black PVC
PVC noir

4188 4192

● Color RAL
RAL color
Couleur RAL

PVC negro
Black PVC
PVC noir

Teide

Luxcambra Team

El diseño de la lámpara Teide destaca por la variedad de materiales de sus pantallas. Cada uno de ellos aporta una personalidad y una luz diferente, cálida y rica en matices. Cada uno de los materiales humaniza y da carácter al espacio con su sola presencia. Se trata de una pieza muy versátil y decorativa y apropiada tanto para uso doméstico como para proyectos contract.

The design of the Teide lamp stands out for its large range of shade materials. Each shade creates a different atmosphere by diffusing a warm and nuanced source of light. Each material brings identity and character to the design of the environment. It is a versatile and decorative wall lamp, suitable for both domestic use and contract projects.

Le design de la lampe Teide se démarque par la variété de choix de matériaux des abat-jours. Chaque abat-jour apporte une personnalité et une source de lumière différente et riche en nuances. Chaque texture donne du caractère à l'espace environnant seulement par sa présence. Il s'agit d'un luminaire polyvalent et décoratif, qui s'adapte aussi bien pour un usage particulier que pour les projets contract.





Teide

Estructura en blanco, negro. Pantalla de loneta, lino, arpillera, osaka o cotonet. Cable de algodón negro.

Structure in white or black. Cotton, linen, sacking, osaka or cotonet lampshade. Black cotton cable.

Structure en blanc ou noir. Abat-jour en coton, lin, jute, osaka ou cotonet. Câble en coton noir.



E-27 LED 12W



BIM/3D files: luxcambra.com/3D (3ds, dwg, 3dm, skp, rfa)

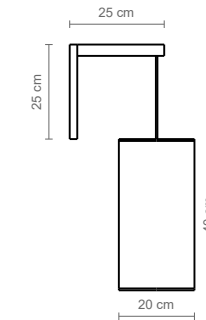

	ESTRUCTURA STRUCTURE STRUCTURE	PANTALLA LAMP SHADE ABAT-JOUR	CABLE CABLE CÂBLE
2497	● Blanco RAL 9002 White RAL 9002 Blanc RAL 9002	■ Lino blanco White linen Lin blanc	● Algodón negro Black cotton Coton noir
2498	● Blanco RAL 9002 White RAL 9002 Blanc RAL 9002	■ Osaka Osaka Osaka	● Algodón negro Black cotton Coton noir
2499	● Blanco RAL 9002 White RAL 9002 Blanc RAL 9002	■ Cotonet sand Sand cotonet Cotonet sand	● Algodón negro Black cotton Coton noir
2500	● Negro RAL 9005 Black RAL 9005 Noir RAL 9005	■ Lino blanco White linen Lin blanc	● Algodón negro Black cotton Coton noir
2234	● Negro RAL 9005 Black RAL 9005 Noir RAL 9005	■ Cotonet negro Black cotonet Cotonet noir	● Algodón negro Black cotton Coton noir
2235	● Negro RAL 9005 Black RAL 9005 Noir RAL 9005	■ Cotonet antracita Anthracite cotonet Cot. anthracite	● Algodón negro Black cotton Coton noir
2236	● Negro RAL 9005 Black RAL 9005 Noir RAL 9005	■ Loneta blanca White cotton Coton blanc	● Algodón negro Black cotton Coton noir
2237	● Negro RAL 9005 Black RAL 9005 Noir RAL 9005	■ Osaka Osaka Osaka	● Algodón negro Black cotton Coton noir
2501	● Negro RAL 9005 Black RAL 9005 Noir RAL 9005	■ Cotonet arena oscura Dark sand cotonet Cot. sable foncé	● Algodón negro Black cotton Coton noir

Terra

Bruno de Ávila

Una luz esférica parece emerger de un globo de corcho. Esto es Terra, según las teorías, la luna nació de nuestro planeta.

Su exterior está fabricado con materiales sostenibles que presentan una huella de carbono negativa para minimizar el impacto que generan los componentes eléctricos presentes en cualquier dispositivo de iluminación.

El equilibrio es en realidad el punto clave en su diseño. Por una simple interacción, es posible decidir el ángulo de luz o convertirlo en una lámpara decorativa flotante.

A spherical light seems to emerge from a cork globe. This is Terra, and according to theories, the moon was born from our planet.

Its exterior is made of sustainable materials of carbon negative footprint to minimize the impact generated by the electric components present in any lighting device.

Balance is actually a key point in its design. Through a simple interaction it's possible to decide the light angle or to shift it into a floating decorative lamp.

Une lumière sphérique semble émerger d'un globe en liège. C'est Terra, car selon les théories, la lune est née de notre planète.

Son extérieur est fait de matériaux durables avec une empreinte de carbone négative pour minimiser l'impact généré par les composants électriques présents dans n'importe quel appareil d'éclairage.

L'équilibre est en fait le point clé de sa conception. Grâce à une simple interaction, il est possible de décider de l'angle d'éclairage ou de la transformer en une lampe décorative flottante.

Familia / Family / Famille





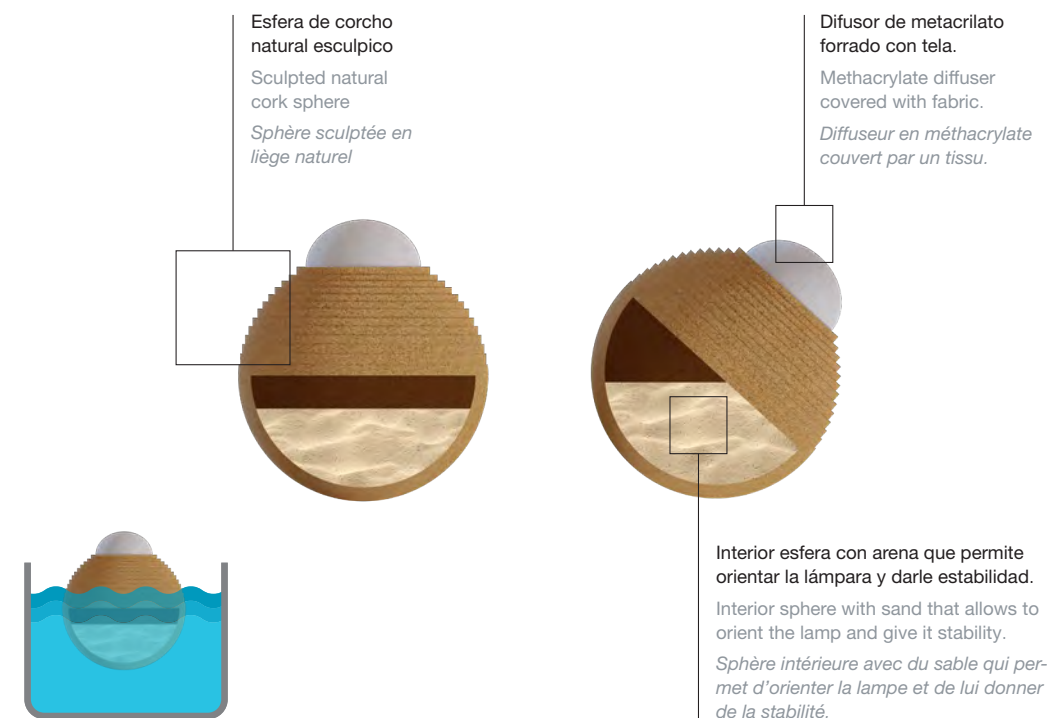

Lámpara IP 67 flotante. Tapa magnética y interior con espacio para guardar control remoto u otros objetos.
Clase III portátil con control a distancia, dimmer y timer.

Floating IP67 lamp. Magnetic cover and empty interior space to store remote control or other objects.
Class III portable with remote control, dimmer and timer.

*Lampe flottante IP67. Couvercle magnétique et espace vide intérieur pour ranger la télécommande ou d'autres objets.
Portable de classe III avec télécommande, variateur et minuteur.*

Terra es una pequeña escultura con luz donde todos los detalles están pensados para que se integre en la naturaleza. El material con el que está fabricada, el corcho, es un material 100% natural y biodegradable con unas características innatas únicas: es resistente y ligero, aislante térmico y acústico e impermeable a líquidos.

Terra is a small sculpture with light where all the details were designed to integrate it into nature. The material with which it is made, cork, is a 100% natural and biodegradable with unique innate characteristics: it is resistant and light, thermal and acoustic insulating but also impermeable to liquids.

Terra est une petite sculpture lumineuse où tous les détails sont pensés pour s'intégrer à la nature. Le matériau avec laquelle elle est fabriquée, le liège, est un matériau 100% naturel et biodégradable aux caractéristiques innées uniques : il est résistant et léger, isolant thermique et acoustique ainsi qu'imperméable aux liquides.



Las versiones de la colección Terra con conexión a red no son menos interesantes. Con dimensiones más reducidas por no contener arena en su interior, la esfera del aplique y del colgante permite jugar con la luz dirigiéndola a través de una ranura perfectamente trazada en el corcho.

The versions of the Terra collection with connection to network are also interesting. With smaller dimensions because it does not contain sand inside, the sphere for the wall and hanging lamps allows you to play with the light, directing it through a perfectly traced slot in the cork.

Les versions de la collection Terra avec connexion au réseau électrique sont aussi intéressantes. De plus petite dimension car elle ne contient pas de sable à l'intérieur, la sphère de l'applique et de la suspension permet de jouer avec la lumière en la dirigeant à travers une rainure parfaitement tracée dans le liège.

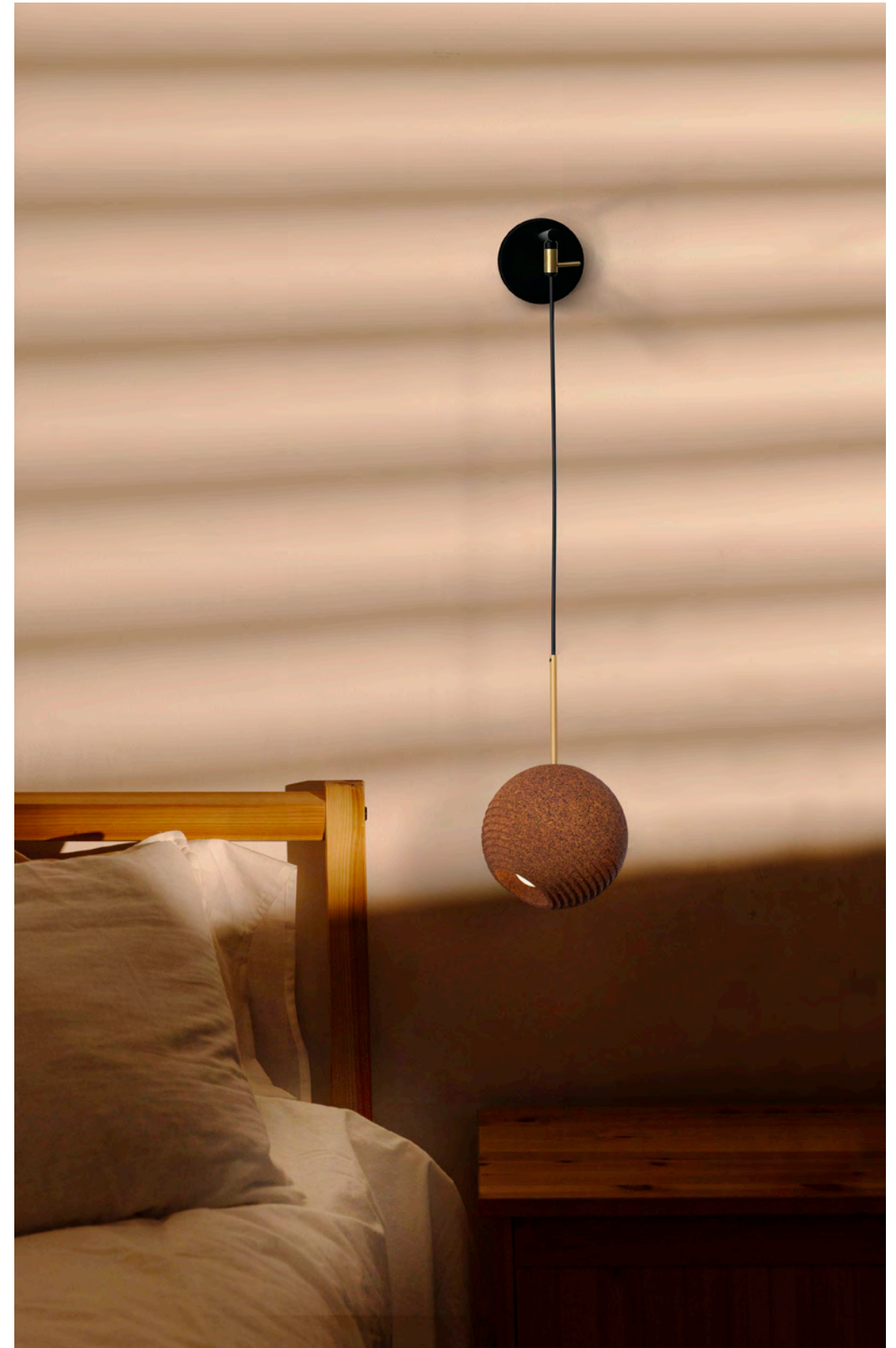

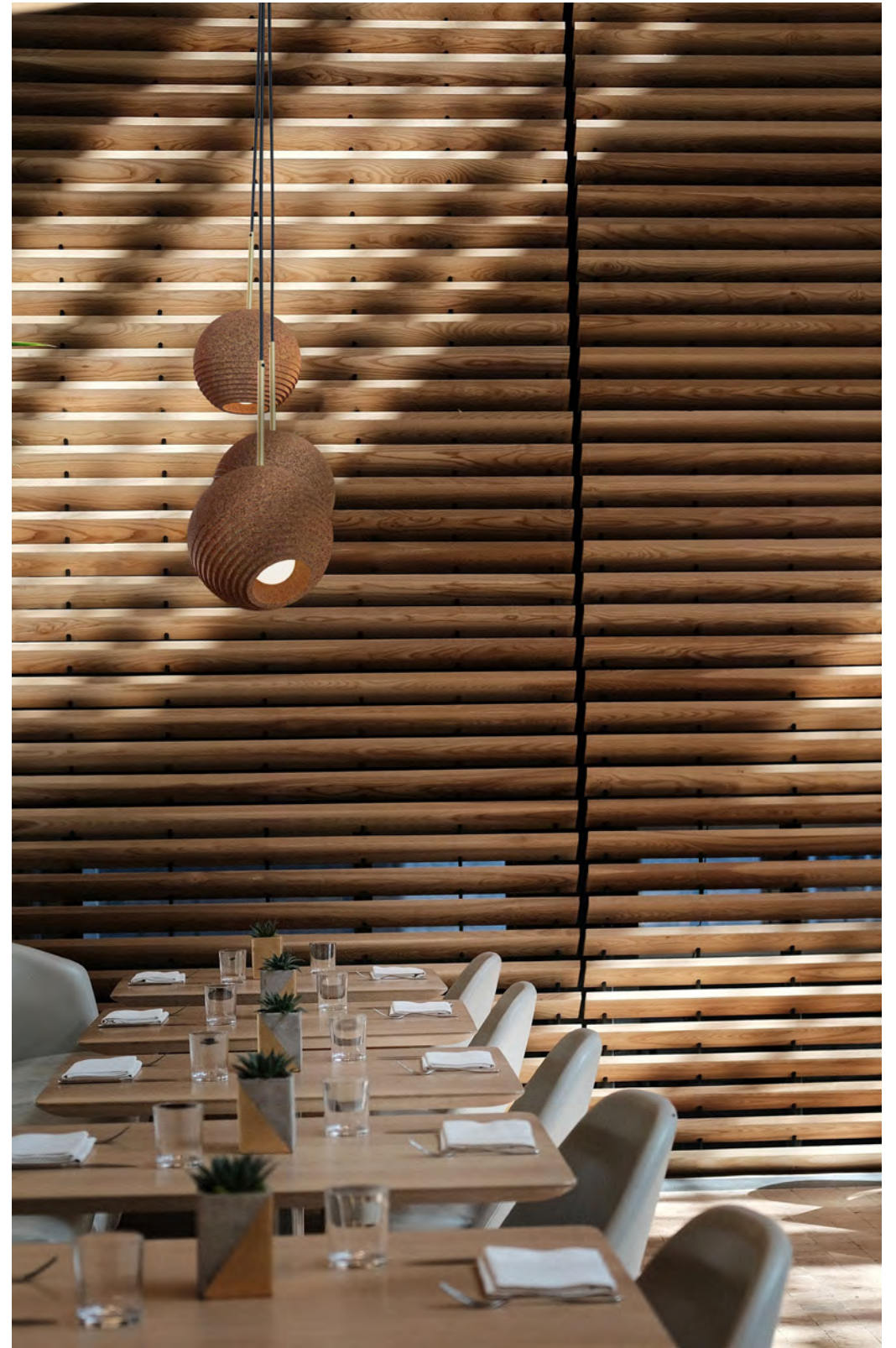



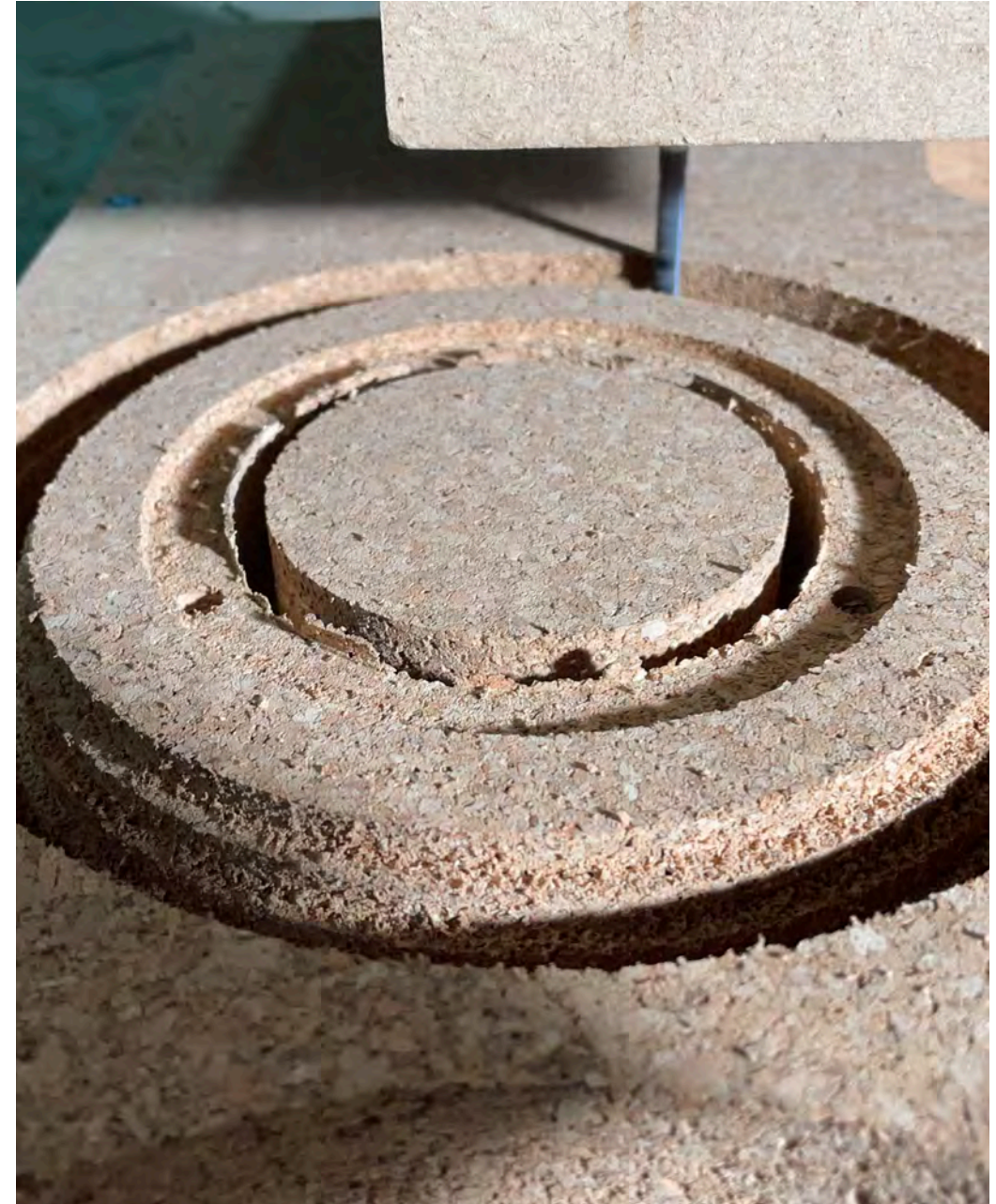

La esfera de corcho se fabrica y se mecaniza en Girona y proviene de alcornoques de la zona. Además, todos los residuos generados durante el proceso de producción se reutilizan.

The cork sphere is manufactured and mechanized in Girona and it comes from cork oaks in the region. In addition, all waste generated during the production process is reused.

La sphère en liège est fabriquée et mécanisée à Gérone et elle provient de chênes-lièges de la région. De plus, tous les déchets générés pendant le processus de production sont réutilisés.

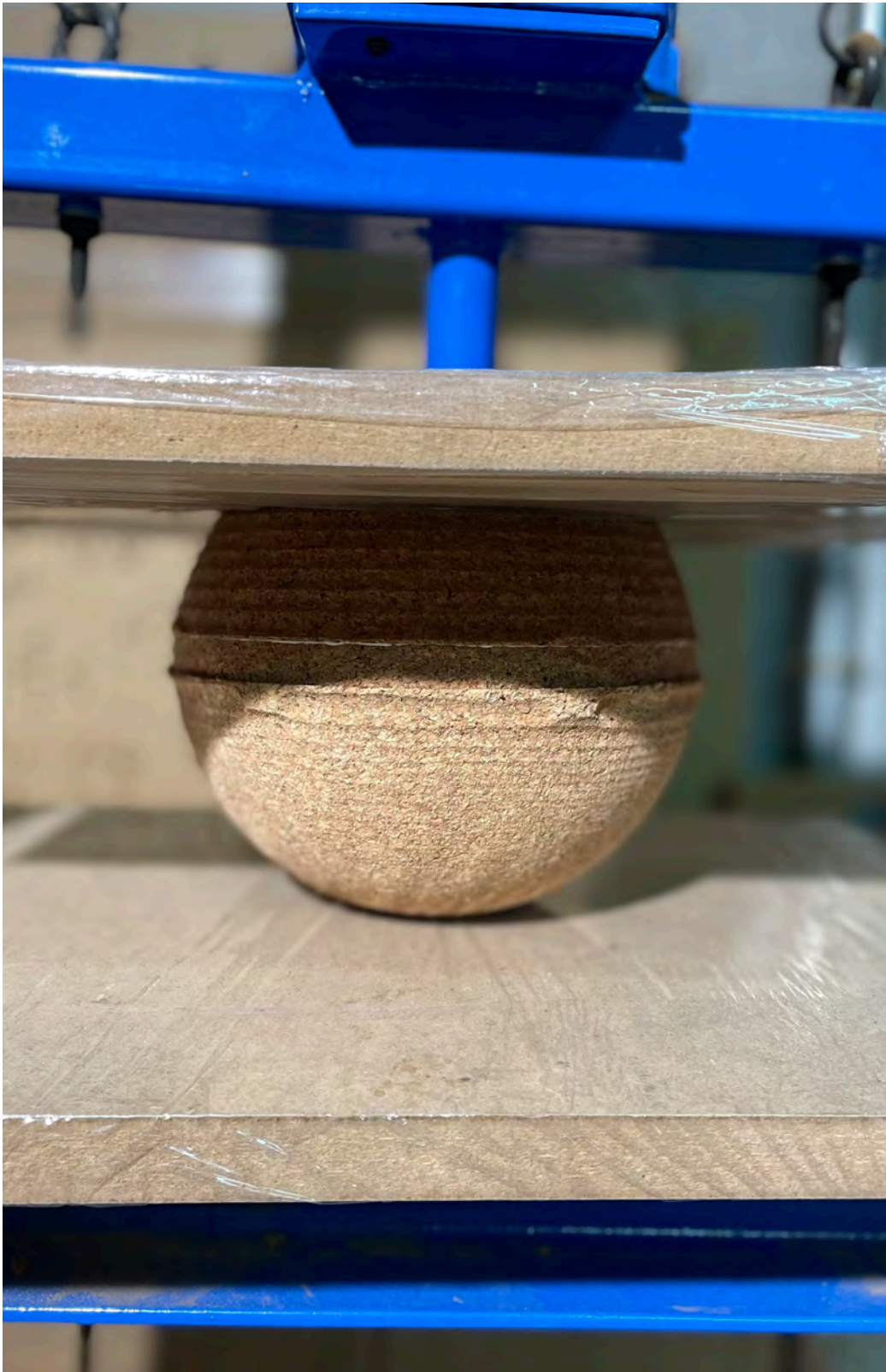

Terra a / Terra c

Estructura en blanco o negro y tija en latón satinado. Pantalla de corcho natural. Cable eléctrico de PVC negro.

Structure in white or black and satin brass tube. Natural cork lampshade. Black electrical PVC cable.

Structure en blanc ou noir et tige en laiton satiné. Abat-jour en liège naturel. Câble électrique en PVC noir.



E-14 LED 12W



BIM/3D files: luxcambra.com/3D (3ds, dwg, 3dm, skp, rfa)

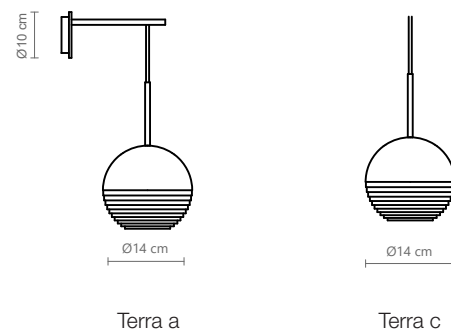

Terra a

Terra c



		ESTRUCTURA STRUCTURE STRUCTURE	PANTALLA LAMP SHADE ABAT-JOUR	CABLE CABLE CÂBLE
2900	1720	Latón satinado y negro Satin brass and black <i>Laiton satiné et noir</i>	Corcho acústico claro Light acoustic cork <i>Liège acoustique clair</i>	PVC negro <i>Black PVC</i> <i>PVC noir</i>
2901	1721	Latón satinado y blanco roto Satin brass and off-white <i>Laiton satiné et blanc cassé</i>	Corcho acústico claro Light acoustic cork <i>Liège acoustique clair</i>	PVC negro <i>Black PVC</i> <i>PVC noir</i>

Terra s portátil

Pantalla de corcho natural. Módulo led sin conexión a red. Alimentación con fuente de luz led con batería recargable. 6h duración máxima potencia.

Natural cork lampshade. Led module without connection cable. Power source supply with rechargeable battery. 6h of battery life.

Abat-jour en liège naturel. Module led sans connexion de câble. Source d'alimentation LED avec batterie rechargeable. 6h d'autonomie de batterie.



290 lm / 3.000K



BIM/3D files: luxcambra.com/3D (3ds, dwg, 3dm, skp, rfa)

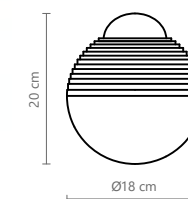

	ESTRUCTURA Y PANTALLA STRUCTURE Y LAMP SHADE STRUCTURE ET ABAT-JOUR	CARACTERÍSTICAS ELÉCTRICAS ELECTRICAL CHARACTERISTICS CARACTÉRISTIQUES ÉLECTRIQUES
3309	Corcho claro Light cork <i>Liège clair</i>	Batería recargable IP67 Rechargeable battery IP67 <i>Batterie rechargeable IP67</i>

Thea

Xavier de Santos

Thea es una lámpara de pie giratoria con brazo oscilante que puede regular su altura de manera eficiente gracias al contrapeso asistido por un mecanismo de fricción. Se trata de una lámpara de gran equilibrio estético entre sus materiales sostenibles y muy dinámica gracias a su geometría.

La estructura y la base son de madera, cemento y hierro. La madera en el cuerpo aporta calidez y el panot “flor de Barcelona”, identitario de la ciudad donde se ha diseñado y fabrica esta lámpara, da peso y estabilidad a la base.

The Thea lamp is a swing arm floor lamp with adjustable height thanks to its counterweight system by friction mechanism. It is a lamp with a great aesthetic balance between its sustainable materials and its dynamic geometry.

The structure and the base are made of wood, cement and iron. The wood in the structure provides warmth and the floor support is the “Barcelona flower panot” which is a symbol of identity of Barcelona city where this lamp was designed and manufactured. The base gives both weight and stability to the lamp.

Thea est une lampe de pied pivotante avec un bras articulé qui permet d'ajuster efficacement sa hauteur grâce à son système de contrepoids par un mécanisme de friction. C'est une lampe avec un grand équilibre esthétique entre ses matériaux durables, mais aussi très dynamique grâce à sa géométrie.

La structure et la base sont en bois, ciment et fer. Le bois de la structure apporte de la chaleur et le support de pied appelé « panot fleur de Barcelone », représente l'identité de la ville où cette lampe a été conçue et fabriquée, tout en donnant du poids et de la stabilité à la base.

Familia / Family / Famille

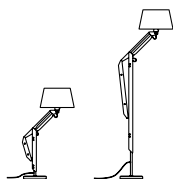





Thea s / Thea p

Estructura en hierro y madera de haya. Base en hierro. Pantalla de cotonet. Cable eléctrico de PVC negro.

Structure in iron and natural beech wood. Base in iron finish. Cotonet lampshade. Black electrical PVC cable.

Structure en fer et bois de hêtre naturel. Base en fer. Abat-jour en cotonet. Câble électrique en PVC noir.



E-27 LED 12W



BIM/3D files: luxcambra.com/3D (3ds, dwg, 3dm, skp, rfa)

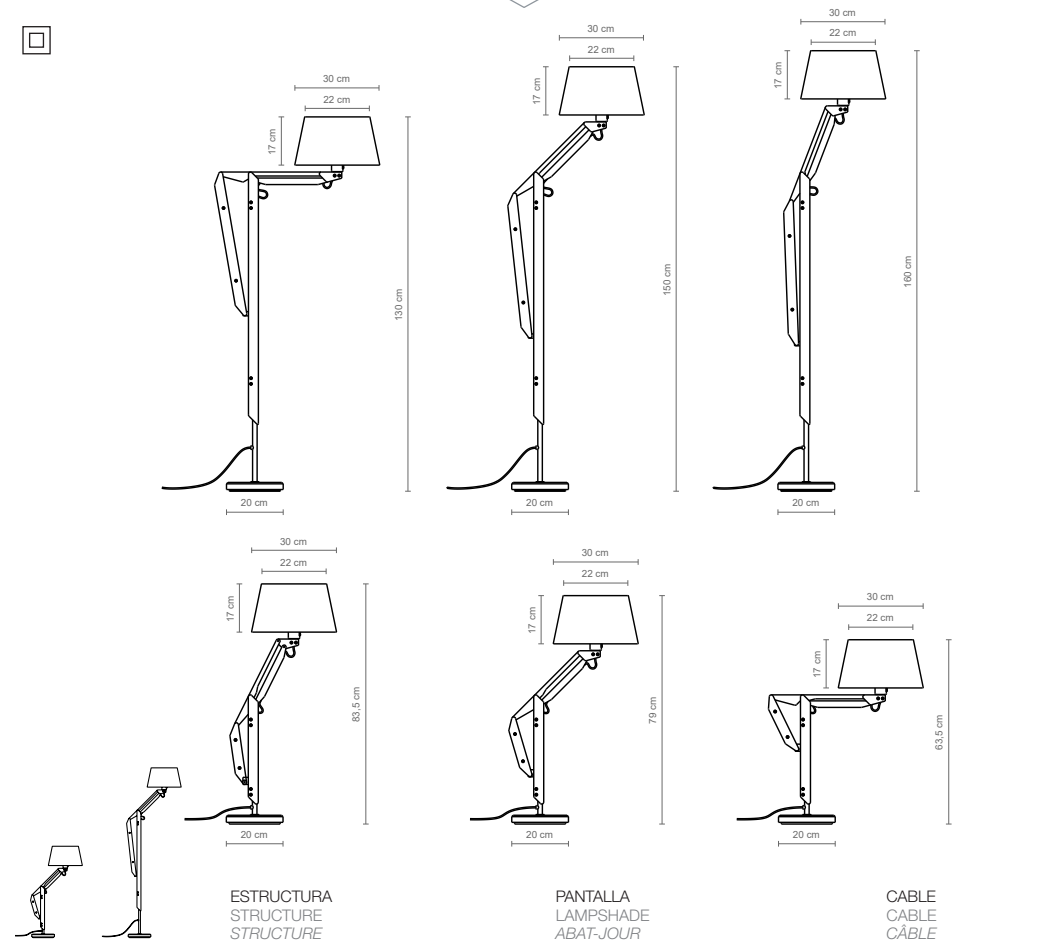

		ESTRUCTURA STRUCTURE STRUCTURE	PANTALLA LAMP SHADE ABAT-JOUR	CABLE CABLE CÂBLE
3210	4240	● Hierro y madera de haya Iron and beech wood <i>Fer et bois de hêtre</i>	■ Cotonet gris frío Cold grey cotonet <i>Cotonet gris froid</i>	PVC negro Black PVC <i>PVC noir</i>
3211	4241	● Hierro y madera de haya Iron and beech wood <i>Fer et bois de hêtre</i>	■ Cotonet arena oscura Dark sand cotonet <i>Cotonet sable sombre</i>	PVC negro Black PVC <i>PVC noir</i>
3212	4242	● Hierro y madera de haya Iron and beech wood <i>Fer et bois de hêtre</i>	■ Cotonet blanco White cotonet <i>Cotonet blanc</i>	PVC negro Black PVC <i>PVC noir</i>
3213	4243	● Hierro y madera de haya Iron and beech wood <i>Fer et bois de hêtre</i>	■ Cotonet sand Sand cotonet <i>Cotonet sand</i>	PVC negro Black PVC <i>PVC noir</i>

Thira

Luxcambra Team

La lámpara de suspensión Thira está pensada para ofrecer una luz cálida en ambientes de trabajo, cocinas tipo office y decoraciones minimalistas. Se trata de una lámpara con un diseño muy versátil y que se ofrece en múltiples medidas.

The Thira hanging lamp was designed to offer a warm light in work environments, office kitchens and minimalist decorations. It is a lamp with a very versatile design, available in multiple sizes.

La suspension Thira est conçue pour offrir une lumière chaleureuse dans les environnements de travail, les cuisines-office équipées et les décorations minimalistes. C'est une lampe au design très polyvalent qui est proposée en plusieurs tailles.





Thira

Estructura y florón en blanco o negro. Cable PVC negro.

White or black structure and ceiling support. Black PVC cable.



Tira LED 23W (Thira 88 cm) 4.600 Lumens 3.000 K	Tira LED 32W (Thira 115 cm) 5.400 Lumens 3.000 K	Tira LED 48W (Thira 175 cm) 6.700 Lumens 3.000 K
--	---	---

Structure et support plafond en blanc ou noir. Câble PVC noir.



BIM/3D files: luxcambra.com/3D (3ds, dwg, 3dm, skp, rfa)

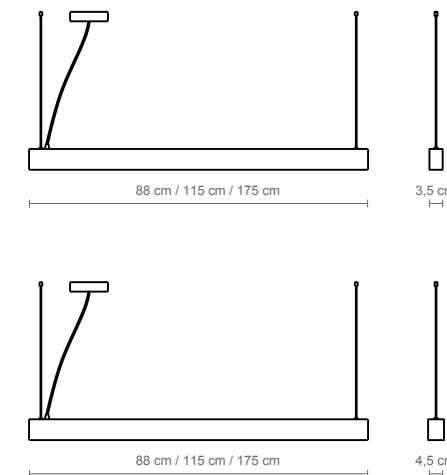

THIRA 35 mm

1372	1375	1378
------	------	------

ESTRUCTURA STRUCTURE

● Negro texturado RAL 9005
Textured black RAL 9005
Noir texturé RAL 9005

CABLE CÂBLE

PVC negro
Black PVC
PVC noir

1373	1376	1379
------	------	------

● Blanco mate texturado RAL 9016
Textured matt white RAL 9016

PVC negro
Black PVC
Blanc texturé mat RAL

9016 PVC noir

THIRA 45 mm

1381	1384	1387
------	------	------

ESTRUCTURA STRUCTURE

● Negro texturado RAL 9005
Textured black RAL 9005
Noir texturé RAL 9005

CABLE CÂBLE

PVC negro
Black PVC
PVC noir

1382	1385	1388
------	------	------

● Blanco mate texturado RAL 9016
Textured matt white RAL 9016
Blanc texturé mat RAL 9016

PVC negro
Black PVC
PVC noir

Torso

Jordi Llopis

Los apliques Torso se inspiran en el cuerpo humano ya que puede ser vestido con cualquier tipo de tejido o material y permite crear distintos ambientes, con luz más general o más tamizada según la elección del mismo.

The Torso wall lamps are inspired by the concept of a human body which can be dressed in any type of fabrics. This diversity is reflected here by the distinct options of the lamp allowing different environments to be created, with more or less dimmed light depending on the choice made.



Les appliques murales Torso s'inspirent du corps humain car elles peuvent être habillées de tout type de tissu ou de matériau et permettent de créer différents environnements, avec une lumière plus générale ou plus tamisée selon le choix de celui-ci.





Torso

Estructura en blanco, negro o terracota. Pantalla de cotonet o rafia.

White, black or terracotta structure. Cotonet or raffia lampshade.

Structure en blanc, noir ou terracotta. Abat-jour en cotonet ou raphia.



E-27 LED 12W



LED 3W

150 lm / 2.700K



BIM/3D files: luxcambra.com/3D (3ds, dwg, 3dm, skp, rfa)

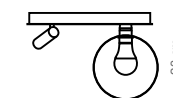
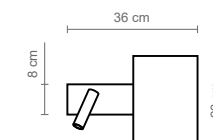

	ESTRUCTURA STRUCTURE STRUCTURE	PANTALLA LAMP SHADE ABAT-JOUR
2709	● Blanco roto texturado RAL 9002 Off-white textured RAL 9002 Blanc cassé texturé RAL 9002	■ Cotonet blanco White cotonet Cotonet blanco
2710	● Blanco roto texturado RAL 9002 Off-white textured RAL 9002 Blanc cassé texturé RAL 9002	■ Cotonet sand Cotonet Sand Cotonet sable
2711	● Blanco roto texturado RAL 9002 Off-white textured RAL 9002 Blanc cassé texturé RAL 9002	■ Cotonet gris frío Cold grey cotonet Cotonet gris froid
2712	● Blanco roto texturado RAL 9002 Textured off-white RAL 9002 Blanc cassé texturé RAL 9002	■ Raffia Raffia Raphia
2713	● Negro texturado RAL 9005 Textured black RAL 9005 Noir texturé RAL 9005	■ Cotonet blanco White cotonet Cotonet blanco
2714	● Negro texturado RAL 9005 Textured black RAL 9005 Noir texturé RAL 9005	■ Cotonet sand Sand cotonet Cotonet sable
2715	● Negro texturado RAL 9005 Textured black RAL 9005 Noir texturé RAL 9005	■ Cotonet gris frío Cold grey cotonet Cotonet gris froid
2716	● Negro texturado RAL 9005 Textured black RAL 9005 Noir texturé RAL 9005	■ Raffia Raffia Raphia
2717	● Terracota RAL design 050-40-50 Terracotta RAL design 050-40-50	■ Cotonet blanco White cotonet Cotonet blanc
2718	● Terracota RAL design 050-40-50 Terracotta RAL design 050-40-50	■ Cotonet sand Sand cotonet Cotonet sable

Toscana

Luxcambra Team

La colección Toscana es elegante y austera gracias a sus proporciones y su sencillez formal. Sus pantallas encintadas en algodón proporcionan una luz cálida y agradable. Su silueta clásica y la simplicidad de sus formas hace que encaje en cualquier ambiente.

The Toscana collection is elegant thanks to its proportions and formal simplicity. Its ribboned lampshades provide a warm and pleasant light. Its classic and sober design makes it fit into any kind of environment.

La collection Toscana est élégante avec ses proportions et sa simplicité formelle. Ses abat-jours enrubannés apportent une lumière chaude et agréable. Sa silhouette classique et sa sobriété lui permettent de s'intégrer dans n'importe quel environnement.

Familia / Family / Famille

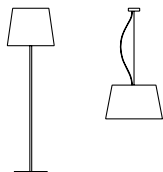





Toscana c

Estructura en blanco o negro. Pantalla encintada en blanco, negro, beige o rojo, de lino o cotonet. Cable algodón negro.

White or black structure. Linen, cotonet or ribboned in white, black, beige or red shade. Black cotton cable.

Structure en blanc ou noir. Abat-jour enrubanné en blanc, noir, beige ou rouge, en lin ou cotonet. Câble en coton noir.



2 x E-27 LED 12W



BIM/3D files: luxcambra.com/3D (3ds, dwg, 3dm, skp, rfa)

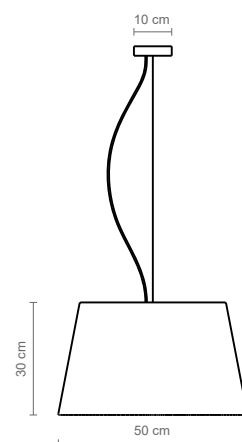

	FLORÓN CEILING ROSE PAVILLON	PANTALLA LAMP SHADE ABAT-JOUR	CABLE CABLE CÂBLE
1044	● Blanco mate Matt white <i>Blanc mat</i>	■ Encintada blanca White ribboned <i>Ruban blanc</i>	● Algodón negro Black cotton <i>Coton noir</i>
1045	● Negro Black <i>Noir</i>	■ Encintada roja Red ribboned <i>Ruban rouge</i>	● Algodón negro Black cotton <i>Coton noir</i>
1046	● Negro Black <i>Noir</i>	■ Encintada beige Beige ribboned <i>Ruban beige</i>	● Algodón negro Black cotton <i>Coton noir</i>
1047	● Negro Black <i>Noir</i>	■ Encintada negra Black ribboned <i>Ruban noir</i>	● Algodón negro Black cotton <i>Coton noir</i>
1399	● Negro Black <i>Noir</i>	■ Lino blanco White linen <i>Lin blanc</i>	● Algodón negro Black cotton <i>Coton noir</i>
1400	● Negro Black	■ Cotonet (consultar colores) Cotonet (check colors) <i>Cotonet (vérifier les couleurs)</i>	● Algodón negro Black cotton <i>Coton noir</i>

Toscana p

Estructura en blanco o negro. Pantalla encintada en blanco, negro, beige o rojo, de lino o cotonet. Cable eléctrico de PVC negro.

White or black structure. Linen, cotonet or ribboned in white, black, beige or red shade. Black electrical PVC cable.

Structure en blanc ou noir. Abat-jour enrubanné en blanc, noir, beige ou rouge, en lin ou cotonet. Câble électrique en PVC noir.



E-27 LED 12W



BIM/3D files: luxcambra.com/3D (3ds, dwg, 3dm, skp, rfa)

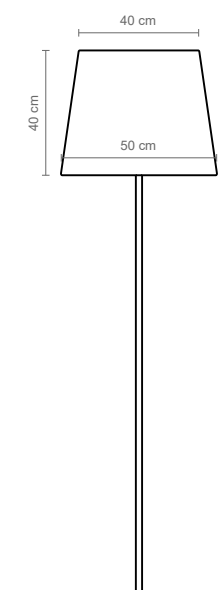

	ESTRUCTURA STRUCTURE STRUCTURE	PANTALLA LAMP SHADE ABAT-JOUR	CABLE CABLE CÂBLE
4152	● Negro Black <i>Noir</i>	■ Encintada blanca White ribboned <i>Ruban blanc</i>	● PVC negro Black PVC <i>PVC noir</i>
4153	● Negro Black <i>Noir</i>	■ Encintada roja Red ribboned <i>Ruban rouge</i>	● PVC negro Black PVC <i>PVC noir</i>
4154	● Negro Black <i>Noir</i>	■ Encintada beige Beige ribboned <i>Ruban beige</i>	● PVC negro Black PVC <i>PVC noir</i>
4155	● Negro Black <i>Noir</i>	■ Encintada negra Black ribboned <i>Ruban noir</i>	● PVC negro Black PVC <i>PVC noir</i>
4193	● Negro Black <i>Noir</i>	■ Lino blanco White linen <i>Lin blanc</i>	● PVC negro Black PVC <i>PVC noir</i>
4194	● Negro Black <i>Noir</i>	■ Cotonet (consultar colores) Cotonet (check colors) <i>Cotonet (vérifier les couleurs)</i>	● PVC negro Black PVC <i>PVC noir</i>

Uec

Luxcambra Team

La colección Uec se fabrica en dos acabados: blanco y dorado o negro y dorado. Con su doble pantalla metálica que proyecta su foco de luz hacia arriba y hacia abajo se trata de una pieza muy decorativa y apropiada tanto para uso doméstico como para proyectos contract.

The Uec collection is available in two finishes: white and gold or black and gold. Its double metal shades projecting the light upwards and downwards makes it a very decorative lamp suitable for both domestic use and for contract projects.

La collection Uec est disponible en deux finitions : blanc et or ou noir et or. Ses deux abat-jours métalliques projetant de la lumière vers le haut et vers le bas en fait une lampe très décorative qui convient aussi bien à un usage domestique qu'à des projets contract.





Uec

Estructura en negro y dorado o blanco y dorado.

Black and gold or white and gold structure.

Structure en noir et doré ou blanc et doré.



2 x G9 LED 6W



BIM/3D files: luxcambra.com/3D (3ds, dwg, 3dm, skp, rfa)

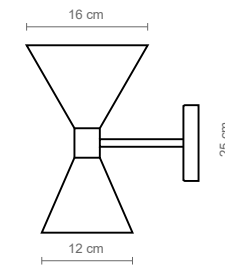

ESTRUCTURA
STRUCTURE
STRUCTURE

2179

 Blanco y dorado
White & gold | *Blanc et doré*

2180

 Negro y dorado
Black & gold | *Noir et doré*

Ufo

Luxcambra team

El diseño de la lámpara Ufo destaca por la variedad de materiales de sus pantallas. Cada uno de ellos aporta una personalidad y una luz diferente, cálida y rica en matices. Cada uno de los materiales humaniza y da carácter al espacio con su sola presencia.

Pensando en su uso para lugares públicos, ofrecemos la posibilidad de fabricarla en grandes formatos con diámetros hasta 150 cm.

The design of this lamp stands out for the variety of materials available for its lampshades. Each of them brings a different personality and warm nuances. This spectrum of materials allows you to give more character to any space.

As it was thought to be used in public places, we offer the possibility of manufacturing this lamp in large formats with diameters up to 150 cm.

Le design de la lampe Ufo se distingue par la variété de matériaux disponibles pour ses abat-jours. Chacun d'entre eux apporte une personnalité et une lumière différente, à la fois chaude et riche en nuances. Chacun des matériaux donne du caractère à l'espace par sa seule présence.

Ayant pensé à son utilisation pour les lieux publics, nous offrons la possibilité de la fabriquer en grands formats avec des diamètres allant jusqu'à 150 cm.





Ufo

Florón en blanco o negro. Pantalla de loneta, arpillera, cotonet, osaka, screen o lino. Medidas especiales (hasta 150 cm). Cable eléctrico de algodón negro. Difusor de pergamino de policarbonato.

White or black structure. Cotton, sacking, cotonet, osaka, screen or linen lampshade. Special sizes (up to 150 cm). Black electrical cotton cable. Polycarbonate parchment diffuser.

Structure en blanc ou noir. Abat-jour en coton, jute, cotonet, osaka, screen ou lin. Mesures spéciales (jusqu'à 150 cm). Câble électrique en coton noir. Diffuseur en parchemin de polycarbonate.



3 x E-27 LED 12W



BIM/3D files: luxcambra.com/3D (3ds, dwg, 3dm, skp, rfa)

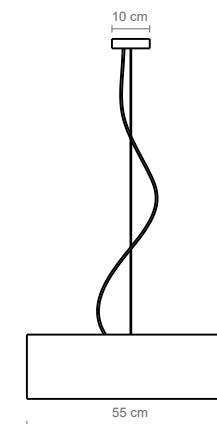

	FLORÓN CEILING ROSE PAVILLON	PANTALLA LAMP SHADE ABAT-JOUR	CABLE CABLE CÂBLE
1407	● Negro Black Noir	■ Lino blanco White linen Lin blanc	● Algodón negro Black cotton Coton noir
1408	● Negro Black Noir	■ Loneta natural Natural cotton Coton naturel	● Algodón negro Black cotton Coton noir
1409	● Blanco White Blanc	■ Screen blanco White screen Screen blanc	● Algodón negro Black cotton Coton noir
1410	● Negro Black Noir	■ Screen beige Beige screen Screen beige	● Algodón negro Black cotton Coton noir
1411	● Negro Black Noir	■ Osaka Osaka Osaka	● Algodón negro Black cotton Coton noir
1412	● Negro Black Noir	■ Saco Sack Jute	● Algodón negro Black cotton Coton noir
1413	● Negro Black Noir	■ Arpillera beige Beige sacking Toile beige	● Algodón negro Black cotton Coton noir
1416	● Blanco White Blanc	■ Cotonet blanco White cotonet Cotonet blanc	● Algodón negro Black cotton Coton noir
1417	● Negro Black Noir	■ Cotonet gris frío Cold gray cot. Cot. gris froid	● Algodón negro Black cotton Coton noir
1172	● Negro Black Noir	■ Cotonet negro Black cotonet Cotonet noir	● Algodón negro Black cotton Coton noir
1173	● Negro Black Noir	■ Cotonet antracita Anthracite cot. Cot. anthracite	● Algodón negro Black cotton Coton noir



JOAN CAMBRA

Joan Cambra, fundador de la empresa de iluminación Lux en los años 60 y diseñador autodidacta, consiguió con su carácter carismático e inquieto crear un estilo propio en el mundo de la iluminación decorativa. En el año 1988, entrevistado en la revista Hogares dijo: “Para mi la satisfacción recae en el trabajo bien hecho, no en la forma. No me importa que se conozca mi nombre, sino que mis lámparas gusten y perduren en el tiempo”.

Joan Cambra, founder of the Lux lighting company in the 1960s and a self-taught designer, managed to create his own style in the world of decorative lighting with his charismatic and restless character. In 1988, interviewed in “Hogares” magazine, he said: “For me, satisfaction relies on a job well done, not in its form. I don’t care if my name is well-known or not, as long as my lamps are appreciated and last over time.”

Joan Cambra, fondateur de la société d'éclairage Lux dans les années 1960 et designer autodidacte, a réussi avec son caractère charismatique et curieux à créer son propre style dans le monde de l'éclairage décoratif. En 1988, interviewé dans le magazine Hogares, il déclare : « Pour moi, la satisfaction réside dans le travail bien fait, pas dans sa forme. Peu m'importe que mon nom soit connu, mais plutôt que mes lampes plaisent et durent dans le temps ».

XAVIER SOLÉ

Lleida, 1959. Diseñador industrial por Escola Elisava de Barcelona y por IED de Milán. Empezó su carrera en el estudio AGENZIA DESIGN, en Milán. En 1992 dirige el Dep. de I+D de la empresa AMAT-3 y en 2006 asume la Dirección Técnica de la Empresa TRAMO, hasta 2012, cuando vuelve a abrir su propio estudio de diseño en Barcelona hasta la actualidad.

Lleida, 1959. Industrial designer from Escola Elisava in Barcelona and IED in Milan. He started his career at the AGENZIA DESIGN studio in Milan. In 1992, he directed the R&D Department of the AMAT-3 company and in 2006 he assumed the Technical Management of the TRAMO Company, until 2012, when he reopened his own design studio in Barcelona where he still works today.

Lleida, 1959. Designer industriel de l'Escola Elisava à Barcelone et IED à Milan. Il a débuté sa carrière au studio AGENZIA DESIGN à Milan. En 1992, il a dirigé le département R&D de la société AMAT-3 et en 2006, il a pris la direction technique de la société TRAMO, jusqu'en 2012, date à laquelle il a rouvert son propre studio de design à Barcelone, où il continue de travailler aujourd'hui.



JORDI LLOPIS

Funda el estudio Jordi Llopis Design y la editora Brots. Colabora con distintas empresas en el ámbito de la iluminación, mobiliario y objeto. Llopis es MA Diseño para Royal College of Art en Londres y BA Industrial Design para Elisava. Docente en ESDI, ESDesign y colabora con Elisava Alumni. A partir de 2021 colabora muy estrechamente con la empresa Luxcambra, dedicándose al desarrollo de nuevos productos y la dirección de producto de la empresa.

Founds the Jordi Llopis Design studio and the Brots publishing house. He collaborates with different companies in the field of lighting, furniture and objects. Jordi Llopis obtains a master's degree in Design from the Royal College of Art in London, and a BA Industrial Design from Elisava. He is also a teacher at ESDI, ESDesign and collaborates with Elisava Alumni. From 2021, he collaborates very closely with the company Luxcambra, dedicating himself to the development of new products and the company's product management.

Il fonde le studio Jordi Llopis Design et l'editorial Brots. Il collabore avec différentes entreprises dans le domaine de l'éclairage, du mobilier et des objets. Jordi Llopis est titulaire d'une maîtrise en design du Royal College of Art de Londres et d'un BA en design industriel de l'Elisava. Il est aussi enseignant à l'ESDI, ESDesign et collabore avec Elisava Alumni. À partir de 2021, il collabore très étroitement avec l'entreprise Luxcambra, en se consacrant au développement des nouveaux produits et à la gestion des produits de l'entreprise.

BRUNO DE ÁVILA

Diseñador gráfico y de producto brasileño, actualmente desarrolla lámparas y mobiliario para empresas de Brasil y España. A través de sus proyectos busca el equilibrio entre forma y función, creando un diseño atemporal y sin excesos. Postgrado en dirección de arte y comunicación, también imparte clases en un curso de licenciatura en diseño.

Brazilian graphic and product designer, currently designing lamps and furniture for companies in Brazil and Spain. Through his projects, he seeks the balance between form and functionality, creating timeless designs without excesses. Postgraduate in art direction and communication, he also teaches in a Design Degree course.

Graphiste brésilien et designer de produits, développant actuellement des luminaires et du mobilier pour des entreprises au Brésil et en Espagne. À travers ses projets, il cherche l'équilibre entre la forme et la fonction, créant des designs intemporels sans excès. Diplômé en direction artistique et communication, il enseigne également un cursus de design.





ESTUDI MOLINA

De 1985 a 1989 Manel Molina trabaja como diseñador industrial en el Estudio de Miguel Milà. En 1991 se asocia con Alberto Lievore y Jeannette Altherr y funda el estudio Lievore Altherr Molina. En 2016 crea el ESTUDI MANEL MOLINA junto a Raimon Monsarro, Daniel Castro y Blanca Roigé. Continuando con sus actividades de diseño de mobiliario, producto y asesoría para diferentes empresas.

From 1985 to 1989, Manel Molina worked as an industrial designer at the Miguel Milà Studio. In 1991, he associated with Alberto Lievore and Jeannette Altherr and founded the Lievore Altherr Molina studio. In 2016, he created the ESTUDI MANEL MOLINA together with Raimon Monsarro, Daniel Castro and Blanca Roigé while continuing with his furniture and product design activities and consultancy for different companies.

De 1985 à 1989, Manel Molina a travaillé comme designer industriel au Studio Miguel Milà. En 1991, il s'est associé à Alberto Lievore et Jeannette Altherr et a fondé le studio Lievore Altherr Molina. En 2016, il a créé l'ESTUDI MANEL MOLINA avec Raimon Monsarro, Daniel Castro et Blanca Roigé tout en poursuivant ses activités de conception de meubles et produits, et de conseil pour différentes entreprises.

JORDI VILANOVA

Decorador, interiorista y diseñador. En 1960 es cofundador y miembro del grupo La Cantonada. En 1974 inaugura los locales con exposición permanente de mobiliario, tapicerías, lámparas y alfombras de diseño propio. Introduce los trabajos en madera blanca y es pionero en la creación de un hábitat infantil. Realiza trabajos de interiorismo para establecimientos comerciales, oficinas, escuelas, guarderías, bancos, hospitales y residencias, además de la decoración de pisos y viviendas particulares.

Decorator, interior designer and designer. In 1960, he was co-founder and member of the La Cantonada group. In 1974, he opened some premises with a permanent exhibition of furniture, tapestries, lamps and carpets of his own design. He introduced works with white wood and was a leader in the creation of children homes. He also did interior design work for commercial establishments, offices, schools, nurseries, banks, hospitals and residences, in addition to the decoration of apartments and private houses.

Décorateur, architecte d'intérieur et designer. En 1960, il fut co-fondateur et membre du groupe La Cantonada. En 1974, il a ouvert des lieux pour une exposition permanente de meubles, tapisseries, lampes et tapis de sa propre conception. Il a introduit des œuvres en bois blanc et fut un chef de file dans la création d'habitat pour enfants. Il a réalisé des travaux de design d'intérieur pour des établissements commerciaux, des bureaux, des écoles, des crèches, des banques, des hôpitaux et des résidences, en plus de la décoration d'appartements et de maisons privées.



JOAN ANTONI BLANC

Considerado uno de los pioneros en la aplicación del diseño al desarrollo industrial en España, sus creaciones se caracterizan por su funcionalidad, versatilidad y producción seriada, sin olvidar el contenido social y la sostenibilidad. En 1971 fundó Estudi Blanc junto con Pau Joan Vidal. Joan Antoni Blanc colaboró con instituciones como el FAD, el BCD y el ADP, del que fue director. Algunos de sus diseños fueron galardonados con los Premios Delta de ADI-FAD.

Considered one of the pioneers in the implementation of design to industrial development in Spain, his creations are characterized by their functionality, versatility and serial production, without forgetting their social content and sustainability. In 1971 he founded Estudi Blanc together with Pau Joan Vidal. Joan Antoni Blanc collaborated with institutions such as the FAD, the BCD and the ADP, the latter of which he was director. Some of his designs were awarded with the ADI-FAD Delta Awards.

Considéré comme l'un des pionniers de l'intégration du design au développement industriel en Espagne, ses créations se caractérisent par leur fonctionnalité, leur polyvalence et leur production en série, sans oublier leur contenu social et leur durabilité. En 1971, il a fondé Estudi Blanc avec Pau Joan Vidal. Joan Antoni Blanc a collaboré avec des institutions telles que la FAD, la BCD et l'ADP, dont il a été directeur. Certaines de ses créations ont été récompensées par les ADI-FAD Delta Awards.

BENDITAS STUDIO

Benditas es un estudio de diseño impulsado por la innovación con sede en Barcelona que trabaja en los campos de diseño de producto, dirección de arte y estrategias de diseño. Benditas se fundó en 2019 y busca resolver los problemas del día a día con una visión transversal, interconectando conocimientos, especialidades y sensibilidades.

Benditas is an innovation-driven design studio, based in Barcelona and specialized in product design, art direction and design strategies. Benditas was founded in 2019 and seeks to solve day-to-day design challenges with a transversal vision by interconnecting knowledge, experience and creative sensibility.

Benditas est un studio de design axé sur l'innovation, avec leur siège social à Barcelone où ils travaillent pour différents secteurs de design de produits, direction artistique et stratégies de conception. Benditas a été fondé en 2019 et cherche à apporter des solutions au jour le jour par leur vision transversale mêlant savoir, capacité et sensibilité.





MARIANO CHITARRINI

Estudió arquitectura y siempre le apasionaron los objetos y la luz, eso es lo que le hizo crear su propio estudio de diseño en Barcelona. Su trabajo busca la creación de atmósferas para mejorar la calidad de vida de las personas. Cada diseño es resultado de un depurado proceso de diseño, siempre pensando en el uso funcional y emocional de la lámpara.

He studied architecture and always has been passionate about objects and lights, which led him to open his own design studio in Barcelona. His work creates a coalition between different universes in order to improve the quality of life of people. Each creation is the result of a refined design process taking into account the technical and emotional aspects of the lamp.

Il a étudié l'architecture et a toujours été passionné par les objets et la lumière, ce qui l'a poussé à créer son propre studio à Barcelone. Son travail associe différentes atmosphères pour améliorer la qualité de vie de tous. Chaque création est le résultat d'une analyse de chaque étape de la conception, tout en prenant en compte l'aspect fonctionnel et émotionnel de la lampe.

JAVIER MARTÍNEZ

Pronto se encontró profundamente inmerso en la tradición familiar y a una edad temprana ya estaba dibujando con su padre y montando todo tipo de lámparas. Estudió Diseño y Desarrollo de Producto en la Universidad Politécnica de Cataluña (UPC). Ha colaborado como diseñador y director creativo con diferentes fabricantes de iluminación y estudios de diseño.

At an early age, he was already involved deeply in the family tradition and started drawing and assembling all kinds of lamps with his father. He studied Product Design and Development at the Polytechnic University of Catalonia. He has already worked as a designer and creative director for several lighting manufacturers and design studios.

Depuis très jeune, il a été immergé dans la tradition familiale et réalisait avec son père des croquis et des assemblages de tout type de luminaires. Il a étudié le design et la création de produit à l'Université Polytechnique de Catalogne (UPC). Il a collaboré comme designer et directeur artistique pour de nombreux fabricants d'illumination et studios de design.

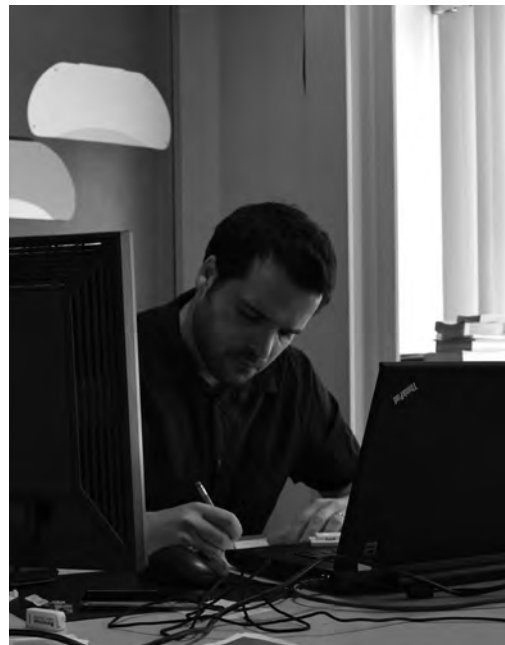

XAVIER DE SANTOS

Diseñador industrial. Cursó estudios de ingeniería técnica mecánica y diseño industrial en Barcelona. Desde 1990 trabaja en diversos estudios de diseño destacando su colaboración con Pascual Salvador estudio de disseny y participando en el diseño de iluminación y mobiliario. Desde 1997 trabaja en Design Center Europe del grupo Volkswagen. Desde 2006 colabora con BMW y AUDI Munich, KIA MOTORS Frankfurt y desde 2017 Geely Design LINK & CO Goteborg.

Industrial designer. He studied mechanical technical engineering and industrial design in Barcelona. Since 1990, he has been working in various design studios, notably collaborated with the design studio Pascual Salvador by participating in lighting and furniture design. Since 1997, he has been working at the Design Center Europe of the Volkswagen group. Since 2006, he has been collaborating with BMW and AUDI Munich, KIA MOTORS Frankfurt and since 2017 Geely Design LINK & CO Goteborg.

Designer industriel. Il a étudié l'ingénierie technique mécanique et le design industriel à Barcelone. Depuis 1990, il a travaillé dans divers studios de design, avec notamment sa collaboration avec Pascual Salvador un studio de design en participant à la conception d'éclairage et de mobilier. Depuis 1997, il travaille au Design Center Europe du groupe Volkswagen. Depuis 2006, il collabore avec BMW et AUDI Munich, KIA MOTORS Francfort et depuis 2017 Geely Design LINK & CO Goteborg.



LONETA NATURAL
NATURAL COTTON
COTON NATUREL

LONETA BLANCA
WHITE COTTON
COTON BLANC

ARPILLERA BEIGE
BEIGE SACKING
TOILE BEIGE

SACO
SACK
JUTE

OSAKA

HUM



COTONET BLANCO
WHITE COTONET
COTONET BLANC

COTONET BEIGE
BEIGE COTONET
COTONET BEIGE

COTONET SAND
SAND COTONET
COTONET SAND

COT. ARENA OSCURA
DARK SAND COT.
COT. SABLE SOMBRE

ARENAL TOPO
TAUPE ARENAL
ARENAL TAUPE

COTONET SIENA
SIENA COTONET
COTONET SIENA

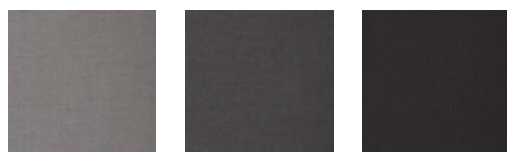

COTONET GRIS FRÍO
COLD GREY COTONET
COTONET GRIS FROID

COTONET PLOMO
LEAD GRAY COTONET
COTONET PLOMB

COT. ANTRACITA
ANTHRACITE COT.
COT. ANTHRACITE



LINO BEIGE
BEIGE LINEN
LIN BEIGE

LINO BLANCO
WHITE LINEN
LIN BLANC

RAFIA
RAFFIA
RAPHIA

MIMBRE NATURAL
NATURAL WICKER
OSIER NATUREL

LAMAS DE MADERA
WOODEN SLATS
LAMES DE BOIS

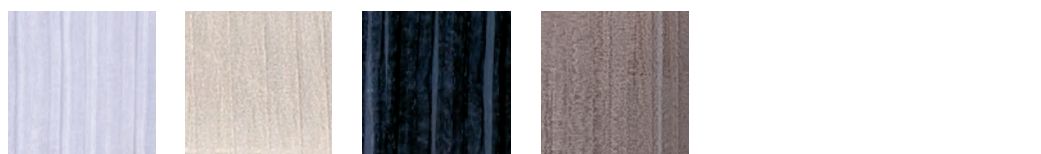

ORGANZA BLANCA
WHITE ORGANZA
ORGANZA BLANCHE

ORGANZA BEIGE
BEIGE ORGANZA
ORGANZA BEIGE

ORGANZA NEGRA
BLACK ORGANZA
ORGANZA NOIR

ORGANZA GRIS
GREY ORGANZA
ORGANZA GRIS



CUERDA EN
ALGODÓN BEIGE
BEIGE COTTON
STRING
CORDE EN
COTON BEIGE

CUERDA EN
ALGODÓN VERDE
GREEN COTTON
STRING
CORDE EN
COTON VERT

CUERDA EN
POLIAMIDA BLANCA
WHITE POLYAMIDE
STRING
CORDE EN
POLYAMIDE BLANC

CUERDA EN
POLIAMIDA NEGRA
BLACK POLYAMIDE
STRING
CORDE EN
POLYAMIDE NOIR



CORCHO CLARO
LIGHT CORK
LIÈGE CLAIR

CORCHO OSCURO
DARK CORK
LIÈGE FONCÉ

CERÁMICA TERRA-
COTA NATURAL
NATURAL CERAMIC
TERRACOTTA
CÉRAMIQUE EN TERRE
CUITE NATURELLE

CERÁMICA ESMALTADA
BLANCA
OFF-WHITE VARNISHED
CERAMIC
CÉRAMIQUE ÉMAILLÉE
BLANCHE



ENCINTADA PONGÉ
PONGEE RIBBON
TISSU PONGÉ

ENCINTADA ALGODÓN
COTTON RIBBON
TISSU COTON



SCREEN BLANCO
WHITE SCREEN
SCREEN BLANC

SCREEN BEIGE
BEIGE SCREEN
SCREEN BEIGE

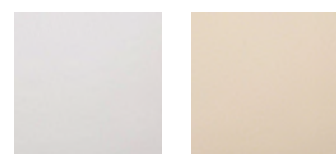

PERGAMINO BLANCO
WHITE PARCHMENT
PARCHEMIN BLANC

PERGAMINO BEIGE
BEIGE PARCHMENT
PARCHEMIN BEIGE



ENCINTADA BLANCA
WHITE RIBBONED
RUBAN BLANCHE

ENCINTADA BEIGE
BEIGE RIBBONED
RUBAN BEIGE

ENCINTADA ROJA
RED RIBBONED
RUBAN ROUGE

ENCINTADA NEGRA
BLACK RIBBONED
RUBAN NOIR



METACRILATO
BLANCO OPAL
OPAL WHITE
METHACRYLATE
METHACRYLATE
OPALE BLANCHE

METACRILATO
VERDE OPAL
OPAL GREEN
METHACRYLATE
METHACRYLATE
OPALE VERT

METACRILATO
GRIS OPAL
OPAL GRAY
METHACRYLATE
METHACRYLATE
OPALE GRIS

METACRILATO
ROJO OPAL
OPAL RED
METHACRYLATE
METHACRYLATE
OPALE ROUGE

luxcambra sl
Alcalde de Móstoles, 50
08025 Barcelona. Spain
T. +34 934 365 953
lux@luxcambra.com

www.luxcambra.com

