

Mesh

Central module

“2 Sides connection”

by Patricia Urquiola

kettal

Central module “2 Sides connection”

Designer
Patricia Urquiola

Collection
Mesh

Reference
KS1700600

1/3

Kettal Mesh collection recalls architectural facades, which filter the surrounding environment without stopping the light and air flow. Industrial and natural materials, hard and soft surfaces, transparent and solid volumes are putted face to face in order to create this family of outdoor furniture based in contrasts.

cm/inch

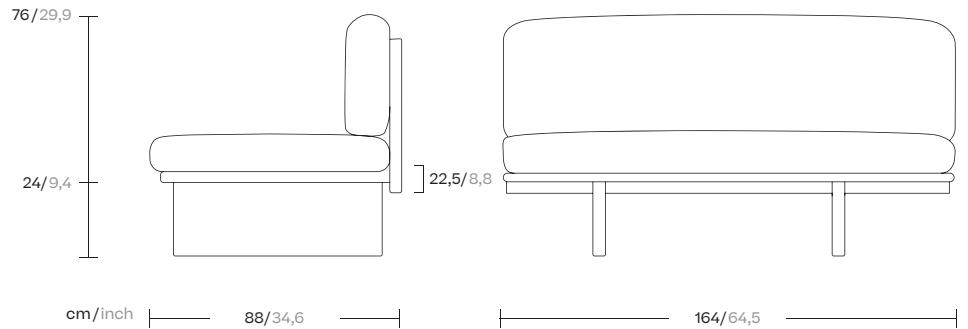

kettal

Central module “2 Sides connection”

Designer
Patricia Urquiola

Collection
Mesh

Reference
KS1700600

2/3

Materials

Aluminium
Antioxy, Heavy Load, Resistant En-1421, Kettalize-It, Anti-Scratch, Easy Clean, Flame Retardant M1, Eco Friendly Ecoembes Recycling Process

Teak
Eco-friendly, A-grade, Heavy Load

Fabric
Heavy Load, 100.000 Cycles, Heavy Load Resistant 1000 Decitex, Kettalize-It, Resist U.V. En-581-4, Easy Clean, Abrasion, Resistance 30.000 Cycles, Quickdry

Maintenance

Clean with mild soap using sponge or cloth. Be gentle while cleaning, do not scrub aggressively the fabric. Once cleaned please make sure you remove soap excess.

In case of aggressive stains clean with diluted household bleach.

Clean stains promptly. The longer it remains, more difficult will be to remove.

Once cleaned the fabric steam iron the fabric. Just use steam, be carefull NOT placing the iron directly in the fabric it will get damage.

Frame Colour Options



Chalk
721



Bone
678



Tuff
103



Mist
773



Flint
734



London Clay
729



Mahogany
100



Carbon
737



Lilac
104



Feldspar
082



Sepia
088



Terra Rossa
087

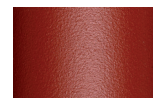

Magma
086



Terracota
085



Sahara
139

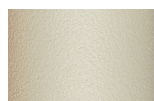

Camomile
106



Aquamarine
107



Cobalt
089



Indigo
094



Jade
091



Onyx
101



Juniper
092



Amazon
102



Bronze
093



Corten
727



Claystone
741

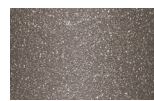

Sand Storm
132



Pumice
131



Galena
105



Manganese
726

Frame Colour Options



Teak
904

Other

Central module “2 Sides connection”

Designer
Patricia Urquiola

Collection
Mesh

Reference
KS1700600

3/3

Seat/Back Cushion

Terrain Laminate Fabrics

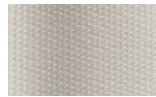

White Cliffs
290



Dry Sand
285

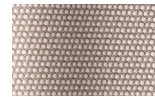

Porous Grey
291

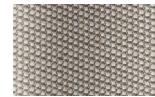

Limestone
292



Fog
289



Deer
286



Wet Sand
287



Cobblestone
302



Cyprus Umber
301



Loam
297



Charcoal
293



Arctic
295

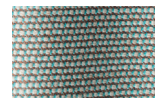

Fjord
248



Cerulean
314



Caribbean
298



Atlantic
311



Rainforest
312



Lagoon
249



Cedar
288



Moss
296



Olive
313



Autumn
315

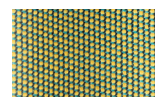

Summer Sky
317

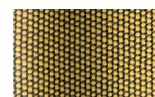

Golden Sand
303



Flamma
304



Sunrise
299



Saffron
305



Burnt Sienna
306

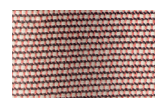

Ash Rose
294

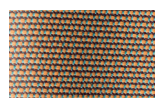

Cooper
316

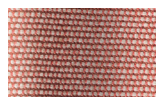

Dusk Pink
307

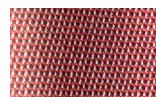

Flamingo
310



Coral
309

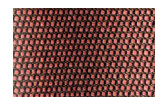

Sandstone
308