

indoor

Altet

Upholstered dining armchair / sillón comedor tapizado

Studio expormim, 2012/2021

T111 U



Dining armchair with structure made of peeled and tinted natural rattan of 1.18" diameter. Backrest manufactured in peeled and tinted natural rattan of 0.3" diameter. Finished with a three step water-based coating (dye, base coat and top coat) highly resistant to solar radiation thanks to UV filters. Upholstered seat. Possibility of customization through a wide variety of high performance technical fabrics. Protective caps.

Sillón de comedor con estructura en rattan natural pelado y tintado de 30 mm de calibre. Respaldo fabricado en rattan natural pelado y tintado de 8 mm de calibre. Acabado con recubrimiento en tres fases (tinte, fondo y acabado) con filtros UV que lo hacen altamente resistente a la radiación solar. Los acabados utilizados son en base al agua. Asiento tapizado. Posibilidad de personalización mediante una amplia variedad de tejidos técnicos de altas prestaciones de uso. Tacos protectores.

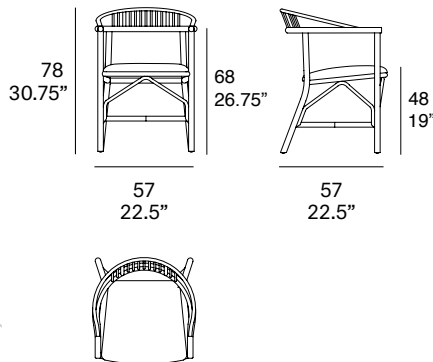

Shipment details

Qty	1 dining armchair (1 box)
Volume	0,29 m ³ / 10 ft ³
Gross weight	10,5 kg / 23 lb
Net weight	6,5 kg / 14.5 lb
Box dimensions (approx.)	58 x 59 x 80 cm 22.75" x 23.25" x 31.5"
Item dimensions (width x depth x height)	57 x 57 x 78 cm 22.5" x 22.5" x 30.75"
COM (1, 40 - 1,50 m / 54"-59")	cushion: 0,65 m / 0.71 yd

Certifications

EN 1728:2013
EN 16139:2013 (level: L1)
EN 1022:2005

expormim

Expormim S.A.
Pol. Ind. Jaime I
46640 Moixent (Valencia) Spain
+34 962 295 144/5
export@expormim.com
www.expormim.com

Expormim USA LLC
(212) 204-8572
usa@expormim.com
www.expormim.com

1/7

Rattan

Natural_matt



R10 natural

Tinted_matt



R30 oak



R03 noce



R05 grigio



R23 french grey



R06 verde oliva



R08 azzurro



R09 nero

Tinted_gloss



R31 cognac



R32 antique brown



R33 alpine green

Lacquered_matt



R02 bianco



R22 clay



R14 japanese red



indoor

Cushions / confección

group 31 - dolce Crevin®

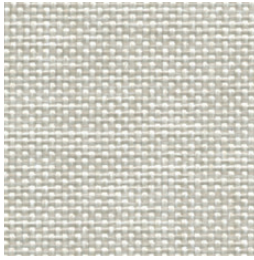

dolce 07

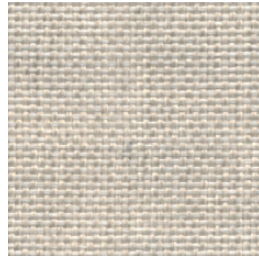

dolce 04

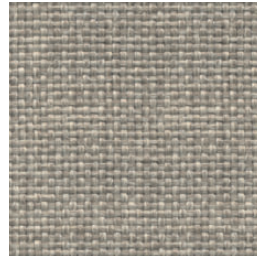

dolce 11

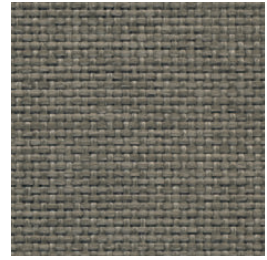

dolce 12



dolce 53

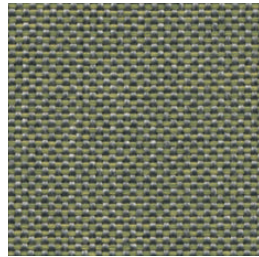

dolce 30

group 31 - ito Crevin®



ito 05

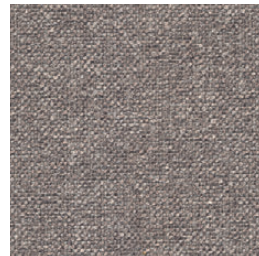

ito 18



ito 12

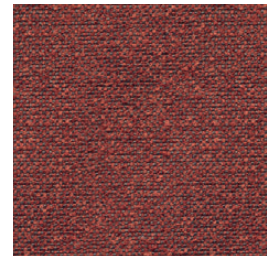

ito 21



ito 20



ito 38



ito 45

indoor

Cushions / confección

group 31 - salvia Crevin®



salvia 02



salvia 20

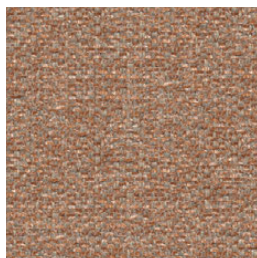

salvia 29

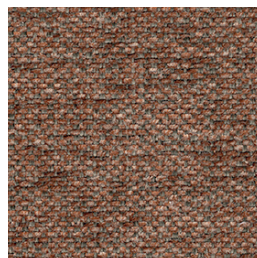

salvia 21



salvia 38

group 31 - sacco Crevin®



sacco 02



sacco 05

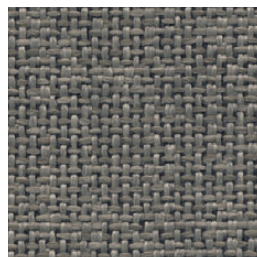

sacco 11

group 31 - valencia™ C5 heritage faux leather



valencia heritage 9050



valencia heritage 9051

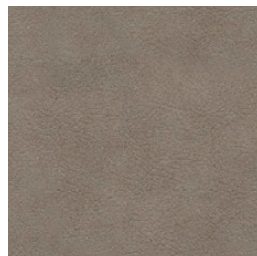

valencia heritage 9052



valencia heritage 9055

indoor

Cushions / confección

group 32 - velvety Crevin®



velvety 10



velvety 17

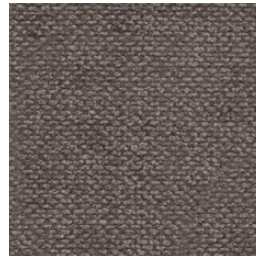

velvety 12



velvety 26

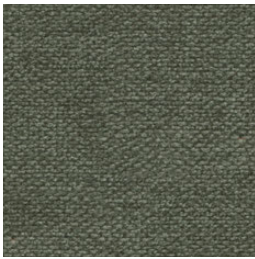

velvety 32

group 32 - indianskop Limonta



indianskop 15



indianskop 02



indianskop 04



indianskop 31



indianskop 46

expormim

Expormim S.A.
Pol. Ind. Jaime I
46640 Moixent (Valencia) Spain
+34 962 295 144/5
export@expormim.com
www.expormim.com

Expormim USA LLC
(212) 204-8572
usa@expormim.com
www.expormim.com

5/7

indoor

Cushions / confección

group 32 - clusone Limonta



clusone 04



clusone 06



clusone 05



clusone 10



clusone 16

group 32 - ascendent reloaded Carlucci®



ascendent reloaded 094

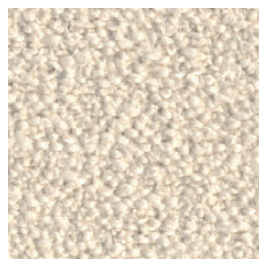

ascendent reloaded 070



ascendent reloaded 071



ascendent reloaded 030

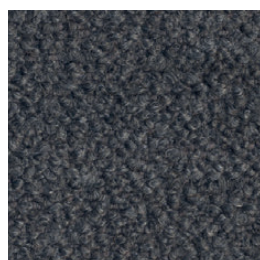

ascendent reloaded 093



ascendent reloaded 022



ascendent reloaded 040

indoor

Cushions / confección

group 33 - elmosoft Elmo® leather

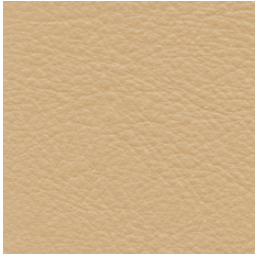

elmosoft 22024



elmosoft 33004

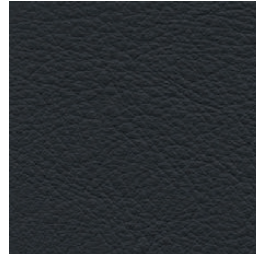

elmosoft 99999