

Giro
Centre table Ø90,
by Vincent Van Duysen

kettal

Centre table Ø90

Designer
Vincent Van Duysen

Collection
Giro

Reference
KS7401200

1/2

Giro is a collection which can blend into interiors and exteriors due to its tactility and pure lines. In Giro, we have some variety of shapes, textures and materials (see the difference between the seating items and the coffee and side tables). And still all the items merge harmoniously together to create a warm, tactile and pleasant atmosphere.

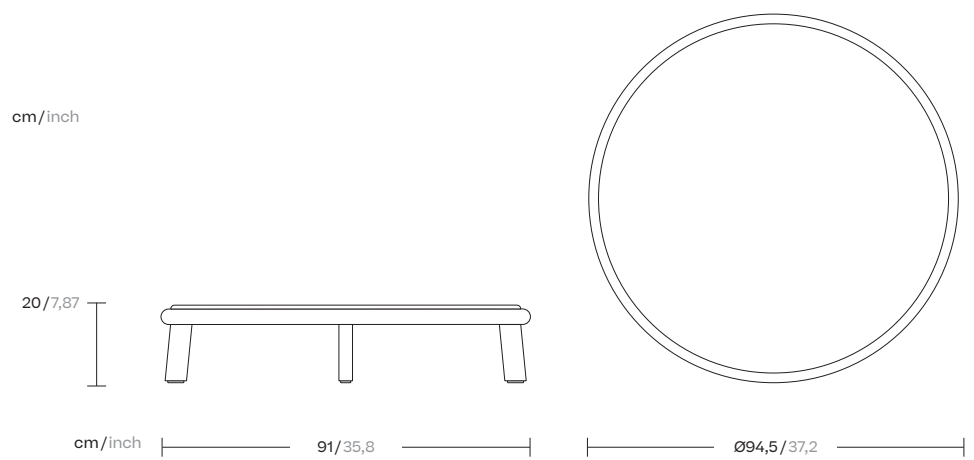

kettal

Centre table Ø90

Designer
Vincent Van Duysen

Collection
Giro

Reference
KS7401200

2/2

Materials

Teak
Teak A-Grade, Eco Friendly
Oeko-Tek

Ceramics

Base Colour Options

Teak



Teak



Cinnamon
Teak

Table Top Colour Options

Ceramics



Du Gent Grey
CM2



Neutral Caliza
CM3

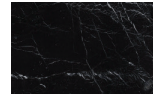

Royal Black
CM4

Maintenance

Clean with mild soap using sponge or cloth. Be gentle while cleaning, do not scrub aggressively the fabric. Once cleaned please make sure you remove soap excess.

In case of aggressive stains clean with diluted household bleach.

Clean stains promptly. The longer it remains, more difficult will be to remove.

Once cleaned the fabric steam iron the fabric. Just use steam, be carefull NOT placing the iron directly in the fabric it will get damage.