

indoor

Cask indoor

Round daybed / cama redonda

Norm Architects, 2021/2024

T099



Round daybed with structure made of peeled and tinted natural rattan of 34 mm/1.34" diameter. Backrest manufactured in peeled and tinted natural rattan of 20 mm/0.79" diameter. Finished with a three step water-based coating (dye, base coat and top coat) highly resistant to solar radiation thanks to UV filters. Possibility of customization through a wide variety of fabrics. Protective caps. 3 loose cushions 45x45 cm/17.75"x 17.75" included.

Cama redonda con estructura en rattan natural pelado y tintado de 34 mm de calibre. Respaldo fabricado en rattan natural pelado y tintado de 20 mm de calibre. Acabado con recubrimiento en tres fases (tinte, fondo y acabado) con filtros UV que lo hacen altamente resistente a la radiación solar. Los acabados utilizados son en base al agua. Posibilidad de personalización mediante una amplia variedad de tejidos. Tacos protectores. 3 cojines decorativos de 45x45 cm incluidos.

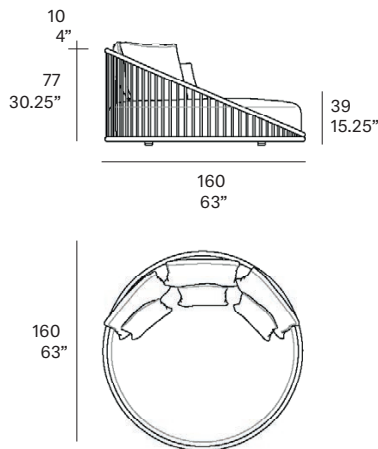

Shipment details

Qty	1 daybed (1 box)
Volume	2,23 m3 / 78.5 ft3
Gross weight	74 kg / 163.2 lb
Net weight	62 kg / 136.7 lb
Box dimensions (approx.)	165 x 165 x 83 cm 65" x 65" x 32.5"
Item dimensions (width x depth x height)	160 x 160 x 78 cm 63" x 63" x 30.7"
COM	seat cushion: 8,1 m / 8.8 yd loose cushions: 1,5 m / 1.6 yd

expormim

Expormim S.A.
Pol. Ind. Jaime I
46640 Moixent (Valencia) Spain
+34 962 295 144/5
export@expormim.com
www.expormim.com

Expormim USA LLC
(212) 204-8572
usa@expormim.com
www.expormim.com

1/6

Rattan

Natural_matt



R10 natural

Tinted_matt



R30 oak



R03 noce



R05 grigio



R23 french grey



R06 verde oliva



R08 azzurro



R09 nero

Tinted_gloss



R31 cognac



R32 antique brown



R33 alpine green

Lacquered_matt



R02 bianco



R22 clay



R14 japanese red



indoor

Cushions / confección

group 31 - dolce Crevin®

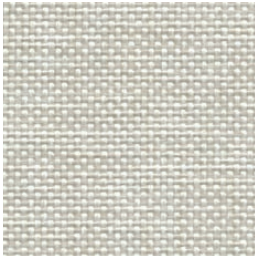

dolce 07

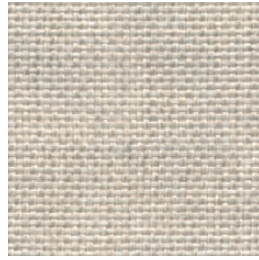

dolce 04

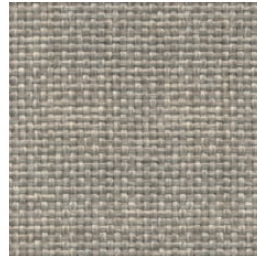

dolce 11



dolce 12

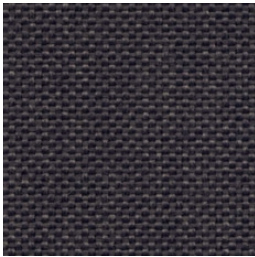

dolce 53



dolce 30

group 31 - ito Crevin®



ito 05



ito 18



ito 12



ito 21



ito 20



ito 38



ito 45

indoor

Cushions / confección

group 31 - salvia Crevin®



salvia 02

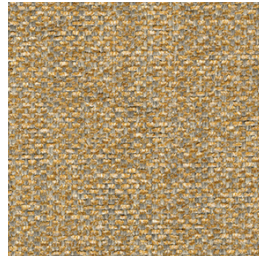

salvia 20



salvia 29

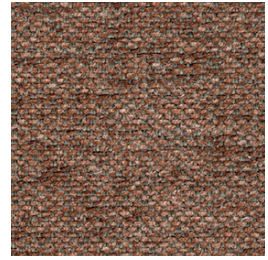

salvia 21



salvia 38

group 31 - sacco Crevin®



sacco 02



sacco 05

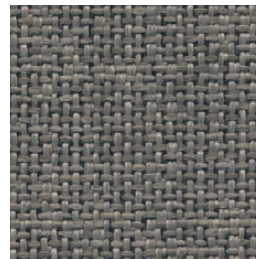

sacco 11

group 31 - valencia™ C5 heritage faux leather



valencia heritage 9050



valencia heritage 9051



valencia heritage 9052

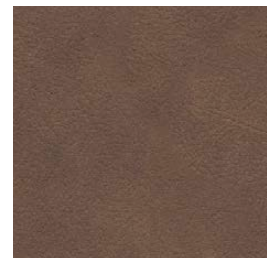

valencia heritage 9055

indoor

Cushions / confección

group 32 - velvety Crevin®



velvety 10



velvety 17

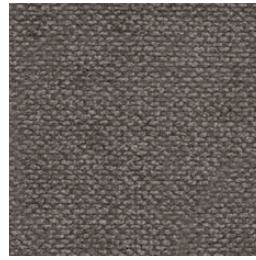

velvety 12



velvety 26



velvety 32

group 32 - indianskop Limonta



indianskop 15



indianskop 02



indianskop 04



indianskop 31



indianskop 46

expormim

Expormim S.A.
Pol. Ind. Jaime I
46640 Moixent (Valencia) Spain
+34 962 295 144/5
export@expormim.com
www.expormim.com

Expormim USA LLC
(212) 204-8572
usa@expormim.com
www.expormim.com

5/6

indoor

Cushions / confección

group 32 - clusone Limonta



clusone 04

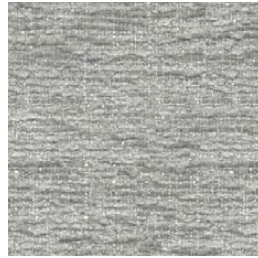

clusone 06



clusone 05



clusone 10



clusone 16

group 32 - ascendent reloaded Carlucci®

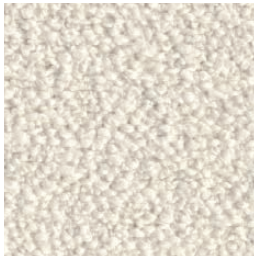

ascendent reloaded 094



ascendent reloaded 070



ascendent reloaded 071

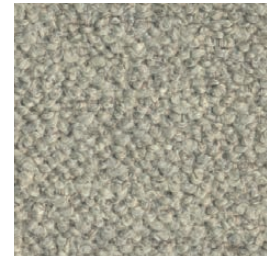

ascendent reloaded 030



ascendent reloaded 093



ascendent reloaded 022



ascendent reloaded 040