

ARCHITECTURAL



F A R O
BARCELONA



Edition

A2025ARCH

Art direction and design

Faro Art

All Rights Reserved

Reproduction without written permission from the publisher is strictly prohibited.

Architectural Collection

Tracklights	25
Downlights	75
Surface	281
Suspended	367
Systems	391
Ledstrip	469
Connectivity	484
Drivers	490



Tracklights

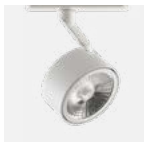

Target
27



Fost
39



Blit
51



Via
59

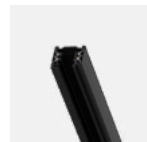

Tracks
68

Downlights



Elios
77



Alia
103



Izar
111



Tulipa
119

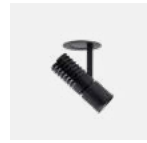

Uno
131



Kope
141



Deep
149



Teide
247



Podium
259



Backlight
273

Surface



Troop
283



Blit
295



Scuba
303



Proofline
313



Fost Surface
321



Fost Ceiling
331



Domio
341

Suspended



Mute
369



Fost
379



Fonovia
457

Systems



Neso
395

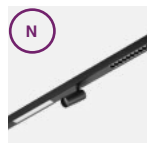

Neso Slim
416



Via Evo
433



Fonovia
464

Ledstrip

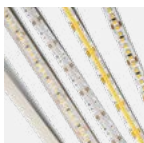

Ledstrip
469



Troop
165

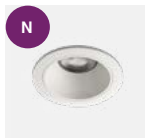

Kimo
179



Kobo
187



Croc
195



Optic
205



Colin
213



**Fost
Recessed**
227



**Fost
Pulldown**
237



Podium

355



DESIGN FOR EVERYONE

BRAND WITH SOUL

Our purpose is to contribute to the wellbeing and happiness of people through design and the relationship we establish with the objects that surround us in our daily lives. We believe in honest and accessible design.

Nuestra razón de ser es contribuir al bienestar y la felicidad de las personas a través del diseño y la relación que establecemos con los objetos que nos acompañan en nuestro día a día. Creemos en un diseño honesto, accesible y cercano.



TURN OFF THE LIGHT

Our sustainability journey focuses on minimizing our environmental footprint and maximizing our positive impact on society.

Nuestro camino hacia la sostenibilidad se centra en reducir nuestro impacto negativo en el planeta y maximizar nuestro impacto social positivo.



Find out more
Descubre más





YOUR IDEA, OUR EXPERTISE

The expertise and knowledge of our professionals are dedicated to bringing your ideas to life, creating unique and functional spaces.

La experiencia y el conocimiento de nuestros profesionales se ponen al servicio de tus ideas para crear espacios únicos y funcionales.

Parametrical Lab

Specification Compliance
Electrical Safety Tests
Integrating Sphere
Climatic Chamber
IK Tests
Endurance Test Room
Thermal Test Room

Environmental Testing Lab

Water IP Tests
Powder IP Tests
Salt Spray Chamber

Technical Assistance Service (TAS)

Customer Returns Analysis
Customer Returns Repairs
TAS Spare Parts

Quality inspections Lab

Batch inspections
Functional Tests
Product Assembly Control
Product Finish Control

Ceiling Fan Lab

Life Test
Customizations
Airflow measurements
Noise measurements

Goniophotometer Room



QUALITY COMMITMENT

Our commitment to quality is at the heart of everything we design. We rigorously control the quality of our products and services from conception to functionality and reliability testing.

Nuestro compromiso con la calidad está presente en todo lo que diseñamos. Controlamos rigurosamente la calidad de nuestros productos y servicios desde la concepción hasta los ensayos de funcionalidad y fiabilidad.

Quality management system based on ISO9001.

Compliance with electrical safety regulations under EN60598 and energy efficiency ERP.

Sistema de gestión de calidad basado en la ISO9001.

Cumplimiento legislativo de las normativas de seguridad bajo la EN60598 y la normativa de eficiencia energética ERP.

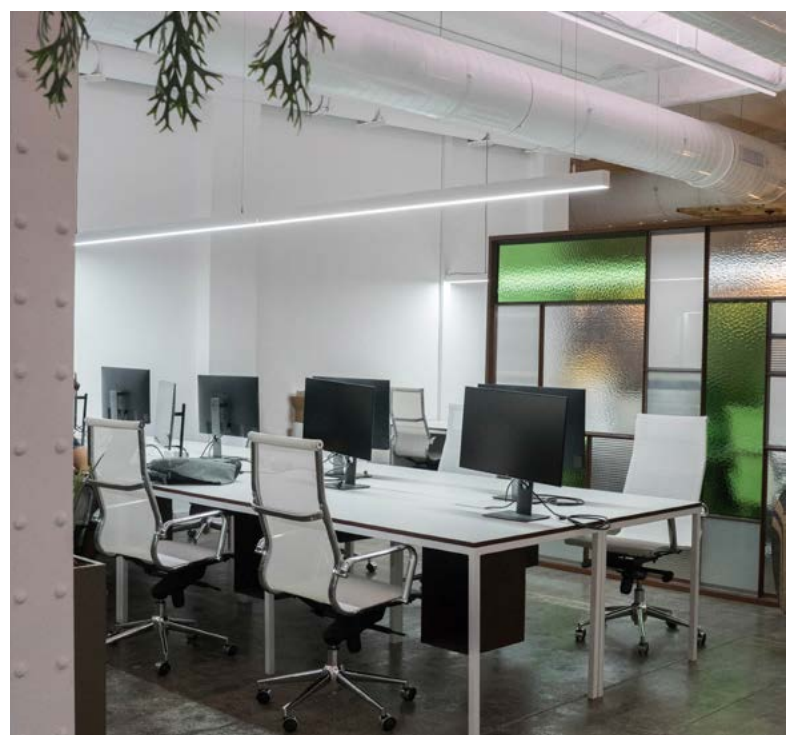
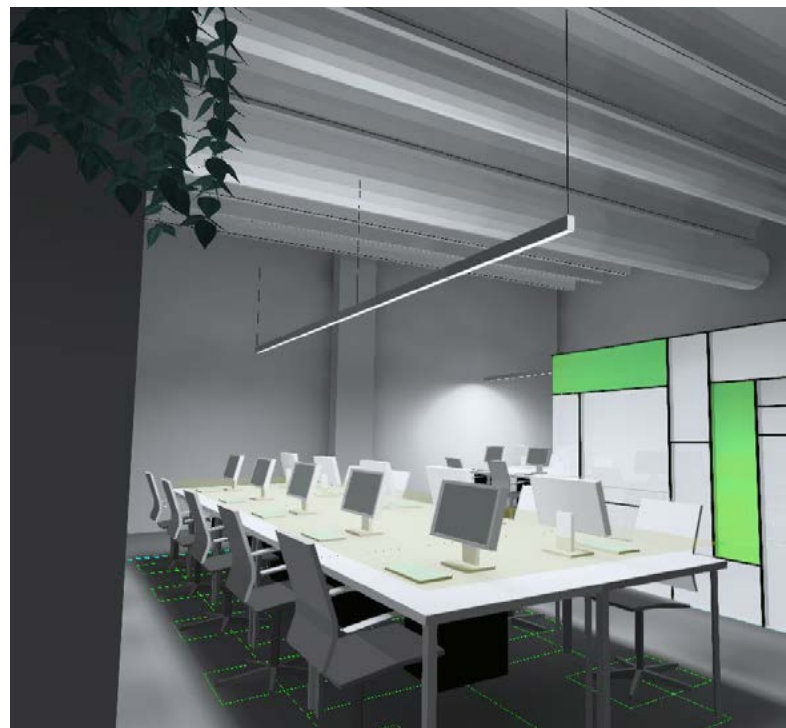

LIGHTING PROJECTS



Need consulting for your project?
¿Necesitas asesoramiento para tu proyecto?

At Faro Barcelona, our expert team in lighting and interior design supports you at every stage of your projects, from needs interpretation and calculations to implementation. We provide personalized advice and thorough follow-up, focusing on environmental care, architectural enhancement, and aesthetic trends.

En Faro Barcelona contamos con un equipo experto en iluminación e interiorismo que te acompaña en cada etapa de tus proyectos, desde la interpretación de necesidades y cálculos hasta la implementación. Ofrecemos asesoría personalizada y seguimiento completo, cuidando el entorno, realzando la arquitectura y siguiendo las tendencias estéticas..

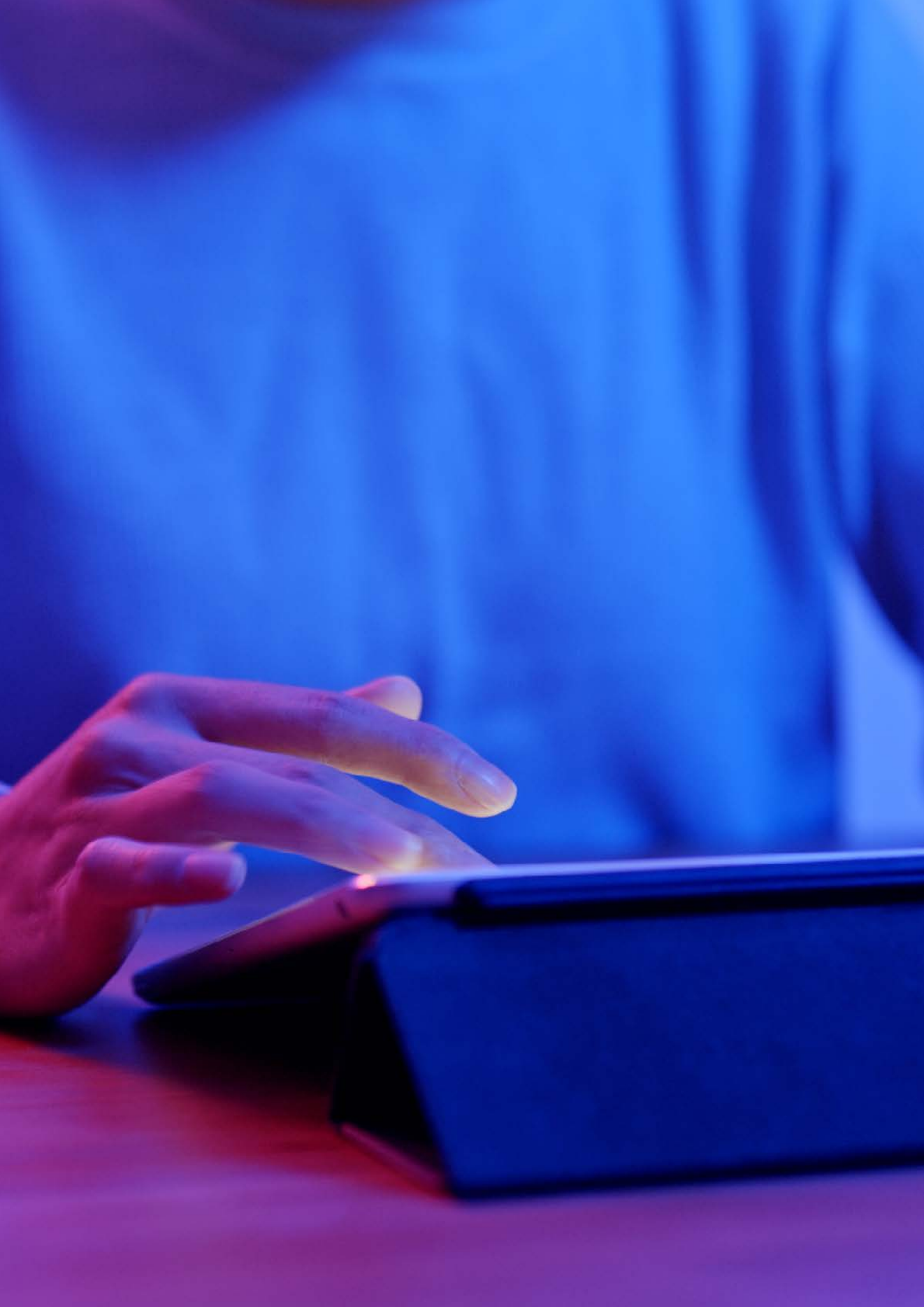

CONTROL & CONNECTIVITY

At Faro Barcelona, we design high-quality lighting solutions with control, connectivity, and customization to fit each space. Our approach enhances well-being by providing flexibility, energy efficiency, and sustainable experiences. En Faro Barcelona diseñamos soluciones de iluminación de calidad, con control, conectividad y personalización, para adaptarse a cada espacio. Nuestro enfoque busca mejorar el bienestar, ofreciendo flexibilidad, eficiencia energética y experiencias sostenibles.



INTEGRATIVE LIGHTING

At Faro Barcelona, we create Human Centric Lighting (HCL) solutions that synchronize artificial light with the circadian cycle, enhancing physical and emotional well-being, sleep, and efficiency, fostering holistic and balanced health.

En Faro Barcelona desarrollamos soluciones de Human Centric Lighting (HCL) que sincronizan la luz artificial con el ciclo circadiano, mejorando el bienestar físico y emocional, el sueño y la eficiencia, promoviendo una salud integral y equilibrada.

Note: Our luminaires with **Tunable White (TW)** technology offer this capability, adapting to the needs of each moment of the day.

Nota: Nuestras luminarias con tecnología **Tunable White (TW)** ofrecen esta posibilidad, adaptándose a las necesidades de cada momento del día.



ILUMINACIÓN SALUDABLE

HEALTHY LIGHTING

At Faro Barcelona, we design luminaires that prioritize health and comfort, offering stable lighting, high CRI for accurate colors, and low UGR to reduce glare. Our designs meet photobiological safety standards, ensuring a safe and comfortable visual experience.

En Faro Barcelona diseñamos luminarias que cuidan la salud y el confort, con iluminación estable, alto CRI para colores reales y bajo UGR para minimizar el deslumbramiento. Cumplimos estándares de seguridad fotobiológica, asegurando una experiencia visual segura y cómoda.



PROMOTES WELL-BEING
PROMUEVE EL BIENESTAR

Thrive reduces excessive blue light, supporting the **circadian rhythm**, better sleep, and improved mood.
Thrive reduce la luz azul excesiva, favoreciendo el **ritmo circadiano**, un sueño más reparador y mejorando el ánimo.

LOWER ASD
MENOR ASD

Thrive technology offers an ASD of 9%, compared to 18% in high-quality LEDs (CRI 98), delivering light closer to natural and a more comfortable visual experience.
La tecnología Thrive tiene un ASD del 9%, frente al 18% de los LEDs de alta calidad (CRI 98), logrando una luz más similar a la natural y una experiencia visual más cómoda.

REDUCTION OF HARMFUL BLUE LIGHT
REDUCCIÓN DE LUZ AZUL NOCIVA

Thrive smooths blue light peaks, protecting eye health and circadian rhythms.
Thrive suaviza los picos de luz azul, cuidando la salud ocular y los ritmos circadianos.

COMMON APPLICATIONS
APLICACIONES COMUNES

Thrive is perfect for spaces needing quality light and comfort: fashion stores, offices, schools, and healthcare settings.
Thrive es ideal para espacios que requieren luz de calidad y confort: tiendas de moda, oficinas, escuelas y entornos sanitarios.

THRIVE TECHNOLOGY

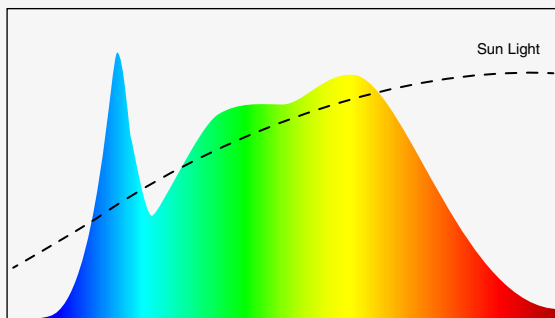

CRI 90 LED (ASD 19%)

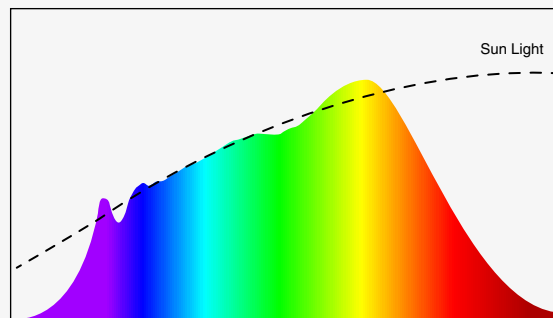

THRIVE LED (ASD 8%)

Human beings evolved under sunlight and fire, adapting to their natural spectrums. Thrive technology recreates this light with an artificial spectrum that is as close to sunlight as possible, promoting biological balance and a healthier, more productive visual environment, ideal for everyday well-being. Los seres humanos hemos evolucionado bajo la luz natural del sol y el fuego, adaptándonos a sus espectros.

La tecnología Thrive recrea esta luz con un espectro artificial lo más parecido posible al del sol, promoviendo el equilibrio biológico y un entorno visual más saludable y productivo, ideal para el bienestar diario.

T R A C K I

L I G H T S

Less is more. The design of the TARGET track projector achieves the minimum expression of visual volume, making the place appear spacious and bringing the architecture and the elements to be lit to the forefront. Its wide range of colour temperature, different optics and high CRI options makes it a perfect option for commercial spaces, hotels, restaurants and retail.

Menos es más. El diseño del proyector a carril TARGET logra la mínima expresión del volumen visual, dotando de amplitud al lugar y cediendo el protagonismo a la arquitectura y los elementos a iluminar. Su amplia gama de temperaturas de color, diversas ópticas y opciones de alto IRC lo convierten en una opción perfecta para espacios comerciales, hoteles, restauración y retail.



TARGET





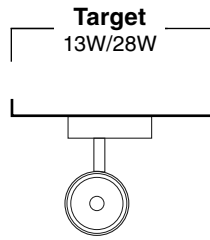

ø110

FINISH
Acabado

● **Black**
Negro

○ **White**
Blanco

COLOR TEMPERATURE
Temperatura de color

2700K CRI90

3000K CRI90

4000K CRI90

2700K CRI97

3000K CRI97

4000K CRI97

MEAT

BREAD

FASHION

BEAM ANGLE
Ángulo de apertura

15°

35°

ACCESSORIES
Accesorios



Honeycomb



Striped Glass



Long Snoot

CONTROL SYSTEM
Sistema de control



CASAMBI

Highlights



Accessory



Honeycomb



Long Snout



Striped Glass



Built-in track
Equipo built-in en adaptador



High CRI
Alto IRC



Several color temperatures
Varias temperaturas de color





Honeycomb



Long Snoot



Striped Glass



Striped Glass

Accessories

Honeycomb	Long Snoot	Striped Glass
● 011400098		● 011400097
● 011400096	● 011400099	● 011400095



Restaurant

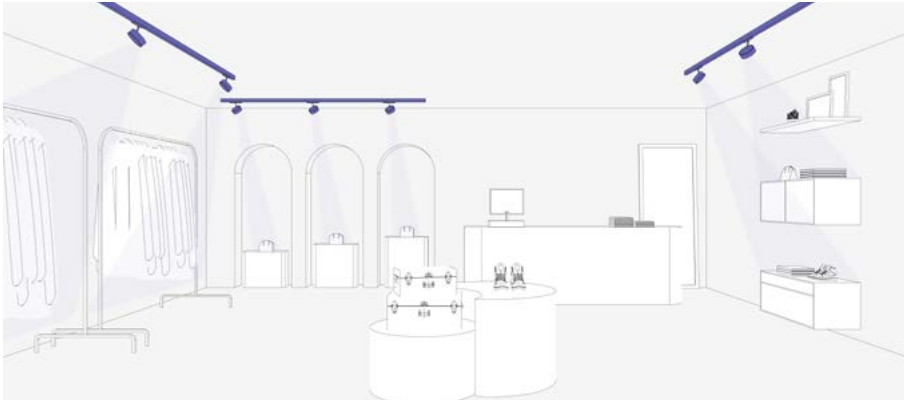

Retail

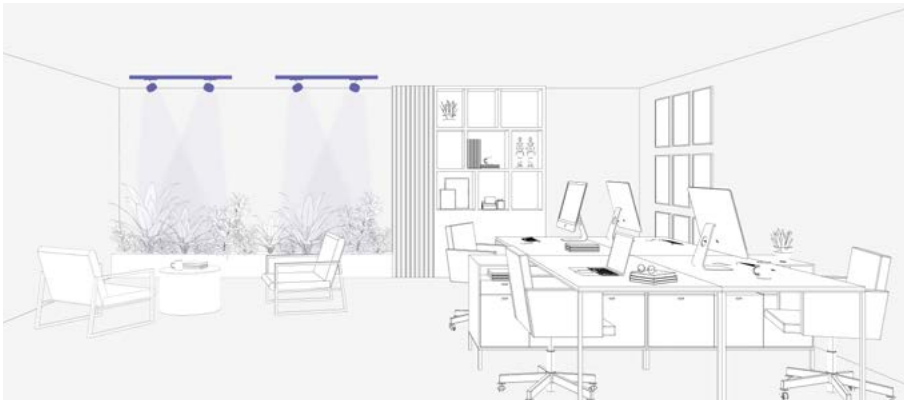

Office

Beam Angle



15°



35°

TARGET 13W

incl. DIM 355° 90° 50.000hs L70 / B10 MacAdam 2&3 220-240V 50 / 60Hz 650°C

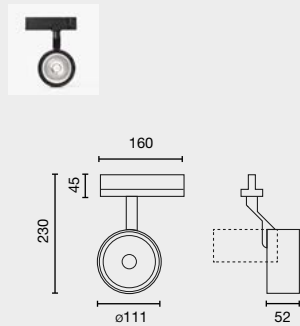

Family	Color T°	Beam Angle	Finish	Control System
0214 Target 13W	927 2700K CRI90	1 15° 3 35°	1 White	W CASAMBI D DALI ON/OFF
	930 3000K CRI90		2 Black	
	940 4000K CRI90			
	X27 2700K CRI97			
	X30 3000K CRI97			
	X40 4000K CRI97			
	MT MEAT			
	BR BREAD			
FS FASHION				

0214 927 1 1 W

Example **021492711W** — Target13W 2700K CRI90 15° White Casambi

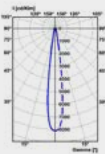

15°

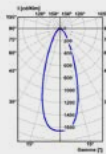

35°

Option	Color T°	CRI	Power	Lumen Output	Beam Angle
927	2700K	90	13W	970 / 1048lm	15° / 35°
x27		97	13W	872 / 943lm	15° / 35°
930	3000K	90	13W	1000 / 1080lm	15° / 35°
x30		97	13W	900 / 972lm	15° / 35°
940	4000K	90	13W	1029 / 1113lm	15° / 35°
x40		97	13W	927 / 1001lm	15° / 35°
MT	3100K	-	13W	1143 / 1226lm	15° / 35°
BR	2500K	-	13W	847 / 909lm	15° / 35°
FS	3100K	-	13W	1168 / 1253lm	15° / 35°
LF	2700K	-	13W	665 / 693lm	15° / 35°



TARGET 28W

incl. DIM 355° 90° 50.000hs L70 / B10 MacAdam 2&3 220-240V 50 / 60Hz 650°C

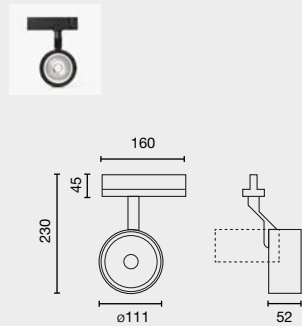

Family	Color T°	Beam Angle	Finish	Control System
0114 Target 28W	927 2700K CRI90	1 15°	1 White	W CASAMBI
	930 3000K CRI90	3 35°	2 Black	D DALI
	940 4000K CRI90			ON/OFF
	X27 2700K CRI97			
	X30 3000K CRI97			
	X40 4000K CRI97			
	MT MEAT			
	BR BREAD			
	FS FASHION			

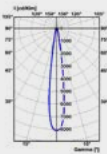

15°

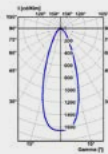

35°

Option	Color T°	CRI	Power	Lumen Output	Beam Angle
927	2700K	90	28W	2311lm / 2157lm	15° / 35°
X27	2700K	97	28W	2079lm / 1941lm	15° / 35°
930	3000K	90	28W	2382lm / 2224lm	15° / 35°
X30	3000K	97	28W	2144lm / 2001lm	15° / 35°
940	4000K	90	28W	2453lm / 2291lm	15° / 35°
X40	4000K	97	28W	2208lm / 2061lm	15° / 35°
MT	3100K	-	28W	2723lm / 2523lm	15° / 35°
BR	2500K	-	28W	2018lm / 1871lm	15° / 35°
FS	3100K	-	28W	2783lm / 2579lm	15° / 35°
LF	2700K	-	28W	1584lm / 1426lm	15° / 35°



The FOST TRACK family of track projectors was born to meet the need to accentuate what needs to be highlighted. A minimalist design that is easy to integrate into any space, bringing the architecture to the forefront. The location of the driver in the actual track adaptor facilitates this integration.

La familia de proyectores a carril FOST TRACK nace para dar respuesta a la necesidad de poner acento a lo que debe ser destacado. Un diseño minimalista de fácil integración en cualquier espacio dando protagonismo a la arquitectura. La ubicación del driver en el propio adaptador a carril facilita esta integración.



FOST



TRACK



FOST Collection



Recessed
227



Pulldown
237



Ceiling
331



Surface
321



Pendant
379

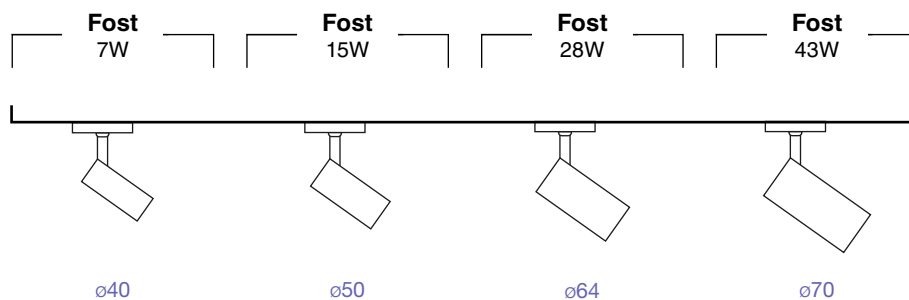

FINISH
Acabado

● **Black**
Negro

○ **White**
Blanco

COLOR TEMPERATURE
Temperatura de color

2700K CRI90	3000K CRI90	4000K CRI90
2700K CRI97	3000K CRI97	4000K CRI97
MEAT	BREAD	FASHION

BEAM ANGLE
Ángulo de apertura

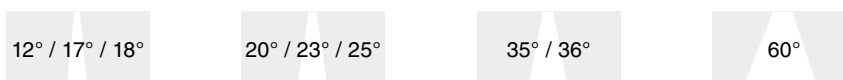

ACCESSORIES
Accesorios

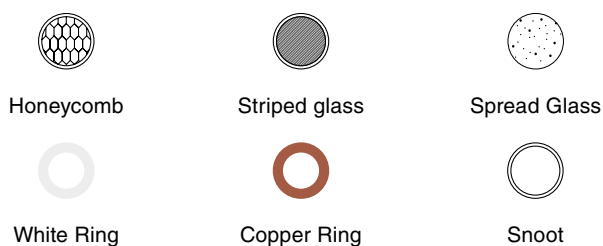

CONTROL SYSTEM
Sistema de control



CASAMBI



Highlights



Its versatility of sizes and optics makes it an ideal solution for commercial spaces, hotels, restaurants, retail and even domestic spaces due to its colour temperature and CRI options.

Su versatilidad en tamaños y ópticas lo convierten en una solución ideal para espacios comerciales, hoteles, restaurantes, retail e incluso espacios domésticos por sus opciones en temperatura de color y IRC.



Different sizes
Diversos tamaños



Built-in track
Equipo built-in en adaptador



High CRI
Alto IRC



Several color temperatures
Varias temperaturas de color





White Ring



Copper Ring



Striped Glass



Long Snoot

Its multiple accessories and combinations facilitate the product's personalisation, giving it certain architectural relevance and at the same time making it possible to modify the beam or reduce glare.

Sus múltiples accesorios y combinaciones facilitan la personalización del producto que hace posible la modificación de haz o reducir el deslumbramiento.



Spread Glass



Honeycomb



Without accessory



Spread Glass



Striped Glass

Accesorios

	Honeycomb	White Ring	Copper Ring	Spread Glass	Long Snoot	Striped Glass
ø40	-	011500099	011500098	-	-	-
ø50	-	011600099	011600098	-	-	-
ø64	011700094	011700099	011700098	011700097	011700095	011700096
ø70	011800094	011800099	011800098	011800097	011800095	011800096



Restaurant

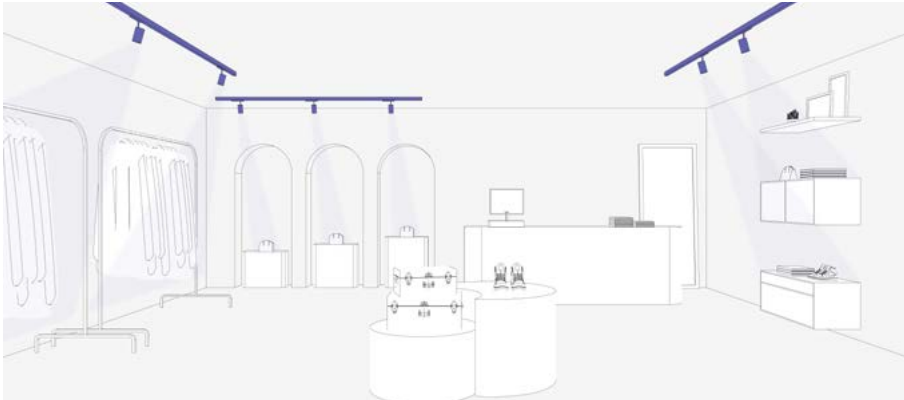

Retail

Beam Angle

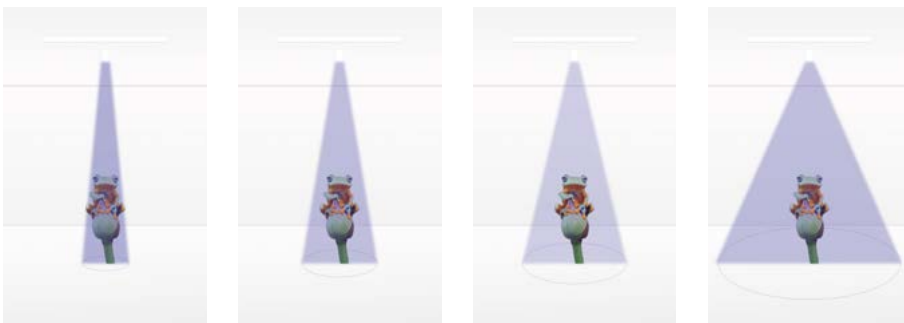

12/17/18°

20/23/25°

35/36°

60°

FOST TRACK 40

incl. DIM 355° 90° 50.000hs L70 / B10 MacAdam 2&3 220-240V 50 / 60Hz 650°C

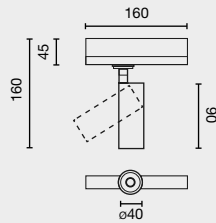

Family	Color T°	Beam Angle	Finish	Control System						
0115 Fost Track ø40 7W	927 2700K CRI90	1 18°	1 White	<table border="1"> <tr><td>W</td><td>CASAMBI</td></tr> <tr><td>D</td><td>DALI</td></tr> <tr><td></td><td>ON/OFF</td></tr> </table>	W	CASAMBI	D	DALI		ON/OFF
	W	CASAMBI								
	D	DALI								
		ON/OFF								
	930 3000K CRI90	2 23°	2 Black							
	940 4000K CRI90	3 35°								
	X27 2700K CRI97									
X30 3000K CRI97										
X40 4000K CRI97										

0115 927 1 1 W

Example **011592711W** — Fost Track ø40 7W 2700K CRI90 18° White Casambi

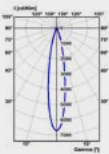

18°

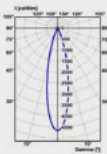

23°

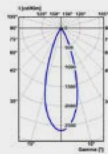

35°

Option	Color T°	CRI	Power	Lumen Output	Beam Angle
927	2700K	90	7W	632lm / 553lm / 586lm	18° / 23° / 35°
X27		97	7W	569lm / 498lm / 527lm	
930	3000K	90	7W	652lm / 570lm / 604lm	18° / 23° / 35°
X30		97	7W	587lm / 513lm / 544lm	
940	4000K	90	7W	672lm / 587lm / 622lm	18° / 23° / 35°
X40		97	7W	604lm / 528lm / 560lm	

FOST TRACK 50

incl. DIM 355° 90° 50.000hs L70 / B10 MacAdam 2&3 220-240V 50 / 60Hz 650°C

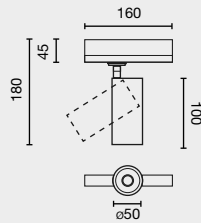

Family

Color T°

Beam Angle

Finish

Control System

0116 Fost Track ø50 15W

- 927** 2700K CRI90
- 930** 3000K CRI90
- 940** 4000K CRI90
- X27** 2700K CRI97
- X30** 3000K CRI97
- X40** 4000K CRI97

- 1** 20°
- 2** 26°
- 3** 36°

- 1** White
- 2** Black

- W** CASAMBI
- D** DALI
- ON/OFF**
- C** TRIAC

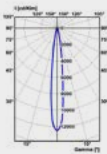

20°

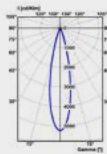

26°

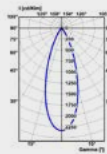

36°

Option	Color T°	CRI	Power	Lumen Output	Beam Angle
927	2700K	90	15W	1025lm / 973lm / 988lm	20° / 26° / 36°
X27	2700K	97	15W	923lm / 876lm / 889lm	20° / 26° / 36°
930	3000K	90	15W	1057lm / 1003lm / 1019lm	20° / 26° / 36°
X30	3000K	97	15W	951lm / 903lm / 917lm	20° / 26° / 36°
940	4000K	90	15W	1089lm / 1033lm / 1050lm	20° / 26° / 36°
X40	4000K	97	15W	980lm / 930lm / 945lm	20° / 26° / 36°

FOST TRACK 64

incl. DIM 355° 90° 50.000hs L70 / B10 MacAdam 2&3 220-240V 50 / 60Hz 650°C

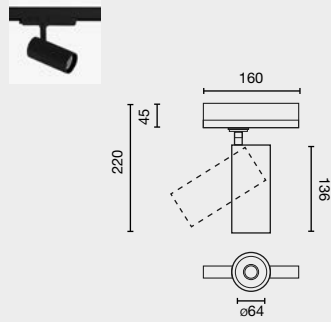

Family

Color T°

Beam Angle

Finish

Control System

0117 Fost Track ø64 28W

- 927** 2700K CRI90
- 930** 3000K CRI90
- 940** 4000K CRI90
- X27** 2700K CRI97
- X30** 3000K CRI97
- X40** 4000K CRI97

- 1** 17°
- 2** 25°
- 3** 35°
- 6** 60°

- 1** White
- 2** Black

- W** CASAMBI
- D** DALI
- ON/OFF**
- C** TRIAC

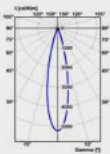

17°

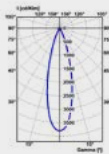

25°

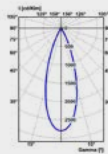

35°

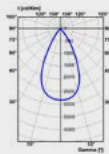

60°

Option	Color T°	CRI	Power	Lumen Output	Beam Angle
927	2700K	90	28W	2982lm / 2987lm / 2732lm / 2270lm	17° / 25° / 35° / 60°
X27		97	28W	2684lm / 2688lm / 2459lm / 2043lm	17° / 25° / 35° / 60°
930	3000K	90	28W	3075lm / 3080lm / 2817lm / 2341lm	17° / 25° / 35° / 60°
X30		97	28W	2767lm / 2771lm / 2535lm / 2107lm	17° / 25° / 35° / 60°
940	4000K	90	28W	3167lm / 3172lm / 2902lm / 2412lm	17° / 25° / 35° / 60°
X40		97	28W	2850lm / 2855lm / 2611lm / 2170lm	17° / 25° / 35° / 60°

FOST TRACK 70

incl. DIM 355° 90° 50.000hs L70 / B10 MacAdam 2&3 220-240V 50 / 60Hz 650°C

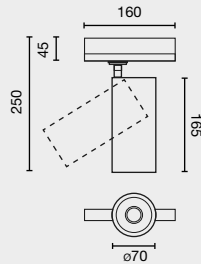

Family

Color T°

Beam Angle

Finish

Control System

0118 Fost Track ø70 43W

- 927** 2700K CRI90
- 930** 3000K CRI90
- 940** 4000K CRI90
- X27** 2700K CRI97
- X30** 3000K CRI97
- X40** 4000K CRI97
- MT** MEAT
- BR** BREAD
- FS** FASHION

- 1** 18°
- 2** 23°
- 3** 36°
- 6** 60°

- 1** White
- 2** Black

- W** CASAMBI
- D** DALI
- ON/OFF**
- C** TRIAC

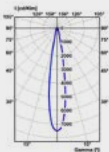

18°

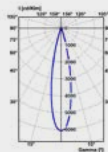

23°

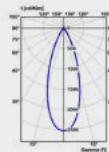

36°

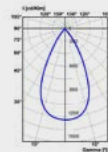

60°

Option	Color T°	CRI	Power	Lumen Output	Beam Angle
927	2700K	90	43W	3428lm / 3400lm / 3369lm / 3294lm	18° / 23° / 36° / 60°
X27		97	43W	3085lm / 3059lm / 3032lm / 2964lm	18° / 23° / 36° / 60°
930	3000K	90	43W	3534lm / 3505lm / 3473lm / 3396lm	18° / 23° / 36° / 60°
X30		97	43W	3180lm / 3154lm / 3125lm / 3056lm	18° / 23° / 36° / 60°
940	4000K	90	43W	3640lm / 3610lm / 3577lm / 3498lm	18° / 23° / 36° / 60°
X40		97	43W	3276lm / 3249lm / 3219lm / 3148lm	18° / 23° / 36° / 60°
MT	-	-	43W	2165lm / 2149lm / 2140lm / 2052lm	18° / 23° / 36° / 60°
BR	-	-	43W	2921lm / 2899lm / 2888lm / 2769lm	18° / 23° / 36° / 60°
FS	-	-	43W	2998lm / 2976lm / 2964lm / 2842lm	18° / 23° / 36° / 60°





BLIT TRACK



BLIT TRACK is a versatile solution that provides flexibility and adaptability for various lighting applications. Designed to integrate into track lighting systems, it allows for precise light direction. Its elegant design enhances any environment and offers soft, ambient lighting that creates a cozy atmosphere.

BLIT TRACK es una solución versátil que proporciona flexibilidad y adaptabilidad para diversas aplicaciones de iluminación. Diseñado para integrarse en sistemas de iluminación en carril, permite dirigir la luz de manera precisa. Su diseño elegante realza cualquier entorno y ofrece una iluminación suave y ambiental que crea una atmósfera acogedora.



BLIT Collection



Surface
295

Blit 210mm
20W

Blit 300mm
33W

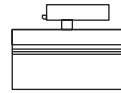

FINISH
Acabado

● **Black**
Negro

○ **White**
Blanco

COLOR TEMPERATURE
Temperatura de color

2700K CRI90

3000K CRI90

4000K CRI90

BEAM ANGLE
Ángulo de apertura

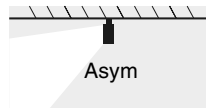

CONTROL SYSTEM
Sistema de control



CASAMBI

Highlights

Available in two power options and made entirely of aluminum and glass, BLIT TRACK provides general illumination through indirect light. Its minimalist design makes it perfect for complementing other track luminaires, such as projectors or linear lights, in environments like restaurants or commercial spaces.

Disponible en dos potencias, y fabricado íntegramente de aluminio y cristal, BLIT TRACK ofrece una iluminación general a través de luz indirecta. Su diseño minimalista lo hace perfecto para complementar otras luminarias de carril, como proyectores o luces lineales, en entornos como restaurantes o espacios comerciales.



High CRI
Alto IRC



High-quality materials
Materiales de alta calidad



Minimal design
Diseño minimalista



Restaurant

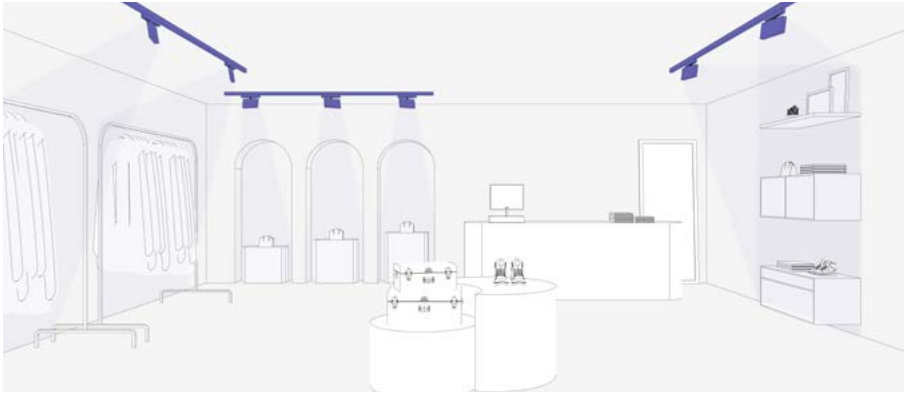

Retail

Beam Angle



Asym°

BLIT TRACK

incl. DIM 355° 30° 50.000hs L80 / B10 MacAdam 3 220-240V 50 / 60Hz 850°C

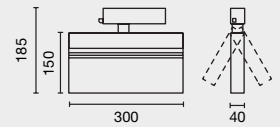
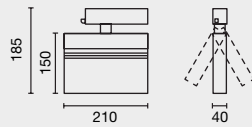

Family	Color T°	Beam Angle	Finish	Control System
0127 Blit track 210mm 20W	927 2700K CRI90	9 Asym	1 White	D DALI
0128 Blit track 300mm 33W	930 3000K CRI90		2 Black	W CASAMBI
	940 4000K CRI90			ON/OFF

0127 **927** **9** **1** **D**

Example **012792791D** — Blit track 210mm 20W 2700K CRI90 White Dali

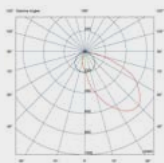

Asym

Option	Color T°	CRI	Power	Lumen Output	Beam Angle
927	2700K	90	20w	1633	Asym
		90	33w	3412	Asym
930	3000K	90	20w	1684	Asym
		90	33w	3517	Asym
940	4000K	90	20w	1734	Asym
		90	33w	3623	Asym



VIA EVO TRACK is a linear luminaire designed to seamlessly integrate into three-phase track systems. When combined with our other track luminaires, it becomes an efficient solution for providing general lighting in various spaces. It offers three different color temperatures and also comes in Tuneable White and UGR versions, allowing for lighting adjustment to meet specific needs.

VIA EVO TRACK es una luminaria lineal diseñada para adaptarse perfectamente a sistemas de carriles trifásicos. Cuando se combina con otras de nuestras luminarias de carril, se convierte en una solución eficiente para proporcionar iluminación general en espacios diversos. Ofrece tres temperaturas de color diferentes, además de contar con versiones Tuneable White y UGR, lo que permite ajustar la iluminación y satisfacer necesidades específicas.



VIA

TRACK





VIA Collection



System
433

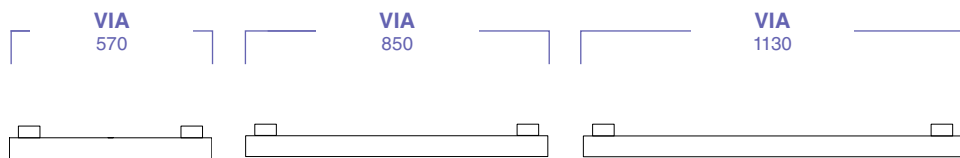

FINISH
Acabado

● **Black**
Negro

○ **White**
Blanco

COLOR TEMPERATURE
Temperatura de color

3000K CRI80

4000K CRI80

2700-6500K

DIFFUSER
Difusor



Opal



Microprisma



UGR

CONTROL SYSTEM
Sistema de Control



CASAMBI

Highlights

Offering three different sizes and a variety of power options to adapt to the lighting needs of each space, VIA EVO TRACK is also available in UGR versions, ideal for office environments, and in TW versions, designed to provide circadian cycle lighting in specific spaces.

Ofreciendo tres tamaños diferentes y una variedad de potencias para adaptarse a las necesidades lumínicas de cada espacio, VIA EVO TRACK también está disponible en versiones UGR, ideales para entornos de oficina, y en versiones TW, diseñadas para proporcionar iluminación de ciclo circadiano en espacios específicos.



Tunable White



Different sizes
Diversos tamaños



Several color temperatures
Varias temperaturas de color

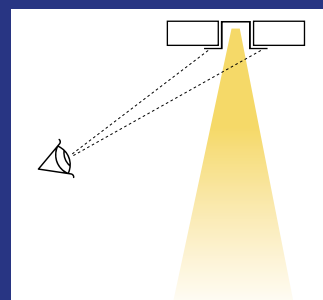

UGR<19

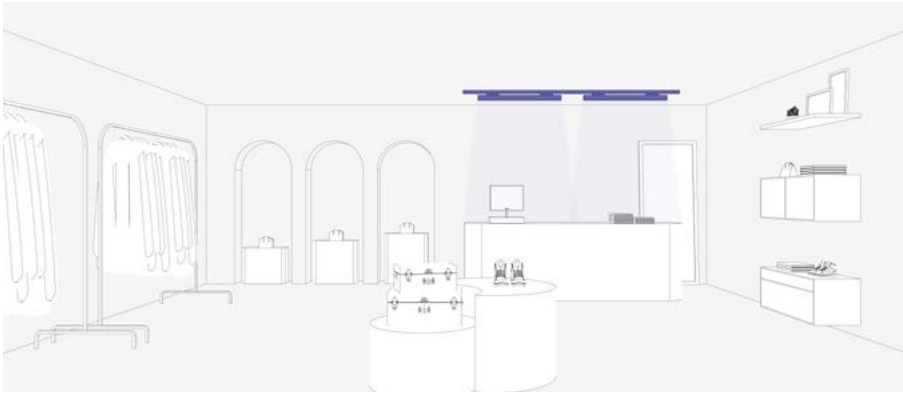

Retail



Office



Microprisma

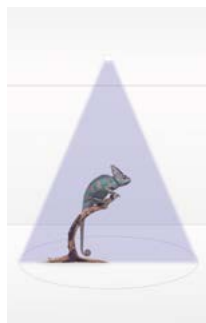

90°



Opal

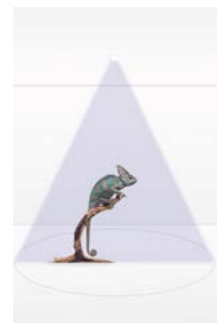

110°



UGR

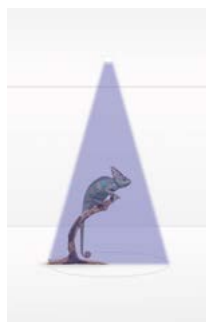

50°

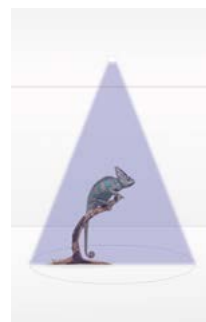

80°

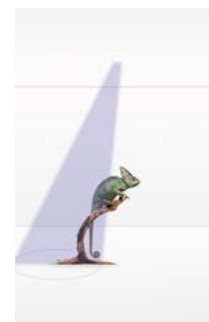

Asym°

VIA TRACK 570

incl. DIM 50.000hs L80/B10 MacAdam 3 TW 220-240V 50/60Hz 650°C

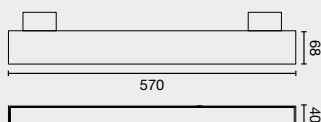

Family	Power	Finish	Control System	Diffuser
0410T Via Evo	590	Track 15W 3000K CRI80	ON/OFF W CASAMBI D DALI	Opal
	570	Track 25W 3000K CRI80		U Microprisma
	680	Track 15W 4000K CRI80		
	660	Track 25W 4000K CRI80		
0410T Via Evo	010	Track 27W 2700-6500K TW	W CASAMBI DALI	Opal
				U Microprisma

0410T 570 1 W

Example 0410T5701W — Via Evo Track 570 mm 25W 3000K Opal White

VIA TRACK 850

incl. DIM 50.000hs L80/B10 MacAdam 3 TW 220-240V 50/60Hz 650°C

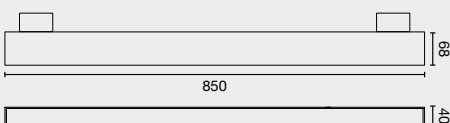

Family	Power	Finish	Control System	Diffuser
0410T Via Evo	560	Track 20W 3000K CRI80	ON/OFF W CASAMBI D DALI	Opal
	540	Track 38W 3000K CRI80		U Microprisma
	650	Track 20W 4000K CRI80		
	630	Surface 38W 4000K CRI80		
0410T Via Evo	030	Track 39W 2700-6500K TW	W CASAMBI DALI	Opal
				U Microprisma

VIA TRACK 1130

incl. DIM 50.000hs L80/B10 MacAdam 3 TW 220-240V 50 / 60Hz 650°C UGR 16

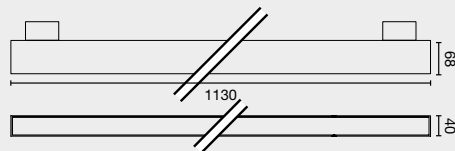

Family	Power	Finish	Control System	Diffuser
0410T Via Evo	530 Track 27W 3000K CRI80	1 White	ON/OFF	Opal
	510 Track 51W 3000K CRI80	2 Black	W CASAMBI	U Microprisma
	620 Track 27W 4000K CRI80		D DALI	
	600 Track 51W 4000K CRI80			
0410T Via Evo	050 Track 48W 2700-6500K TW	1 White	W CASAMBI	Opal
		2 Black	D DALI	U Microprisma
0410T Via Evo	110 Track UGR 32W 3000K CRI80	1 White	ON/OFF	8 UGR<19 80°
	120 Track UGR 32W 4000K CRI80	2 Black	W CASAMBI	5 UGR<16 50°
	111 Track UGR 17W 3000K CRI80		D DALI	0 UGR<19 asim.
	121 Track UGR 17W 4000K CRI80			
0410T Via Evo	010 Track UGR 54W 2700-6500K TW	1 White	W CASAMBI	8 UGR<19 80°
		2 Black	D DALI	5 UGR<16 50°
				0 UGR<19 asim.

VIA TRACK

570mm

Option	Color T°	CRI	Difusor	Power	Lumen Output	Beam Angle
590	3000K	80	Opal / Microprisma	15W	1392lm / 1133lm	110° / 90°
570		80	Opal / Microprisma	25W	2506m / 2039m	110° / 90°
680	4000K	80	Opal / Microprisma	15W	1434lm / 1167lm	110° / 90°
660		80	Opal / Microprisma	25W	2581lm / 2100lm	110° / 90°
010	2700-6500K	TW	Opal / Microprisma	27W	1964lm / 1598lm	110° / 90°

850mm

560	3000K	80	Opal / Microprisma	20W	2131lm / 1735lm	110° / 90°
540		80	Opal / Microprisma	38W	3809lm / 3121lm	110° / 90°
650	4000K	80	Opal / Microprisma	20W	2195lm / 1787lm	110° / 90°
630		80	Opal / Microprisma	39W	3923lm / 3214lm	110° / 90°
010	2700-6500K	TW	Opal / Microprisma	39W	2985lm / 2429lm	110° / 90°

1130mm

530	3000K	80	Opal / Microprisma	27W	2842lm / 2313lm	110° / 90°
510		80	Opal / Microprisma	51W	5112lm / 4161lm	110° / 90°
620	4000K	80	Opal / Microprisma	27W	2927lm / 2382lm	110° / 90°
600		80	Opal / Microprisma	51W	5265lm / 4286lm	110° / 90°
050	2700-6500K	TW	Opal / Microprisma	48W	4006lm / 3261lm	110° / 90°
110	3000K	80	UGR<16 / UGR<19	32W	3989lm / 4104lm / 3739lm	50° / 80° / Asym
120	4000K	80	UGR<16 / UGR<19	32W	4109lm / 4227lm / 3851lm	50° / 80° / Asym
010	2700-6500K	TW	UGR<16 / UGR<19	54W	4830lm / 4881lm / 4467lm	50° / 80° / Asym



How to install

CÓMO INSTALARLO

3Phase track, 16 A

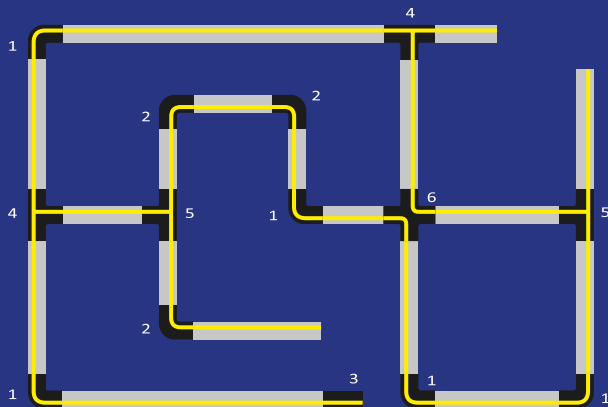

1 Outer "L" joint



2 Inner "L" joint



3 Outer live end



4 Outer "T"



5 Inner "T"



6 Cross joint

Connection sketch Esquema de conexiones

1 Circuit

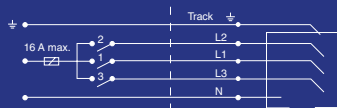

N-conductor $i = 16$ A max

2 Circuit

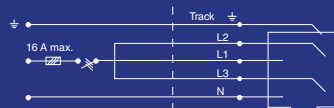

N-conductor $i = 16$ A max

3 Circuit

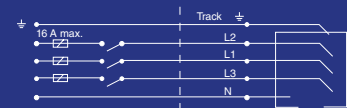

$L1 + L2 + L3$ $i = 16$ A max

Recommended distance between fixing Distancia recomendada entre fijaciones

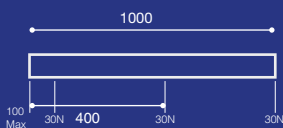

Max.Weight: 19,84 lb
Peso máx.: 9 kg

Max. 3 projectors = 3,8 KVA
Máx. 3 proyectores = 3,8 KVA



Max.Weight: 33,06 lb
Peso máx.: 15 kg

Max. 5 projectors = 3,8 KVA
Máx. 5 proyectores = 3,8 KVA

3Phase Track

Compatible with IVELA & GLOBAL



Surface & Suspended 3 phase track

01990101	● White	1000 mm
01990102	● Black	1000 mm
01990201	● White	2000 mm
01990202	● Black	2000 mm

Inner live end

	01990601	● White
	01990602	● Black

Outer live end

	01990701	● White
	01990702	● Black

Centre feed

	01993301	● White
	01993302	● Black

Inner "L" Joint

	01990501	● White
	01990502	● Black

Outer "L" Joint

	01990401	● White
	01990402	● Black

Outer "T"

	01990901	● White
	01990902	● Black

Inner "T"

	01991601	● White
	01991602	● Black

Ceiling kit 1 piece

	01991201	● Aluminium
---	----------	-------------

Cross Joint

	01991001	● White
	01991002	● Black

Intermediate Joint

	01990801	● White
	01990802	● Black

End cap

	01991101	● White
	01991102	● Black

Flexible "L"

	01993201	● White
	01993202	● Black

Pendant Kit 2000

	01990301	● White
	01990302	● Black

Adapter / track connector

	01997001	● White
	01997002	● Black



Surface & Suspended Dali track

01990101D	● White	1000 mm
01990102D	● Black	1000 mm
01990201D	● White	2000 mm
01990202D	● Black	2000 mm

Dali inner live end

	01993501D	● White
	01993502D	● Black

Dali outer live end

	01993601D	● White
	01993602D	● Black

Dali centre feed

	01993301D	● White
	01993302D	● Black

Inner "L" Joint

	01990501D	● White
	01990502D	● Black

Outer "L" Joint

	01990401D	● White
	01990402D	● Black

Ceiling kit 1piece

	01991201D	● White
	01991202D	● Black

Intermediate Joint

	01990801D	● White
	01990802D	● Black

End cap

	01991101D	● White
	01991102D	● Black

Flexible "L"

	01993201D	● White
	01993202D	● Black

Pendant Kit 5000

	01990301D	● White
	01990302D	● Black

Adapter / track connector

	01997001D	● White
	01997002D	● Black



Recessed 3 phase track

01997101	● White	1000 mm
01997102	● Black	1000 mm
01997201	● White	2000 mm
01997202	● Black	2000 mm

Inner live end

	01997401	● White
	01997402	● Black

Outer live end

	01997301	● White
	01997302	● Black

Centre feed

	01997801	● White
	01997802	● Black

Intermediate Joint

	01997501	● White
	01997502	● Black

End cap

	01997701	● White
	01997702	● Black

Ceiling Kit 1piece

	01997601	● Aluminium
---	----------	-------------

Adapter / track connector

	01997001	● White
	01997002	● Black



D O W N L

L I G H T S

NEW

ELIOS

The ELIOS downlight family is designed to offer versatility and efficiency in any space. With three available power options and an IP54 rating, this family adapts to a variety of needs. Its range of reflectors, from simple fixed models to versions with decorative details, allows for customization according to the environment. Equipped with the latest LED technology, ELIOS ensures superior energy performance. Additionally, the range includes adjustable versions, wallwashers, and both single and double frames, providing complete solutions for any architectural project.

La familia de downlights ELIOS ha sido diseñada para ofrecer versatilidad y eficiencia en cualquier espacio. Con tres potencias disponibles y la opción de IP54, esta familia se adapta a diversas necesidades. Su variedad de reflectores, que van desde el simple fijo hasta versiones con detalles decorativos, permiten personalizar el diseño según el ambiente. Equipados con la última tecnología LED, los ELIOS garantizan un rendimiento energético superior. Además, la gama incluye versiones orientables, wallwasher, y marcos tanto individuales como dobles, ofreciendo soluciones completas para cualquier proyecto arquitectónico.







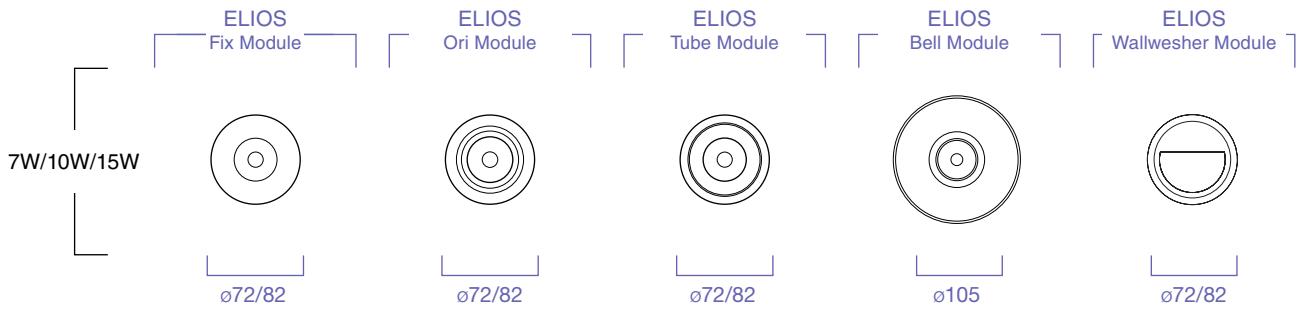

FINISH
Acabado

- Black**
Negro
- White**
Blanco

COLOR TEMPERATURE
Temperatura de color

- 2700K CRI90**
- 3000K CRI90**
- 4000K CRI90**
- 2400-6500K THRIVE**

BEAM ANGLE
Ángulo de apertura

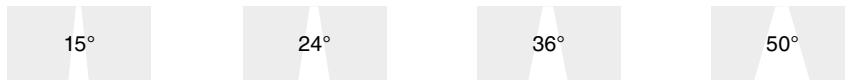

ACCESSORIES
Accesorios

-  Honeycomb
-  Striped glass
-  Woven glass

CONTROL SYSTEM
Sistema de control



Highlights

ELIOS incorporates LED technology that offers a balance between visual comfort and high efficiency, maintaining a CRI of 90 thanks to the use of next-generation LEDs. Additionally, it includes the TW option with Thrive technology, which promotes a focus on healthy lighting. All variants are available with IP20 and IP54 protection ratings.

ELIOS incorpora una tecnología LED que ofrece un equilibrio entre confort visual y alta eficiencia, manteniendo un CRI 90 gracias al uso de LEDs de última generación. Además, cuenta con la opción TW con tecnología Thrive, que promueve un enfoque hacia una iluminación saludable. Todas las variantes están disponibles con grados de protección IP20 e IP54.

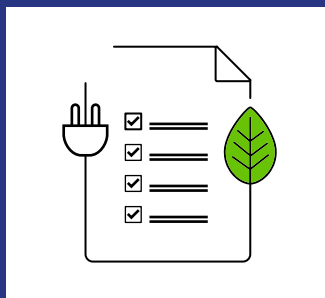

High Efficiency CRI90
Alta eficiencia

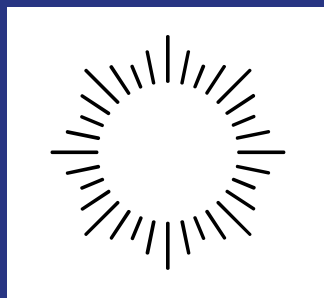

Thrive Technology
Tecnología Thrive



Tunable White



Optional IP54
Opción IP54

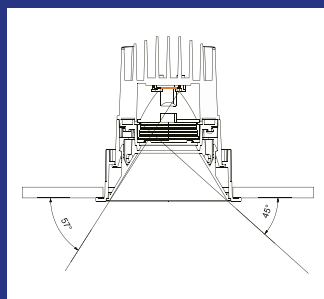

Visual Confort
Confort visual





Trim White



Trim Black



Trimless



Double White



Double Black



Double Trimless White



Double Trimless Black



Honeycomb



Woven Glass



Striped Glass

Accessories

Honeycomb 0700PP0001	Woven Glass 0700PP0002	Striped Glass 0700PP0003	Trimless 0700PP0301	Trim White 0700PP0303
Trim Black 0700PP0304	Double White 0700PP0305	Double Black 0700PP0306	Double Trimless White 0700PP0307	Double Trimless Black 0700PP0308



Residential



Hotel



Restaurant

Beam Angle



15°



24°

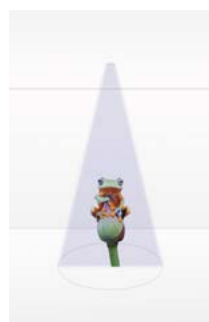

36°

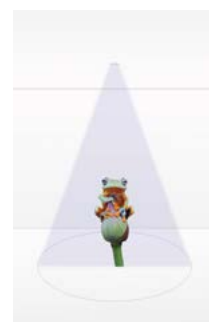

50°

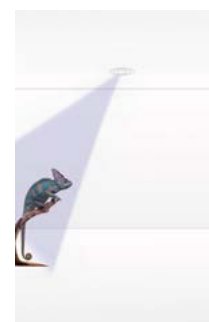

Asym°

ELIOS FIX MODULE

NEW

incl. DIM 50.000hs L70 / B10 MacAdam 3 220-240V 650°C



1. CONFIGURE YOUR MODULE

Family	IP	Power	Color T°	Beam Angle	Finish	Control System		
0700 Elios Fix Module	2	IP20	7 7W	927 2700K CRI90	1 15°	1 White	W CASAMBI	
			1 10W	930 3000K CRI90	2 24°	2 Black	D DALI	
			5 15W	940 4000K CRI90	3 36°		C TRIAC	
		5	IP54	1 10W	930 3000K CRI90	4 48°	2 Black	ON/OFF
				5 15W	940 4000K CRI90	5 50°		

TW 2400-6500K THRIVE

W CASAMBI
D DALI

0700 2 7 927 1 1 W

Example 07002792711W — Elios Fix Module IP20 7W 2700K CRI90 15° White Casambi

2. CHOOSE YOUR TRIM



Trim White
0700PP0303



Trim Black
0700PP0304



Trimless
0700PP0301



Double White
0700PP0305



Double Black
0700PP0306



Double Trimless White
0700PP0307



Double Trimless Black
0700PP0308

3. FINAL CONFIGURATIONS OF MODULES AND TRIMS

Examples of combinations module + trim



07002792722W
+ 0700PP0303



07002792722W
+ 0700PP0301



2x 07002792722W
+ 0700PP0305



2x 07002792722W
+ 0700PP0308



07002792712W
+ 0700PP0303



07002792712W
+ 0700PP0301



2x 07002792712W
+ 0700PP0305



2x 07002792722W
+ 0700PP0307

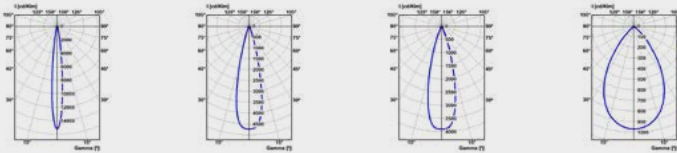
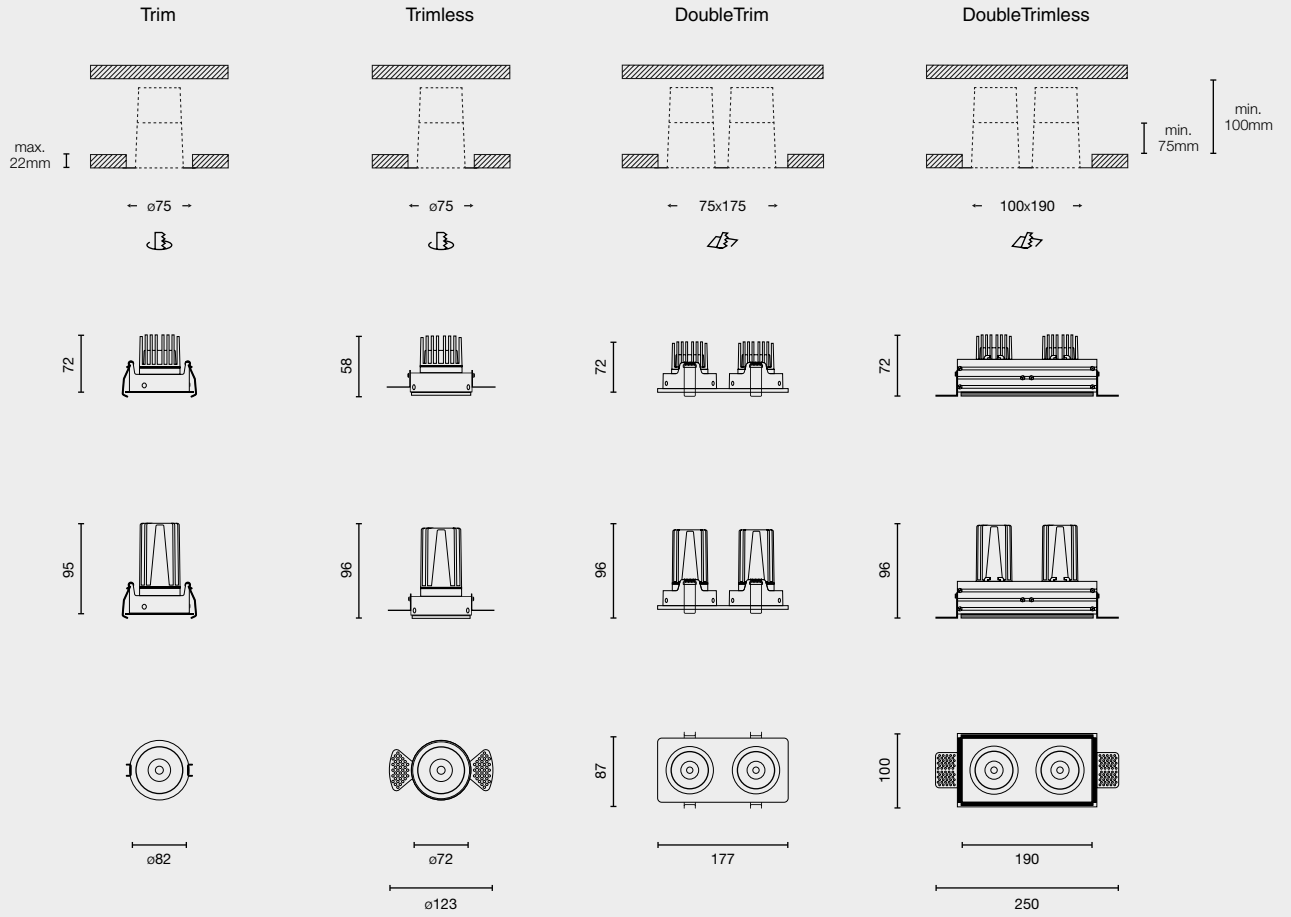

15°

24°

36°

50°

Option	Color T°	CRI	Power	Lumen Output	Beam Angle
927	2700K	90	7W	538lm / 553lm / 597lm / 576lm	15° / 24° / 36° / 50°
			10W	804lm / 827lm / 892lm / 861lm	15° / 24° / 36° / 50°
			15W	1075lm / 1106lm / 1193lm / 1152lm	15° / 24° / 36° / 50°
930	3000K	90	7W	554lm / 557lm / 615lm / 594lm	15° / 24° / 36° / 50°
			10W	828lm / 853lm / 920lm / 888lm	15° / 24° / 36° / 50°
			15W	1107lm / 1140lm / 1130lm / 1187lm	15° / 24° / 36° / 50°
940	4000K	90	7W	571lm / 588lm / 634lm / 612lm	15° / 24° / 36° / 50°
			10W	854lm / 879lm / 948lm / 915lm	15° / 24° / 36° / 50°
			15W	1141lm / 1175lm / 1267lm / 1223lm	15° / 24° / 36° / 50°
TW	2700K-6500K	THRIVE	10W	611lm / 630lm / 679lm / 655lm	15° / 24° / 36° / 50°

ELIOS ORIENTABLE MODULE



- incl.
- DIM
- 355°
- 25°
- 50.000hs L70 / B10
- MacAdam 3
- 220-240V
- 650°C



1.CONFIGURE YOUR MODULE

Family	IP	Power	Color T°	Beam Angle	Finish	Control System			
0701 Elios Orientable Module	2	IP20	7 7W	927 2700K CRI90	1 15°	1 White	W CASAMBI		
			1 10W	930 3000K CRI90	2 24°	2 Black	D DALI		
		5	IP54	5 15W	940 4000K CRI90		3 36°	C TRIAC	
						5 50°	ON/OFF		
								TW 2400-6500K THRIVE	W CASAMBI
									D DALI

0701 2 7 927 1 1 W

Example 07012792711W — Elios Orientable Module IP20 7W 2700K CRI90 15° White Casambi

2.CHOOSE YOUR TRIM

Trim White 0700PP0303	Trim Black 0700PP0304	Trimless 0700PP0301	Double White 0700PP0305	Double Black 0700PP0306	Double Trimless White 0700PP0307	Double Trimless Black 0700PP0308

3.FINAL CONFIGURATIONS OF MODULES AND TRIMS

Examples of combinations module + trim

Examples 07015793012D + 0700PP0303	07015593012D + 0700PP0301	2x 07015593012D + 0700PP0306	2x 07015593011 + 0700PP0307
Examples 07015793011D + 0700PP0303	07015593011D + 0700PP0301	2x 07015593012D + 0700PP0305	2x 07015593011 + 0700PP0308

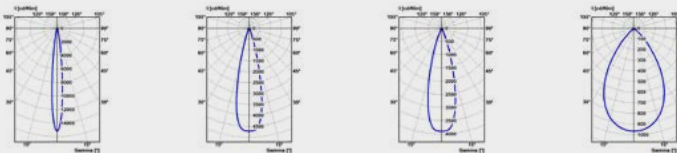
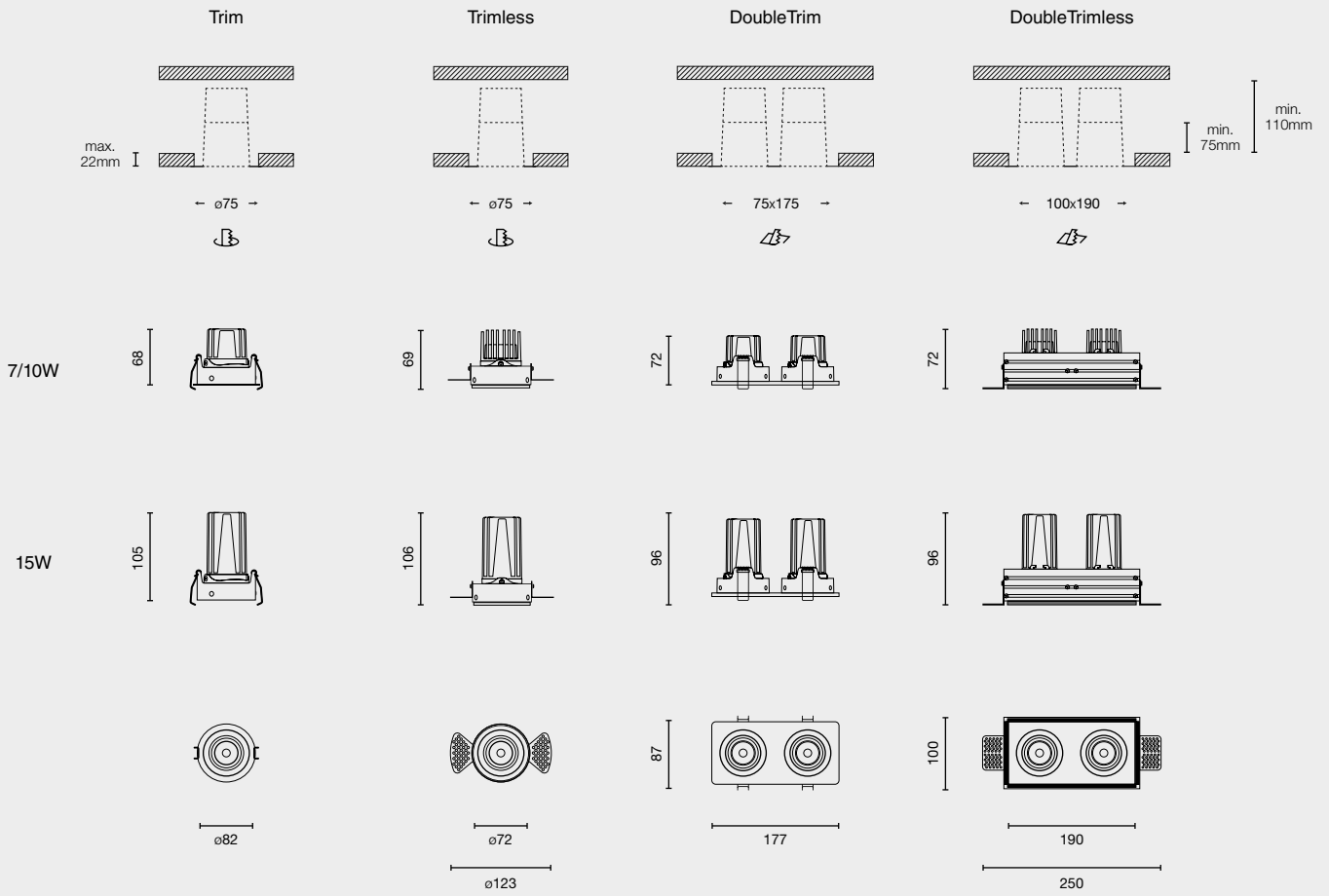

15°

24°

36°

50°

Option	Color T°	CRI	Power	Lumen Output	Beam Angle
927	2700K	90	7W	519lm / 539lm / 617lm / 549lm	15° / 24° / 36° / 50°
			10W	705lm / 863lm / 891lm / 936lm	15° / 24° / 36° / 50°
			15W	917lm / 1124lm / 1160lm / 1088lm	15° / 24° / 36° / 50°
930	3000K	90	7W	475lm / 582lm / 600lm / 564lm	15° / 24° / 36° / 50°
			10W	726lm / 890lm / 918lm / 862lm	15° / 24° / 36° / 50°
			15W	946lm / 1159lm / 1195lm / 1122lm	15° / 24° / 36° / 50°
940	4000K	90	7W	489lm / 599lm / 618lm / 580lm	15° / 24° / 36° / 50°
			10W	748lm / 917lm / 946lm / 888lm	15° / 24° / 36° / 50°
			15W	974lm / 1193lm / 1231lm / 1156lm	15° / 24° / 36° / 50°
TW	2700K-6500K	THRIVE	10W	522lm / 639lm / 660lm / 619lm	15° / 24° / 36° / 50°



COFFEE

FLAT WHITE

35

DIRTY

35

CAPPUCCINO

35

HONEYCOM

35

AMERICANO

28

MATCHA LATTE

32

ESPRESSO

20

BLACK TEA LATTE

33

LATTE

35

OSMANTHUS LATTE

32

MACCHIATOE

35

BLACK SUGAR LATTE

32

SALT COFFEE

35

SALT CHEESE COFFEE

30



ELIOS TUBE MODULE

NEW

incl. DIM 355° 25° 50.000hs L70 / B10 MacAdam 3 220-240V 650°C



1. CONFIGURE YOUR MODULE

Family	IP	Power	Color T°	Beam Angle	Finish	Control System	
0702 Elios Tube Module	2	IP20	7 7W	927 2700K CRI90	1 15°	1 White	W CASAMBI
			1 10W	930 3000K CRI90	2 24°	2 Black	D DALI
			5 15W	940 4000K CRI90	3 36°		C TRIAC
	5	IP54	1 10W	930 3000K CRI90	4 48°	2 Black	ON/OFF
			5 15W	940 4000K CRI90	5 50°		
				TW 2400-6500K THRIVE			W CASAMBI
							D DALI

0702 2 7 927 1 1 W

Example 07022792711W — Elios Tube Module IP20 7W 2700K CRI90 15° White Casambi

2. CHOOSE YOUR TRIM

Trim White 0700PP0303	Trim Black 0700PP0304	Trimless 0700PP0301	Double White 0700PP0305	Double Black 0700PP0306	Double Trimless White 0700PP0307	Double Trimless Black 0700PP0308

3. FINAL CONFIGURATIONS OF MODULES AND TRIMS

Examples of combinations module + trim

Examples 070221TW22D + 0700PP0303	070221TW22D + 0700PP0301	2x 070221TW22D + 0700PP0305	2x 070221TW22D + 0700PP0307
Examples 070221TW11D + 0700PP0303	070221TW11D + 0700PP0305	2x 070221TW11D + 0700PP0306	2x 070221TW11D + 0700PP0308

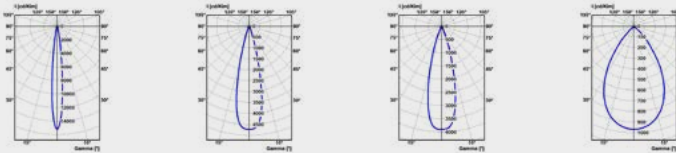
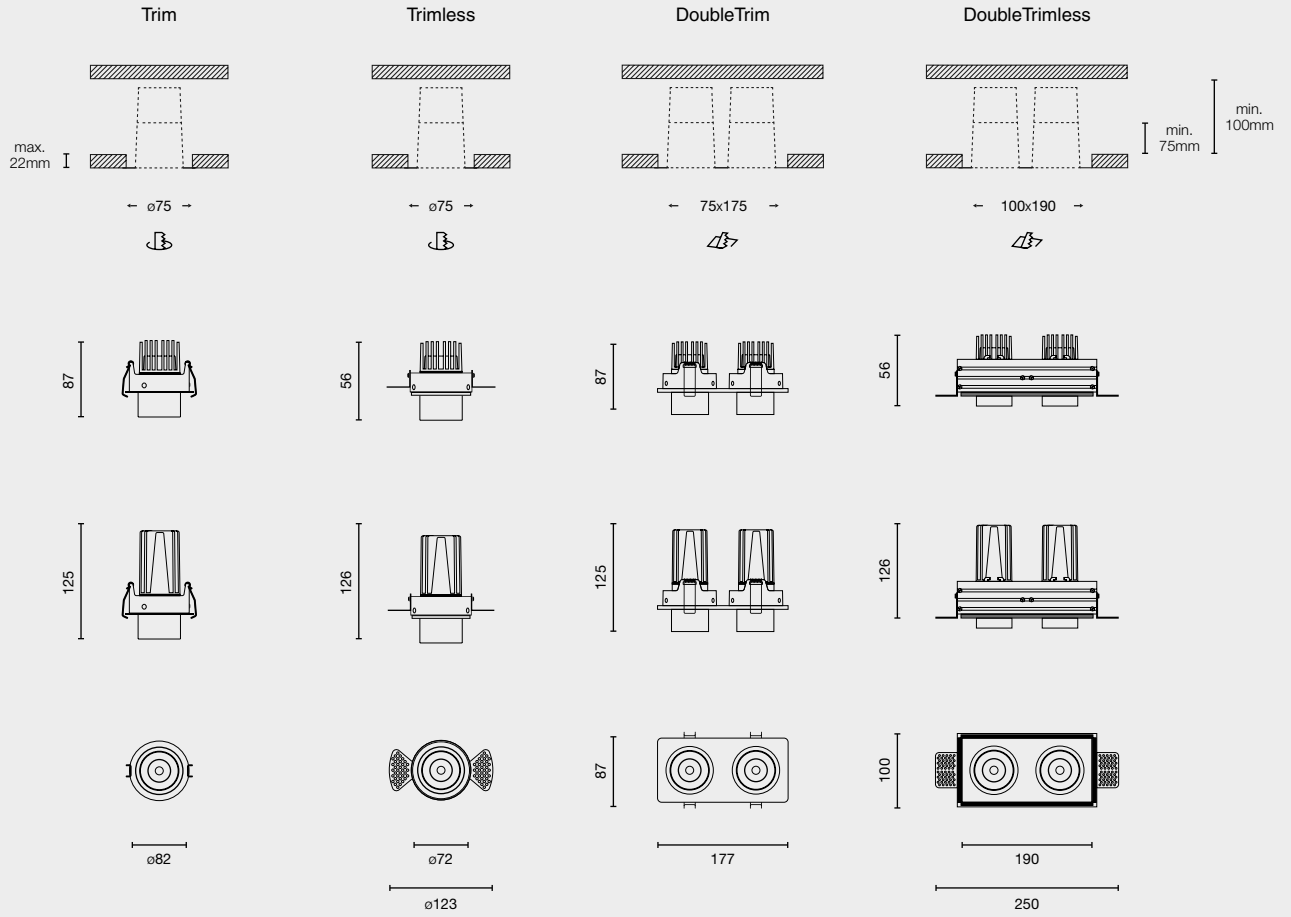

15°

24°

36°

50°

Option	Color T°	CRI	Power	Lumen Output	Beam Angle
927	2700K	90	7W	461lm / 565lm / 611lm / 519lm	15° / 24° / 36° / 50°
			10W	599lm / 734lm / 794lm / 675lm	15° / 24° / 36° / 50°
			15W	801lm / 983lm / 1062lm / 902lm	15° / 24° / 36° / 50°
930	3000K	90	7W	475lm / 582lm / 630lm / 535lm	15° / 24° / 36° / 50°
			10W	618lm / 757lm / 819lm / 696lm	15° / 24° / 36° / 50°
			15W	826lm / 1013lm / 1095lm / 930lm	15° / 24° / 36° / 50°
940	4000K	90	7W	489lm / 600lm / 649lm / 522lm	15° / 24° / 36° / 50°
			10W	637lm / 780lm / 844lm / 717lm	15° / 24° / 36° / 50°
			15W	851lm / 1045lm / 1130lm / 958lm	15° / 24° / 36° / 50°
TW	2700K-6500K	THRIVE	10W	456lm / 560lm / 605lm / 513lm	15° / 24° / 36° / 50°

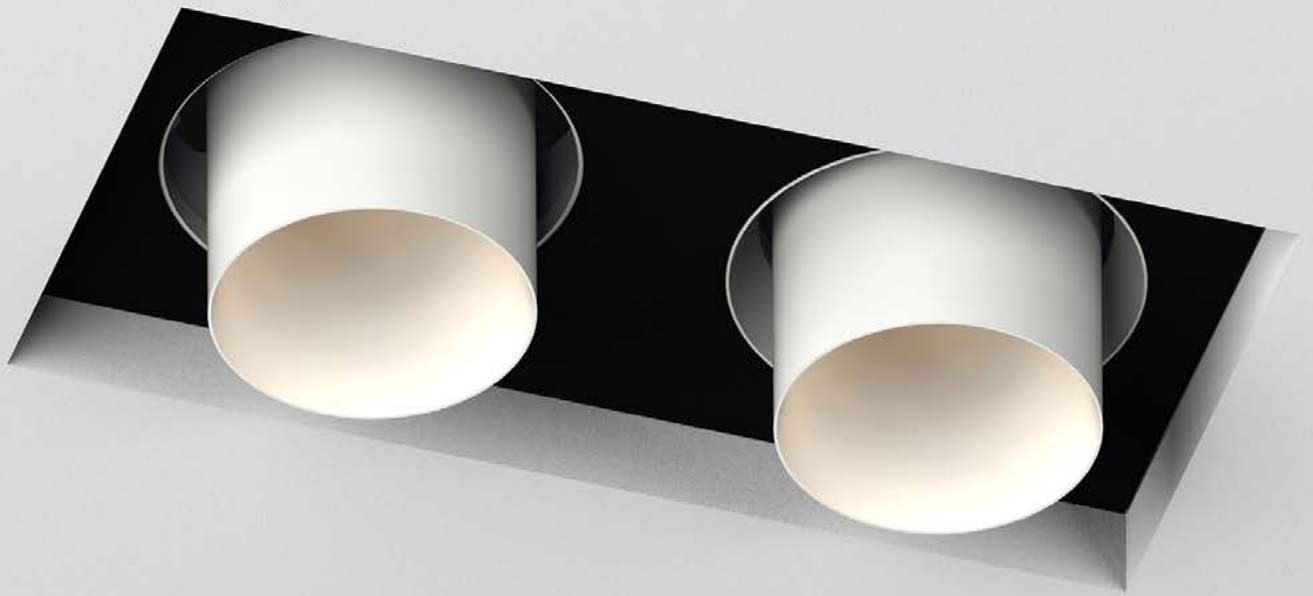



ELIOS BELL MODULE



incl. DIM 50.000hs L70 / B10 MacAdam 3 220-240V 650°C



1. CONFIGURE YOUR MODULE

Family	IP	Power	Color T°	Beam Angle	Finish	Control System	
0703 Elios Bell Module	2 IP20	7 7W	927 2700K CRI90	1 15°	1 White	W CASAMBI	
		1 10W	930 3000K CRI90	2 24°	2 Black	D DALI	
		5 15W	940 4000K CRI90	3 36°		C TRIAC	
	5 IP54				5 50°		ON/OFF

TW 2400-6500K THRIVE

W CASAMBI
D DALI

2. CHOOSE YOUR TRIM



Trim White
0700PP0303



Trim Black
0700PP0304



Trimless
0700PP0301

3. FINAL CONFIGURATIONS OF MODULES AND TRIMS

Examples of combinations module + trim



Examples

07035794032C
+ 0700PP0303



07035794031C
+ 0700PP0303



07035794032C
+ 0700PP0301



07035794031C
+ 0700PP0301

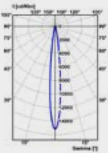
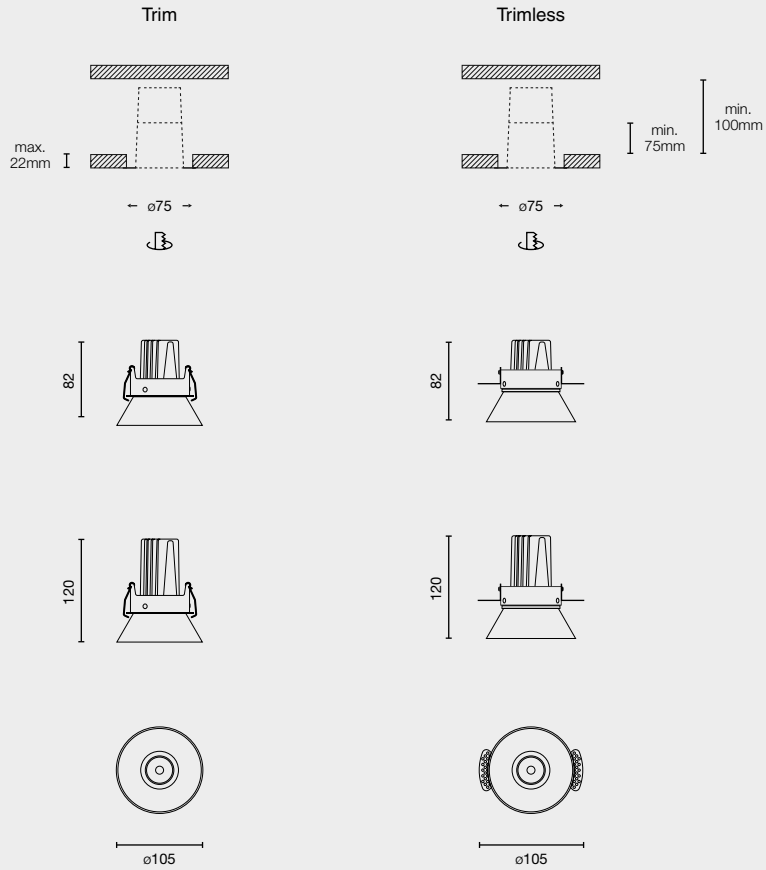

15°

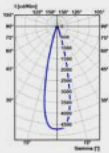

24°

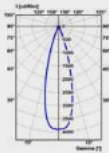

36°

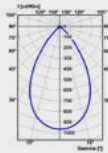

50°

Option	Color T°	CRI	Power	Lumen Output	Beam Angle
927	2700K	90	7W	532lm / 551lm / 592lm / 578lm	15° / 24° / 36° / 50°
			10W	789lm / 817lm / 878lm / 858lm	15° / 24° / 36° / 50°
			15W	1065lm / 1104lm / 1185lm / 1158lm	15° / 24° / 36° / 50°
930	3000K	90	7W	548lm / 568lm / 610lm / 596lm	15° / 24° / 36° / 50°
			10W	813lm / 843lm / 905lm / 885lm	15° / 24° / 36° / 50°
			15W	1097lm / 1137lm / 1222lm / 1194lm	15° / 24° / 36° / 50°
940	4000K	90	7W	564lm / 585lm / 628lm / 614lm	15° / 24° / 36° / 50°
			10W	837lm / 866lm / 932lm / 911lm	15° / 24° / 36° / 50°
			15W	1131lm / 1172lm / 1258lm / 1230lm	15° / 24° / 36° / 50°
TW	2700K-6500K	THRIVE	10W	606lm / 628lm / 675lm / 659lm	15° / 24° / 36° / 50°





ELIOS WALL WASHER MODULE



incl. DIM 50.000hs L70 / B10 MacAdam 3 220-240V 650°C



1.CONFIGURE YOUR MODULE

Family	IP	Power	Color T°	Beam Angle	Finish	Control System	
0704 Elios Wall Washer Module	2	IP20	7 7W	1 15° 2 24° 3 36° 5 50°	1 White	W CASAMBI	
	5	IP54	1 10W		927 2700K CRI90	2 Black	D DALI
			5 15W		930 3000K CRI90		C TRIAC
			940 4000K CRI90			ON/OFF	

TW 2400-6500K THRIVE

W CASAMBI
D DALI

2.CHOOSE YOUR TRIM



Trim White
0700PP0303



Trim Black
0700PP0304



Trimless
0700PP0301

3.FINAL CONFIGURATIONS OF MODULES AND TRIMS

Examples of combinations module + trim



Examples

07042793022W
+ 0700PP0303



07042793011W
+ 0700PP0303



07042793022W
+ 0700PP0301



07042793011W
+ 0700PP0301

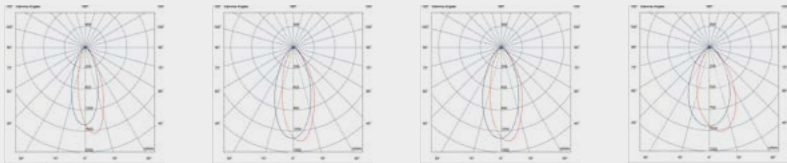
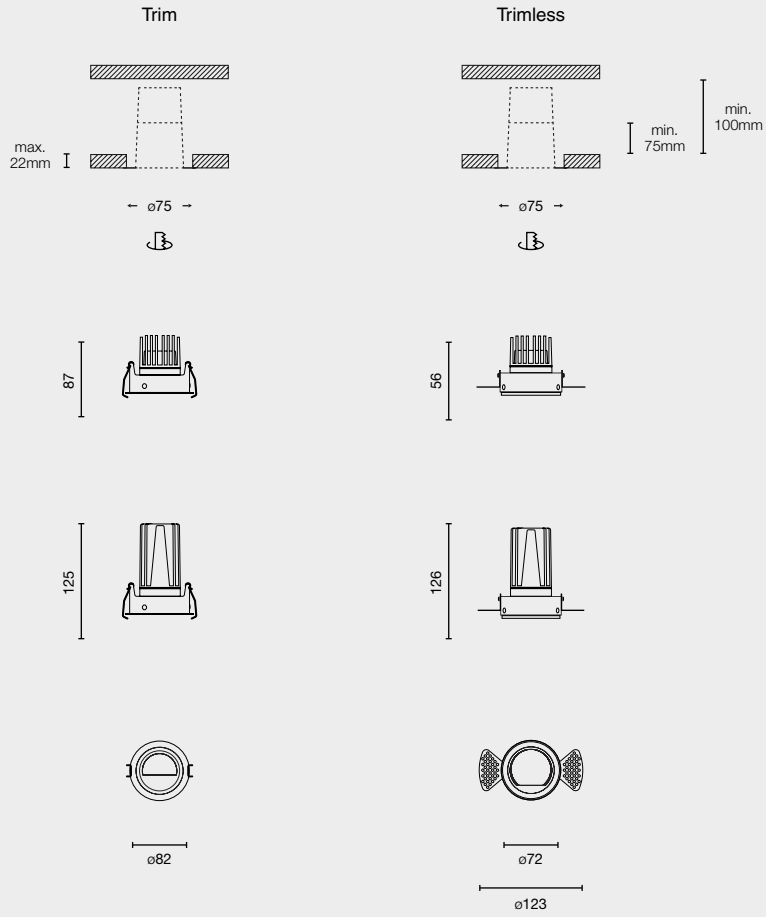

15°

24°

36°

50°

Option	Color T°	CRI	Power	Lumen Output	Beam Angle
927	2700K	90	7W	293lm / 306lm / 315lm / 296lm	15° / 24° / 36° / 50°
			10W	448lm / 467lm / 482lm / 452lm	15° / 24° / 36° / 50°
			15W	583lm / 608lm / 628lm / 589lm	15° / 24° / 36° / 50°
930	3000K	90	7W	302lm / 315lm / 325lm / 305lm	15° / 24° / 36° / 50°
			10W	461lm / 481lm / 497lm / 466lm	15° / 24° / 36° / 50°
			15W	601lm / 627lm / 647lm / 607lm	15° / 24° / 36° / 50°
940	4000K	90	7W	311lm / 324lm / 335lm / 314lm	15° / 24° / 36° / 50°
			10W	476lm / 496lm / 512lm / 480lm	15° / 24° / 36° / 50°
			15W	619lm / 646lm / 666lm / 625lm	15° / 24° / 36° / 50°
TW	2700K-6500K	THRIVE	10W	332lm / 346lm / 357lm / 335lm	15° / 24° / 36° / 50°

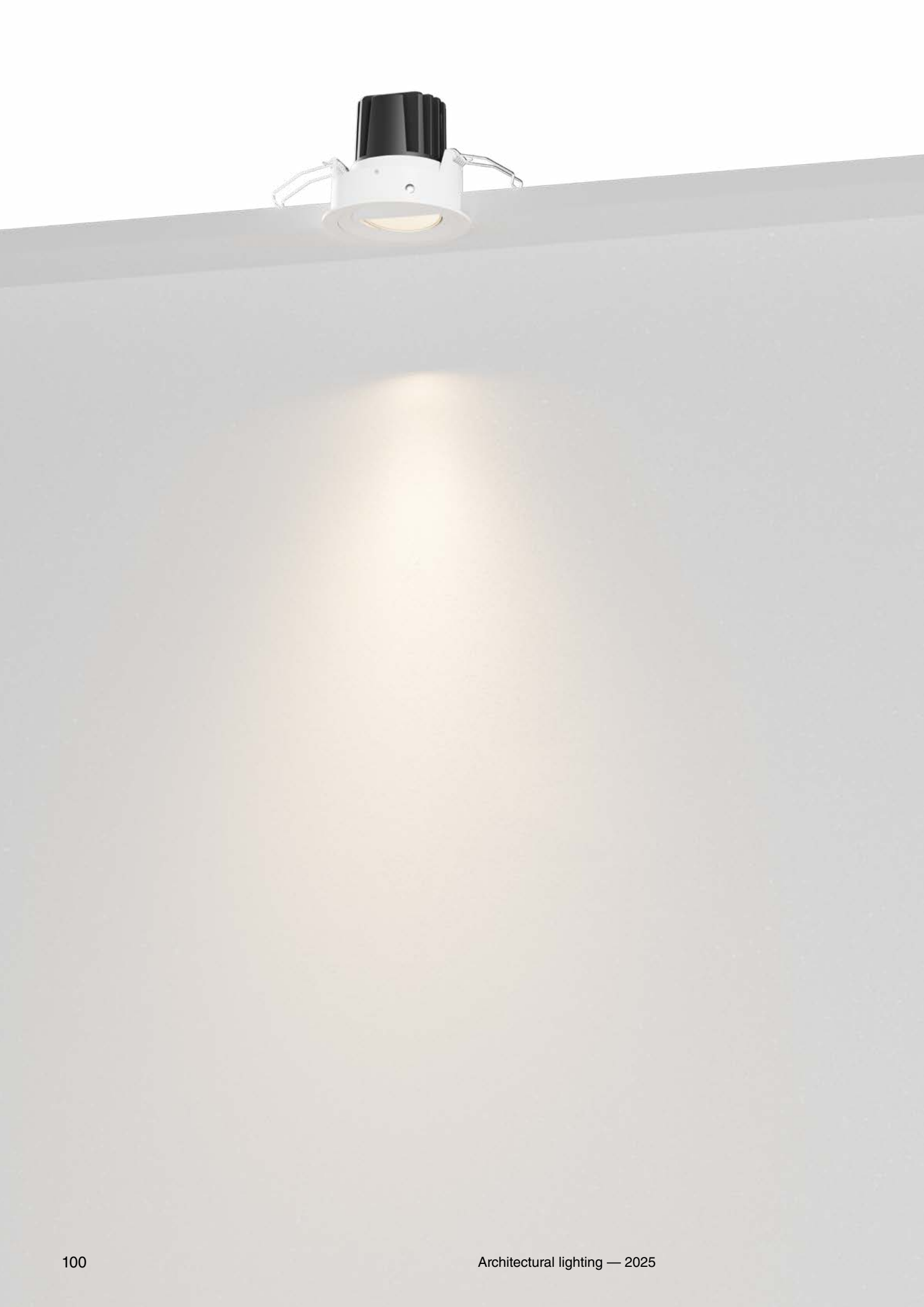

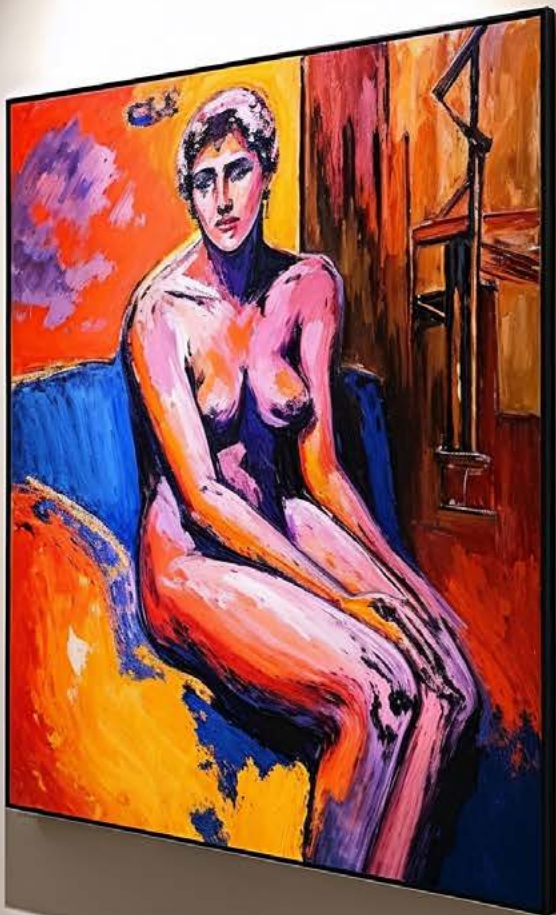



ALIA



The ALIA downlight stands out for its compact design, making it ideal for installations that require a low recess depth. Its innovative hinge allows for a 90-degree pivot, making it the perfect choice for illuminating artwork or other focal points in a space. ALIA is a product with a very specific function, designed to provide precise and efficient solutions in projects that demand focused and versatile lighting.

El downlight ALIA se distingue por su diseño compacto, ideal para instalaciones que requieren una baja cota de empotramiento. Su innovadora bisagra permite un giro de 90 grados, lo que lo convierte en la opción perfecta para iluminar cuadros u otros elementos destacados en el espacio. ALIA es un producto con una función muy específica, diseñado para ofrecer soluciones precisas y eficientes en proyectos que demandan una iluminación dirigida y versátil.



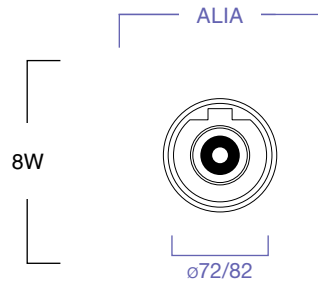

FINISH
Acabado

● **Black**
Negro

○ **White**
Blanco

COLOR TEMPERATURE
Temperatura de color

2700K CRI90

3000K CRI90

BEAM ANGLE
Ángulo de apertura

15°

24°

36°

50°

CONTROL SYSTEM
Sistema de control



CASAMBI



Highlights



LOW height ceiling Altura de techo baja

This luminaire is designed for low ceiling applications, offering flexibility with various color temperature options to adapt to different settings. It ensures high efficiency, promoting energy savings and sustainability. Additionally, it features connectivity capabilities, allowing integration with modern control systems for enhanced functionality.

Esta luminaria está diseñada para aplicaciones con techos bajos, ofreciendo flexibilidad con varias opciones de temperatura de color para adaptarse a diferentes entornos. Garantiza una alta eficiencia, promoviendo el ahorro de energía y la sostenibilidad. Además, cuenta con capacidades de conectividad, permitiendo la integración con sistemas de control modernos para una funcionalidad mejorada.



Several color temperatures
Varias temperaturas de color



High Efficiency
Alta eficacia



Connectivity
Conectividad



Residential



Restaurant

Beam Angle



15°



24°

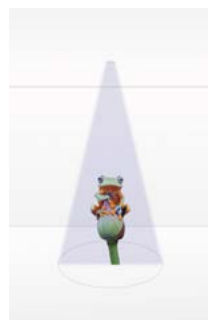

36°



50°

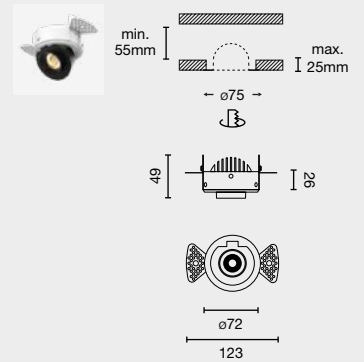
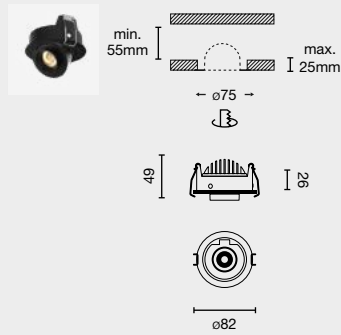

Family	Color T°	Beam Angle	Finish	Control System
0800 Alia 8W	927 2700K CRI90	1 15°	1 White	W CASAMBI
0801 Alia Trimless 8W	930 3000K CRI90	2 24°	2 Black	D DALI
		3 36°		C TRIAC
		5 50°		ON/OFF

0800 **927** **1** **1** **W**

Example **080092711W** — Alia Downlight 8W 2700K CRI90 15° White Casambi

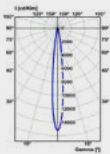

15°

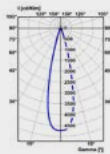

24°

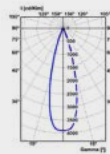

36°

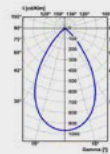

50°

Option	Color T°	CRI	Power	Lumen Output	Beam Angle
927	2700K	90	8W	687lm / 717lm / 1000lm / 831lm	15° / 24° / 36° / 50°
930	3000K	90	8W	708lm / 738lm / 1030lm / 856lm	15° / 24° / 36° / 50°
940	4000K	90	8W	731lm / 760lm / 1062lm / 884lm	15° / 24° / 36° / 50°



IZAR



The IZAR model is characterized by its adjustable tilt angle, allowing precise light direction to highlight specific elements. This accent lighting design is perfect for projects that require exact control of the light focus. With a modern and functional style, IZAR is the ideal solution for those looking to emphasize architectural or decorative details with efficient and flexible lighting.

El modelo IZAR se caracteriza por su capacidad de ajuste en el ángulo de inclinación, lo que permite dirigir la luz con precisión para resaltar elementos específicos. Este diseño de iluminación de acento es perfecto para proyectos que requieren un control exacto del enfoque lumínico. Con un estilo moderno y funcional, IZAR se convierte en una solución ideal para quienes buscan destacar detalles arquitectónicos o decorativos con una iluminación eficiente y flexible.

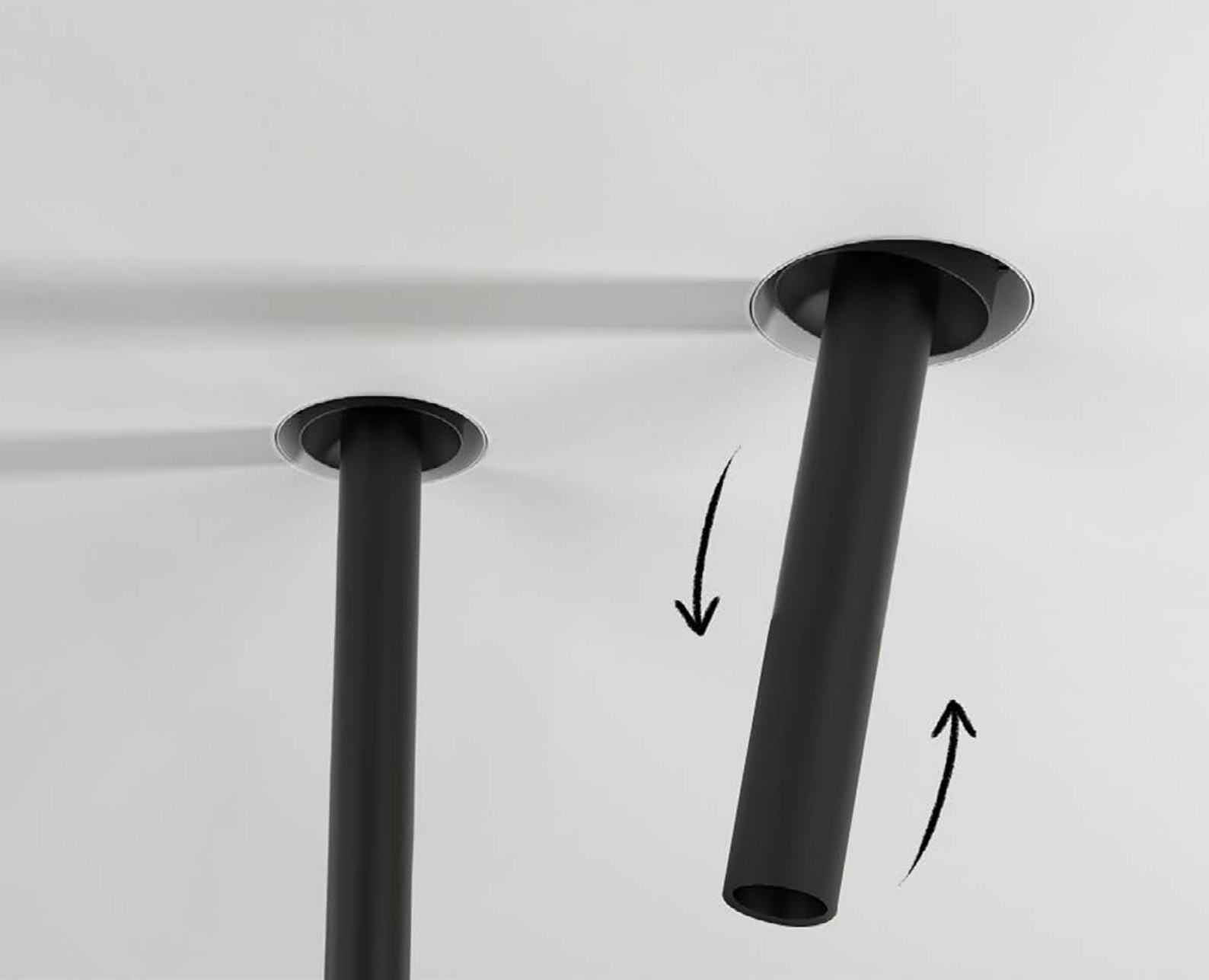



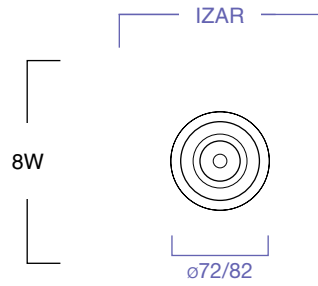

FINISH
Acabado

● **Black**
Negro

○ **White**
Blanco

COLOR TEMPERATURE
Temperatura de color

2700K CRI90

3000K CRI90

BEAM ANGLE
Ángulo de apertura

15°

CONTROL SYSTEM
Sistema de control



CASAMBI



Highlights

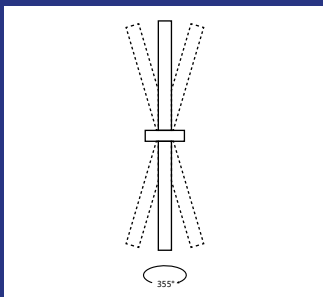

Diferent heights and angles
Diferentes alturas y ángulos



Several color temperatures
Varias temperaturas de color



Conectivity
Conectividad

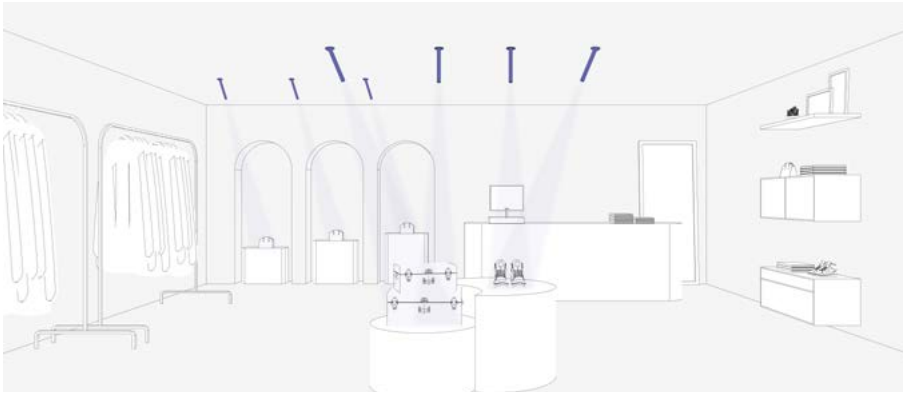

Retail



Residential

Beam Angle



15°

IZAR DOWNLIGHT

NEW

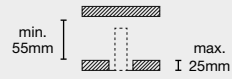

- incl.
- DIM
- 355°
- 50.000hs
L80 / B10
- MacAdam
3
- 220-
240V
- 650°C

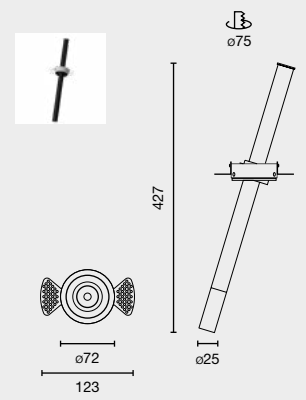
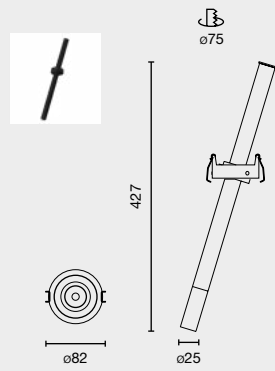

Family	Color T°	Beam Angle	Finish	Control System
0900 Izar 8W	927 2700K CRI90	1 15°	1 White	W CASAMBI
0901 Izar Trimless 8W	930 3000K CRI90		2 Black	D DALI
				C TRIAC
				ON/OFF

0900 **927** **1** **1** **W**

Example **090092711W** — Alia Downlight 8W 2700K CRI90 15° White Casambi

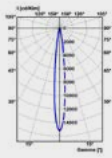

15°

Option	Color T°	CRI	Power	Lumen Output
927	2700K	90	8W	288lm
930	3000K	90	8W	235lm
940	4000K	90	8W	243lm



TULIPA is the ideal solution when light quality and great visual comfort are needed. Downlight with aluminium injection frame and high-quality finishes which, thanks to its cut-off and its integrated honeycomb, guarantees maximum visual comfort.

TULIPA es la solución ideal cuando se precisa calidad de luz y gran confort visual. Downlight con marco de inyección de aluminio y acabados de alta calidad que, gracias a su cut-off y su panel de abeja integrado, garantiza el máximo confort visual.



TULIPA





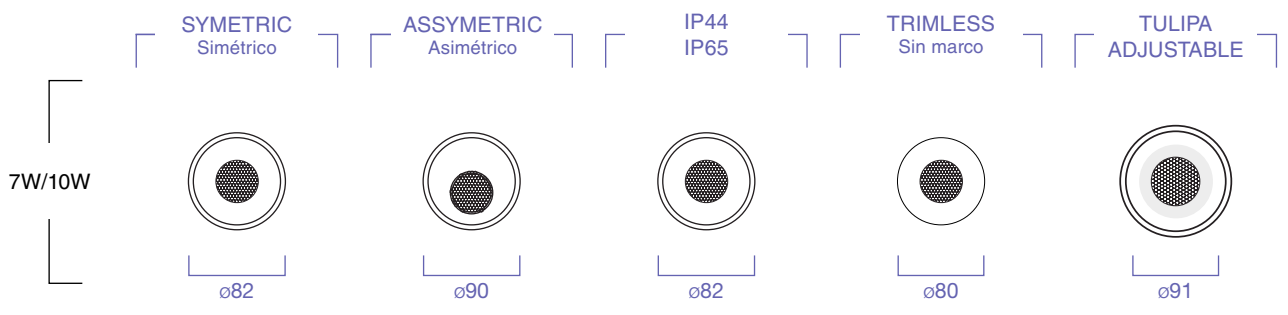

FINISH
Acabado

- Black**
Negro
- White**
Blanco

COLOR TEMPERATURE
Temperatura de color

- 2700K CRI90
- 3000K CRI90
- 4000K CRI90

BEAM ANGLE
Ángulo de apertura

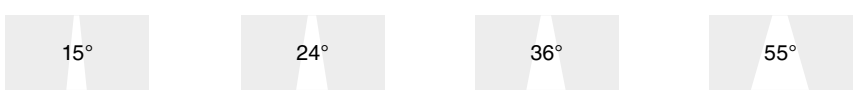

ACCESSORIES
Accesorios

- Supplementary
White Ring
- Supplementary
Black Ring

CONTROL SYSTEM
Sistema de control



Highlights

Optical block formed by a secondary aluminium injection reflector which at the same time functions as a recess ring, integrated honeycomb, along with a high-purity PMMA lens.

Bloque óptico formado por un reflector secundario de inyección de aluminio que a la vez ejerce de aro de empotramiento, panel de abeja integrado junto con una lente de PMMA de alta pureza.



Built-in Honeycomb
Panel de abeja incorporado



Symmetric / Asymmetric / Adjustable
Simétrico / Asimétrico / Orientable



Simple clipping system
Sistema de clipaje simple



Optional IP44/IP65
Opción IP44/ IP65



High CRI
Alto IRC



Several color temperatures
Varias temperaturas de color





**Supplementary
White Ring**

ø96 supplementary ring



**Supplementary
Black Ring**

ø96 supplementary ring

Accessories

**Supplementary
White Ring**

033500098

**Supplementary
Black Ring**

033500099



Residential



Office



Restaurant

Beam Angle



15°



24°

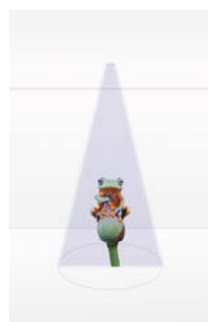

36°

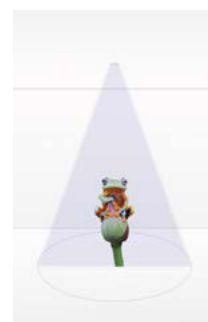

55°

TULIPA

incl. DIM 50.000hs L80 / B10 MacAdam 3 220-240V 50 / 60Hz 650°C

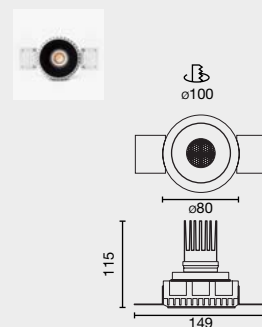
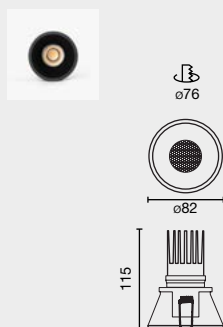

Family	Power	Color T°	Beam Angle	Finish	Control System
0335 Tulipa Trim	1 7W 350mA	927 2700K CRI90	1 15°	1 White	W CASAMBI
0337 Tulipa Trim IP44	2 10W 500mA	930 3000K CRI90	2 24°	2 Black	D DALI
0334 Tulipa Trim IP65		940 4000K CRI90	3 36°		C TRIAC
0338 Tulipa Trimless			5 55°		ON/OFF

0335 **1** **927** **1** **1** **W**

Example **0335192711W** — Tulipa trim 7W 350mA 2700K CRI90 15° White Casambi

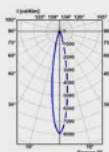

15°

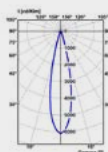

24°

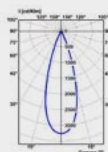

36°

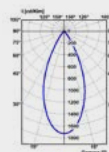

55°

Option	Color T°	CRI	Power	Lumen Output	Beam Angle
0335 / 0337 / 0338	2700K	90	7W 350mA	355lm / 387lm / 406lm / 313lm	15° / 24° / 36° / 55°
		90	10W 500mA	504lm / 550lm / 577lm / 445lm	15° / 24° / 36° / 55°
0335 / 0337 / 0338	3000K	90	7W 350mA	366lm / 399lm / 419lm / 323lm	15° / 24° / 36° / 55°
		90	10W 500mA	520lm / 567lm / 595lm / 459lm	15° / 24° / 36° / 55°
0335 / 0337 / 0338	4000K	90	7W 350mA	377lm / 411lm / 432lm / 333lm	15° / 24° / 36° / 55°
		90	10W 500mA	535lm / 584lm / 613lm / 472lm	15° / 24° / 36° / 55°

TULIPA ASYMMETRIC

incl. DIM 50.000hs L80 / B10 MacAdam 3 220-240V 50 / 60Hz 650°C

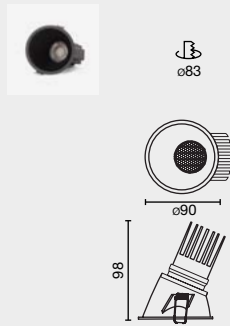

Family	Power	Color T°	Beam Angle	Finish	Control System
0336 Tulipa Asymmetric	1 7W 350mA	927 2700K CRI90	1 15°	1 White	W CASAMBI
	2 10W 500mA	930 3000K CRI90	2 24°	2 Black	D DALI
		940 4000K CRI90	3 36°		C TRIAC
			5 55°		ON/OFF

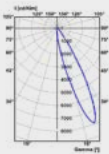

*15°

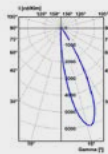

*24°

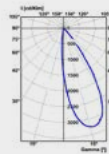

*36°

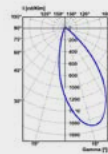

*55°

Option	Color T°	CRI	Power	Lumen Output	Beam Angle
0336	2700K	90	7W 350mA	333lm / 377lm / 465lm / 320lm	15° / 24° / 36° / 55°
		90	10W 500mA	472lm / 536lm / 660lm / 455lm	15° / 24° / 36° / 55°
0336	3000K	90	7W 350mA	343lm / 389lm / 479lm / 330lm	15° / 24° / 36° / 55°
		90	10W 500mA	487lm / 552lm / 680lm / 469lm	15° / 24° / 36° / 55°
0336	4000K	90	7W 350mA	353lm / 401lm / 493lm / 340lm	15° / 24° / 36° / 55°
		90	10W 500mA	502lm / 569lm / 701lm / 483lm	15° / 24° / 36° / 55°

*Beam angle with 30° inclination
*Ángulo con 30° inclinación

TULIPA ADJUSTABLE

incl. DIM 25° 50.000hs L80 / B10 MacAdam 3 220-240V 50 / 60Hz 650°C

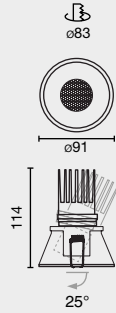

Family	Power	Color T°	Beam Angle	Finish	Control System
0339 Tulipa adjustable	1 7W 350mA	927 2700K CRI90	1 15°	1 White	W CASAMBI D DALI C TRIAC ON/OFF
	2 10W 500mA	930 3000K CRI90	2 24°	2 Black	
		940 4000K CRI90	3 36°		
			5 55°		

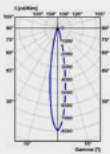

15°

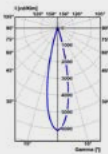

24°

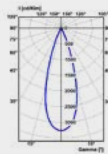

36°

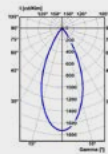

55°

Option	Color T°	CRI	Power	Lumen Output	Beam Angle
0339	2700K	90	7W 350mA	355lm / 387lm / 406lm / 313lm	15° / 24° / 36° / 55°
		90	10W 500mA	504lm / 550lm / 577lm / 445lm	15° / 24° / 36° / 55°
0339	3000K	90	7W 350mA	366lm / 399lm / 419lm / 323lm	15° / 24° / 36° / 55°
		90	10W 500mA	520lm / 567lm / 595lm / 459lm	15° / 24° / 36° / 55°
0339	4000K	90	7W 350mA	377lm / 411lm / 432lm / 333lm	15° / 24° / 36° / 55°
		90	10W 500mA	535lm / 584lm / 613lm / 472lm	15° / 24° / 36° / 55°



Size does matter. UNO has a design that is small in dimension and a large capacity to create environments with light with minimum visual invasion, both in the space and on the recess surface.

El tamaño sí importa. UNO presenta un diseño de reducidas dimensiones y una gran capacidad de crear entornos con luz con la mínima invasión visual, tanto en el espacio como en la superficie de empotramiento.



UNO





FINISH
Acabado

● **Black+Black**
Negro+Negro

◐ **Black+White**
Negro+Blanco

○ **White+White**
Blanco+Blanco

◑ **White+Black**
Blanco+Negro

◐◑ **Black+Gold**
Negro+Oro

◑◐ **White+Gold**
Blanco+Oro

COLOR TEMPERATURE
Temperatura de color

2700K CRI90

3000K CRI90

BEAM ANGLE
Ángulo de apertura

11°

24°

37°

ACCESSORIES
Accesorios



Honeycomb

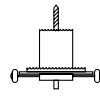

Trimless Tool

CONTROL SYSTEM
Sistema de control



Highlights



The size/flow ratio of its downlight and extractable projector versions makes it possible to fulfill the requirements needed for applications in hotels, restaurants and retail, as well as its domestic application.

La relación tamaño-flujo de sus versiones downlight y proyector extraíble hacen posible que, además de su aplicación doméstica, cumpla con las exigencias requeridas para aplicaciones en hoteles, restaurantes y retail.



Passive heat dissipation system
Sistema de disipación térmica pasiva

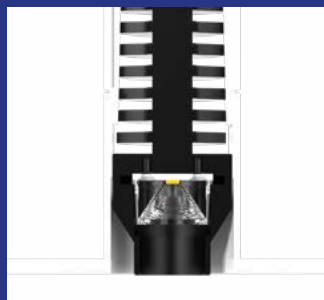

Glare control
Control de deslumbramiento

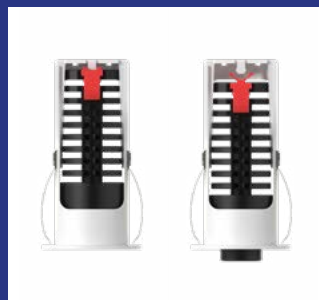

Removable downlight module
Módulo downlight extraíble a presión



Several color temperatures
Varias temperaturas de color

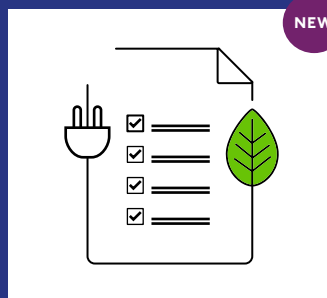

High Efficiency CRI90
Alta eficiencia





Honeycomb



Trimless Tool

Accessories

Honeycomb

35300099

Uno trimless tool

35300098

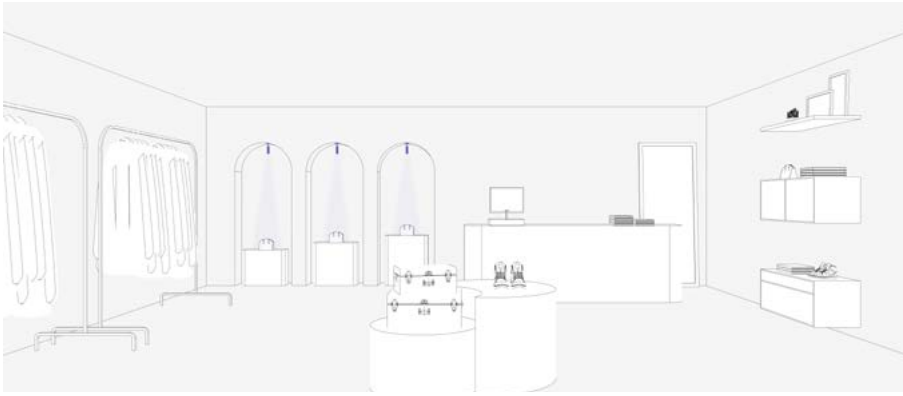

Retail



Restaurant



Residential

Beam Angle



11°



24°

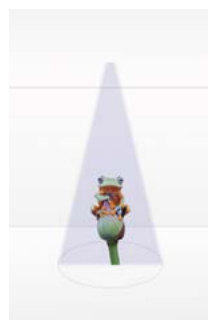

37°

UNO DOWNLIGHT 8W

incl. DIM 50.000hs L70 / B10 MacAdam 3 220-240V 50 / 60Hz 650°C

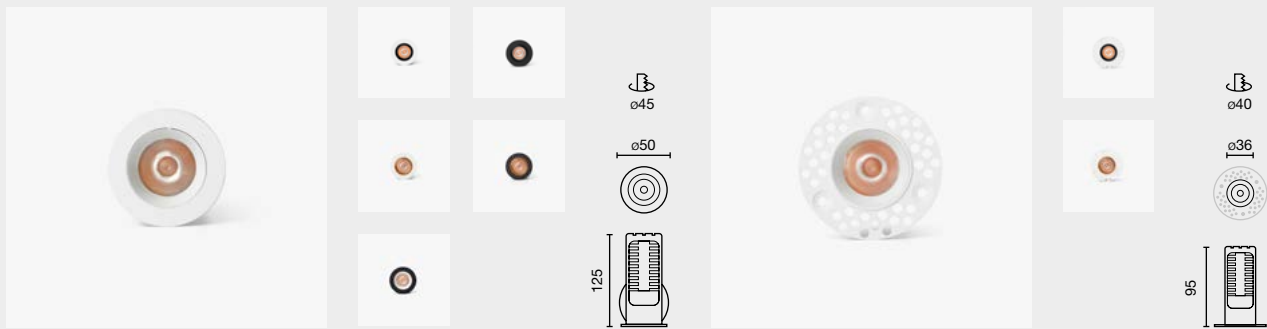

Family	Color T°	Beam Angle	Finish	Ring	Control System
0331 Uno Trim 8W	927 2700K CRI90	1 11°	1 White	1 White	D DALI
0332 Uno Trimless 8W	930 3000K CRI90	2 24°	2 Black	2 Black	ON/OFF
		3 37°		4 Gold	

0331 **927** **1** **1** **1** **D**

Example **0331927111W** — Uno trim 8W 2700K CRI90 11° White, White Ring Dali

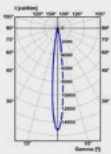

11°

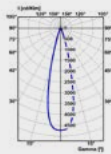

24°

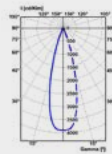

37°

Option	Color T°	CRI	Power	Lumen Output	Beam Angle
927	2700K	90	8W	347lm / 346lm / 331lm	11° / 24° / 37°
930	3000K	90	8W	358lm / 357lm / 341lm	11° / 24° / 37°

UNO PULLDOWN PROJECTOR 8W

incl. DIM 355° 90° 50.000hs L70 / B10 MacAdam 3 220-240V 50 / 60Hz 650°C

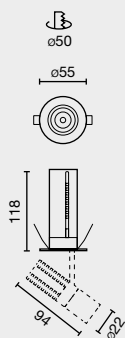
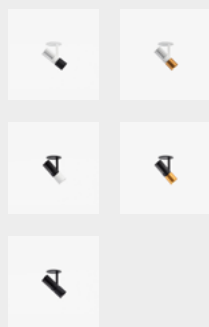

Family	Color T°	Beam Angle	Finish	Ring	Control System
0333 Uno Pulldown 8W	927 2700K CRI90	1 11°	1 White	1 White	D ON/OFF
	930 3000K CRI90	2 24°	2 Black	2 Black	
		3 37°		4 Gold	

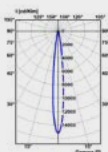

11°

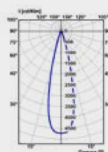

24°

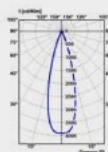

37°

Option	Color T°	CRI	Power	Lumen Output	Beam Angle
927	2700K	90	8W	736lm / 736lm / 704lm	11° / 24° / 37°
930	3000K	90	8W	759lm / 759lm / 725lm	11° / 24° / 37°

The KOPE downlight is the perfect solution for spaces with sloped ceilings or where precise light orientation is required. Its minimalist design makes it ideal for discreet integration into any environment. This versatile and compact downlight can be tilted and recessed according to lighting needs, providing complete control over the direction of light and adding functionality and elegance to any space.

El downlight KOPE es la solución perfecta para espacios con techos inclinados o donde se requiere una orientación precisa de la luz. Su diseño minimalista lo hace ideal para integrarse discretamente en cualquier entorno. Este downlight versátil y de dimensiones reducidas se puede inclinar y retraer según las necesidades de iluminación, brindando un control total sobre la dirección de la luz y dotando de funcionalidad y elegancia cualquier tipo de espacio.





KOPE



Kope 7W

Kope 13W

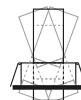
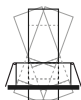

ø85

ø100

FINISH
Acabado

● **Black**
Negro

○ **White**
Blanco

COLOR TEMPERATURE
Temperatura de color

2700K CRI90

3000K CRI90

4000K CRI90

BEAM ANGLE
Ángulo de apertura

20°

36°

CONTROL SYSTEM
Sistema de control



CASAMBI

Highlights



With two sizes and powers, Kope stands out for its ability to be adjustable, as well as for its “up-down” movement. Ideal for sloped ceilings where the light beam is to be kept vertical, or for light points where an adjustable or directional beam is desired.

Con dos tamaños y potencias, Kope destaca por la posibilidad de ser orientable, así como del movimiento “up down”. Ideal para techos inclinados en los que lo que se quiera mantener el haz de luz en vertical, o para puntos de luz donde se busque un haz inclinable u orientable.



Consider the installation height in your project

Tenga en cuenta la altura de la instalación en su proyecto



High CRI Alto IRC



Several color temperatures Varias temperaturas de color



Possibility orientation, up down

Posibilidad orientación, subir y bajar



Restaurant



Home

Beam Angle



20°

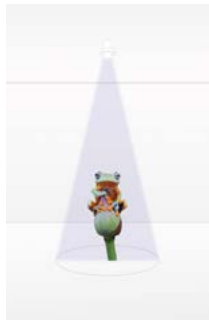

36°

KOPE

incl. DIM 50.000hs L70 / B10 MacAdam 3 220- 50/ 240V 60Hz 650°C

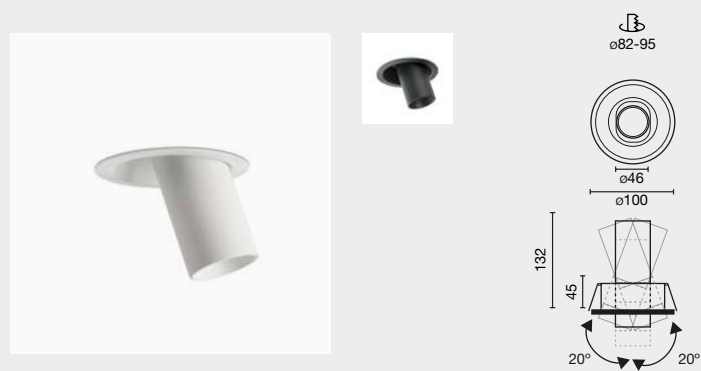
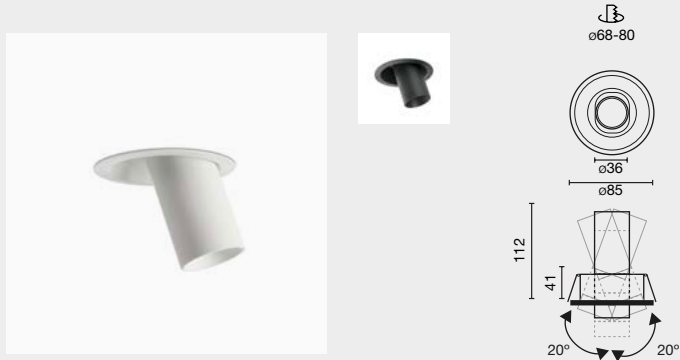

Family

Color T°

Beam Angle

Finish

Control System

0225 Kope 7W	927 2700K CRI90	2 20°	1 White	W CASAMBI
0226 Kope 13W	930 3000K CRI90	4 36°	2 Black	D DALI
	940 4000K CRI90			ON/OFF

0354

927

6

1

W

Example **0022592721W** — Kope 7W 2700K CRI90 20° White Casambi

Kope 7W

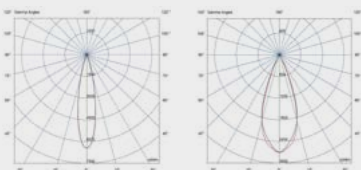

20°

36°

Kope 13W

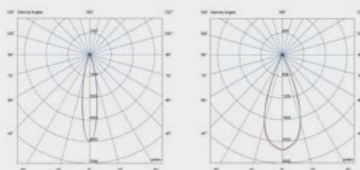

20°

36°

Option	Color T°	CRI	Power	Lumen Output	Beam Angle
927	2700K	90	7w	451/494	20°/36°
		90	13w	859/818	20°/36°
930	3000K	90	7w	465/495	20°/36°
		90	13w	886/837	20°/36°
940	4000K	90	7w	479/524	20°/36°
		90	13w	913/868	20°/36°



DEEP is a series of recessed light fixtures available in 3 sizes (S, M, L), two formats (round or square) and with or without frame. Its wide range of colour temperature, different optics and CRI options makes it a perfect option for commercial spaces, hotels, restaurants and retail. Its accessories enable better glare control and maximum visual comfort.







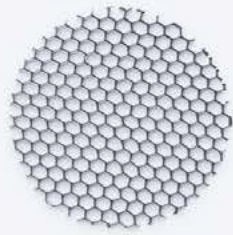

DEEP es una serie de luminarias empotradas disponible en 3 tamaños (S, M, L), dos formatos (redondo o cuadrado), y opción con marco y sin marco. Su amplia gama de temperatura de color, diversas ópticas y opciones de IRC la convierten en una opción perfecta para espacios comerciales, hoteles, restauración y retail. Sus accesorios permiten un mejor control del deslumbramiento, así como maximizar el confort visual.



DEEP



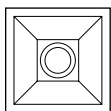
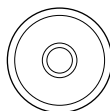
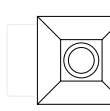
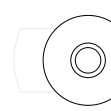

	TRIM Con marco		TRIMLESS Sin marco	
S 6 / 11W	 95x95	 ø93	 85x85	 ø83
M 12 / 18W	 115x115	 ø115	 103x103	 ø103
L 18 / 25 / 39W	 135x135	 ø135	 123x123	 ø123

FINISH
Acabado

● **Black**
Negro

○ **White**
Blanco

COLOR TEMPERATURE
Temperatura de color

2700K CRI90

3000K CRI90

4000K CRI90

FASHION

BEAM ANGLE
Ángulo de apertura

15°

36°

60°

ACCESSORIES
Accesorios



Honeycomb



Striped glass



Spread Glass

CONTROL SYSTEM
Sistema de control



CASAMBI



Highlights

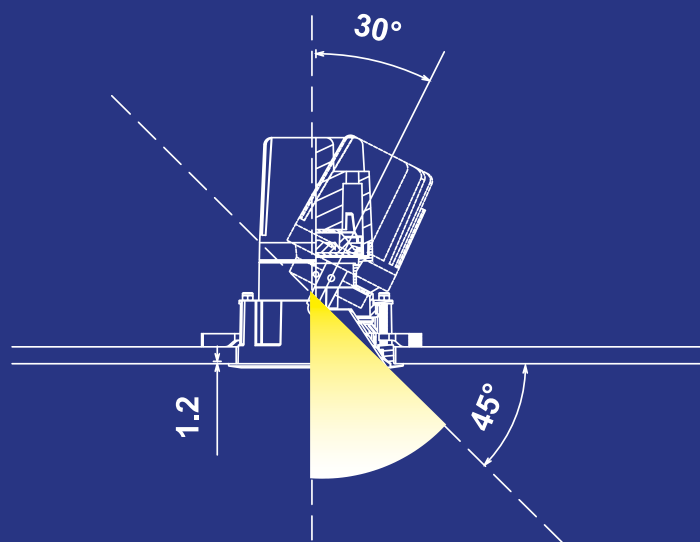

Different sizes
Diversos tamaños



High-quality materials
Materiales de alta calidad



Adjustable
Orientable



Several color temperatures
Varias temperaturas de color

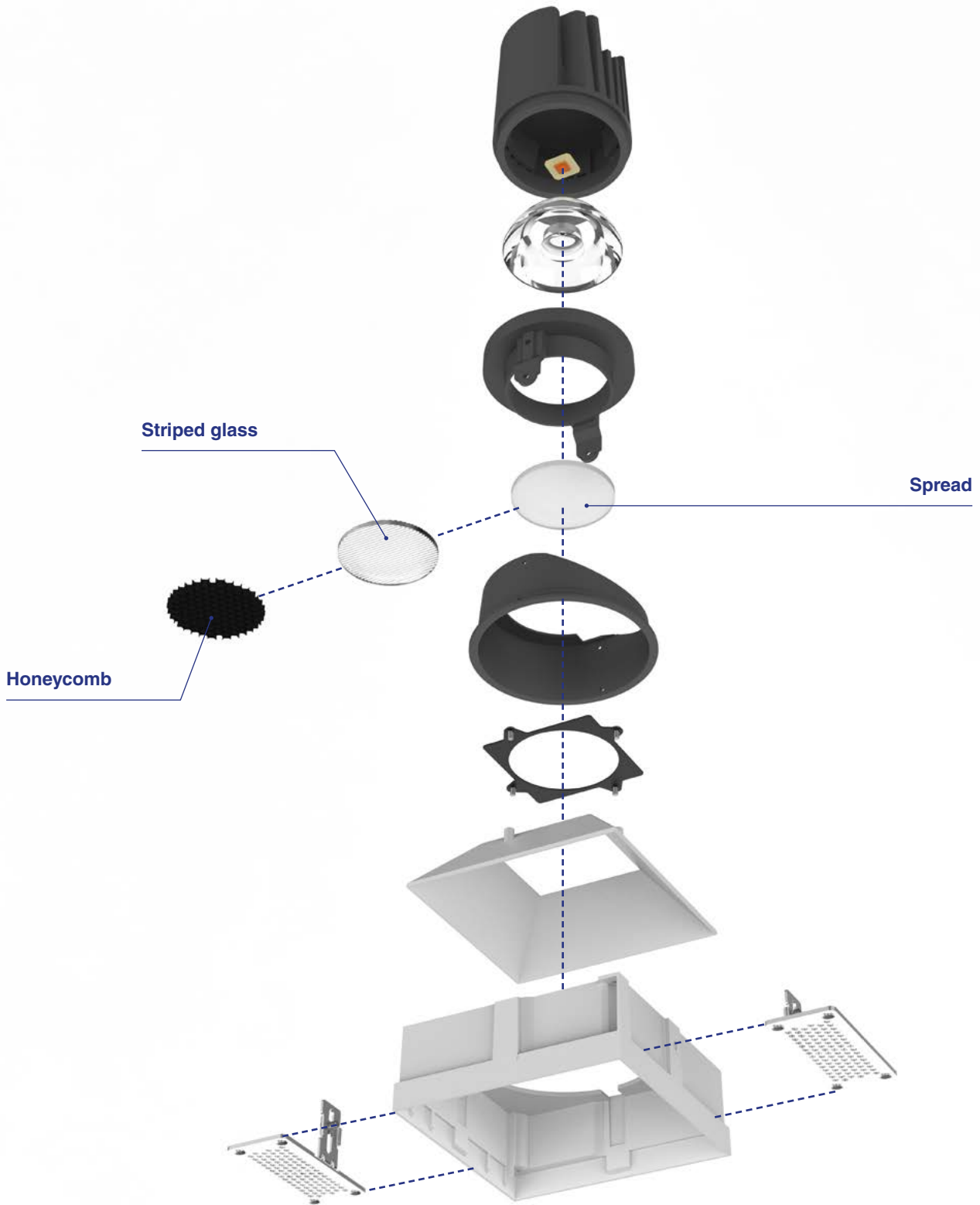



Honeycomb



Striped glass



Spread



Without accessory



Spread Glass



Striped Glass



Office



Restaurant

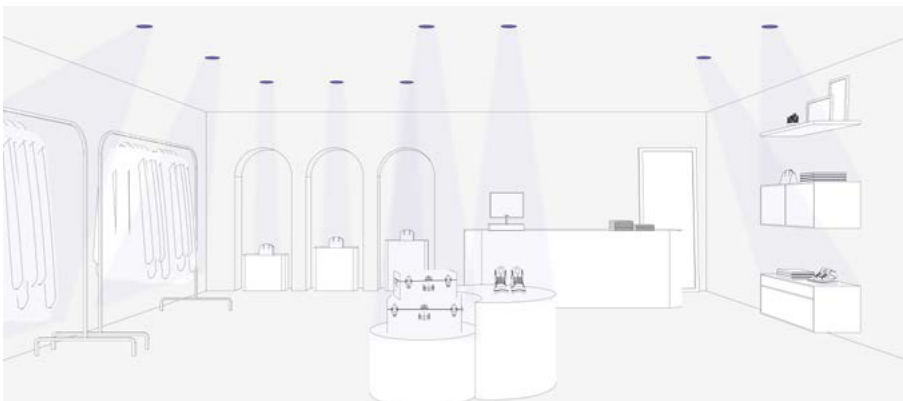

Retail

Beam Angle



15°



36°



60°

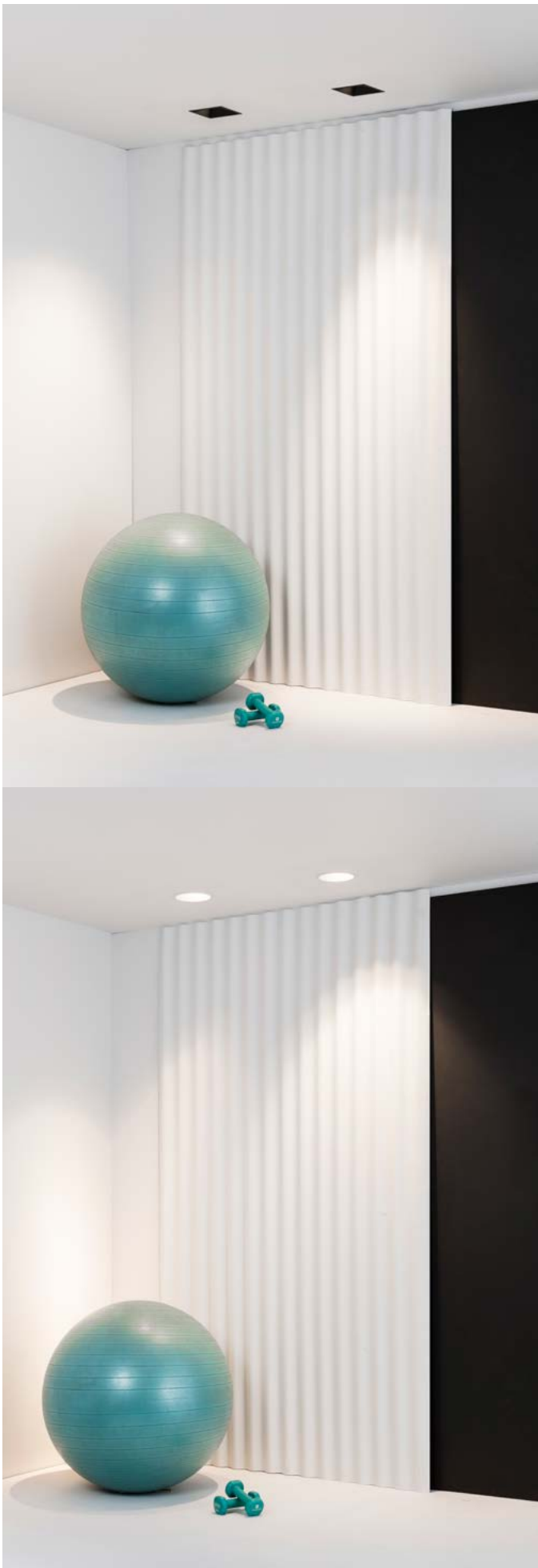



DEEP S Round

no incl. DIM 355° 30° 50.000hs L90 / B10 MacAdam 2 IP23 6W 11W 200mA 29V 350mA 30V 650°C

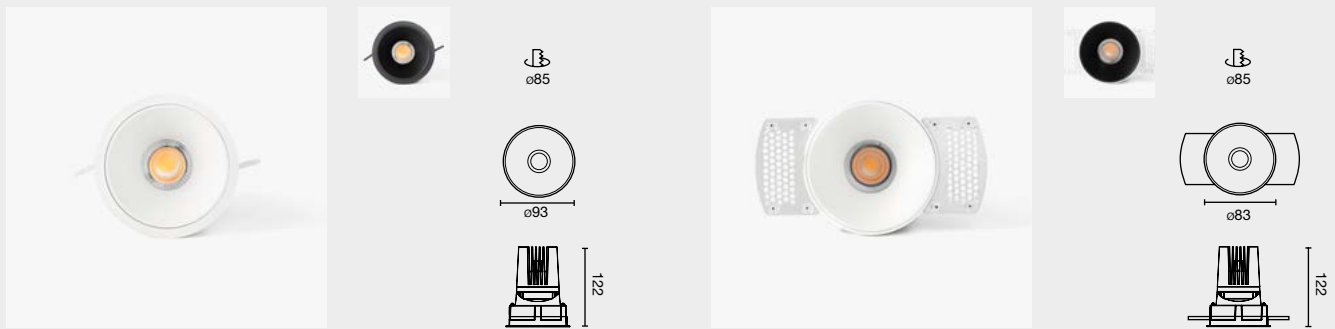

Family	Color T°	Beam Angle	Finish	Accessory
30135 Deep S Round	927 2700K CRI90	1 15°	1 White	No accessory
30235 Deep S Round Trimless	930 3000K CRI90	3 36°	2 Black	H Honeycomb
	940 4000K CRI90	6 60°		S Striped glass
				D Spread

30135 **827** **1** **1** **H**

Example **3013582711H** — Deep 60 Round 2700K 15° White Honeycomb

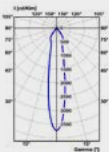

15°

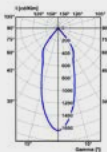

36°

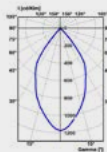

60°

Option	Color T°	CRI	Power	Lumen Output	Beam Angle
927	2700K	90	6W	291 / 352 / 287lm	15° / 36° / 60°
			11W	466 / 514 / 453lm	
930	3000K	90	6W	301 / 363 / 296lm	15° / 36° / 60°
			11W	481 / 530 / 467lm	
940	4000K	90	6W	310 / 374 / 305lm	15° / 36° / 60°
			11W	495 / 546 / 481lm	

Driver not included. See recommended drivers on page 490-491
Driver no incluido. Ver drivers recomendados en página 490-491

DEEP S Square

no incl. DIM 355° 30° 50.000hs L90 / B10 MacAdam 2 IP23 6W 11W 200mA 29V 350mA 30V 650°C

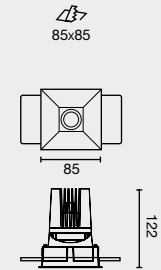
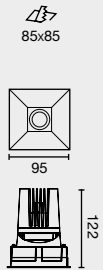

Family	Color T°	Beam Angle	Finish	Accessory
30335 Deep S Square	927 2700K CRI90	1 15°	1 White	No accessory
30435 Deep S Square Trimless	930 3000K CRI90	3 36°	2 Black	H Honeycomb
	940 4000K CRI90	6 60°		S Striped glass
				D Spread

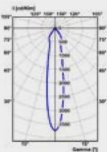

15°

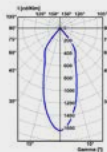

36°

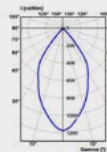

60°

Option	Color T°	CRI	Power	Lumen Output	Beam Angle
927	2700K	90	6W	291 / 352 / 287lm	15° / 36° / 60°
			11W	466 / 514 / 453lm	15° / 36° / 60°
930	3000K	90	6W	301 / 363 / 296lm	15° / 36° / 60°
			11W	481 / 530 / 467lm	15° / 36° / 60°
940	4000K	90	6W	310 / 374 / 305lm	15° / 36° / 60°
			11W	495 / 546 / 481lm	15° / 36° / 60°

Driver not included. See recommended drivers on page 490-491
Driver no incluido. Ver drivers recomendados en página 490-491

DEEP M Round

no incl. DIM 355° 30° 50.000hs L90 / B10 MacAdam 2 IP23 12W 350mA 34V 18W 500mA 36V 650°C

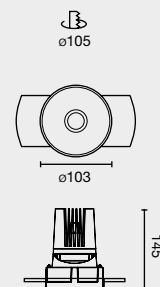
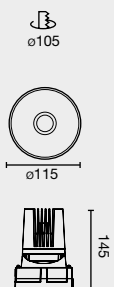

Family

Color T°

Beam Angle

Finish

Accessory

30550 Deep M Round	927 2700K CRI90	1 15°	1 White	No accessory
30650 Deep M Round Trimless	930 3000K CRI90	3 36°	2 Black	H Honeycomb
	940 4000K CRI90	6 60°		S Striped glass
				D Spread

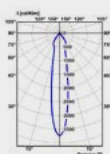

15°

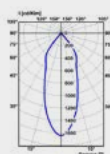

36°

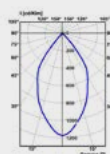

60°

Option	Color T°	CRI	Power	Lumen Output	Beam Angle
927	2700K	90	12W	1067 / 920 / 764lm	15° / 36° / 50°
			18W	1217 / 1290 / 1040lm	15° / 36° / 50°
930	3000K	90	12W	110 / 949 / 788lm	15° / 36° / 50°
			18W	1255 / 1330 / 1073lm	15° / 36° / 50°
940	4000K	90	12W	1133 / 977 / 811lm	15° / 36° / 50°
			18W	1292 / 1369 / 1105lm	15° / 36° / 50°

Driver not included. See recommended drivers on page 490-491
Driver no incluido. Ver drivers recomendados en página 490-491

DEEP M Square

no incl. DIM 355° 30° 50.000hs L90 / B10 MacAdam 2 IP23 12W 350mA 34V 18W 500mA 36V 650°C



105x105



105x105

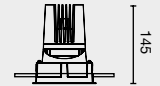
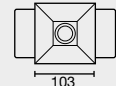

Family

Color T°

Beam Angle

Finish

Accessory

30750 Deep M Square	927 2700K CRI90	1 15°	1 White	No accessory
30850 Deep M Square Trimless	930 3000K CRI90	3 36°	2 Black	H Honeycomb
	940 4000K CRI90	6 60°		S Striped glass
				D Spread

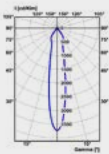

15°

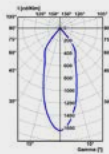

36°

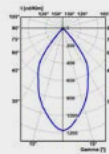

60°

Option	Color T°	CRI	Power	Lumen Output	Beam Angle
927	2700K	90	12W	1067 / 920 / 764lm	15° / 36° / 50°
			18W	1217 / 1290 / 1040lm	15° / 36° / 50°
930	3000K	90	12W	110 / 949 / 788lm	15° / 36° / 50°
			18W	1255 / 1330 / 1073lm	15° / 36° / 50°
940	4000K	90	12W	1133 / 977 / 811lm	15° / 36° / 50°
			18W	1292 / 1369 / 1105lm	15° / 36° / 50°

Driver not included. See recommended drivers on page 490-491
Driver no incluido. Ver drivers recomendados en página 490-491

DEEP L Round

no incl. DIM 355° 30° 50.000hs L90 / B10 MacAdam 2 IP23 18W 500mA 34V 25W 700mA 35V 39W 1050mA 37V 650°C

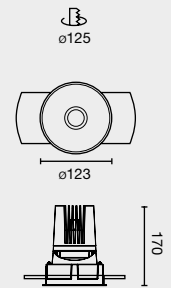

Family	Color T°	Beam Angle	Finish	Accessory
30910 Deep L Round	927 2700K CRI90	1 15°	1 White	No accessory
31010 Deep L Round Trimless	930 3000K CRI90	3 36°	2 Black	H Honeycomb
	940 4000K CRI90	6 60°		S Striped glass
	941 Fashion CRI95			D Spread

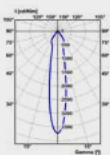

15°

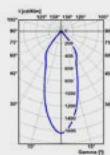

36°

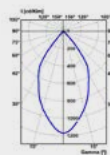

60°

Option	Color T°	CRI	Power	Lumen Output	Beam Angle
927	2700K	90	18W	1420 / 1487 / 1248lm	15° / 36° / 60°
			25W	1923 / 1990 / 1668lm	15° / 36° / 60°
			39W	2551 / 2845 / 2361lm	15° / 36° / 60°
930	3000K	90	18W	1464 / 1534 / 1287lm	15° / 36° / 60°
			25W	1983 / 2052 / 1720lm	15° / 36° / 60°
			39W	2630 / 2934 / 2435lm	15° / 36° / 60°
940	4000K	90	18W	1507 / 1580 / 1325lm	15° / 36° / 60°
			25W	2042 / 2113 / 1771lm	15° / 36° / 60°
			39W	2708 / 3022 / 2508lm	15° / 36° / 60°

Driver not included. See recommended drivers on page 490-491
Driver no incluido. Ver drivers recomendados en página 490-491

DEEP L Square

no incl. DIM 355° 30° 50.000hs L90 / B10 MacAdam 2 IP23 18W 500mA 34V 25W 700mA 35V 39W 1050mA 37V 650°C



125x125



125x125

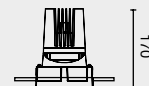
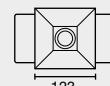

Family

Color T°

Beam Angle

Finish

Accessory

31110 Deep L Square	927 2700K CRI90	1 15°	1 White	No accessory
31210 Deep L Square Trimless	930 3000K CRI90	3 36°	2 Black	H Honeycomb
	940 4000K CRI90	6 60°		S Striped glass
	941 Fashion CRI95			D Spread

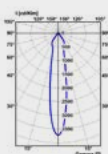

15°

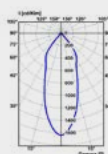

36°

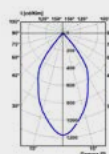

60°

Option	Color T°	CRI	Power	Lumen Output	Beam Angle
927	2700K	90	18W	1420 / 1487 / 1248lm	15° / 36° / 60°
			25W	1923 / 1990 / 1668lm	15° / 36° / 60°
			39W	2551 / 2845 / 2361lm	15° / 36° / 60°
930	3000K	90	18W	1464 / 1534 / 1287lm	15° / 36° / 60°
			25W	1983 / 2052 / 1720lm	15° / 36° / 60°
			39W	2630 / 2934 / 2435lm	15° / 36° / 60°
940	4000K	90	18W	1507 / 1580 / 1325lm	15° / 36° / 60°
			25W	2042 / 2113 / 1771lm	15° / 36° / 60°
			39W	2708 / 3022 / 2508lm	15° / 36° / 60°

Driver not included. See recommended drivers on page 490-491
Driver no incluido. Ver drivers recomendados en página 490-491

A collection of downlights with infinite options of sizes, formats, finishes and light angles. All this and much more in the palm of your hand.

Una colección de downlights con infinitas opciones de tamaños, formatos, acabados y ángulos de apertura. Todo esto y mucho más en la palma de tu mano.



TROOP

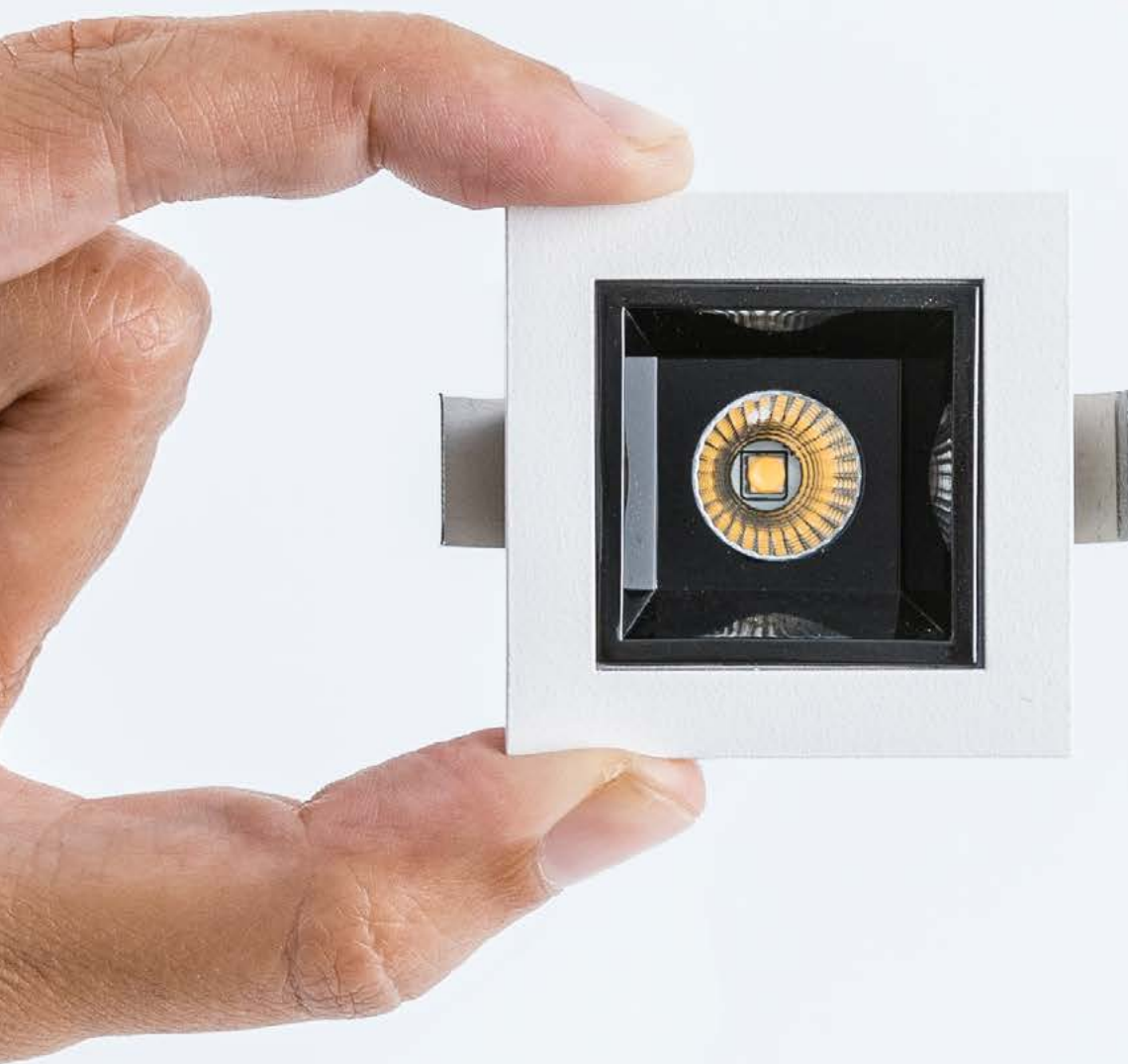



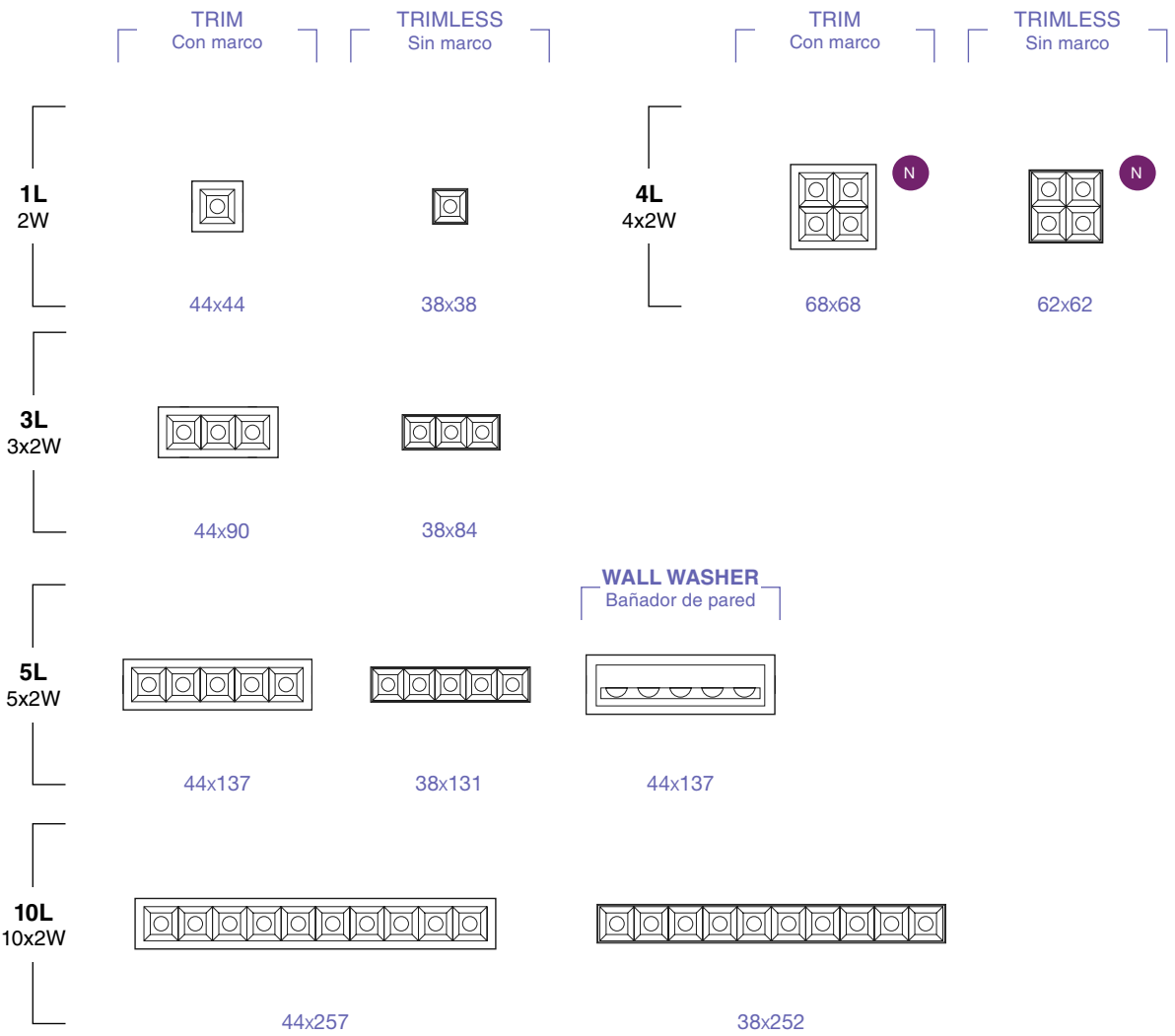

FINISH
Acabado

● **Black+Black**
Negro+Negro

◐ **Black+White**
Negro+Blanco

○ **White+White**
Blanco+Blanco

◑ **White+Black**
Blanco+Negro

◐ **Black+Gold**
Negro+Oro

◑ **White+Gold**
Blanco+Oro

COLOR TEMPERATURE
Temperatura de color

2700K CRI90

3000K CRI90

4000K CRI90

BEAM ANGLE
Ángulo de apertura

15°

36°

48°

CONTROL SYSTEM
Sistema de control



CASAMBI



Highlights

Anti-glare optics
Óptica antideslumbrate

UGR

Reflector with dark light technology
Reflector con tecnología dark light

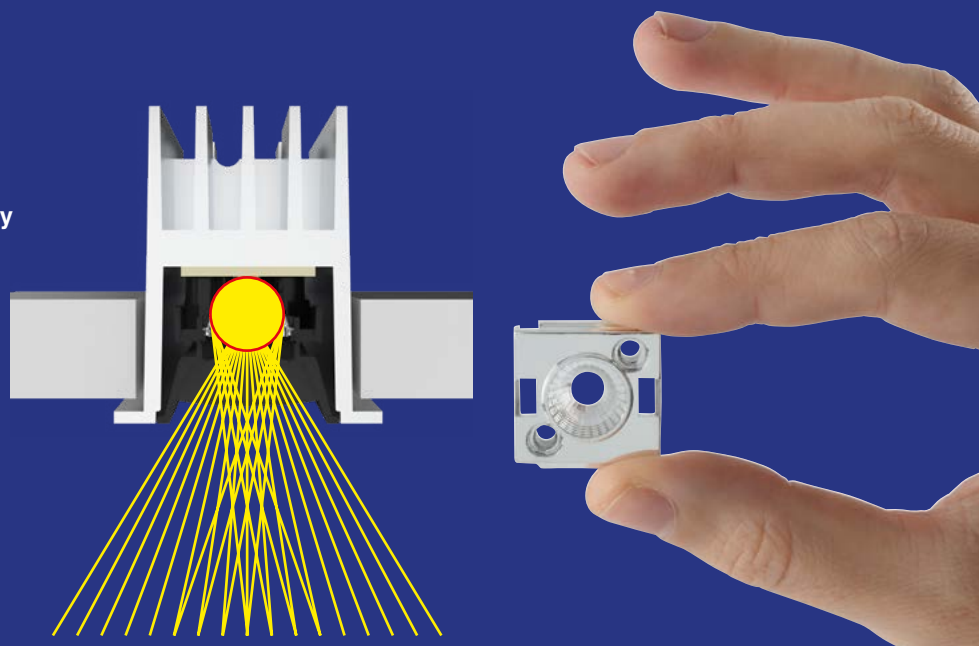

Different sizes & finishes
Diversos tamaños y acabados



Linear design with circular light effect
Diseño lineal con efecto lumínico circular



Wall washer version
Versión bañador de pared



Several color temperatures
Varias temperaturas de color



Residential



Restaurant

Beam Angle

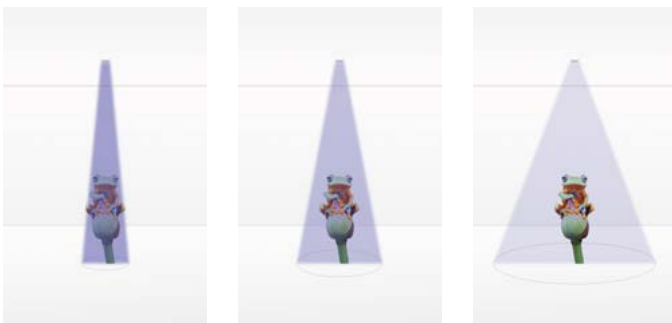

15°

36°

48°



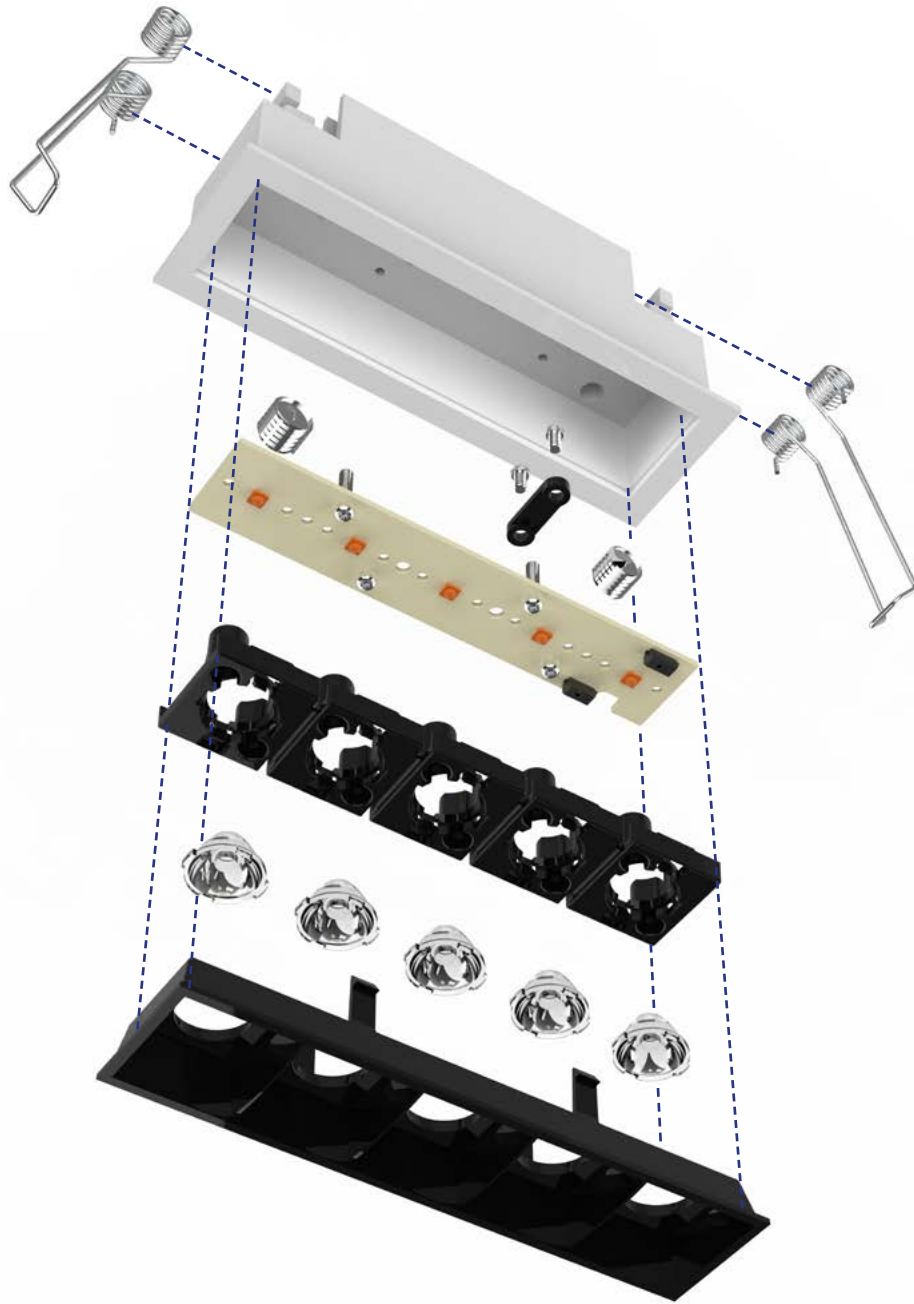

TROOP 1L

no incl. DIM 50.000hs L70 / B10 MacAdam 3 700mA 2.85V 650°C UGR <16



Family	Color T°	Beam Angle	Trim	Anti-Glare
43700 Troop Trim 2W	927 2700K CRI90	1 15°	1 White	1 White
	930 3000K CRI90	3 36°	2 Black	2 Black
	940 4000K CRI90	4 48°		4 Gold
43704 Troop Trimless 2W	927 2700K CRI90	1 15°	0 Trimless	1 White
	930 3000K CRI90	3 36°		2 Black
	940 4000K CRI90	4 48°		4 Gold

43700 927 1 1 1

Example **43700927111** — Troop Trim 2W 2700K 15° White White

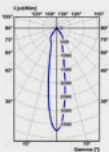

15°

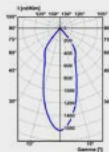

36°

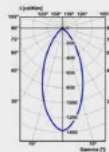

48°

Option	Color T°	CRI	Power	Lumen Output	Beam Angle
927	2700K	90	2W	160lm / 163lm / 166lm	15° / 36° / 48°
930	3000K	90	2W	165lm / 168lm / 171lm	15° / 36° / 48°
940	4000K	90	2W	170lm / 173lm / 176lm	15° / 36° / 48°

Driver not included. See recommended drivers on page 490-491
Driver no incluido. Ver drivers recomendados en página 490-491

TROOP 3L

no incl. DIM 50.000hs L70 / B10 MacAdam 3 700mA 8.61V 650°C UGR <16



Family	Color T°	Beam Angle	Trim	Anti-Glare
43701 Troop Trim 3x2W	927 2700K CRI90	1 15°	1 White	1 White
	930 3000K CRI90	3 36°	2 Black	2 Black
	940 4000K CRI90	4 48°		4 Gold
43705 Troop Trimless 3x2W	927 2700K CRI90	1 15°	0 Trimless	1 White
	930 3000K CRI90	3 36°		2 Black
	940 4000K CRI90	4 48°		4 Gold

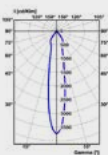

15°

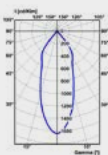

36°

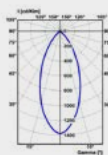

48°

Option	Color T°	CRI	Power	Lumen Output	Beam Angle
927	2700K	90	3x2W	425lm / 650lm / 493lm	15° / 36° / 48°
930	3000K	90	3x2W	438lm / 670lm / 508lm	15° / 36° / 48°
940	4000K	90	3x2W	451lm / 690lm / 523lm	15° / 36° / 48°

Driver not included. See recommended drivers on page 490-491
 Driver no incluido. Ver drivers recomendados en página 490-491

TROOP 4L

NEW

no incl. DIM 50.000hs L70 / B10 MacAdam 3 700mA 14.28V 650°C UGR <16

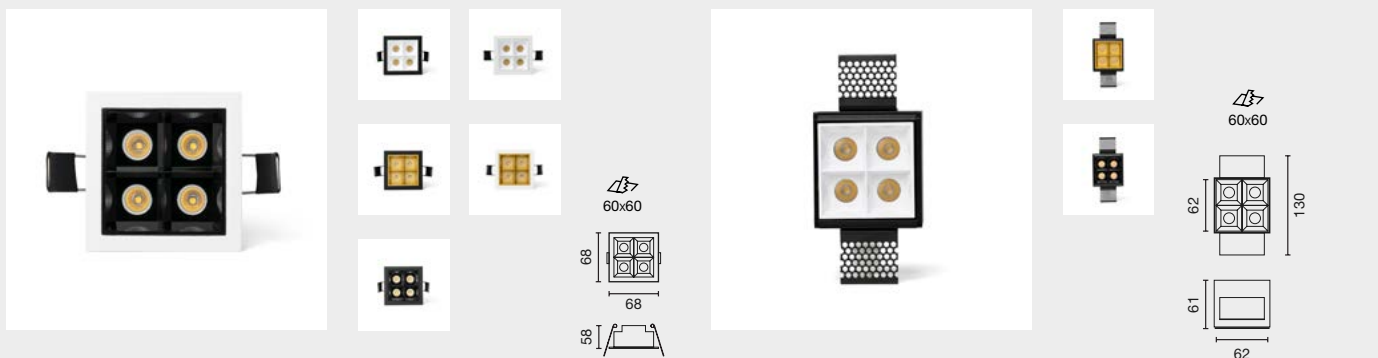

Family	Color T°	Beam Angle	Trim	Anti-Glare
43712 Troop Trim 4x2W	927 2700K CRI90	1 15°	1 White	1 White
	930 3000K CRI90	3 36°	2 Black	2 Black
	940 4000K CRI90	4 48°		4 Gold
43713 Troop Trimless 4x2W	927 2700K CRI90	1 15°	0 Trimless	1 White
	930 3000K CRI90	3 36°		2 Black
	940 4000K CRI90	4 48°		4 Gold

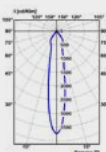

15°

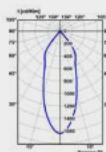

36°

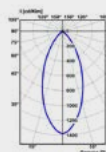

48°

Option	Color T°	CRI	Power	Lumen Output	Beam Angle
927	2700K	90	4x2W	488lm / 701lm / 708lm	15° / 36° / 48°
930	3000K	90	4x2W	503lm / 723lm / 730lm	15° / 36° / 48°
940	4000K	90	4x2W	712lm / 891lm / 878lm	15° / 36° / 48°

Driver not included. See recommended drivers on page 490-491
 Driver no incluido. Ver drivers recomendados en página 490-491

TROOP 5L

no incl. DIM 50.000hs L70 / B10 MacAdam 3 700mA 14.28V 650°C UGR <16

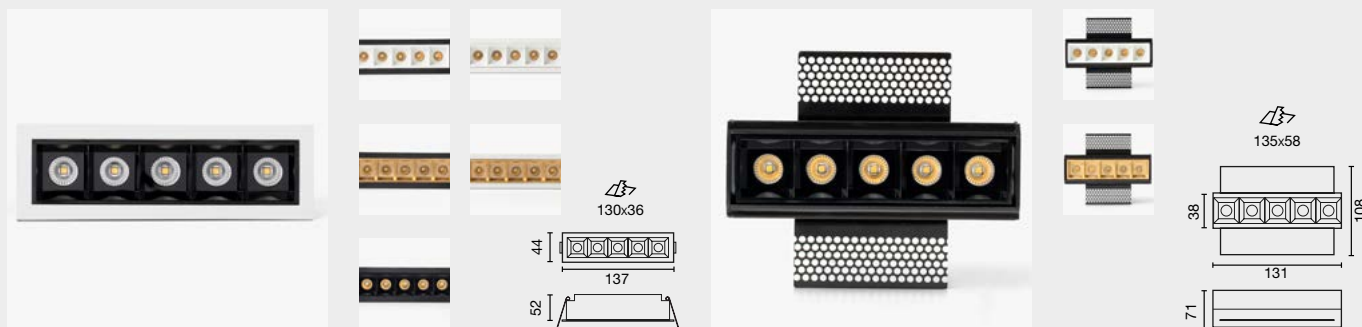

Family	Color T°	Beam Angle	Trim	Anti-Glare
43702 Troop Trim 5x2W	927 2700K CRI90	1 15°	1 White	1 White
	930 3000K CRI90	3 36°	2 Black	2 Black
	940 4000K CRI90	4 48°		4 Gold
43706 Troop Trimless 5x2W	927 2700K CRI90	1 15°	0 Trimless	1 White
	930 3000K CRI90	3 36°		2 Black
	940 4000K CRI90	4 48°		4 Gold

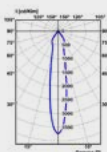

15°

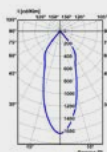

36°

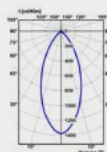

48°

Option	Color T°	CRI	Power	Lumen Output	Beam Angle
927	2700K	90	5x2W	672lm / 841lm / 828lm	15° / 36° / 48°
930	3000K	90	5x2W	692lm / 866lm / 853lm	15° / 36° / 48°
940	4000K	90	5x2W	712lm / 891lm / 878lm	15° / 36° / 48°

Driver not included. See recommended drivers on page 490-491
 Driver no incluido. Ver drivers recomendados en página 490-491

TROOP WALL WASHER

no incl. DIM 50.000hs L70 / B10 MacAdam 3 700mA 14.28V 650°C UGR <16

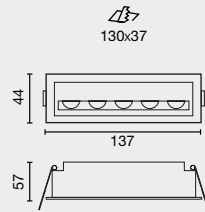

Family	Color T°	Beam Angle	Trim	Anti-Glare
43710 Troop Wall Washer 5x2W	927 2700K CRI90	0 Asymmetric	1 White	1 White
	930 3000K CRI90		2 Black	2 Black
	940 4000K CRI90			

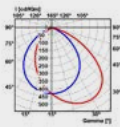

90°

Option	Color T°	CRI	Power	Lumen Output	Beam Angle
927	2700K	90	5x2W	519lm	90°
930	3000K	90	5x2W	535lm	90°
940	4000K	90	5x2W	551lm	90°

Driver not included. See recommended drivers on page 490-491
 Driver no incluido. Ver drivers recomendados en página 490-491

TROOP 10L

no incl. DIM 50.000hs L70 / B10 MacAdam 3 700mA 28.57V 650°C UGR <16

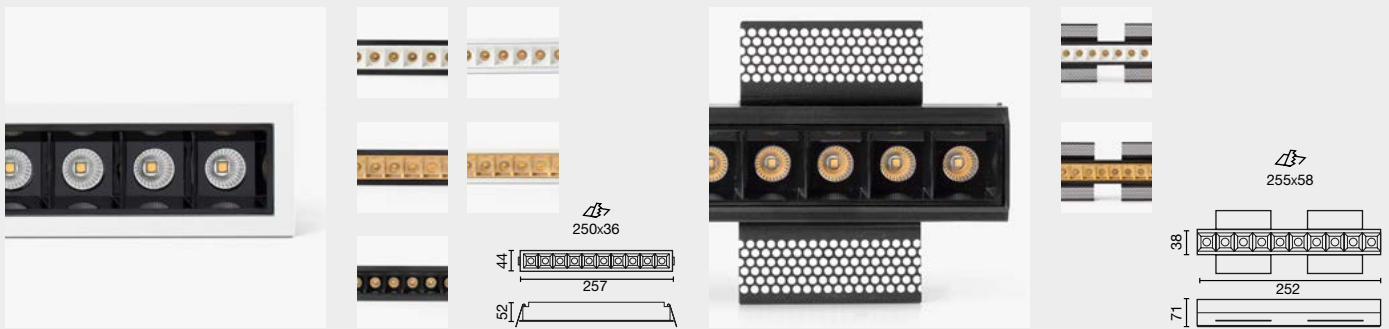

Family	Color T°	Beam Angle	Trim	Anti-Glare
43703 Troop Trim 10x2W	927 2700K CRI90	1 15°	1 White	1 White
	930 3000K CRI90	3 36°	2 Black	2 Black
	940 4000K CRI90	4 48°		4 Gold
43707 Troop Trimless 10x2W	927 2700K CRI90	1 15°	0 Trimless	1 White
	930 3000K CRI90	3 36°		2 Black
	940 4000K CRI90	4 48°		4 Gold

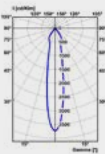

15°

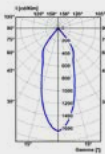

36°

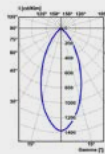

48°

Option	Color T°	CRI	Power	Lumen Output	Beam Angle
927	2700K	90	10x2W	1379lm / 1681lm / 1755lm	15° / 36° / 48°
930	3000K	90	10x2W	1422lm / 1733lm / 1809lm	15° / 36° / 48°
940	4000K	90	10x2W	1465lm / 1785lm / 1863lm	15° / 36° / 48°

Driver not included. See recommended drivers on page 490-491
 Driver no incluido. Ver drivers recomendados en página 490-491



KIMO

NEW



KIMO is a downlight of up to 30W, designed for both accent and general lighting. It is ideal for illuminating spaces with high ceilings, such as car dealerships or entrance halls, providing efficient and powerful lighting to enhance large areas. KIMO combines functionality with versatility, making it a perfect choice for spaces that demand performance

KIMO es un downlight de hasta 30W, diseñado tanto para iluminación de acento como general. Es ideal para iluminar espacios con techos altos, como concesionarios o halls de entrada, proporcionando una iluminación eficiente y potente para realzar grandes áreas. KIMO combina funcionalidad y versatilidad, siendo la elección perfecta para espacios que requieren un rendimiento destacado.



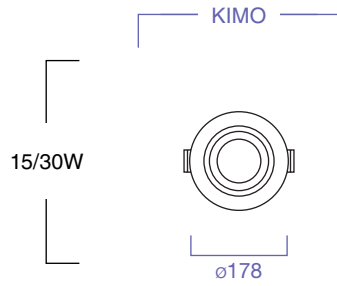

FINISH
Acabado

● **Black**
Negro

○ **White**
Blanco

COLOR TEMPERATURE
Temperatura de color

2700K CRI90

3000K CRI90

4000K CRI90

BEAM ANGLE
Ángulo de apertura

12°

36°

60°

24°

CONTROL SYSTEM
Sistema de control



CASAMBI



Highlights

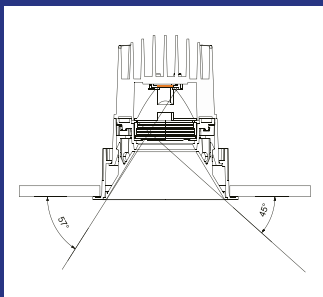

Visual Confort
Confort visual



Conectivity
Conectividad



Several color temperatures
Varias temperaturas de color



Residential



Office

Beam Angle



12°



24°

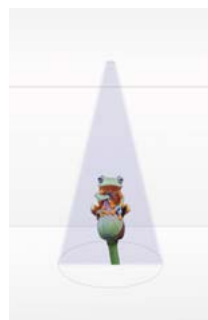

36°



60°

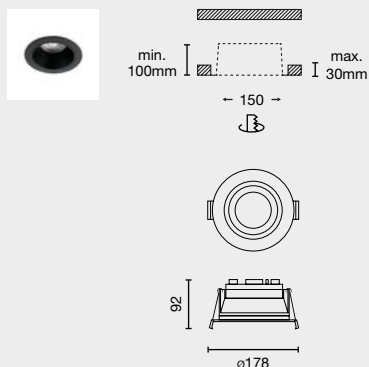

Family	Power	Color T°	Beam Angle	Finish	Control System
0360 Kimo	1 15W	927 2700K CRI90	1 15°	1 White	W CASAMBI
	2 30W	930 3000K CRI90	2 24°	2 Black	D BALI
		940 4000K CRI90	3 36°		C TRIAC
			6 60°		ON/OFF
0360	1	927	1	1	W

Example **0360192711W** — Kimo 15W 2700K CRI90 15° White Casambi

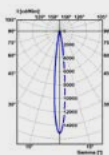

15°

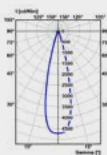

24°

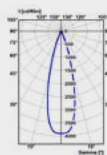

36°

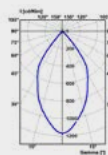

60°

Option	Color T°	CRI	Power	Lumen Output	Beam Angle
927	2700K	90	15W	1388lm / 1167lm / 1905lm / 1172lm	15° / 24° / 36° / 50°
			30W	2668lm / 2245lm / 2106lm / 2253lm	15° / 24° / 36° / 50°
930	3000K	90	15W	1431lm / 1111lm / 1042lm / 1115lm	15° / 24° / 36° / 50°
			30W	2751lm / 2314lm / 2171lm / 2323lm	15° / 24° / 36° / 50°
940	3000K	90	15W	1473lm / 1239lm / 1163lm / 1244lm	15° / 24° / 36° / 50°
			30W	2834lm / 2383lm / 2236lm / 2393lm	15° / 24° / 36° / 50°





KOBO

The KOBO downlight is a robust and reliable solution, with an IP67 rating, making it ideal for applications in hospitals and industries where resistance and durability are crucial. With two available beam angles, it can adapt to a wide range of lighting needs, from general illumination to specific tasks. Its solid design and features ensure high performance in demanding environments where light quality is essential.

El downlight KOBO es una solución robusta y confiable, con clasificación IP67 que lo hace ideal para aplicaciones en hospitales e industrias donde la resistencia y la durabilidad son fundamentales. Con dos ángulos de apertura disponibles, se adapta a un sinfín de necesidades de iluminación, desde iluminación general hasta tareas específicas. Su diseño sólido y sus prestaciones garantizan un alto rendimiento en entornos exigentes donde la calidad de la luz es esencial.



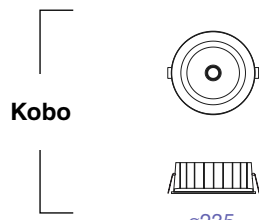

Kobo

ø235

FINISH
Acabado

White
Blanco

COLOR TEMPERATURE
Temperatura de color

2700K CRI90

3000K CRI90

4000K CRI90

2700-6500K

BEAM ANGLE
Ángulo de apertura

60°

100°

CONTROL SYSTEM
Sistema de control



CASAMBI

Highlights

With two options for beam angles, a UGR below 19, and an IP67 protection rating, this downlight becomes the ideal choice for hospital environments. The Tunable White version provides the flexibility to offer circadian cycle lighting.

Con dos opciones de ángulos de apertura, un UGR inferior a 19 y un grado de protección IP67, este downlight se convierte en la opción ideal para entornos hospitalarios. La versión de Tunable White proporciona la flexibilidad de ofrecer iluminación de ciclo circadiano.



IP65
IP65



High CRI
Alto IRC



Tunable White

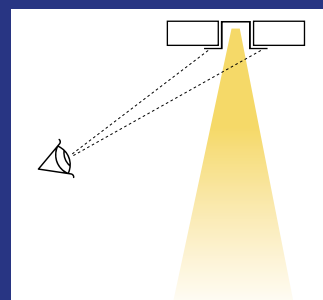

UGR < 19



Hospital

Beam Angle

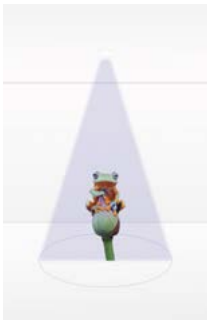

60°



100°

KOBO

incl. DIM 50.000hs L70 / B10 MacAdam 3 IP65 220- 50/ 240V 60Hz 650°C



60°



100°

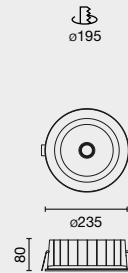

Family	Color T°	Beam Angle	Finish	Control System
0354 Kobo 27W 0355 Kobo 15W	927 2700K CRI90	6 60° 9 100°	1 White	W CASAMBI
	930 3000K CRI90			D DALI
	940 4000K CRI90	ON/OFF		
0354 Kobo 27W	TW 2700-6500K	9 100°	1 White	W CASAMBI D DALI
0354	927	6	1	W

Example **035492761W** — Kobo 27W 2700K CRI90 60° White Casambi

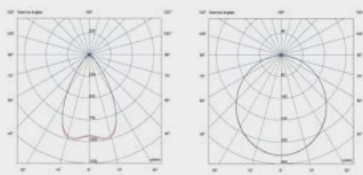

60°

100°

Option	Color T°	CRI	Power	Lumen Output	Beam Angle
927	2700K	90	15W	1506/1661lm	60° / 100°
			27W	2394/2640lm	
930	3000K	90	15W	1551/1711lm	60° / 100°
			27W	2468/2722lm	
940	4000K	90	15W	1598/1762lm	60° / 100°
			27W	2542/2804lm	
TW	2000-6000K	90	27W	1672lm	100°





CROC is a family of recessed light fixtures available in 3 different sizes: 100 mm, 135 mm and 180 mm. Its different colour temperature options and its microprismatic optics for glare control make it a perfect option for work zones and spaces dedicated to healthcare. It has IP44 for humid zones and a low recess height.

CROC es una familia de luminarias empotrables disponible en 3 tamaños diferentes. Sus diferentes opciones de temperatura de color y su óptica micro prismática para el control del deslumbramiento la convierten en una opción perfecta para zonas de trabajo y espacios dedicados a la salud. Presenta índice de protección 44 para zonas húmedas y una baja cota de empotramiento.

CROC



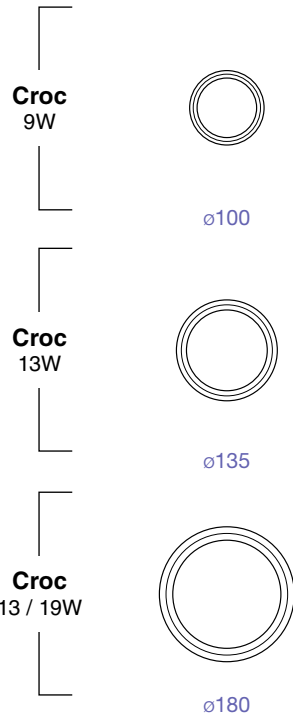

FINISH
Acabado

○ **White**
Blanco

COLOR TEMPERATURE
Temperatura de color

2700K CRI90

3000K CRI90

4000K CRI90

2700-6500K

BEAM ANGLE
Ángulo de apertura

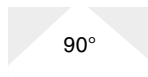

CONTROL SYSTEM
Sistema de control



CASAMBI



Highlights



Different sizes
Diversos tamaños



Tunable White



Micro-prismatic optics
Óptica micro prismática



IP 54/44



Several color temperatures
Varias temperaturas de color



CROC 9W

incl. DIM 50.000hs L70 / B10 MacAdam 3 IP 54/44 220- 50/ 240V 60Hz 650°C

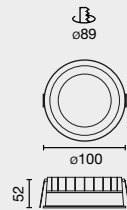

Family	Color T°	Beam Angle	Finish	Control System
43780 Croc 9W	927 2700K CRI90	9 90°	1 White	W CASAMBI
	930 3000K CRI90			D DALI
	940 4000K CRI90			C TRIAC
				ON/OFF

43780 927 9 1 W

Example 4378092791W — Croc 9W 2700K 90° White Casambi

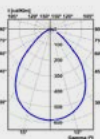

90°

Option	Color T°	CRI	Power	Lumen Output	Beam Angle
927	2700K	90	13W	1009lm	90°
930	3000K	90	13W	1039lm	90°
940	4000K	90	13W	1070lm	90°

CROC 13W

incl. DIM 50.000hs L70 / B10 MacAdam 3 IP 54/44 220- 50/ 240V 60Hz 650°C

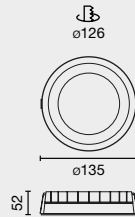

Family	Color T°	Beam Angle	Finish	Control System
43781 Croc 13W	927 2700K CRI90	9 90°	1 White	W CASAMBI
	930 3000K CRI90			D DALI
	940 4000K CRI90			C TRIAC
				ON/OFF

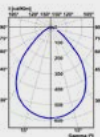

90°

Option	Color T°	CRI	Power	Lumen Output	Beam Angle
927	2700K	90	13W	1409lm	90°
930	3000K	90	13W	1452lm	90°
940	4000K	90	13W	1495lm	90°

CROC 13/19W

incl. DIM 50,000hs L70 / B10 MacAdam 3 IP 54/44 220- 50/ 240V 60Hz 650°C

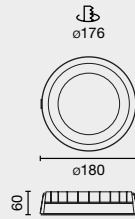

Family	Color T°	Beam Angle	Finish	Control System								
43782 Croc 19W	927 2700K CRI90	9 90°	1 White	<table border="1"> <tr><td>W</td><td>CASAMBI</td></tr> <tr><td>D</td><td>DALI</td></tr> <tr><td>C</td><td>TRIAC</td></tr> <tr><td></td><td>ON/OFF</td></tr> </table>	W	CASAMBI	D	DALI	C	TRIAC		ON/OFF
W	CASAMBI											
D	DALI											
C	TRIAC											
	ON/OFF											
43783 Croc 13W UGR<19	930 3000K CRI90 940 4000K CRI90											
43784 Croc 19W Ø180	TW 2700-6500K	9 90°	1 White	<table border="1"> <tr><td>W</td><td>CASAMBI</td></tr> <tr><td>D</td><td>DALI</td></tr> </table>	W	CASAMBI	D	DALI				
W	CASAMBI											
D	DALI											

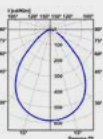

90°

Option	Color T°	CRI	Power	Lumen Output	Beam Angle
927	2700K	90	19W	2681lm	90°
930	3000K	90	19W	2762lm	90°
940	4000K	90	19W	2844lm	90°
TW	2000-6500K	90	19W	1773lm	90°
UGR<19					
927	2700K	90	13W	1616lm	90°
930	3000K	90	13W	1665lm	90°
940	4000K	90	13W	1662lm	90°



Luminaire in a round adjustable format.
This family of luminaires is manufactured in
different sizes and powers so it is easy to find
the one that best suits your lighting needs.

Luminaria de formato redondo orientable.
Esta familia de luminarias se fabrica en
diferentes tamaños y potencias por lo que es
fácil encontrar la que más se ajuste a vuestras
necesidades de iluminación.



OPTIC





Optic Mini
18 / 25W



ø140

Optic
24 / 36W



ø165

FINISH
Acabado

● **Black**
Negro

○ **White**
Blanco

● **Grey**
Gris

COLOR TEMPERATURE
Temperatura de color

2700K CRI82

3000K CRI85

4000K CRI85

2700K CRI95

3000K CRI95

4000K CRI95

MEAT

BREAD

FASHION

BEAM ANGLE
Ángulo de apertura

20°

56°

CONTROL SYSTEM
Sistema de control



CASAMBI



Highlights



Different sizes
Diversos tamaños



Cardanic orientation
Orientación cardánica



High CRI
Alto IRC



Several color temperatures
Varias temperaturas de color

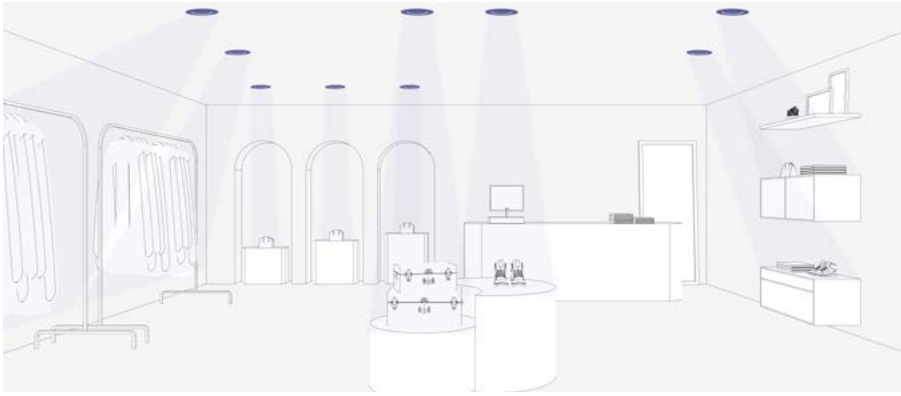

Retail

Beam Angle

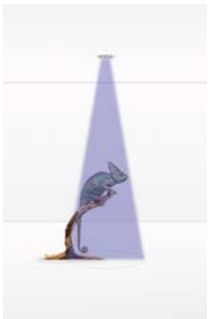

20°

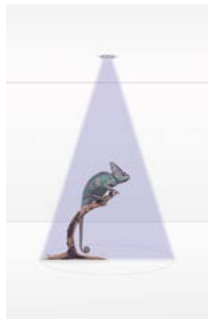

56°

OPTIC MINI

no incl. DIM 20° 50.000hs L80 / B10 MacAdam 3 18W 25W 500mA 33V 700mA 34V 650°C

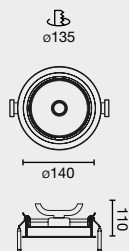

Family	Color T°	Finish
03250 Optic Mini 18 / 25W	300 2700K CRI82 20°	1 White
	310 2700K CRI82 56°	2 Black
	320 3000K CRI85 20°	3 Grey
	330 3000K CRI85 56°	
	340 4000K CRI85 20°	
350 4000K CRI85 56°		
03250 CRI95	360 2700K CRI95 20°	1 White
	370 2700K CRI95 56°	2 Black
	380 3000K CRI95 20°	3 Grey
	390 3000K CRI95 56°	
	400 4000K CRI95 20°	
410 4000K CRI95 56°		
03250 Food	481 BREAD 2500K CRI88 20°	1 White
	491 BREAD 2500K CRI88 56°	2 Black
	501 MEAT CRI82 20°	3 Grey
	511 MEAT CRI82 56°	
03250 Fashion	541 3100K CRI95 20°	1 White
	551 3100K CRI95 56°	2 Black
		3 Grey

03250

300

1

Example **032503001** — Optic Mini 18W 2700K CRI82 20° White

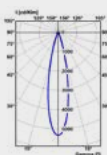

20°

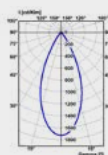

56°

Color T°	CRI	Power	Lumen Output	Beam Angle
2700K	82	18W / 25W	1642lm / 2193lm	20° / 56°
	95		1361lm / 1882lm	
3000K	85	18W / 25W	1693lm / 2261lm	20° / 56°
	95		1403lm / 1878lm	
4000K	85	18W / 25W	1744lm / 2329lm	20° / 56°
	95		1445lm / 1934lm	
MEAT	82	18W / 25W	1335lm	20° / 56°
BREAD 2500K	88	18W / 25W	1801lm	20° / 56°
FASHION 3100K	95	18W / 25W	1841lm	20° / 56°

Driver not included. See recommended drivers on page 490-491
 Driver no incluido. Ver drivers recomendados en página 490-491

OPTIC

no incl. DIM 20° 50.000hs L80 / B10 MacAdam 3 24W 36W 700mA 33V 1050mA 34V 650°C

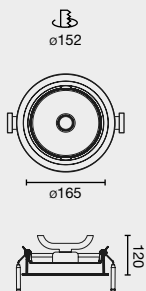

Family	Color T°	Finish
03200 Optic 24 / 36W	300 2700K CRI82 20°	1 White
	310 2700K CRI82 56°	2 Black
	320 3000K CRI85 20°	
	330 3000K CRI85 56°	
	340 4000K CRI85 20°	
	350 4000K CRI85 56°	
03200 CRI95	360 2700K CRI95 20°	1 White
	370 2700K CRI95 56°	2 Black
	380 3000K CRI95 20°	
	390 3000K CRI95 56°	
	400 4000K CRI95 20°	
	410 4000K CRI95 56°	
03200 Food	481 BREAD 2500K CRI88 20°	1 White
	491 BREAD 2500K CRI88 56°	2 Black
	501 MEAT CRI82 20°	
	511 MEAT CRI82 56°	
03200 Fashion	541 3100K CRI95 20°	1 White
	551 3100K CRI95 56°	2 Black

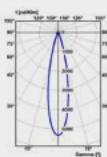

20°

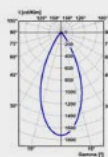

56°

Color T°	CRI	Power	Lumen Output	Beam Angle
2700K	82	24 / 36W	2167lm / 3066lm	20° / 56°
	95		2072lm / 2930lm	
3000K	85	24 / 36W	2234lm / 3161lm	20° / 56°
	95		2136lm / 3021lm	
4000K	85	24 / 36W	2301lm / 3256lm	20° / 56°
	95		2200lm / 3112lm	
MEAT	82	24 / 36W	1406lm / 2023lm	20° / 56°
BREAD 2500K	88	24 / 36W	1912lm / 2750lm	20° / 56°
FASHION 3100K	95	24 / 36W	1977lm / 2844lm	20° / 56°

Driver not included. See recommended drivers on page 490-491
 Driver no incluido. Ver drivers recomendados en página 490-491











Squared luminaire available for 1,2 or 3 lamps. This family of luminaires is manufactured in different sizes and power so it is easy to find one that fits best to your lighting needs.

Colin es una serie de luminarias orientables de formato cuadrado/rectangular disponible para 1, 2 o 3 lámparas. La familia ofrece diferentes opciones de tamaños y potencias por lo que es fácil encontrar la que más se ajuste a vuestras necesidades de iluminación.



COLIN

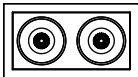
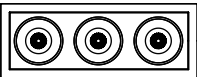

	TRIM Con marco			TRIMLESS Sin marco	
Colin Nano 7 / 13W					
	113x113	113x223		100x100	100x210
Colin Mini 18 / 25W					
	140x140	140x295	140x435		
Colin 24 / 36W					
	173x173	173x343	173x512		

FINISH
Acabado

● **Black**
Negro

○ **White**
Blanco

● **Grey**
Gris

COLOR TEMPERATURE
Temperatura de color

2700K CRI82	3000K CRI85	4000K CRI85
2700K CRI95	3000K CRI95	4000K CRI95
MEAT	BREAD	FASHION

BEAM ANGLE
Ángulo de apertura



CONTROL SYSTEM
Sistema de control



CASAMBI



Highlights



Different sizes
Diversos tamaños



Cardanic orientation
Orientación cardánica



High CRI
Alto IRC



Several color temperatures
Varias temperaturas de color

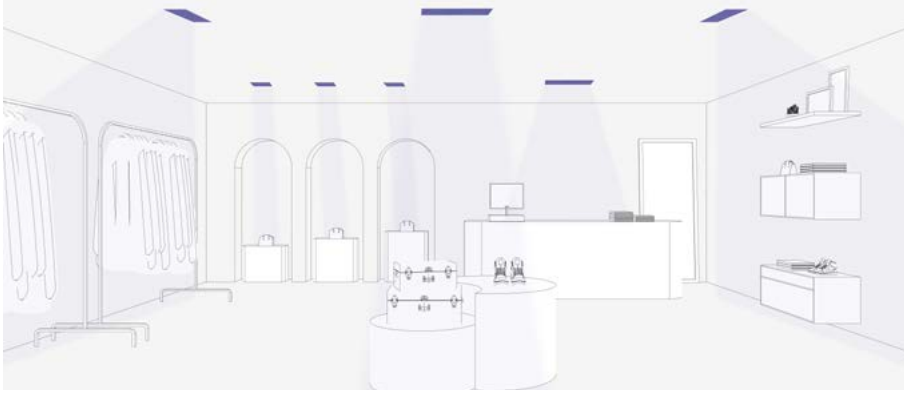

Retail

Beam Angle

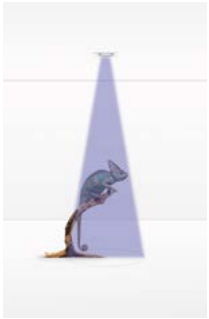

20°

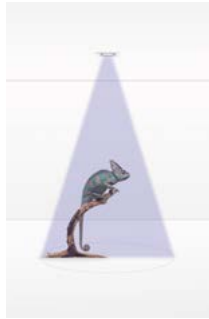

56°

COLIN NANO 1L

no incl. DIM 20° 50.000hs L80 / B10 MacAdam 3 7W 13W 200mA 34V 350mA 35V 650°C

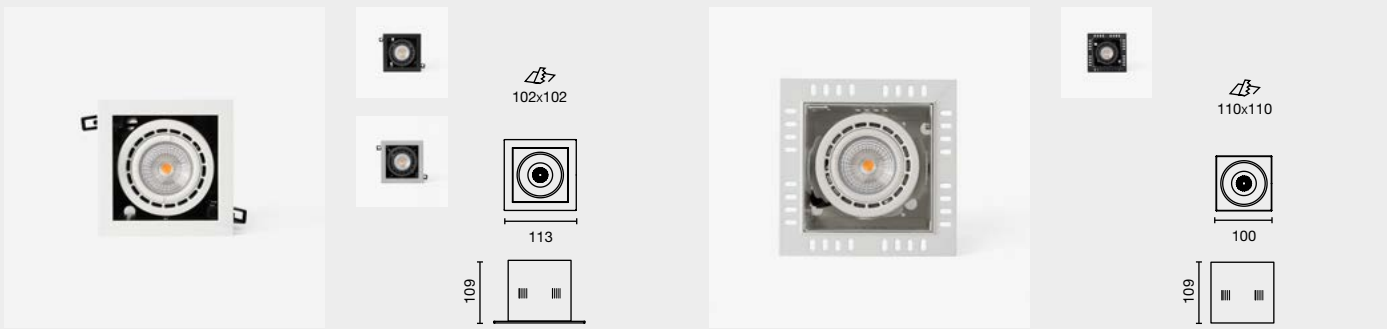

Family

035000	Colin Nano 7 / 13W
035100	Colin Nano Trimless 7 / 13W

Color T°

10	2700K CRI82 20°
20	2700K CRI82 56°
30	3000K CRI85 20°
40	3000K CRI85 56°
50	4000K CRI85 20°
60	4000K CRI85 56°

Finish

1	White
2	Black
3	Grey (available only for trim)

035000

10

1

Example **035000101** — Colin Nano 7W 2700K CRI82 20° White

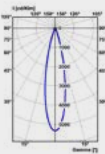

20°

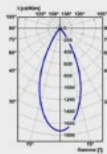

56°

Color T°	CRI	Power	Lumen Output	Beam Angle
2700K	82	7W / 13W	691lm / 1120lm	20° / 56°
3000K	85	7W / 13W	712lm / 1155lm	20° / 56°
4000K	85	7W / 13W	733lm / 1190lm	20° / 56°

Driver not included. See recommended drivers on page 490-491
Driver no incluido. Ver drivers recomendados en página 490-491

COLIN NANO 2L

no incl. DIM 20° 50.000hs L80 / B10 MacAdam 3 2x7W 200mA 34V 2x13W 350mA 35V 650°C

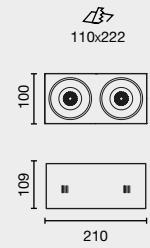
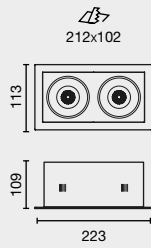

Family

035005	Colin Nano 2L 14 / 26W
035105	Colin Nano 2L Trimless 14 / 26W

Color T°

00	2700K CRI82 20°
10	2700K CRI82 56°
20	3000K CRI85 20°
30	3000K CRI85 56°
40	4000K CRI85 20°
50	4000K CRI85 56°

Finish

1	White
2	Black
3	Grey (available only for trim)

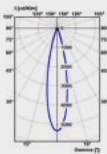

20°

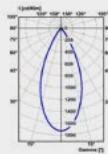

56°

Color T°	CRI	Power	Lumen Output	Beam Angle
2700K	82	2x7W / 2x13W	2x691lm / 2x1120lm	20° / 56°
3000K	85	2x7W / 2x13W	2x712lm / 2x1155lm	20° / 56°
4000K	85	2x7W / 2x13W	2x733lm / 2x1190lm	20° / 56°

Driver not included. See recommended drivers on page 490-491
Driver no incluido. Ver drivers recomendados en página 490-491

COLIN MINI 1L

no incl. DIM 20° 50.000hs L80 / B10 MacAdam 3 18W 25W 500mA 33V 700mA 34V 650°C

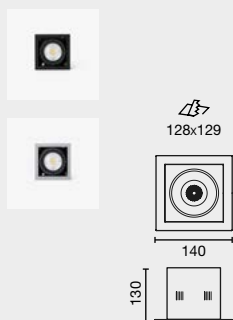

Family	Color T°	Finish
033008 Colin Mini 18 / 25W	30 2700K CRI82 20°	1 White
	40 2700K CRI82 56°	2 Black
	50 3000K CRI85 20°	3 Grey
	60 3000K CRI85 56°	
	70 4000K CRI85 20°	
	80 4000K CRI85 56°	
03300 CRI95	890 2700K CRI95 20°	1 White
	900 2700K CRI95 56°	2 Black
	910 3000K CRI95 20°	3 Grey
	920 3000K CRI95 56°	
	930 4000K CRI95 20°	
	940 4000K CRI95 56°	
03301 Food	011 BREAD 2500K CRI88 20°	1 White
	021 BREAD 2500K CRI88 56°	2 Black
	031 MEAT CRI82 20°	3 Grey
	041 MEAT CRI82 56°	
03301 Fashion	050 3100K CRI95 20°	1 White
	060 3100K CRI95 56°	2 Black
		3 Grey

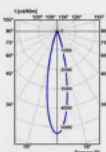

20°

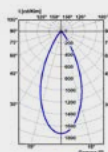

56°

Color T°	CRI	Power	Lumen Output	Beam Angle
2700K	82	18W / 25W	1642lm / 2193lm	20° / 56°
	95		1361lm / 1882lm	
3000K	85	18W / 25W	1693lm / 2261lm	20° / 56°
	95		1403lm / 1878lm	
4000K	85	18W / 25W	1744lm / 2329lm	20° / 56°
	95		1445lm / 1934lm	
MEAT	82	18W / 25W	1335lm	20° / 56°
BREAD 2500K	88	18W / 25W	1801lm	20° / 56°
FASHION 3100K	95	18W / 25W	1841lm	20° / 56°

Driver not included. See recommended drivers on page 490-491
 Driver no incluido. Ver drivers recomendados en página 490-491

COLIN MINI 2L

no incl. DIM 20° 50.000hs L80 / B10 MacAdam 3 2x18W 500mA 33V 2x25W 700mA 34V 650°C

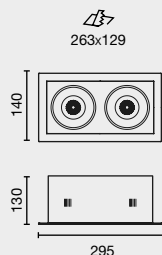

Family	Color T°	Finish
03301 Colin Mini 2L 36 / 50W	090 2700K CRI82 20°	1 White
	100 2700K CRI82 56°	2 Black
	110 3000K CRI85 20°	3 Grey
	120 3000K CRI85 56°	
	130 4000K CRI85 20°	
140 4000K CRI85 56°		
03301 CRI95	150 2700K CRI95 20°	1 White
	160 2700K CRI95 56°	2 Black
	170 3000K CRI95 20°	3 Grey
	180 3000K CRI95 56°	
	190 4000K CRI95 20°	
200 4000K CRI95 56°		
03301 Food	271 BREAD 2500K CRI88 20°	1 White
	281 BREAD 2500K CRI88 56°	2 Black
	291 MEAT CRI82 20°	3 Grey
	301 MEAT CRI82 56°	
03301 Fashion	330 3100K CRI95 20°	1 White
	340 3100K CRI95 56°	2 Black
		3 Grey

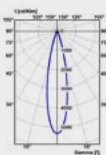

20°

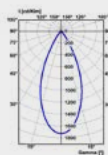

56°

Color T°	CRI	Power	Lumen Output	Beam Angle
2700K	82	2x18W / 2x25W	2x1642lm / 2x2193lm	20° / 56°
	95		2x1361lm / 2x1882lm	
3000K	82	2x18W / 2x25W	2x1693lm / 2x2261lm	20° / 56°
	95		2x1403lm / 2x1878lm	
4000K	82	2x18W / 2x25W	2x1744lm / 2x2329lm	20° / 56°
	95		2x1445lm / 2x1934lm	
MEAT	82	2x18W / 2x25W	2x1335lm	20° / 56°
BREAD 2500K	88	2x18W / 2x25W	2x1801lm	20° / 56°
FASHION 3100K	95	2x18W / 2x25W	2x1841lm	20° / 56°

Driver not included. See recommended drivers on page 490-491
 Driver no incluido. Ver drivers recomendados en página 490-491

COLIN MINI 3L

no incl. DIM 20° 50.000hs L80 / B10 MacAdam 3 3x18W 3x25W 500mA 33V 700mA 34V 650°C



Family	Color T°	Finish
03301 Colin Mini 3L 54 / 75W	350 2700K CRI82 20°	1 White
	360 2700K CRI82 56°	2 Black
	370 3000K CRI85 20°	3 Grey
	380 3000K CRI85 56°	
	390 4000K CRI85 20°	
400 4000K CRI85 56°		
03301 CRI95	410 2700K CRI95 20°	1 White
	420 2700K CRI95 56°	2 Black
	430 3000K CRI95 20°	3 Grey
	440 3000K CRI95 56°	
	450 4000K CRI95 20°	
460 4000K CRI95 56°		
03301 Food	531 BREAD 2500K CRI88 20°	1 White
	541 BREAD 2500K CRI88 56°	2 Black
	551 MEAT CRI82 20°	3 Grey
	561 MEAT CRI82 56°	
03301 Fashion	590 3100K CRI95 20°	1 White
	600 3100K CRI95 56°	2 Black
		3 Grey

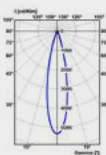

20°

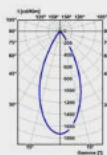

56°

Color T°	CRI	Power	Lumen Output	Beam Angle
2700K	82	3x18W / 3x25W	3x1642lm / 3x2193lm	20° / 56°
	95		3x1361lm / 3x1882lm	
3000K	82	3x18W / 3x25W	3x1693lm / 3x2261lm	20° / 56°
	95		3x1403lm / 3x1878lm	
4000K	82	3x18W / 3x25W	3x1744lm / 3x2329lm	20° / 56°
	95		3x1445lm / 3x1934lm	
MEAT	82	3x18W / 3x25W	3x1335lm	20° / 56°
BREAD 2500K	88	3x18W / 3x25W	3x1801lm	20° / 56°
FASHION 3100K	95	3x18W / 3x25W	3x1841lm	20° / 56°

Driver not included. See recommended drivers on page 490-491
 Driver no incluido. Ver drivers recomendados en página 490-491

COLIN 1L

no incl. DIM 20° 50.000hs L80 / B10 MacAdam 3 24W 36W 700mA 33V 1050mA 34V 650°C

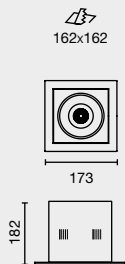
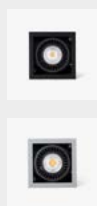

Family	Color T°	Finish
03400 Colin 24 / 36W	850 2700K CRI82 20°	1 White
	860 2700K CRI82 56°	2 Black
	870 3000K CRI85 20°	3 Grey
	880 3000K CRI85 56°	
	890 4000K CRI85 20°	
900 4000K CRI85 56°		
03400 CRI95	910 2700K CRI95 20°	1 White
	920 2700K CRI95 56°	2 Black
	930 3000K CRI95 20°	3 Grey
	940 3000K CRI95 56°	
	950 4000K CRI95 20°	
960 4000K CRI95 56°		
03401 Food	031 BREAD 2500K CRI88 20°	1 White
	041 BREAD 2500K CRI88 56°	2 Black
	051 MEAT CRI82 20°	3 Grey
	061 MEAT CRI82 56°	
03401 Fashion	090 3100K CRI95 20°	1 White
	100 3100K CRI95 56°	2 Black
3 Grey		
0340040 Colin QR-111 LED G53 12V max.12W		1 White
		2 Black
		3 Grey

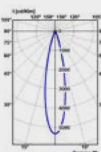

20°

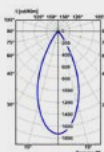

56°

Color T°	CRI	Power	Lumen Output	Beam Angle
2700K	82	24 / 36W	2167lm / 3066lm	20° / 56°
	95		2072lm / 2930lm	
3000K	85	24 / 36W	2234lm / 3161lm	20° / 56°
	95		2136lm / 3021lm	
4000K	85	24 / 36W	2301lm / 3256lm	20° / 56°
	95		2200lm / 3112lm	
MEAT	82	24 / 36W	1406lm / 2023lm	20° / 56°
BREAD 2500K	88	24 / 36W	1912lm / 2750lm	20° / 56°
FASHION 3100K	95	24 / 36W	1977lm / 2844lm	20° / 56°

Driver not included. See recommended drivers on page 490-491
 Driver no incluido. Ver drivers recomendados en página 490-491



Family	Color T°	Finish
03401 Colin 3L 48 / 72W	110 2700K CRI82 20°	1 White
	120 2700K CRI82 56°	2 Black
	130 3000K CRI85 20°	3 Grey
	140 3000K CRI85 56°	
	150 4000K CRI85 20°	
	160 4000K CRI85 56°	
03401 CRI95	170 2700K CRI95 20°	1 White
	180 2700K CRI95 56°	2 Black
	190 3000K CRI95 20°	3 Grey
	200 3000K CRI95 56°	
	210 4000K CRI95 20°	
	220 4000K CRI95 56°	
03401 Food	291 BREAD 2500K CRI88 20°	1 White
	301 BREAD 2500K CRI88 56°	2 Black
	311 MEAT CRI82 20°	3 Grey
	321 MEAT CRI82 56°	
03401 Fashion	350 3100K CRI95 20°	1 White
	360 3100K CRI95 56°	2 Black
		3 Grey
0340050 Colin 2L QR-111 LED G53 12V max.12W		1 White
		2 Black
		3 Grey

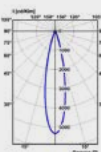

20°

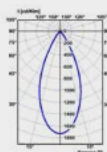

56°

Color T°	CRI	Power	Lumen Output	Beam Angle
2700K	82	2x24 / 2x36W	2x2167lm / 2x3066lm	20° / 56°
	95		2x2072lm / 2x2930lm	
3000K	85	2x24 / 2x36W	2x2234lm / 2x3161lm	20° / 56°
	95		2x2136lm / 2x3021lm	
4000K	85	2x24 / 2x36W	2x2301lm / 2x3256lm	20° / 56°
	95		2x2200lm / 2x3112lm	
MEAT	82	2x24 / 2x36W	2x1406lm / 2x2023lm	20° / 56°
BREAD 2500K	88	2x24 / 2x36W	2x1912lm / 2x2750lm	20° / 56°
FASHION 3100K	95	2x24 / 2x36W	2x1977lm / 2x2844lm	20° / 56°

Driver not included. See recommended drivers on page 490-491
 Driver no incluido. Ver drivers recomendados en página 490-491

COLIN 3L

no incl. DIM 20° 50.000hs L80 / B10 MacAdam 3 3x24W 3x36W 700mA 33V 1050mA 34V 650°C



Family	Color T°	Finish	
03401 Colin 3L 72 / 108W	370 2700K CRI82 20°	1 White	
	380 2700K CRI82 56°	2 Black	
	390 3000K CRI85 20°	3 Grey	
	400 3000K CRI85 56°		
	410 4000K CRI85 20°		
	420 4000K CRI85 56°		
	03401 CRI95	430 2700K CRI95 20°	1 White
		440 2700K CRI95 56°	2 Black
		450 3000K CRI95 20°	3 Grey
		460 3000K CRI95 56°	
470 4000K CRI95 20°			
480 4000K CRI95 56°			
03401 Food	551 BREAD 2500K CRI88 20°	1 White	
	561 BREAD 2500K CRI88 56°	2 Black	
	571 MEAT CRI82 20°	3 Grey	
	581 MEAT CRI82 56°		
03401 Fashion	610 3100K CRI95 20°	1 White	
	620 3100K CRI95 56°	2 Black	
		3 Grey	
0340060 Colin 3L QR-111 LED G53 12V max.12W		1 White	
		2 Black	
		3 Grey	

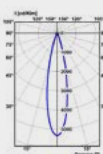

20°

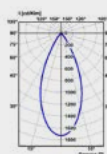

56°

Color T°	CRI	Power	Lumen Output	Beam Angle
2700K	82	3x24 / 3x36W	3x2167lm / 3x3066lm	20° / 56°
	95		3x2072lm / 3x2930lm	
3000K	85	3x24 / 3x36W	3x2234lm / 3x3161lm	20° / 56°
	95		3x2136lm / 3x3021lm	
4000K	85	3x24 / 3x36W	3x2301lm / 3x3256lm	20° / 56°
	95		3x2200lm / 3x3112lm	
MEAT	82	3x24 / 3x36W	3x1406lm / 3x2023lm	20° / 56°
BREAD 2500K	88	3x24 / 3x36W	3x1912lm / 3x2750lm	20° / 56°
FASHION 3100K	95	3x24 / 3x36W	3x1977lm / 3x2844lm	20° / 56°

Driver not included. See recommended drivers on page 490-491
 Driver no incluido. Ver drivers recomendados en página 490-491



FOST

RECESSED

Recessed projector with an optical block designed to meet the highest requirements of accent lighting. This product offers an elegant and efficient solution to highlight specific spaces, providing exceptional quality accent lighting. Its recessed design makes it ideal for discreet integration into various environments, ensuring optimal performance in creating accentuated lighting effects.

Proyector empotrable con un bloque óptico diseñado para satisfacer las más altas exigencias de iluminación de acento. Este producto ofrece una solución elegante y eficiente para resaltar espacios específicos, proporcionando una iluminación de calidad excepcional. Su diseño empotrable lo hace ideal para integrarse de manera discreta en diversos entornos, garantizando un rendimiento óptimo en la creación de efectos de iluminación acentuada.



FOST Collection



Track
39



Pulldown
237



Ceiling
331



Surface
321



Pendant
379

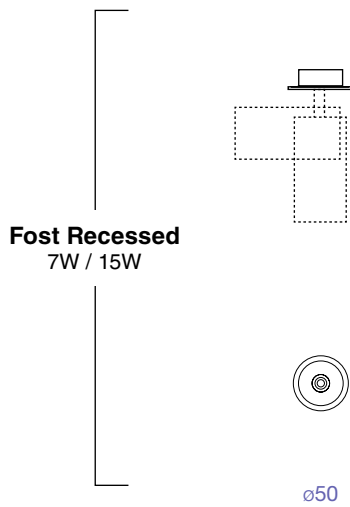

FINISH
Acabado

● **Black**
Negro

○ **White**
Blanco

COLOR TEMPERATURE
Temperatura de color

2700K CRI90	3000K CRI90	4000K CRI90
2700K CRI97	3000K CRI97	4000K CRI97

BEAM ANGLE
Ángulo de apertura



ACCESSORIES
Accesorios

○
White Ring

○
Copper Ring

CONTROL SYSTEM
Sistema de control



Highlights



Anti-glare
Anti deslumbramiento



High CRI
Alto IRC



Several color temperatures
Varias temperaturas de color





White Ring



Copper Ring

Accessories

	White Ring	Copper Ring
ø50	011600099	011600098

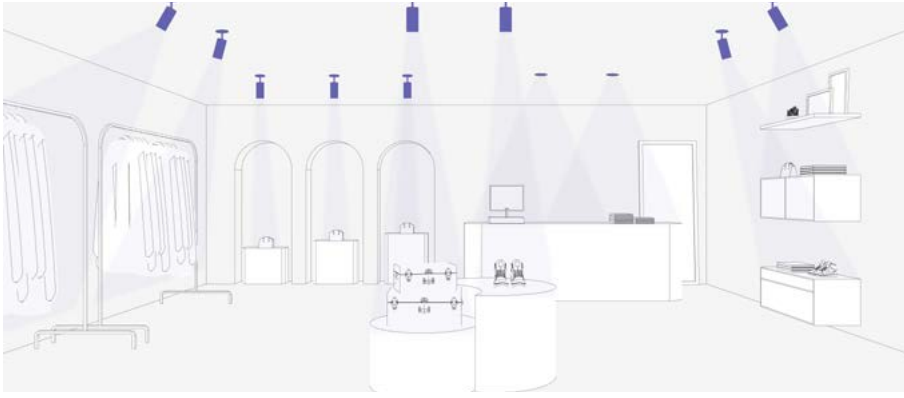

Retail



Restaurant

Beam Angle



12°

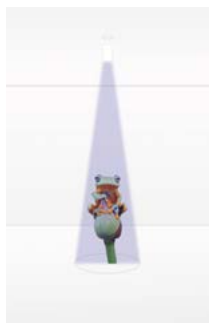

20°

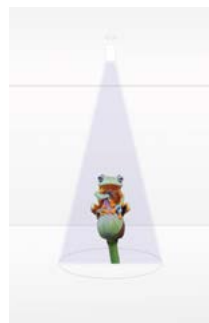

35°

FOST RECESSED

incl. DIM 355° 90° 50.000hs L70 / B10 MacAdam 2&3 220-240V 50 / 60Hz 650°C

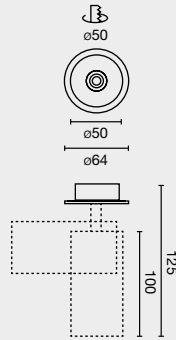

Family	Color T°	Beam Angle	Finish	Control System
0124 Fost Recessed 7W	927 2700K CRI90	1 12°	1 White	D DALI ON/OFF
	930 3000K CRI90	2 20°	2 Black	
	940 4000K CRI90	3 35°		
	X24 2700K CRI97			
	X30 3000K CRI97			
	X40 4000K CRI97			

0125 Fost Recessed 15W	927 2700K CRI90	1 12°	1 White	W CASAMBI ON/OFF
	930 3000K CRI90	2 20°	2 Black	
	940 4000K CRI90	3 35°		
	X24 2700K CRI97			
	X30 3000K CRI97			
	X40 4000K CRI97			

0125 927 1 1 1 W

Example 012592711W — Fost Recessed 15W 2700K CRI90 12° White Casambi

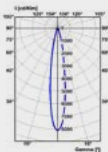

12°

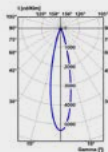

20°

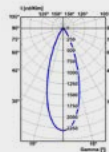

35°

Option	Color T°	CRI	Power	Lumen Output	Beam Angle
927	2700K	90	7W	663lm / 674lm / 699lm	12° / 20° / 35°
x24		97	7W	596lm / 607lm / 629lm	12° / 20° / 35°
930		3000K	90	7W	683lm / 695lm / 721lm
x30	97		7W	615lm / 626lm / 649lm	12° / 20° / 35°
940	4000K		90	7W	704lm / 716lm / 742lm
x40		97	7W	633lm / 644lm / 668lm	12° / 20° / 35°
927		2700K	90	15W	1235lm / 1257lm / 1303lm
X24	97		15W	1111lm / 1131lm / 1172lm	12° / 20° / 35°
930	3000K		90	15W	1273lm / 1295lm / 1343lm
X30		97	15W	1146lm / 1166lm / 1209lm	12° / 20° / 35°
940		4000K	90	15W	1311lm / 1334lm / 1383lm
X40	97		15W	1180lm / 1201lm / 1245lm	12° / 20° / 35°







FOST

PULLDOWN

Recessed light fixture designed to fulfill the downlight function with the possibility to be converted into a 100% functional projector thanks to its optical block extraction system, enabling it to meet the highest requirements of accent lighting. This characteristic grants FOST PULLDOWN a flexibility suitable for any multifunctional spaces that require its adaptation or modification from a fixed point.

Luminaria empotrada diseñada para cumplir la función de downlight y con posibilidad de convertirse en un proyector 100% funcional, gracias a su sistema de extracción del bloque óptico que le permite cumplir las máximas exigencias de una iluminación de acento. Esta característica le otorga a FOST PULLDOWN una flexibilidad idónea para espacios multifuncionales, que requieran una adaptación o modificación de éste desde un punto fijo.



FOST Collection



Track
39



Recessed
227



Ceiling
331



Surface
321



Pendant
379

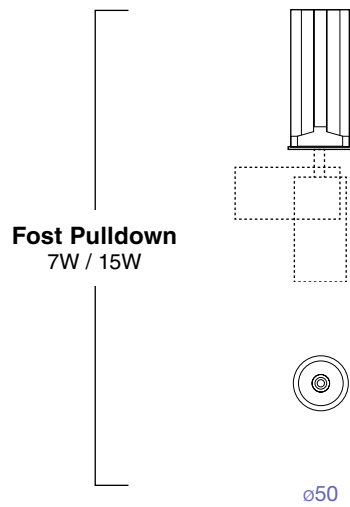

FINISH
Acabado

● **Black**
Negro

○ **White**
Blanco

COLOR TEMPERATURE
Temperatura de color

2700K CRI90	3000K CRI90	4000K CRI90
2700K CRI97	3000K CRI97	4000K CRI97

BEAM ANGLE
Ángulo de apertura



ACCESSORIES
Accesorios

○
White Ring

○
Copper Ring

CONTROL SYSTEM
Sistema de control



CASAMBI

Highlights



Its extraction system enables the block to be positioned at different heights without limiting creativity, creating a decorative geometric effect while lighting the space.

Su sistema de extracción permite posicionar el bloque a diferentes alturas sin límites para la creatividad y generando un efecto geométrico decorativo a la vez que ilumina el espacio.

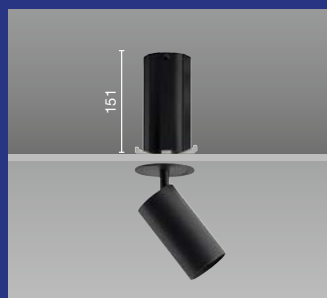

Consider the installation height in your project
Tenga en cuenta la altura de la instalación en su proyecto



High CRI
Alto IRC



Several color temperatures
Varias temperaturas de color





White Ring



Copper Ring

Accessories

	White Ring	Copper Ring
ø50	011600099	011600098

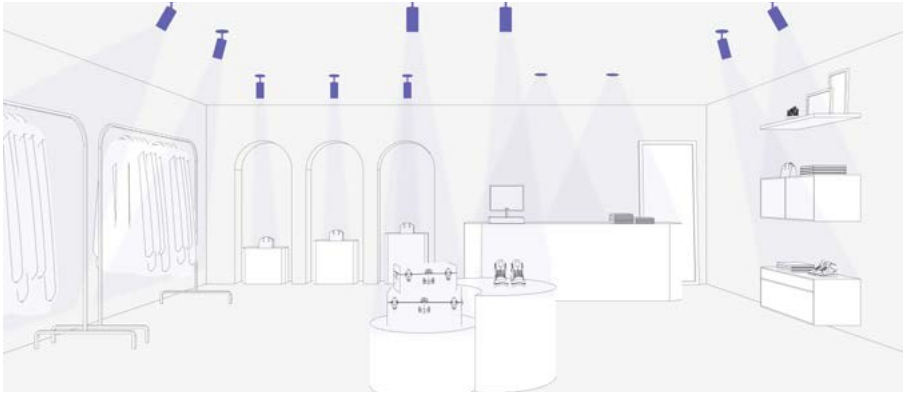

Retail



Restaurant

Beam Angle



12°

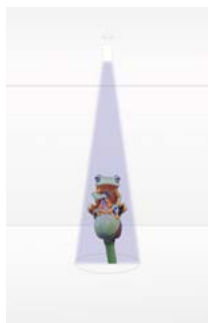

20°

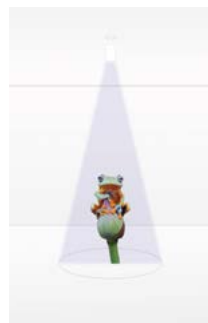

35°

FOST PULLDOWN

incl. DIM 355° 90° 50.000hs L70 / B10 MacAdam 2&3 220-240V 50 / 60Hz 650°C

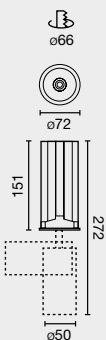

Family	Color T°	Beam Angle	Finish	Control System
0123 Fost Pulldown 7W	927 2700K CRI90	1 12°	1 White	D DALI ON/OFF
	930 3000K CRI90	2 20°	2 Black	
	940 4000K CRI90	3 35°		
	X27 2700K CRI97			
	X30 3000K CRI97			
	X40 4000K CRI97			

0122 Fost Pulldown 15W	927 2700K CRI90	1 12°	1 White	W CASAMBI ON/OFF
	930 3000K CRI90	2 20°	2 Black	D DALI ON/OFF
	940 4000K CRI90	3 35°		
	X27 2700K CRI97			
	X30 3000K CRI97			
	X40 4000K CRI97			

0122 927 1 1 W

Example 012292711W — Fost Pulldown 15W 2700K CRI90 12° White Casambi

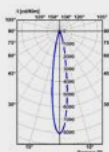

12°

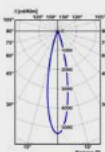

20°

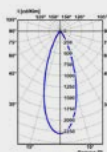

35°

Option	Color T°	CRI	Power	Lumen Output	Beam Angle
927	2700K	90	7W	663lm / 674lm / 699lm	15°/25°/35°
x24		97	7W	596lm / 607lm / 629lm	15°/25°/35°
930	3000K	90	7W	683lm / 695lm / 721lm	15°/25°/35°
x30		97	7W	615lm / 626lm / 649lm	15°/25°/35°
940	4000K	90	7W	704lm / 716lm / 742lm	15°/25°/35°
x40		97	7W	633lm / 644lm / 668lm	15°/25°/35°
927	2700K	90	15W	1235lm / 1257lm / 1303lm	12° / 20° / 35°
X24		97	15W	1111lm / 1131lm / 1172lm	12° / 20° / 35°
930	3000K	90	15W	1273lm / 1295lm / 1343lm	12° / 20° / 35°
X30		97	15W	1146lm / 1166lm / 1209lm	12° / 20° / 35°
940	4000K	90	15W	1311lm / 1334lm / 1383lm	12° / 20° / 35°
X40		97	15W	1180lm / 1201lm / 1245lm	12° / 20° / 35°





TEIDE

TEIDE is a modular system of recessed light fixtures which stands out for its great versatility, high visual comfort and the orientability of its modules. Minimalist in design, it offers a broad integration with architecture, ideal for residential and retail use. Committed to lighting excellence with CRI97 and 2 MacAdam options.

TEIDE es un sistema modular de luminarias de empotrar que destaca por su gran versatilidad, alto confort visual y la orientabilidad de sus módulos. De diseño minimalista, ofrece una amplia integración con la arquitectura, ideal para uso residencial y retail. Apuesta por la excelencia lumínica con las opciones IRC97 y 2 MacAdam.



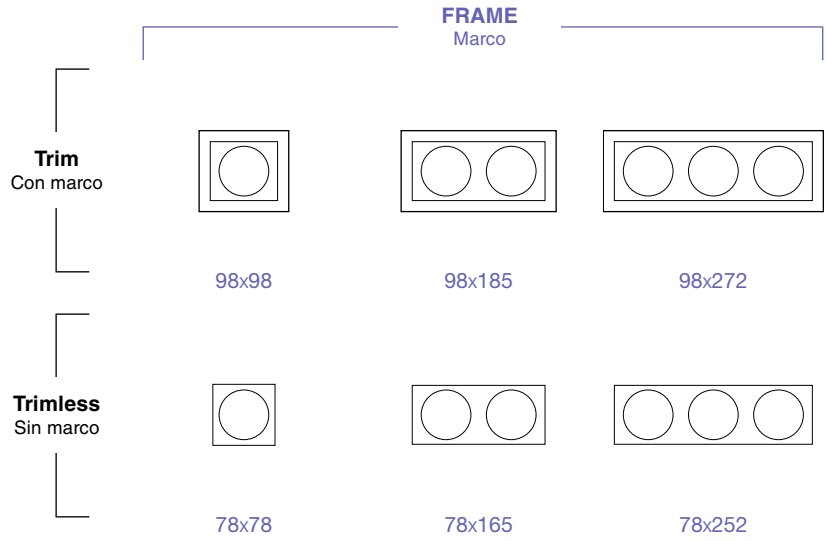
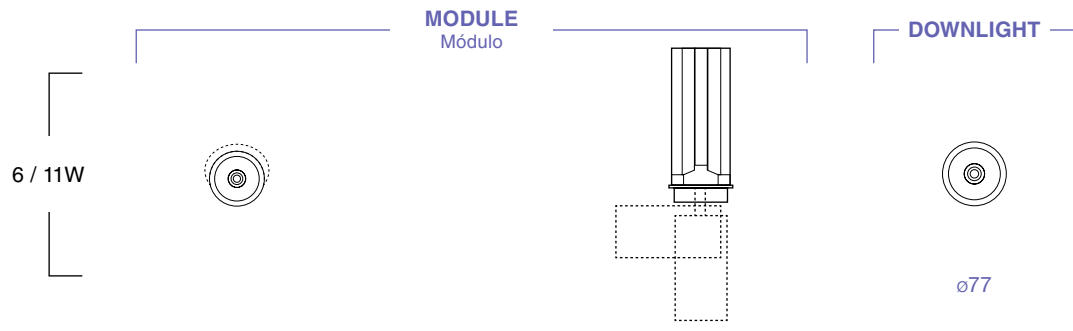

FINISH
Acabado

- **Black**
Negro
- **White**
Blanco

COLOR TEMPERATURE
Temperatura de color

- | | |
|--------------------|--------------------|
| 2700K CRI90 | 3000K CRI90 |
| 2700K CRI97 | 3000K CRI97 |

BEAM ANGLE
Ángulo de apertura

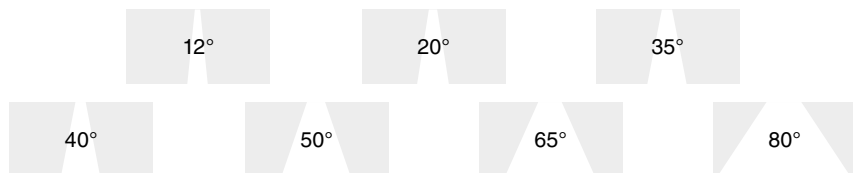

CONTROL SYSTEM
Sistema de control



Highlights

Teide system



Module Downlight



Projector



Trim 1L



Trim 2L



Trim 3L



Trimless 1L



Trimless 2L



Trimless 3L

The system consists of a round downlight module and a spotlight module that can be combined in square/rectangular recessed frames with 1, 2 and 3 lights (also available in frameless version). The downlight module is also available in a round hole installation version, TEIDE Downlight.

El sistema se compone de un módulo redondo tipo downlight y de otro tipo proyector que se pueden combinar entre sí en marcos de empotrar cuadrados/rectangulares de 1, 2 y 3 luces (también disponibles en versión sin marco). El módulo tipo downlight está además disponible en su versión de instalación para agujero redondo, TEIDE Downlight.



Pulldown projector module
Módulo proyector extraíble

Teide downlight



Orientation without light loss
Orientación sin pérdida de luz



86x86

Trim 1L

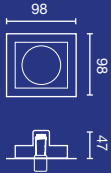

86x175

Trim 2L

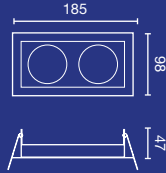

86x262

Trim 3L

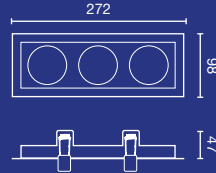

80x80

Trimless 1L

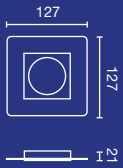

80x175

Trimless 2L

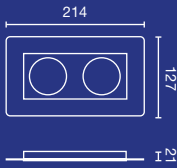

80x262

Trimless 3L

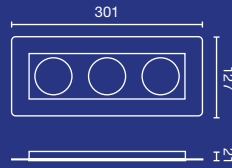

Frames

Trim 1L	Trim 2L	Trim 3L	Trimless 1L	Trimless 2L	Trimless 3L
● 034600011	● 034600021	● 034600031	● 034700011	● 034700021	● 034700031
● 034600012	● 034600022	● 034600032	● 034700012	● 034700022	● 034700032

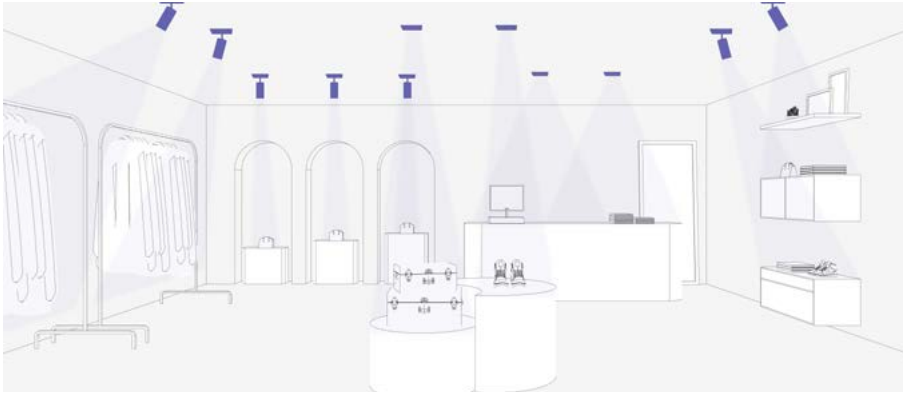

Retail



Restaurant

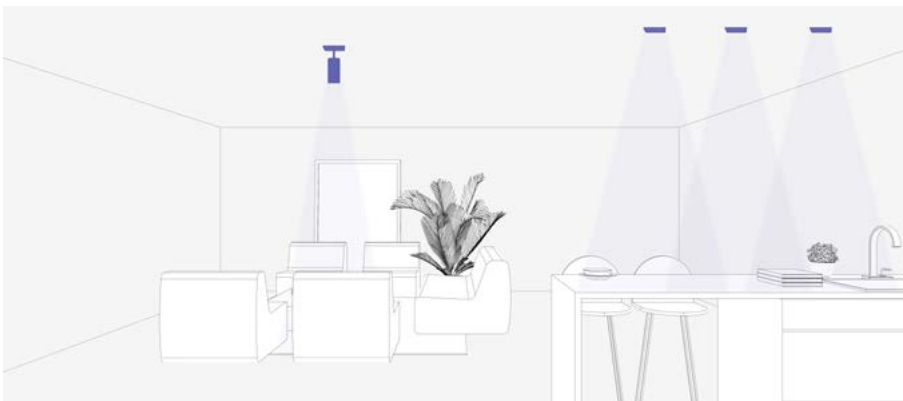

Residential

Beam Angle Downlight

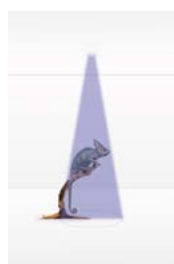

40°

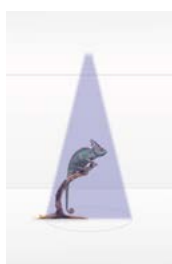

50°

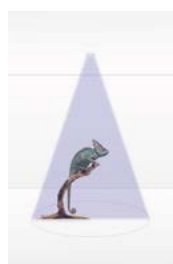

65°

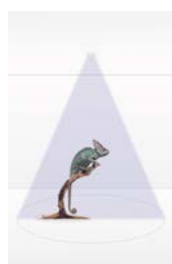

80°



12°



20°



35°

Beam Angle Projector

TEIDE PROJECTOR MODULE

incl. DIM 355° 80° 50.000hs L70 / B10 MacAdam 2&3 220-240V 50 / 60Hz 650°C

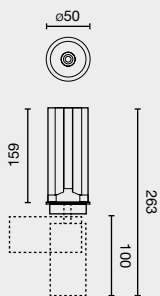

Family	Color T°	Beam Angle	Finish	Control System
0349 Teide Projector Module 9W	927 2700K CRI90	1 12° 2 20° 3 35°	1 White	D ON/OFF
	930 3000K CRI90		2 Black	
	X27 2700K CRI97			
	X30 3000K CRI97			

0349 927 1 1 W

Example 034992711D — Teide Projector Module 9W 2700K CRI90 12° White Dali

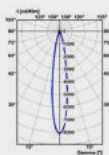

12°

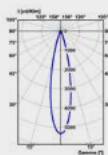

20°

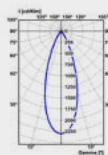

35°

Option	Color T°	CRI	Power	Lumen Output	Beam Angle
927	2700K	90	9W	741lm / 754lm / 782lm	12° / 20° / 35°
X27		97	9W	667lm / 678lm / 703lm	12° / 20° / 35°
930	3000K	90	9W	764lm / 777lm / 806lm	12° / 20° / 35°
X30		97	9W	687lm / 699lm / 725lm	12° / 20° / 35°

See frame options on page 252
Ver opciones de marco en página 252



TEIDE DOWNLIGHT MODULE

incl. DIM 355° 45° 50.000hs L70 / B10 MacAdam 2&3 220-240V 50 / 60Hz 650°C

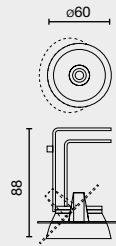

Family	Color T°	Beam Angle	Finish	Control System
0352 Teide Downlight Module 10W	927 2700K CRI90	4 40°	1 White	D ON/OFF
	930 3000K CRI90	5 50°	2 Black	
	X27 2700K CRI97	6 65°		
	X30 3000K CRI97	8 80°		

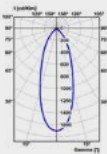

40°

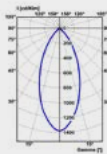

50°

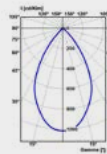

65°

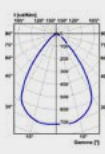

80°

Option	Color T°	CRI	Power	Lumen Output	Beam Angle
927	2700K	90	10W	774lm / 769lm / 783lm / 812lm	40° / 50° / 65° / 80°
X27		97	10W	697lm / 692lm / 704lm / 731lm	40° / 50° / 65° / 80°
930	3000K	90	10W	798lm / 793lm / 807lm / 837lm	40° / 50° / 65° / 80°
X30		97	10W	718lm / 714lm / 726lm / 753lm	40° / 50° / 65° / 80°

See frame options on page 252
Ver opciones de marco en página 252

TEIDE DOWNLIGHT

incl. DIM 355° 45° 50.000hs L70 / B10 MacAdam 2&3 220-240V 50 / 60Hz 650°C

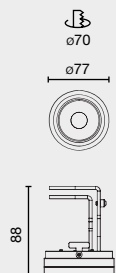

Family	Color T°	Beam Angle	Finish	Control System
0348 Teide Downlight 10W	927 2700K CRI90	4 40°	1 White	D ON/OFF
	930 3000K CRI90	5 50°	2 Black	
	X27 2700K CRI97	6 65°		
	X30 3000K CRI97	8 80°		

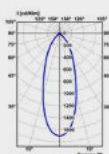

40°

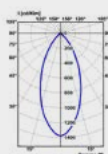

50°

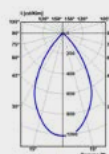

65°

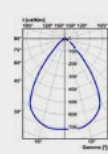

80°

Option	Color T°	CRI	Power	Lumen Output	Beam Angle
927	2700K	90	10W	774lm / 769lm / 783lm / 812lm	40° / 50° / 65° / 80°
X27		97	10W	697lm / 692lm / 704lm / 731lm	40° / 50° / 65° / 80°
930	3000K	90	10W	798lm / 793lm / 807lm / 837lm	40° / 50° / 65° / 80°
X30		97	10W	718lm / 714lm / 726lm / 753lm	40° / 50° / 65° / 80°

See frame options on page 252
Ver opciones de marco en página 252



PODIUM is a modular system of recessed and surface light fixtures which offers different light effects and configurations, enabling the creation of different climates with an integrated aesthetic. One product, one project, infinite possibilities.

PODIUM es un sistema modular de luminarias de empotrar y de superficie que ofrece diferentes efectos lumínicos y configuraciones permitiendo generar diversos climas con una estética integrada. Un producto, un proyecto, infinitas posibilidades.

PODIUM

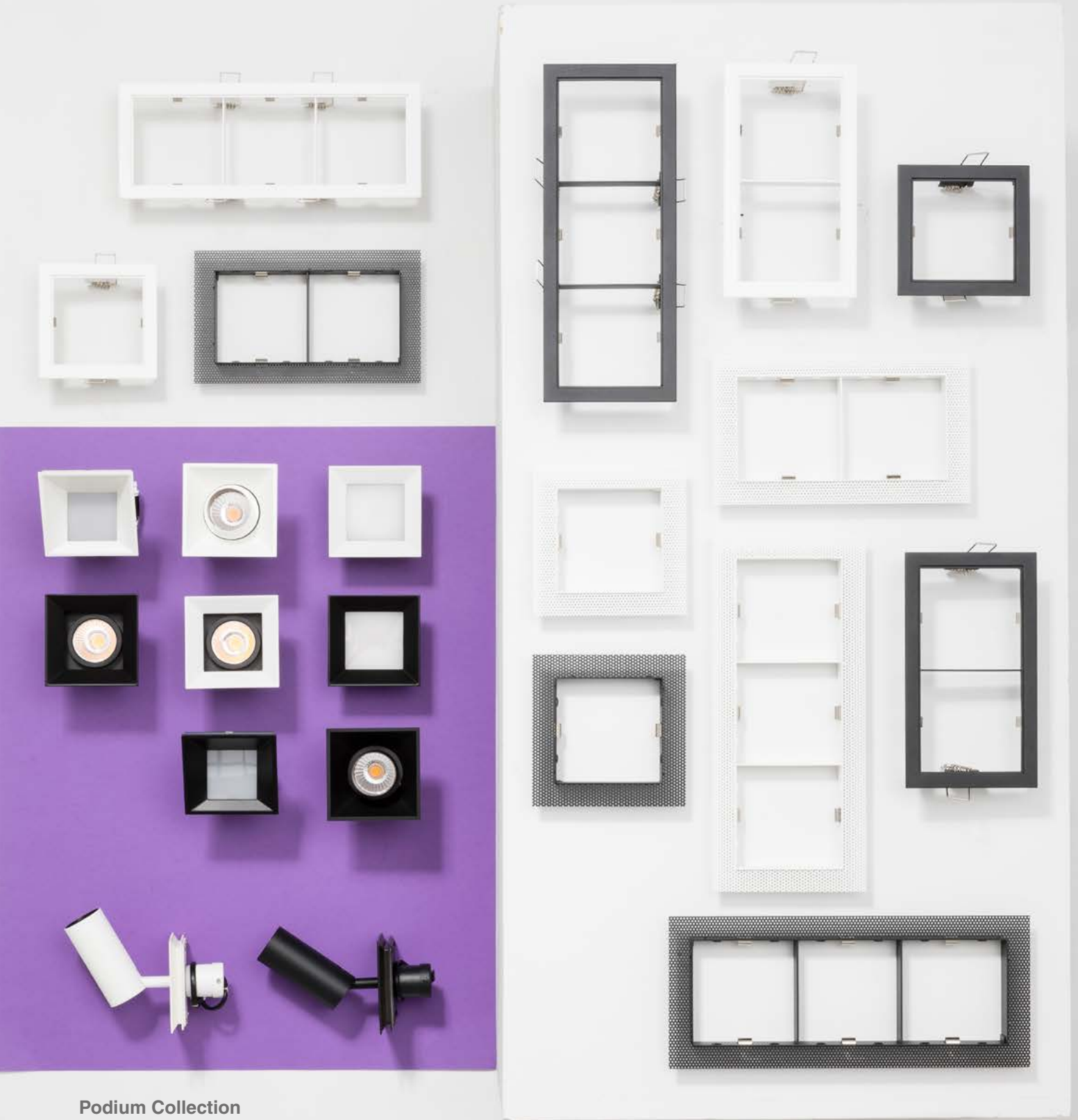

Podium Collection



Surface
355

MODULE
Modulo

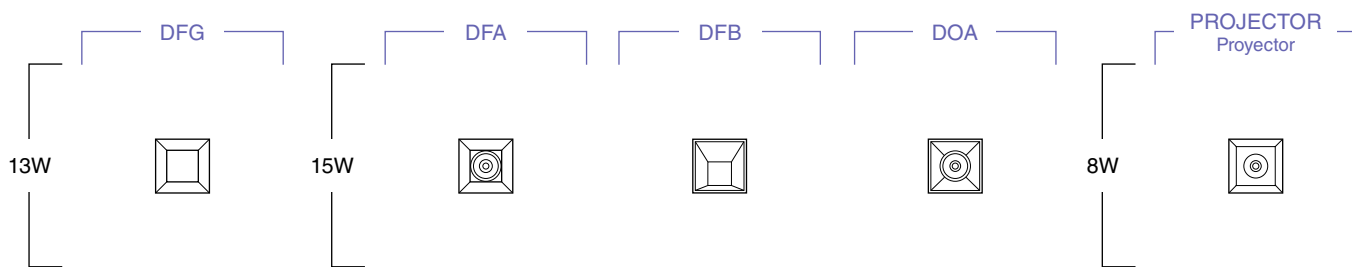

FRAME
Marco

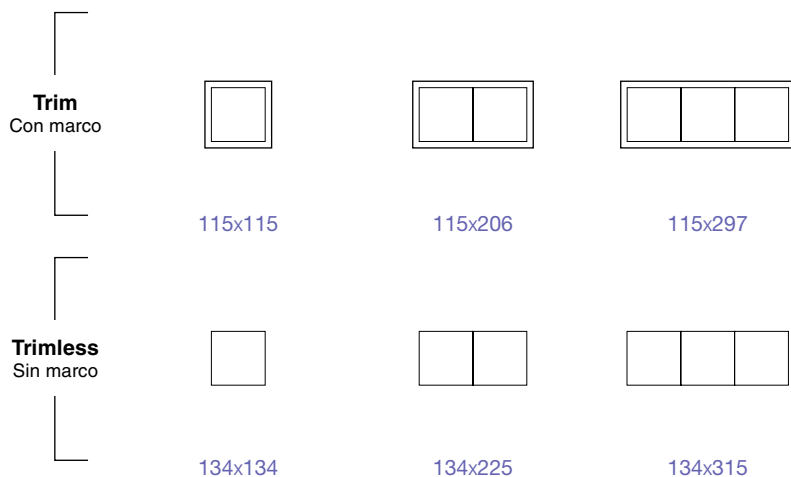

FINISH
Acabado



COLOR TEMPERATURE
Temperatura de color

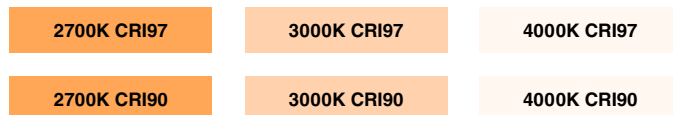

BEAM ANGLE
Ángulo de apertura

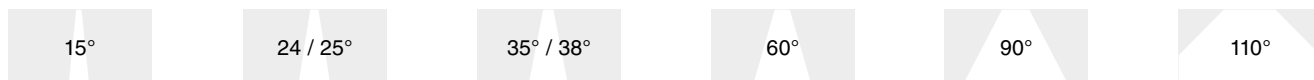

ACCESSORIES
Accesorios



CONTROL SYSTEM
Sistema de control



Highlights

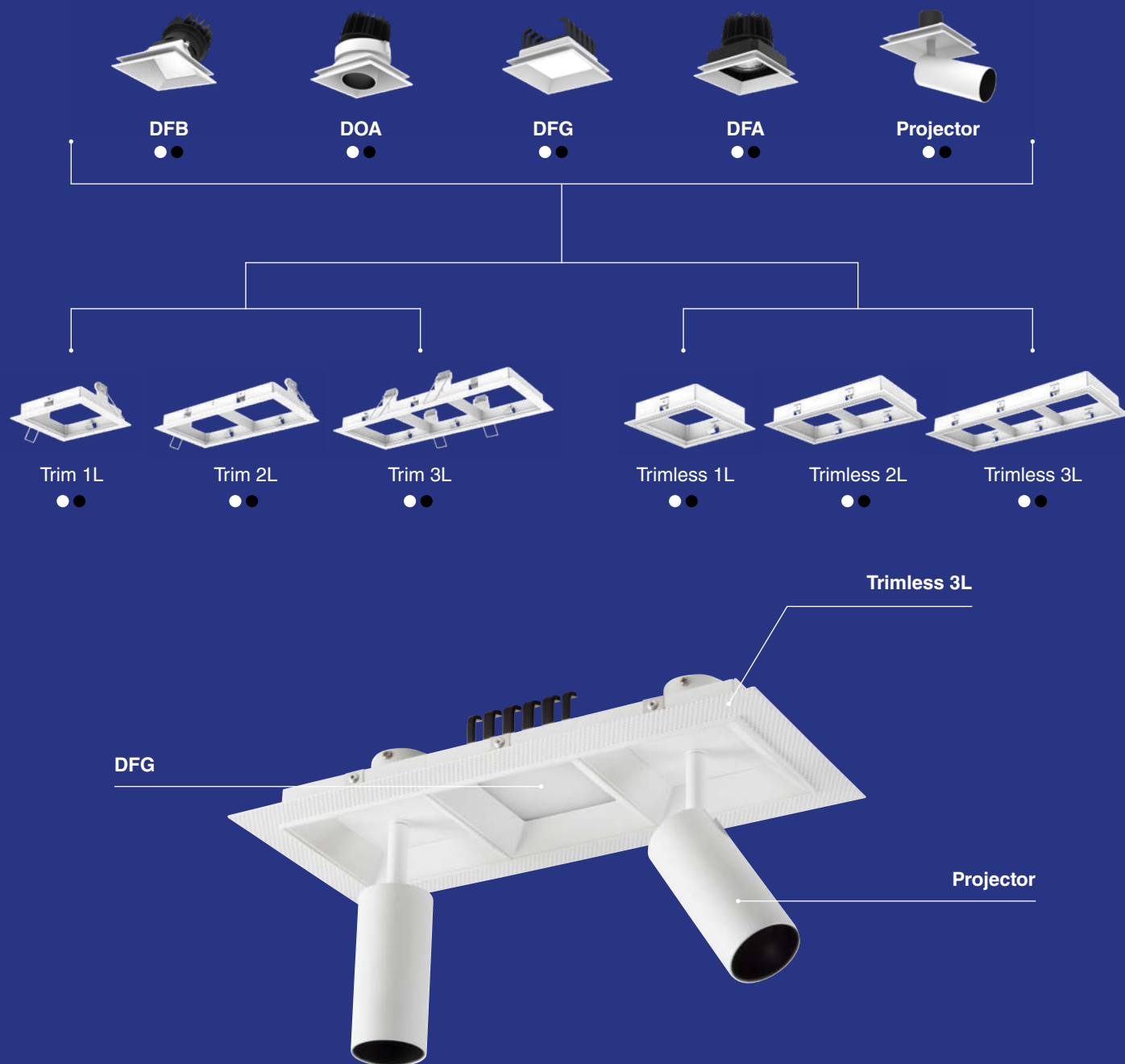

The recessed system has options with and without a frame of 1, 2 and 3 lights, making it possible to combine general, downlight, fixed and orientable accent and projector lighting optics into one product. The family is offered in 3 colour temperatures and high CRI.

El sistema empotrable cuenta con opciones con y sin marco de 1,2 y 3 luces pudiendo combinar en un mismo producto ópticas de iluminación general, bañador, acento fija y orientable y proyector. La familia se ofrece en 3 temperaturas de color y alto IRC.

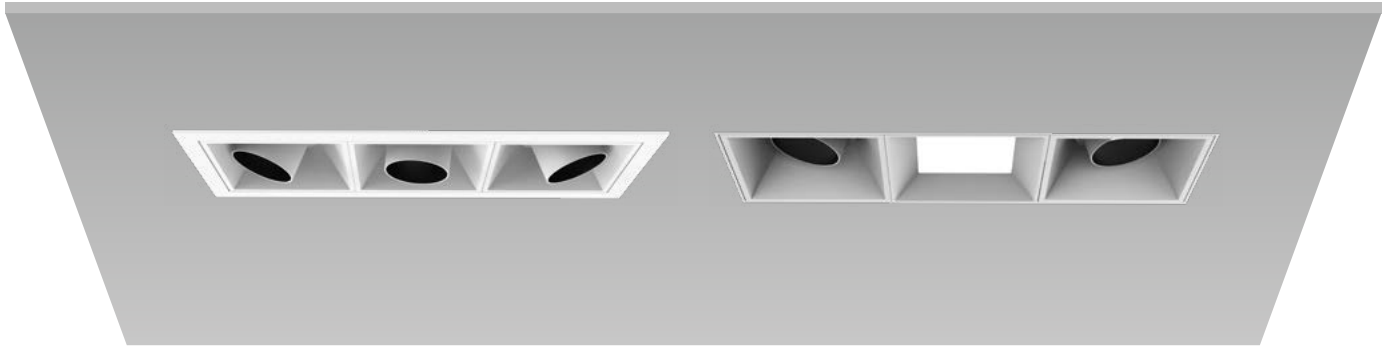



103x103

Trim 1L

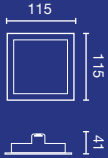

103x194

Trim 2L

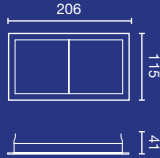

103x285

Trim 3L

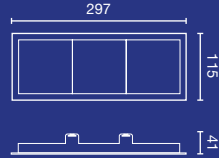

98x98

Trimless 1L

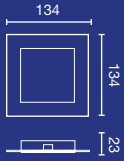

98x189

Trimless 2L

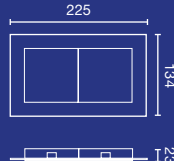

98x279

Trimless 3L

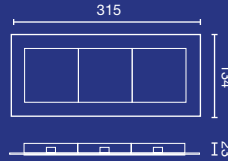

Honeycomb



Stripped Glass



Diffusion Sheet

Frames

Accessories for DFA&DOA

Trim 1L	Trim 2L	Trim 3L	Trimless 1L	Trimless 2L	Trimless 3L	Honeycomb	Stripped Glass	Diffusion sheet
● 034100011	● 034100021	● 034100031	● 034200011	● 034200021	● 034200031	034100098	034100097	034100099
● 034100012	● 034100022	● 034100032	● 034200012	● 034200022	● 034200032			



Residential



Restaurant

Beam Angle



15°

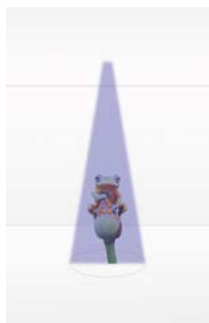

24/25°

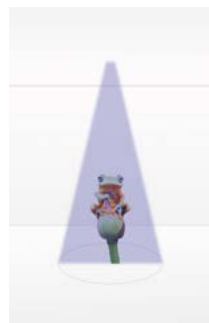

35/38°



60°



90°



110°

PODIUM DFA MODULE

incl. DIM 50.000hs L70 / B10 MacAdam 3 220-240V 50 / 60Hz 650°C



Family	Color T°	Beam Angle	Finish	Control System
0341 Podium DFA Module 15W	927 2700K CRI97	1 15°	1 White	W CASAMBI
	930 3000K CRI97	2 24°	2 Black	D DALI
	940 4000K CRI97	3 38°		C TRIAC
		6 60°		ON/OFF

0341 927 1 1 W

Example 034192711W — Podium DFA 15W 2700K CRI97 15° White Casambi

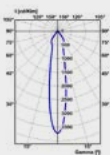

15°

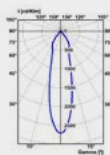

24°

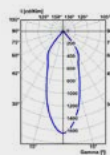

38°

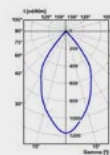

60°

Option	Color T°	CRI	Power	Lumen Output	Beam Angle
X27	2700K	97	15W	1121lm / 1026lm / 1036lm / 1060lm	15° / 24° / 38° / 60°
X30	3000K	97	15W	1156lm / 1058lm / 1068lm / 1093lm	15° / 24° / 38° / 60°
X40	4000K	97	15W	1191lm / 1090lm / 1100lm / 1126lm	15° / 24° / 38° / 60°

PODIUM DOA MODULE

incl. DIM 355° 20° 50.000hs L70 / B10 MacAdam 3 220-240V 50 / 60Hz 650°C

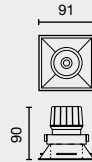

Family	Color T°	Beam Angle	Finish	Control System
0342 Podium DOA Module 15W	927 2700K CRI97	1 15°	1 White	W CASAMBI
	930 3000K CRI97	2 24°	2 Black	D DALI
	940 4000K CRI97	3 38°		C TRIAC
		6 60°		ON/OFF

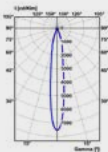

15°

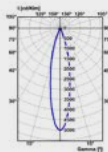

24°

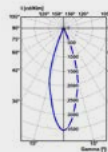

38°

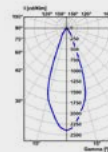

60°

Option	Color T°	CRI	Power	Lumen Output	Beam Angle
X27	2700K	97	15W	435lm / 439lm / 448lm / 456lm	15° / 24° / 38° / 60°
X30	3000K	97	15W	448lm / 453lm / 462lm / 470lm	15° / 24° / 38° / 60°
X40	4000K	97	15W	461lm / 467lm / 476lm / 484lm	15° / 24° / 38° / 60°

PODIUM DFB MODULE

incl. DIM 50.000hs L70 / B10 MacAdam 3 220-240V 50 / 60Hz 650°C

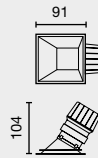

Family	Color T°	Beam Angle	Finish	Control System								
0344 Podium DFB Module 15W	927 2700K CRI97	9 90°	1 White	<table border="1"> <tr><td>W</td><td>CASAMBI</td></tr> <tr><td>D</td><td>DALI</td></tr> <tr><td>C</td><td>TRIAC</td></tr> <tr><td></td><td>ON/OFF</td></tr> </table>	W	CASAMBI	D	DALI	C	TRIAC		ON/OFF
	W		CASAMBI									
	D		DALI									
C	TRIAC											
	ON/OFF											
930 3000K CRI97	2 Black											
940 4000K CRI97												

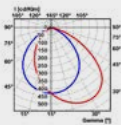

90°

Option	Color T°	CRI	Power	Lumen Output	Beam Angle
X27	2700K	97	15W	228lm	90°
X30	3000K	97	15W	235lm	90°
X40	4000K	97	15W	242lm	90°



PODIUM PROJECTOR MODULE

incl. DIM 355° 90° 50.000hs L70 / B10 MacAdam 3 220-240V 50 / 60Hz 650°C

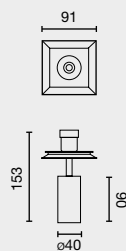

Family	Color T°	Beam Angle	Finish	Control System
0345 Podium Projector Module 8W	927 2700K CRI97	1 15°	1 White	W CASAMBI
	930 3000K CRI97	2 25°	2 Black	D DALI
	940 4000K CRI97			C TRIAC ON/OFF

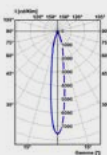

15°

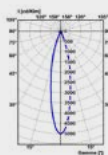

25°

Option	Color T°	CRI	Power	Lumen Output	Beam Angle
X27	2700K	97	8W	273lm / 273lm	15° / 25°
X30	3000K	97	8W	281lm / 281lm	15° / 25°
X40	4000K	97	8W	289lm / 289lm	15° / 25°

PODIUM DFG MODULE

incl. DIM 50.000hs L70 / B10 MacAdam 3 220-240V 50 / 60Hz 650°C



Family	Color T°	Beam Angle	Finish	Control System								
0343 Podium DFG Module 13W	927 2700K CRI90	0 110°	1 White	<table border="1"> <tr><td>W</td><td>CASAMBI</td></tr> <tr><td>D</td><td>DALI</td></tr> <tr><td>C</td><td>TRIAC</td></tr> <tr><td></td><td>ON/OFF</td></tr> </table>	W	CASAMBI	D	DALI	C	TRIAC		ON/OFF
	W		CASAMBI									
	D		DALI									
C	TRIAC											
	ON/OFF											
930 3000K CRI90	2 Black											
940 4000K CRI90												

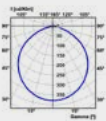

110°

Option	Color T°	CRI	Power	Lumen Output	Beam Angle
927	2700K	90	13W	648lm	110°
930	3000K	90	13W	668lm	110°
940	4000K	90	13W	688lm	110°

The BACKLIGHT panels are the perfect choice for efficiency and illuminating offices in an elegant way. These recessed panels provide soft and uniform lighting that promotes a comfortable and productive environment. Their discreet design easily integrates into the aesthetics of any office space. The uniform lighting they offer helps reduce glare and improve visual quality in the workplace.

Los paneles BACKLIGHT son la elección perfecta para iluminar oficinas de manera eficiente y elegante. Estos paneles empotrables proporcionan una iluminación suave y uniforme que favorece un ambiente cómodo y productivo. Su diseño discreto se integra fácilmente en la estética de cualquier espacio de oficina. La iluminación uniforme que ofrece contribuye a reducir el deslumbramiento y a mejorar la calidad visual en el lugar de trabajo.

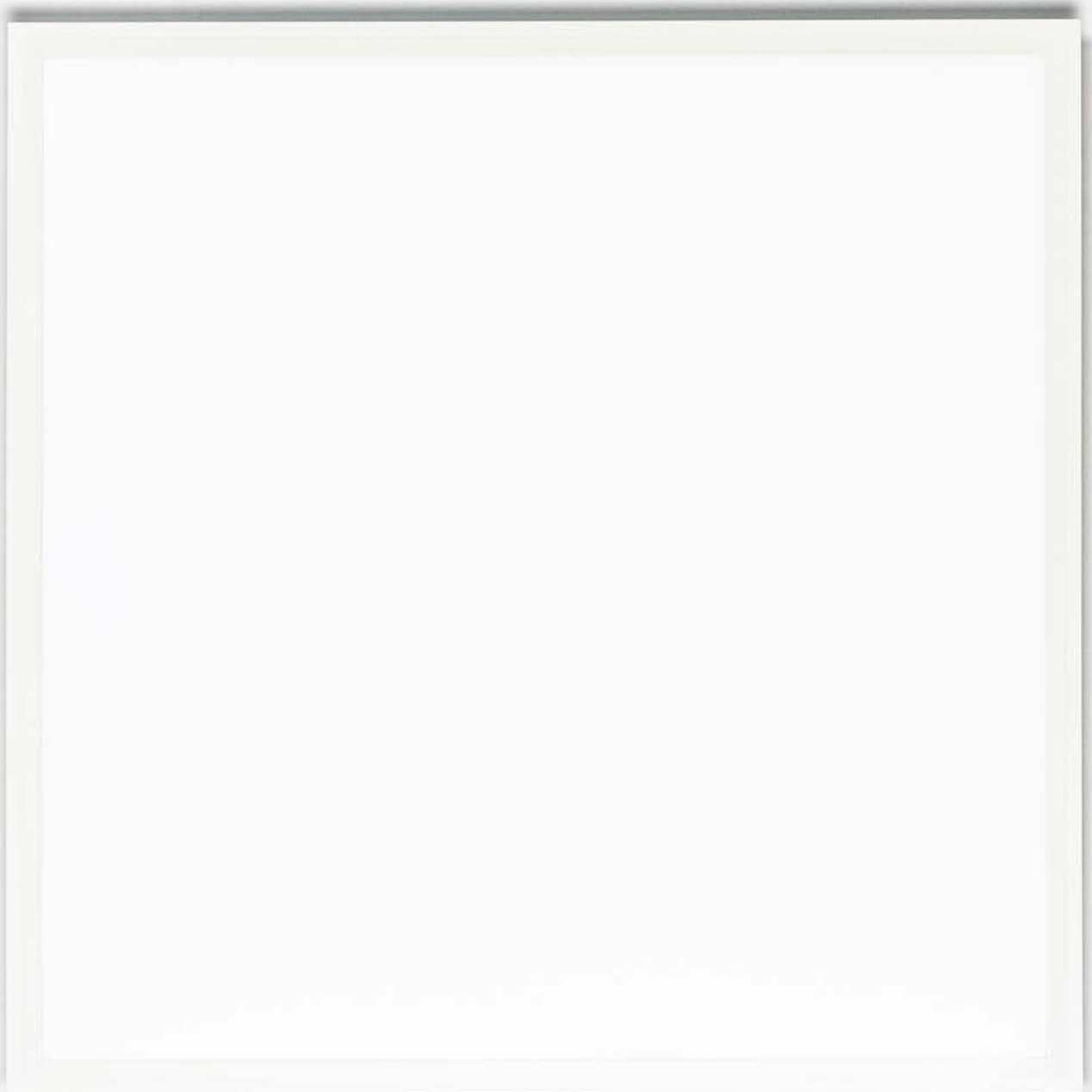

BACK LIGHT



Backlight
1195x295mm
36W



Backlight
595mm
36W



FINISH
Acabado

White
Blanco

COLOR TEMPERATURE
Temperatura de color

3000K CRI80

4000K CRI80

BEAM ANGLE
Ángulo de apertura

90°

CONTROL SYSTEM
Sistema de control



Highlights

Thanks to its easy installation and high energy efficiency, this panel becomes the ideal option for providing general lighting in large spaces. With a UGR glare index below 19, it is a perfect choice for office environments.

Gracias a su sencilla instalación y su alta eficiencia energética, este panel se convierte en la opción ideal para proveer iluminación general en espacios amplios. Con un índice de deslumbramiento UGR inferior a 19, resulta una elección perfecta para entornos de oficina.

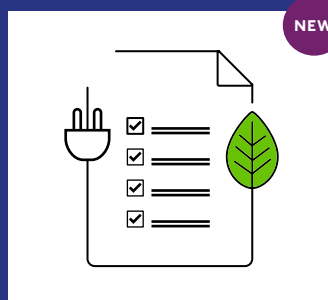

High Efficiency
Alta eficiencia



Easy Instalation modular ceiling
Techo modular de fácil instalación

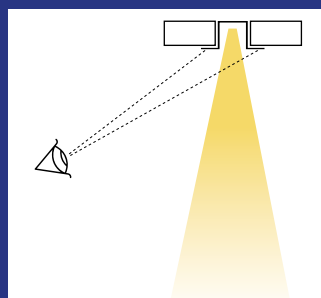

UGR<19



Office



Hospital

Beam Angle



90°



S U R F

E A C E

The Troop Surface model provides high-precision linear lighting with glare control through its UGR optics. Ideal for surface mounting in commercial spaces and offices, it combines modular design and lighting efficiency. Its uniform and comfortable light ensures a visually pleasant environment, seamlessly integrating into any architectural style.

El modelo Troop Surface ofrece una iluminación lineal de alta precisión, con control del deslumbramiento gracias a su óptica UGR. Ideal para superficies en espacios comerciales y oficinas, combina diseño modular y eficiencia lumínica. Su luz uniforme y confortable garantiza un ambiente visualmente agradable, integrándose perfectamente en cualquier estilo arquitectónico.



TROOP

NEW



SURFACE



TRIM
Con marco

WALL WASHER
Bañador de pared

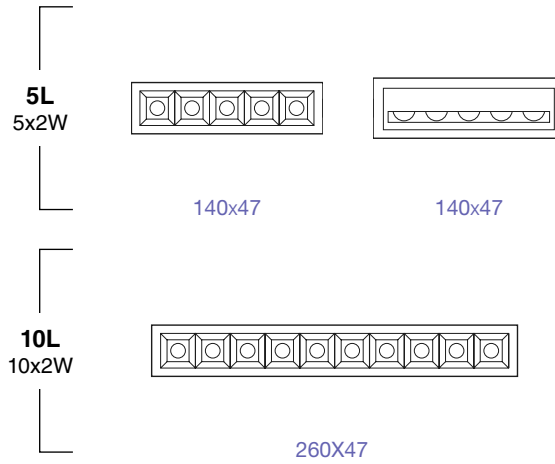

FINISH Acabado

- Black+Black**
Negro+Negro
- Black+White**
Negro+Blanco
- White+White**
Blanco+Blanco
- White+Black**
Blanco+Negro
- Black+Gold**
Negro+Oro
- White+Gold**
Blanco+Oro

COLOR TEMPERATURE Temperatura de color

- 2700K CRI90**
- 3000K CRI90**
- 4000K CRI90**

BEAM ANGLE Ángulo de apertura



CONTROL SYSTEM Sistema de control



CASAMBI



Highlights

Anti-glare optics
Óptica antideslumbrate

UGR

Reflector with dark light technology
Reflector con tecnología dark light

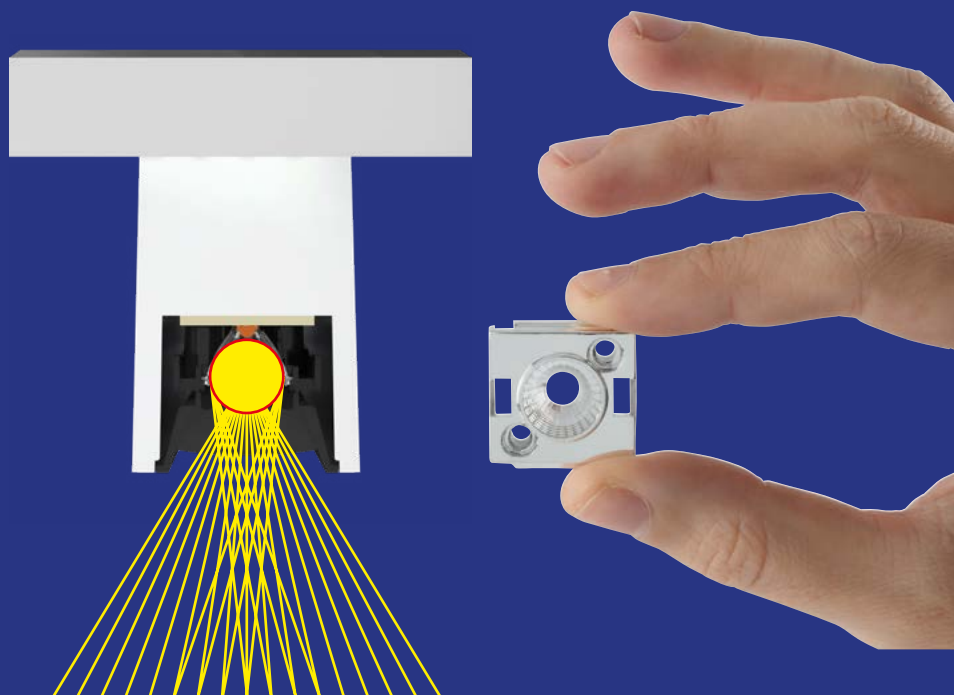

Linear design with circular light effect
Diseño lineal con efecto lumínico circular



Wall washer version
Versión bañador de pared



Several color temperatures
Varias temperaturas de color



Residential



Restaurant

Beam Angle

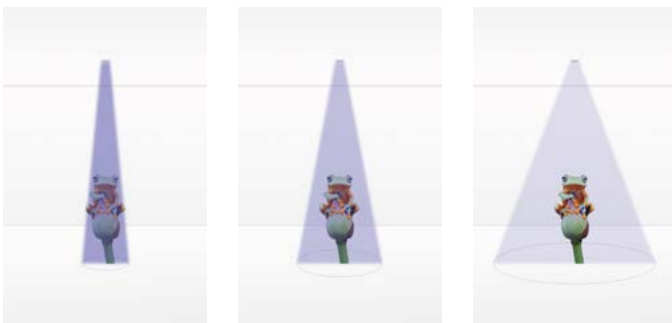

15°

36°

48°





TROOP SURFACE 5L

NEW

incl. DIM 50.000hs L70 / B10 MacAdam 3 700mA 14.28V 650°C UGR <16

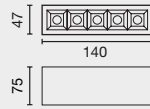
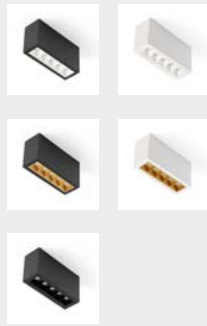

Family	Color T°	Beam Angle	Finish	Anti-Glare	Control System
43708 Troop Surface 5x2W	927 2700K CRI90	1 15°	1 White	1 White	C TRIAC ON/OFF
	930 3000K CRI90	3 36°	2 Black	2 Black	
	940 4000K CRI90	4 48°		4 Gold	

43708 927 1 1 1 W

Example 43708927111 — Troop surface 2W 2700K 15° White White

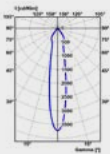

15°

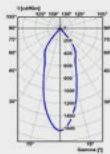

36°

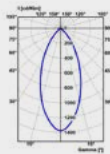

48°

Option	Color T°	CRI	Power	Lumen Output	Beam Angle
927	2700K	90	5x2W	672lm / 841lm / 828lm	15° / 36° / 48°
930	3000K	90	5x2W	692lm / 866lm / 853lm	15° / 36° / 48°
940	4000K	90	5x2W	712lm / 891lm / 878lm	15° / 36° / 48°

TROOP SURFACE WALLWASHER



incl. DIM 50.000hs L70 / B10 MacAdam 3 700mA 14.28V 650°C UGR <16

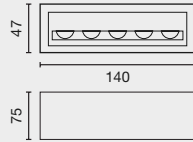

Family	Color T°	Beam Angle	Finish	Anti-Glare	Control System
43711 Troop Surface Wall Washer 5x2W	927 2700K CRI90	0 Asym	1 White	1 White	C TRIAC ON/OFF
	930 3000K CRI90		2 Black	2 Black	
	940 4000K CRI90				

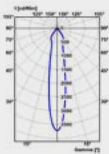

15°

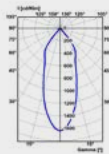

36°

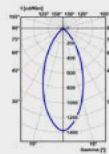

48°

Option	Color T°	CRI	Power	Lumen Output	Beam Angle
927	2700K	90	5x2W	519lm	90°
930	3000K	90	5x2W	535lm	36°
940	4000K	90	5x2W	551lm	48°

TROOP SURFACE 10L

NEW

incl. DIM 50.000hs L70 / B10 MacAdam 3 700mA 28.57V 650°C UGR <16

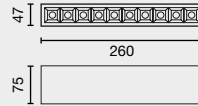
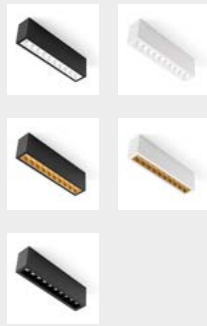

Family	Color T°	Beam Angle	Finish	Anti-Glare	Control System
43709 Troop Surface 10x2W	927 2700K CRI90	1 15°	1 White	1 White	W CASAMBI
	930 3000K CRI90	3 36°	2 Black	2 Black	D DALI
	940 4000K CRI90	4 48°		4 Gold	C TRIAC ON/OFF

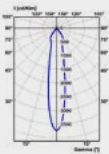

15°

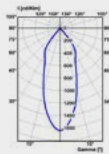

36°

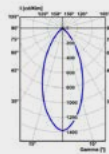

48°

Option	Color T°	CRI	Power	Lumen Output	Beam Angle
927	2700K	90	10x2W	1379lm / 1681lm / 1755lm	15° / 36° / 48°
930	3000K	90	10x2W	1422lm / 1733lm / 1809lm	15° / 36° / 48°
940	4000K	90	10x2W	1465lm / 1785lm / 1863lm	15° / 36° / 48°



**Need consulting
for your project?**
¿Necesitas
asesoramiento
para tu proyecto?





BLIT is a product with a minimalist design and a rectangular shape. Designed for surface installation on ceilings and walls, it provides indirect general lighting. Its elegant design seamlessly integrates into any environment, offering soft and ambient lighting that creates a cozy atmosphere. BLIT is the ideal choice for achieving discreet and effective lighting that enhances the aesthetics of the space.

BLIT es un producto de diseño minimalista y forma rectangular. Pensado para una instalación en superficie en techos y paredes, brinda una iluminación general de manera indirecta. Su diseño elegante se integra perfectamente en cualquier entorno, proporcionando una iluminación suave y ambiental que crea una atmósfera acogedora. BLIT es la elección ideal para lograr una iluminación discreta y efectiva que realza la estética del espacio.



BLIT

SURFACE



BLIT Collection



Track
51

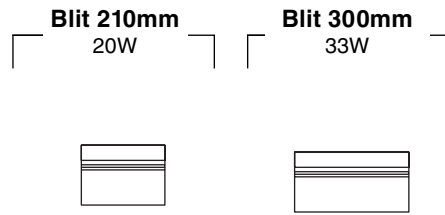

FINISH
Acabado

● **Black**
Negro

○ **White**
Blanco

COLOR TEMPERATURE
Temperatura de color

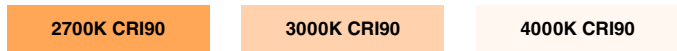

BEAM ANGLE
Ángulo de apertura

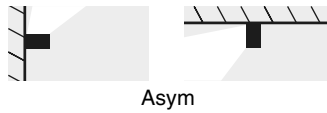

CONTROL SYSTEM
Sistema de control



Highlights

Available in two power options and made entirely of aluminum and glass, BLIT provides general illumination through indirect light. Its minimalist design with straight lines allows the luminaire to integrate perfectly into a wide range of spaces, whether installed on the wall or ceiling.

Disponible en dos opciones de potencia y fabricado íntegramente en aluminio y cristal, BLIT proporciona una iluminación general mediante luz indirecta. Su diseño minimalista de líneas rectas permite que la luminaria se integre perfectamente en una amplia gama de espacios, ya sea instalada en la pared o en el techo.

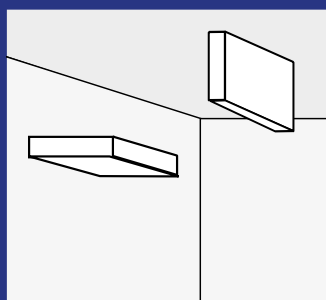

Wall & ceiling
Pared y techo



High CRI
Alto IRC



Several color temperatures
Varias temperaturas de color



Restaurant



Home

Beam Angle



Asym°

BLIT

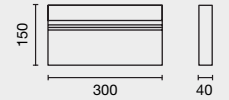
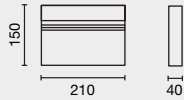
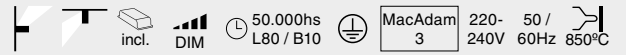

Family	Color T°	Beam Angle	Finish	Control System
0125 Blit 210mm 20w	927 2700K CRI90	9 Asym	1 White	D
0126 Blit 300mm 33w	930 3000K CRI90		2 Black	W
	940 4000K CRI90			ON/OFF

0125 **927** **9** **1** **D**

Example **012592791D** — Blit 210mm 20W 2700K CRI90 White Dali

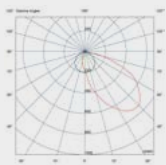

Asym

Option	Color T°	CRI	Power	Lumen Output	Beam Angle
927	2700K	90	20W	1633lm	Asym
		90	33W	3412lm	Asym
930	3000K	90	20W	1684lm	Asym
		90	33W	3517lm	Asym
940	4000K	90	20W	1734lm	Asym
		90	33W	3623lm	Asym



The SCUBA UGR luminaire is a versatile and watertight solution suitable for surface or suspension installation. It provides high-quality lighting with a Unified Glare Rating (UGR) of less than 19, making it perfect for office environments. Its industrial style adds a touch of modernity and uniqueness to any workspace while providing efficient and comfortable lighting. It is the ideal choice for creating office environments with an industrial aesthetic and optimal lighting.

La luminaria SCUBA UGR es una solución versátil y estanca, adecuada para su instalación en superficie o suspensión. Brinda una iluminación de alta calidad con un valor UGR (Deslumbramiento Unificado) menor a 19, lo que la hace perfecta para entornos de oficina. Su estilo industrial añade un toque de modernidad y singularidad a cualquier espacio de trabajo, a la vez que proporciona una iluminación eficiente y confortable. Es la elección ideal para crear ambientes de oficina con una estética industrial y una iluminación óptima.



SCUBA



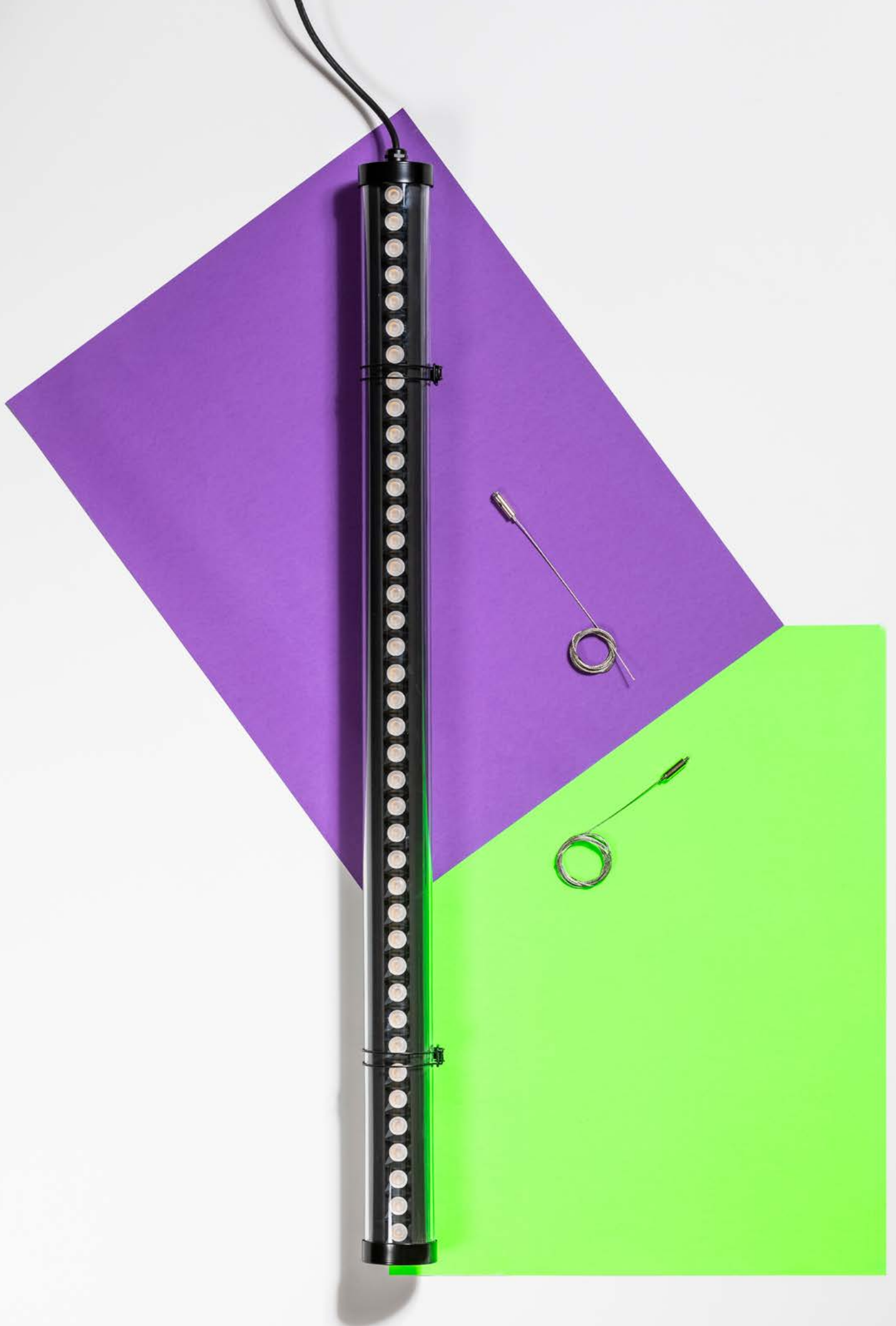

Scuba 1200mm
36W

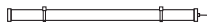

FINISH
Acabado

● **Black**
Negro

COLOR TEMPERATURE
Temperatura de color

3000K

4000K

ACCESSORIES
Accesorios



Suspended

CONTROL SYSTEM
Sistema de control



CASAMBI

Highlights

With a low UGR glare index, this linear luminaire becomes the ideal choice for both office environments and industrial spaces requiring a high IP rating. In addition, its remarkable impact resistance ensures reliable performance even in demanding work environments. With these features, the luminaire not only provides quality lighting but also ensures long-term durability and safety in various work settings.

Con un bajo índice de deslumbramiento UGR, esta luminaria lineal se convierte en la elección ideal tanto para entornos de oficina como para espacios industriales que requieran una clasificación de protección IP alta. Además, su notable resistencia al impacto garantiza un rendimiento confiable incluso en entornos de trabajo exigentes. Con estas características, la luminaria no solo proporciona una iluminación de calidad, sino que también asegura durabilidad y seguridad a largo plazo en diversos entornos laborales.

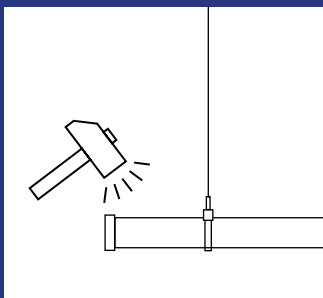

IK10

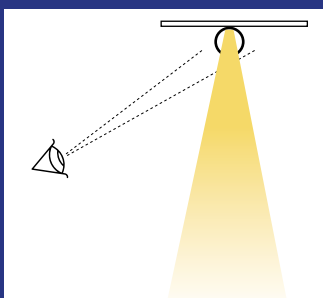

UGR < 19



Suspended option
Opción colgante



IP65



High CRI
Alto IRC





Suspended

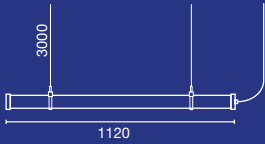

Accessories

Suspended

● 042500099

Suspended DALI

● 042500099D



Office

Beam Angle



50°

SCUBA UGR 36W

incl. DIM 50.000hs L80 / B10 MacAdam 3 IP65 220-240V 50 / 60Hz 650°C

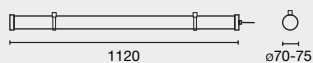

Family	Color T°	Beam Angle	Finish	Control System
0425 Scuba UGR 36W	930 3000K CRI90 940 4000K CRI90	5 50°	2 Black	W CASAMBI D DALI ON/OFF

0425 930 5 2 W

Example **042593052W** — Scuba UGR 36W 3000K CRI90 50° Black Casambi

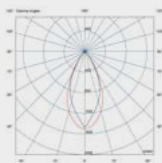

60°

Option	Color T°	CRI	Power	Lumen Output	Beam Angle
930	3000K	90	36W	2946lm	50°
940	4000K	90	36W	3034lm	50°





PROOFLINE is a rugged and high-performance linear luminaire designed for demanding environments. With an IP67 rating, it offers exceptional resistance to water and dust, making it ideal for applications in parking lots and industrial spaces where durability and reliability are crucial. Thanks to its high luminous efficiency up to 150lm/w, it provides efficient and bright lighting while reducing energy consumption. It is an ideal solution for challenging environments that require durable and efficient lighting.

PROOFLINE es una luminaria lineal resistente y de alto rendimiento diseñada para entornos exigentes. Con clasificación IP67, ofrece una excepcional resistencia al agua y al polvo, lo que la hace ideal para aplicaciones en estacionamientos y espacios industriales donde la durabilidad y la fiabilidad son fundamentales. Gracias a su alta eficiencia lumínica de hasta 150lm/w, proporciona una iluminación eficiente y brillante a la vez que reduce el consumo energético. Es una solución ideal para entornos desafiantes que requieren de una iluminación duradera y eficiente.

PROOF LINE





Proofline

[27 - 33 - 39 - 45W]



FINISH

Acabado



White
Blanco

COLOR TEMPERATURE

Temperatura de color

3000K CRI80

4000K CRI80

CONTROL SYSTEM

Sistema de control



CASAMBI

Highlights

Its high efficiency makes this luminaire the ideal option for extensive spaces that demand constant illumination, such as parking lots. Its impact resistance ensures exceptional durability, ensuring flawless operation, providing reliable and long-lasting lighting over time.

Su alta eficiencia convierte a esta luminaria en la opción ideal para espacios extensos que demandan iluminación constante, como por ejemplo, parkings. Su resistencia al impacto garantiza una durabilidad excepcional, lo que asegura un funcionamiento impecable, proporcionando una iluminación fiable y duradera a lo largo del tiempo.



IP65

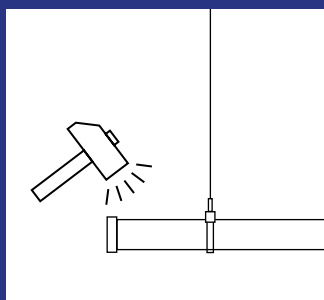

IK10

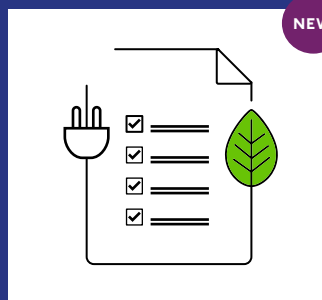

High Efficiency
Alta eficiencia

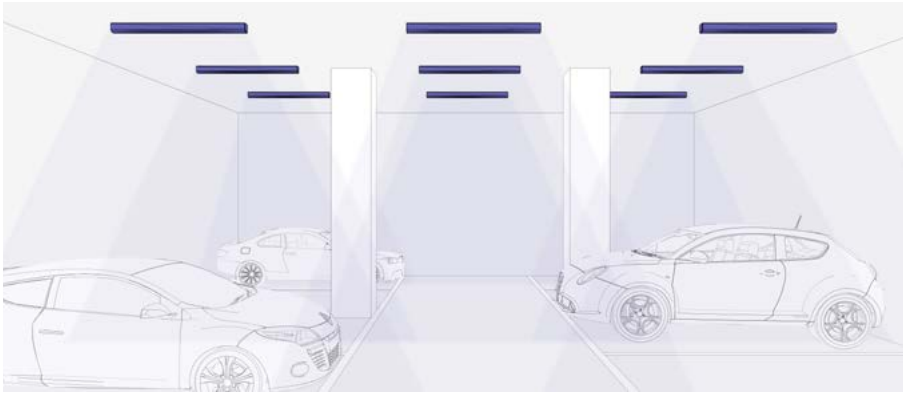





Parking



Beam Angle





120°

PROOFLINE 45W



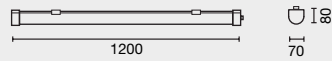



Family	Color T°	Beam Angle	Finish	Control System
0424 Proofline 45W	830 3000K CRI80 840 4000K CRI80	9 120°	3 White	D  W  ON/OFF

0424 **830** **9** **1** **D**

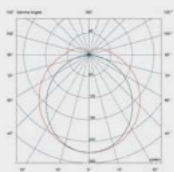
Example **042483091D** — Proofline 45W 3000K CRI80 120° White Dali



120°

Option	Color T°	CRI	Power	Lumen Output	Beam Angle
830	3000k	80	27W	3915lm	120°
840	4000k	80	27W	4032lm	120°
830	3000k	80	33W	4766lm	120°
840	4000k	80	33W	4908lm	120°
830	3000k	80	39W	5576lm	120°
840	4000k	80	39W	5743lm	120°
830	3000k	80	45W	6369lm	120°
840	4000k	80	45W	6914lm	120°

*This product integrates a driver that allows manual adjustment of power. To change the power, please refer to the instructions.
 *Este producto integra un driver que permite cambiar la potencia de forma manual. Para realizar el cambio de potencia consultar el instructivo.



FOST SURFACE meets the need to accentuate what needs to be highlighted. A minimalist design that is easy to integrate into any space, bringing the architecture to the forefront. It can be installed on both the vertical and horizontal plane without the need for a track.

FOST SURFACE da risposta a la necesidad de poner acento a lo que debe ser destacado. Un diseño minimalista de fácil integración en cualquier espacio dando protagonismo a la arquitectura. Su instalación es posible tanto en el plano vertical como horizontal sin la necesidad de la utilización de carril.



F O S T



S U R F A C E



FOST Collection



Track
39



Recessed
227



Pulldown
237



Ceiling
331



Pendant
379

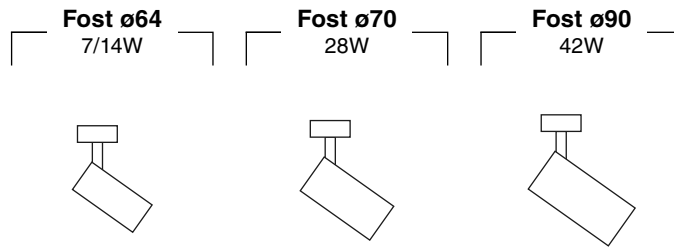

FINISH
Acabado

Black
Negro

White
Blanco

COLOR TEMPERATURE
Temperatura de color

2700K CRI90	3000K CRI90	4000K CRI90
2700K CRI97	3000K CRI97	4000K CRI97
MEAT	BREAD	FASHION

BEAM ANGLE
Ángulo de apertura



ACCESSORIES
Accesorios



CONTROL SYSTEM
Sistema de control





White Ring



Copper Ring



Striped Glass



Long Snoot

Its multiple accessories and combinations facilitate the personalisation of the products, giving it certain architectural relevance and at the same time making it possible to modify the beam or reduce glare.

Sus múltiples accesorios y combinaciones facilitan la personalización del producto que hace posible la modificación de haz o reducir el deslumbramiento.



Spread Glass



Honeycomb



Without accessory



Spread Glass



Striped Glass

Accesorios

	Honeycomb	White Ring	Copper Ring	Spread Glass	Long Snoot	Striped Glass
ø64	011700094	011700099	011700098	011700097	011700095	011700096
ø70	011800094	011800099	011800098	011800097	011800095	011800096
ø90	012100094	012100099	012100098	012100097	012100095	012100096

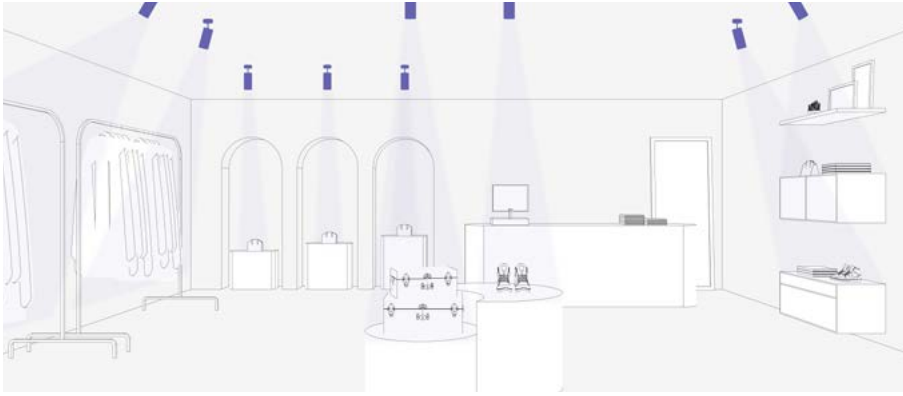

Retail



Restaurant

Beam Angle



17/18°

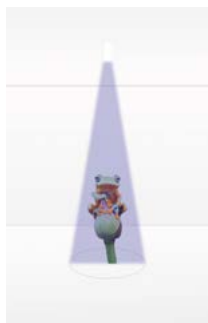

23/25°

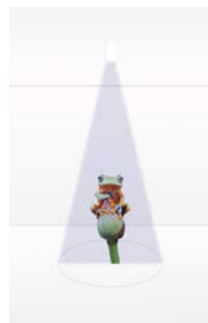

35/36/38°



60°

FOST SURFACE ø64

incl. 355° 90° 50.000hs L80 / B10 MacAdam 2&3 220-240V 50 / 60Hz 650°C

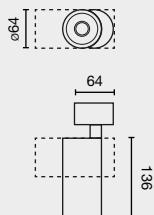

Family

Color T°

Beam Angle

Finish

N

0129	Fost surface ø64 7W
0119	Fost surface ø64 14W

927	2700K CRI90
930	3000K CRI90
940	4000K CRI90
X27	2700K CRI97
X30	3000K CRI97
X40	4000K CRI97

1	17°
2	25°
3	35°
6	60°

1	White
2	Black

0119

927

1

1

Example **011992711** — Fost Surface ø64 14W 2700K CRI90 17° White

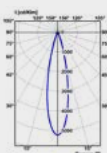

17°

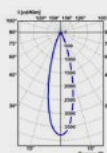

25°

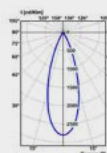

35°

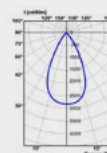

60°

Option	Color T°	CRI	Power	Lumen Output	Beam Angle
927	2700K	90	14W	950lm / 1076lm / 1127lm / 1248lm	17° / 25° / 35° / 60°
X27	2700K	97	14W	855lm / 968lm / 1014lm / 1123lm	17° / 25° / 35° / 60°
930	3000K	90	14W	979lm / 1109lm / 1162lm / 1287lm	17° / 25° / 35° / 60°
X30	3000K	97	14W	881lm / 998lm / 1046lm / 1159lm	17° / 25° / 35° / 60°
940	4000K	90	14W	1008lm / 1142lm / 1197lm / 1326lm	17° / 25° / 35° / 60°
X40	4000K	97	14W	908lm / 1028lm / 1077lm / 1193lm	17° / 25° / 35° / 60°

Option	Color T°	CRI	Power	Lumen Output	Beam Angle
927	2700K	90	7W	546lm / 519lm / 648lm / 718lm	17° / 25° / 35° / 60°
X27	2700K	97	7W	492lm / 557lm / 583lm / 646lm	17° / 25° / 35° / 60°
930	3000K	90	7W	563lm / 638lm / 668lm / 740lm	17° / 25° / 35° / 60°
X30	3000K	97	7W	507lm / 574lm / 601lm / 666lm	17° / 25° / 35° / 60°
940	4000K	90	7W	580lm / 657lm / 688lm / 762lm	17° / 25° / 35° / 60°
X40	4000K	97	7W	522lm / 591lm / 619lm / 686lm	17° / 25° / 35° / 60°

FOST SURFACE $\phi 70$

incl. DIM 355° 90° 50.000hs L80 / B10 MacAdam 2&3 220-240V 50 / 60Hz 650°C

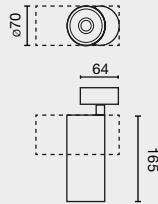

Family	Color T°	Beam Angle	Finish	Control System
0120 Fost surface $\phi 70$ 28W	927 2700K CRI90	1 18° 2 23° 3 36° 6 60°	1 White	C TRIAC ON/OFF
	930 3000K CRI90		2 Black	
	940 4000K CRI90			
	X27 2700K CRI97			
	X30 3000K CRI97			
	X40 4000K CRI97			

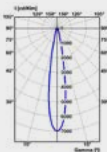

18°

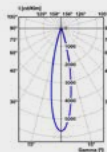

23°

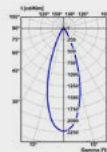

36°



60°

Option	Color T°	CRI	Power	Lumen Output	Beam Angle
927	2700K	90	28W	2982lm / 2987lm / 2732lm / 2436lm	18° / 23° / 36° / 60°
X27		97	28W	2684lm / 2688lm / 2459lm / 2193lm	18° / 23° / 36° / 60°
930	3000K	90	28W	3075lm / 3080lm / 2817lm / 2512lm	18° / 23° / 36° / 60°
X30		97	28W	2767lm / 2771lm / 2535lm / 2261lm	18° / 23° / 36° / 60°
940	4000K	90	28W	3167lm / 3172lm / 2902lm / 2588lm	18° / 23° / 36° / 60°
X40		97	28W	2850lm / 2855lm / 2611lm / 2328lm	18° / 23° / 36° / 60°

FOST SURFACE ø90

incl. DIM 355° 90° 50.000hs L80 / B10 MacAdam 2&3 220-240V 50 / 60Hz 650°C

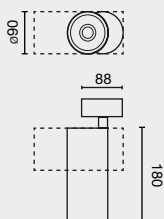

Family	Color T°	Beam Angle	Finish	Control System
0121 Fost surface ø90 42W	927 2700K CRI90	1 18° 2 23° 3 38°	1 White	D DALI C TRIAC ON/OFF
	930 3000K CRI90		2 Black	
	940 4000K CRI90			
	X27 2700K CRI97			
	X30 3000K CRI97			
	X40 4000K CRI97			
	MT MEAT			
	BR BREAD			
	FS FASHION			

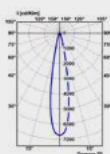

18°

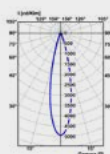

23°

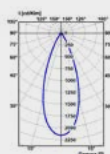

38°

Option	Color T°	CRI	Power	Lumen Output	Beam Angle
927	2700K	90	42W	3374lm / 3656lm / 3856lm	18° / 23° / 38°
X27	2700K	97	42W	3036lm / 3290lm / 3470lm	18° / 23° / 38°
930	3000K	90	42W	3478lm / 3769lm / 3975lm	18° / 23° / 38°
X30	3000K	97	42W	3130lm / 3392lm / 3577lm	18° / 23° / 38°
940	4000K	90	42W	3582lm / 3882lm / 4094lm	18° / 23° / 38°
X40	4000K	97	42W	3224lm / 3493lm / 3684lm	18° / 23° / 38°
MT	3100K	-	42W	2468lm / 2688lm / 2819lm	18° / 23° / 38°
BR	2500K	-	42W	3330lm / 3627lm / 3803lm	18° / 23° / 38°
FS	3100K	-	42W	3418lm / 3723lm / 3903lm	18° / 23° / 38°



Surface light fixture suitable for ceilings which do not offer recessed mounting. The versatility of sizes and optics of FOST CEILING makes it a perfect fixed overhead application solution for commercial spaces, hotels, restaurants, retail and even domestic spaces due to its various colour temperature and CRI options.

Luminaria de superficie indicada para techos sin posibilidad de empotramiento. La versatilidad de tamaños y ópticas de FOST CEILING lo convierten en una solución perfecta de aplicación fija cenital para espacios comerciales, hoteles, restauración, retail e incluso espacios domésticos por sus varias opciones en temperatura de color y IRC.



F O S T



C E I L I N G



FOST Collection



Track
39



Recessed
227



Pulldown
237



Surface
321



Pendant
379

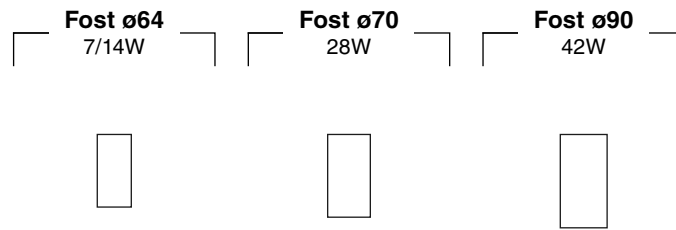

FINISH
Acabado

- Black**
Negro
 White
Blanco

COLOR TEMPERATURE
Temperatura de color

2700K CRI90	3000K CRI90	4000K CRI90
2700K CRI97	3000K CRI97	4000K CRI97
MEAT	BREAD	FASHION

BEAM ANGLE
Ángulo de apertura



ACCESSORIES
Accesorios

- | | | |
|---|---|--|
| 
Honeycomb | 
Long Snoot | 
Striped Glass |
| 
Spread Glass | 
White Ring | 
Copper Ring |

CONTROL SYSTEM
Sistema de control





White Ring



Copper Ring



Striped Glass



Long Snoot

Its multiple accessories and combinations facilitate the product's personalisation, giving it certain architectural relevance and at the same time making it possible to modify the beam or reduce glare.

Sus múltiples accesorios y combinaciones facilitan la personalización del producto, que hace posible la modificación de haz o reducir el deslumbramiento.



Spread Glass



Honeycomb



Without accessory



Spread Glass



Striped Glass

Accesorios

	Honeycomb	White Ring	Copper Ring	Spread Glass	Long Snoot	Striped Glass
ø64	011700094	011700099	011700098	011700097	011700095	011700096
ø70	011800094	011800099	011800098	011800097	011800095	011800096
ø90	012100094	012100099	012100098	012100097	012100095	012100096

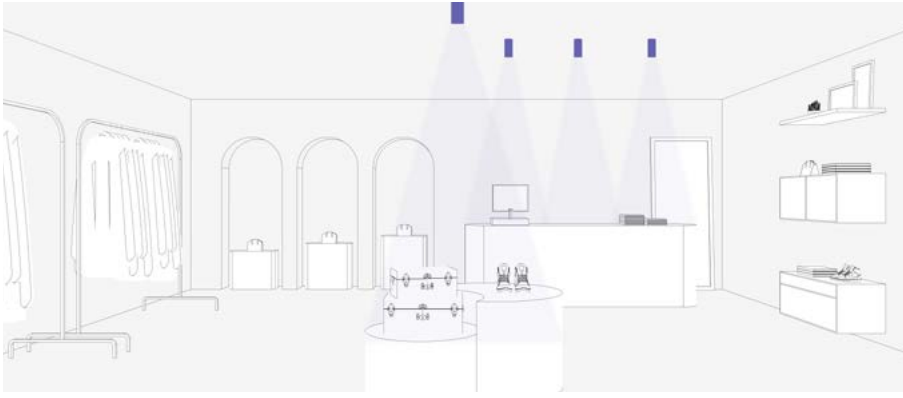

Retail



Restaurant

Beam Angle



17/18°

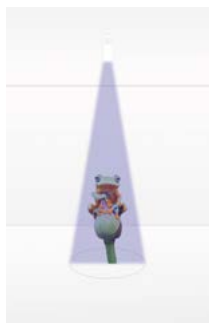

23/25°

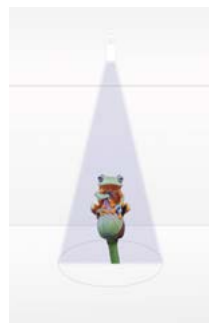

35/36/38°



60°

FOST CEILING ø64

incl. 50.000hs L80 / B10 MacAdam 2&3 220-240V 50 / 60Hz 650°C



Family

Color T°

Beam Angle

Finish

N

0509	Fost ceiling ø64 7W	927	2700K CRI90	1	17°	1	White
0510	Fost ceiling ø64 14W	930	3000K CRI90	2	25°	2	Black
		940	4000K CRI90	3	35°		
		X27	2700K CRI97	6	60°		
		X30	3000K CRI97				
		X40	4000K CRI97				

0510

927

1

1

Example **051092711** — Fost Ceiling ø64 14W 2700K CRI90 17° White

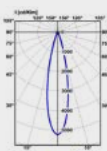

17°

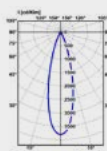

25°

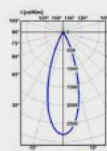

35°

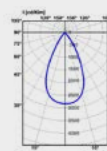

60°

Option	Color T°	CRI	Power	Lumen Output	Beam Angle
927	2700K	90	14W	950lm / 1076lm / 1127lm / 1248lm	17° / 25° / 35° / 60°
X27		97	14W	855lm / 1968lm / 1014lm / 1123lm	17° / 25° / 35° / 60°
930	3000K	90	14W	979lm / 1109lm / 1162lm / 1287lm	17° / 25° / 35° / 60°
X30		97	14W	881lm / 998lm / 1046lm / 1159lm	17° / 25° / 35° / 60°
940	4000K	90	14W	1008lm / 1142lm / 1197lm / 1326lm	17° / 25° / 35° / 60°
X40		97	14W	908lm / 1028lm / 1077lm / 1193lm	17° / 25° / 35° / 60°

Option	Color T°	CRI	Power	Lumen Output	Beam Angle
927	2700K	90	7W	546lm / 519lm / 648lm / 718lm	17° / 25° / 35° / 60°
X27		97	7W	492lm / 557lm / 583lm / 646lm	17° / 25° / 35° / 60°
930	3000K	90	7W	563lm / 638lm / 668lm / 740lm	17° / 25° / 35° / 60°
X30		97	7W	507lm / 574lm / 601lm / 666lm	17° / 25° / 35° / 60°
940	4000K	90	7W	580lm / 657lm / 688lm / 762lm	17° / 25° / 35° / 60°
X40		97	7W	522lm / 591lm / 619lm / 686lm	17° / 25° / 35° / 60°

FOST CEILING ø70

incl. 50.000hs L80 / B10 MacAdam 2&3 220-240V 50 / 60Hz 650°C



Family	Color T°	Beam Angle	Finish	Control System
0511 Fost ceiling ø70 28W	927 2700K CRI90	1 18°	1 White	C TRIAC ON/OFF
	930 3000K CRI90	2 23°	2 Black	
	940 4000K CRI90	3 36°		
	X27 2700K CRI97	6 60°		
	X30 3000K CRI97			
	X40 4000K CRI97			

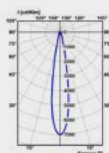

18°

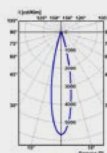

23°

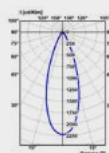

36°

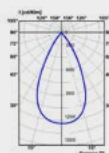

60°

Option	Color T°	CRI	Power	Lumen Output	Beam Angle
927	2700K	90	28W	2982lm / 2987lm / 2732lm / 2436lm	18° / 23° / 36° / 60°
X27		97			
930	3000K	90	28W	3075lm / 3080lm / 2817lm / 2512lm	18° / 23° / 36° / 60°
X30		97			
940	4000K	90	28W	3167lm / 3172lm / 2902lm / 2588lm	18° / 23° / 36° / 60°
X40		97			

FOST CEILING ø90

incl. DIM 50.000hs L80 / B10 MacAdam 2&3 220-240V 50 / 60Hz 650°C



Family	Color T°	Beam Angle	Finish	Control System
0512 Fost ceiling ø90 42W	927 2700K CRI90	1 18° 2 23° 3 38°	1 White	D DALI
	930 3000K CRI90		2 Black	C TRIAC
	940 4000K CRI90			ON/OFF
	X27 2700K CRI97			
	X30 3000K CRI97			
	X40 4000K CRI97			
	MT MEAT			
	BR BREAD			
	FS FASHION			

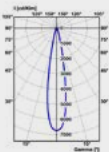

18°

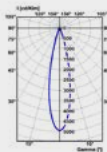

23°

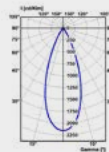

38°

Option	Color T°	CRI	Power	Lumen Output	Beam Angle
927	2700K	90	42W	3374lm / 3656lm / 3856lm	18° / 23° / 38°
X27	2700K	97	42W	3036lm / 3290lm / 3470lm	18° / 23° / 38°
930	3000K	90	42W	3478lm / 3769lm / 3975lm	18° / 23° / 38°
X30	3000K	97	42W	3130lm / 3392lm / 3577lm	18° / 23° / 38°
940	4000K	90	42W	3582lm / 3882lm / 4094lm	18° / 23° / 38°
X40	4000K	97	42W	3224lm / 3493lm / 3684lm	18° / 23° / 38°
MT	3100K	-	42W	2468lm / 2688lm / 2819lm	18° / 23° / 38°
BR	2500K	-	42W	3330lm / 3627lm / 3803lm	18° / 23° / 38°
FS	3100K	-	42W	3418lm / 3723lm / 3903lm	18° / 23° / 38°





DOMIO is a family of circular light fixtures with pure lines. Its different sizes and installation options make it an ideal solution for the lighting of big spaces like lobbies, conference rooms and restaurants. Its glare control options and tunable white make it a perfect option for work zones and spaces dedicated to healthcare.

DOMIO es una familia de luminarias circulares de líneas puras. Sus diferentes tamaños y opciones de instalación la convierten en una solución ideal para la iluminación de grandes espacios como vestíbulos, salas de conferencias y restaurantes. Sus opciones con el control del deslumbramiento y tunable white hacen que sea una opción perfecta para zonas de trabajo y espacios dedicados a la salud.



DOMIO



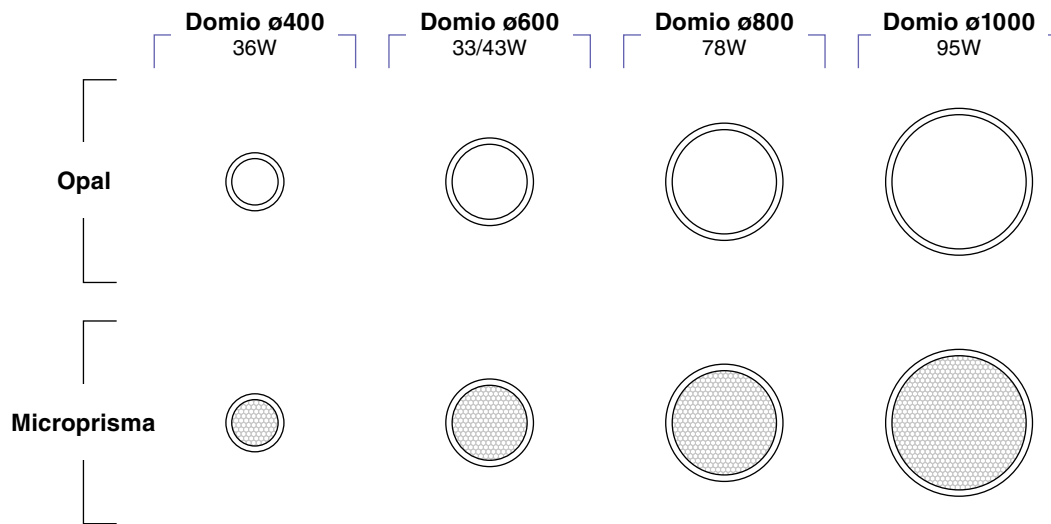

FINISH
Acabado

● **Black**
Negro

○ **White**
Blanco

COLOR TEMPERATURE
Temperatura de color

3000K

4000K

2700-6500K

ACCESSORIES
Accesorios



Suspended

CONTROL SYSTEM
Sistema de control



CASAMBI

Highlights

Available in 4 sizes of 400 mm, 600 mm, 800 mm and 1000 mm with two optics variants: opal high-transmittance PMMA to offer uniform and microprismatic general lighting for applications where glare control is required. Its UGR<19 make it an ideal option for office or continuous work applications.

Disponible en 4 tamaños de 400mm, 600mm, 800mm y 1000mm con dos variantes de ópticas: PMMA opal de alta transmitancia para ofrecer una iluminación general uniforme y micro prismática para aplicaciones donde el control de deslumbramiento es una necesidad. Su UGR<19 lo convierten en una opción ideal para aplicaciones de oficina o de trabajo en continuo.



Opal diffuser

Microprisma diffuser

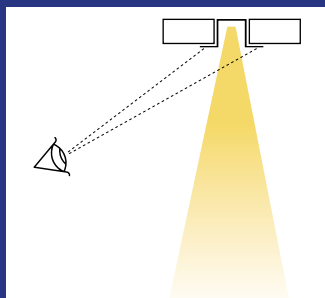

UGR<19



Different sizes
Diversos tamaños



Tunable White



Semi Recessed option
Opción semi empotrado



Wall & ceiling
Aplique y plafón



Suspended option
Opción colgante



Sala de Espera 4



Suspended

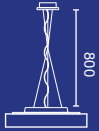

Accesorios

Suspended

● 050000097

● 050000098

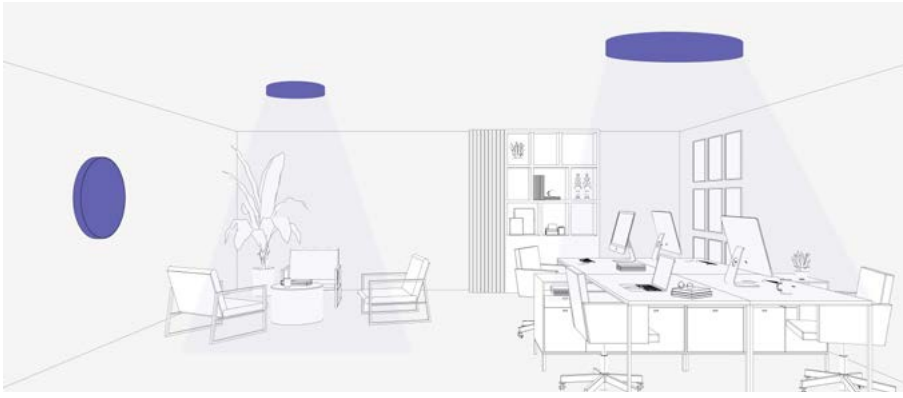

Office

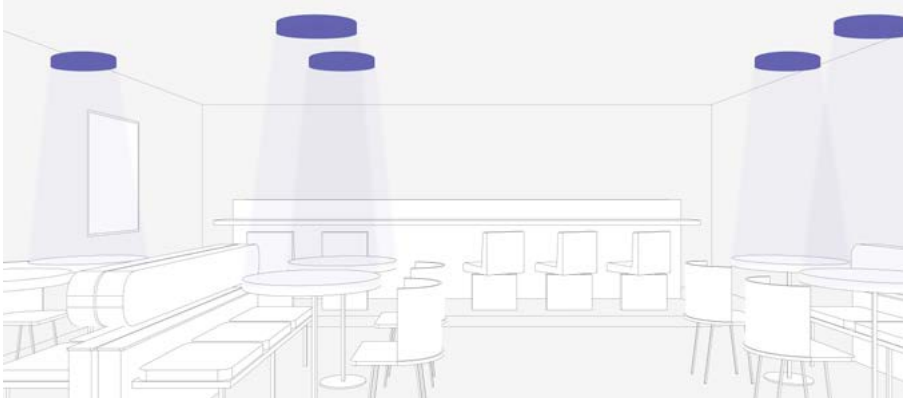

Restaurant

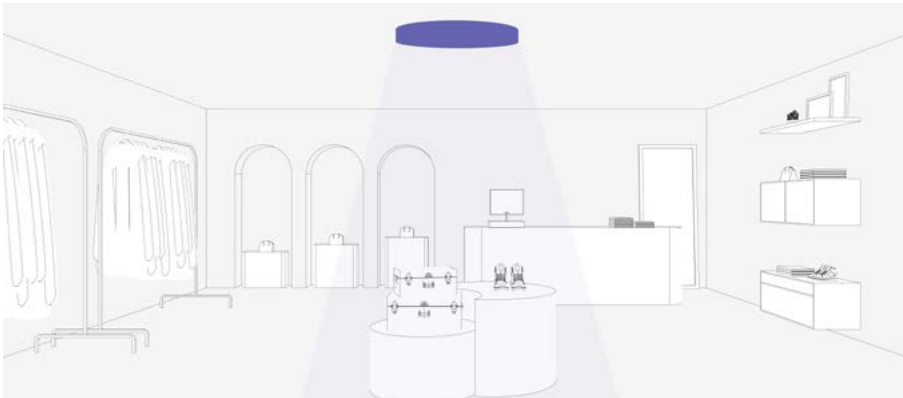

Retail

Beam Angle

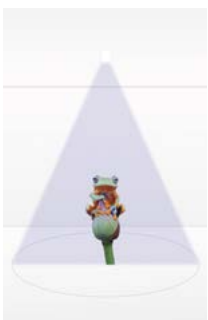

90°



110°

DOMIO ø400 36W

incl. DIM 50.000hs L80 / B10 MacAdam 3 220-240V 50 / 60Hz 650°C UGR <19

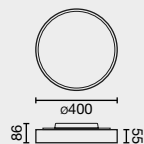
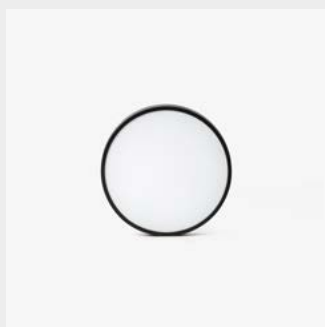

Family	Color T°	Diffuser	Finish	Control System
0414 Domio ø400 36W	830 3000K CRI80	1 Opal	1 White	W CASAMBI
	840 4000K CRI80	2 Microprisma	2 Black	D DALI ON/OFF

0414 830 1 1 W

Example **041483011W** — Domio ø400 36W 3000K Opal Diffusor White Casambi

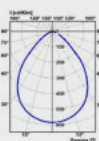

90°
microprisma

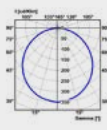

110°
opal

Option	Color T°	CRI	Power	Lumen Output	Diffuser
830	3000K	80	36W	3861lm	Opal
				3047lm	Microprisma
840	4000K	80	36W	3977lm	Opal
				3138lm	Microprisma

DOMIO ø600 43W

incl. DIM TW 50.000hs L80 / B10 MacAdam 3 220-240V 50 / 60Hz 650°C UGR <19

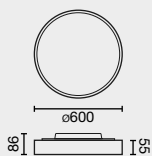
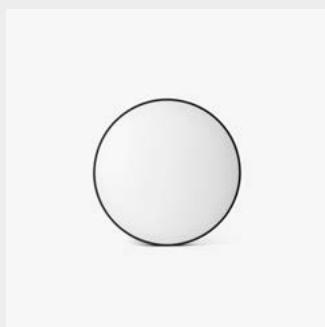

Family	Color T°	Diffuser	Finish	Control System
0415 Domio ø600 43W	830 3000K CRI80	1 Opal	1 White	W CASAMBI
	840 4000K CRI80	2 Microprisma	2 Black	D DALI ON/OFF
0419 Domio ø600 33W TW	TW 2700-6500K	1 Opal	1 White	W CASAMBI
		2 Microprisma	2 Black	D DALI

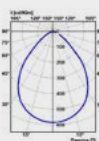

90°
microprisma

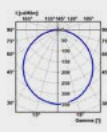

110°
opal

Option	Color T°	CRI	Power	Lumen Output	Diffuser
830	3000K	80	43W	4725lm	Opal
				4059lm	Microprisma
840	4000K	80	43W	4867lm	Opal
				4181lm	Microprisma

DOMIO ø600 TW

TW	2700-6500K	-	33W	3528lm	Opal
TW	2700-6500K	-	33W	3031lm	Microprisma





DOMIO ø800 78W

incl. DIM 50.000hs L80 / B10 MacAdam 3 220-240V 50 / 60Hz 650°C UGR <19

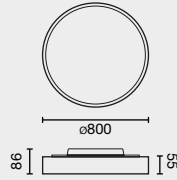
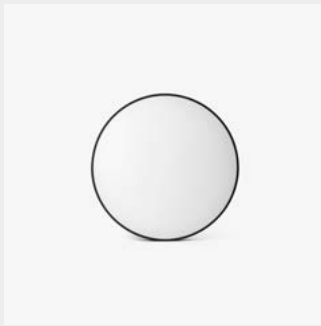

Family	Color T°	Diffuser	Finish	Control System
0416 Domio ø800 78W	830 3000K CRI80 840 4000K CRI80	1 Opal 2 Microprisma	1 White 2 Black	W CASAMBI D DALI ON/OFF

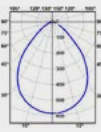

90°
microprisma

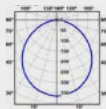

110°
opal

Option	Color T°	CRI	Power	Lumen Output	Diffuser
830	3000K	80	78W	8174lm	Opal
				7022lm	Microprisma
840	4000K	80	78W	8419lm	Opal
				7232lm	Microprisma

DOMIO ø1000 95W

incl. DIM 50.000hs L80 / B10 MacAdam 3 220-240V 50 / 60Hz 650°C UGR <19

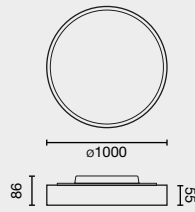

Family	Color T°	Diffuser	Finish	Control System
0417 Domio ø1000 95W	830 3000K CRI80 840 4000K CRI80	1 Opal 2 Microprisma	1 White 2 Black	W CASAMBI D DALI ON/OFF

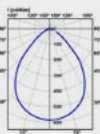

90°
microprisma

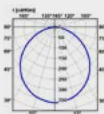

110°
opal

Option	Color T°	CRI	Power	Lumen Output	Diffuser
830	3000K	80	95W	10490lm	Opal
				9010lm	Microprisma
840	4000K	80	95W	10804lm	Opal
				9281lm	Microprisma

PODIUM is a modular system of recessed and surface light fixtures which offers different light effects and configurations, enabling the creation of different climates with an integrated aesthetic. One product, one project, infinite possibilities.

PODIUM es un sistema modular de luminarias de empotrar y de superficie que ofrece diferentes efectos lumínicos y configuraciones permitiendo generar diversos climas con una estética integrada. Un producto, un proyecto, infinitas posibilidades.



S U R F A C E



PODIUM



PODIUM Collection



Downlight
259

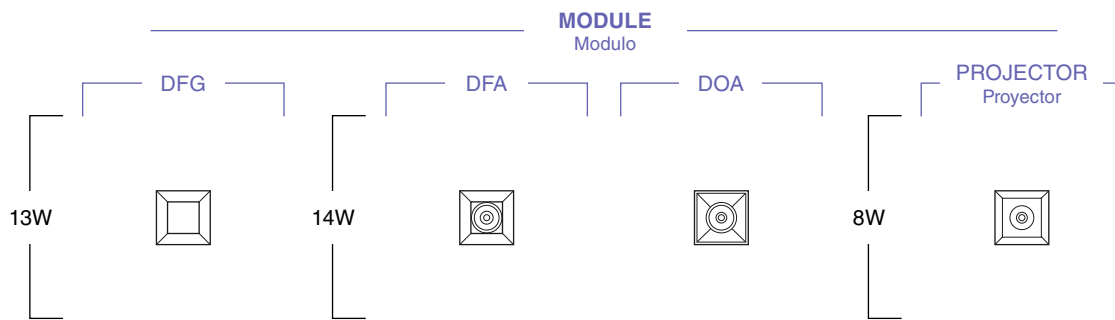

SURFACE BOX
Caja de superficie

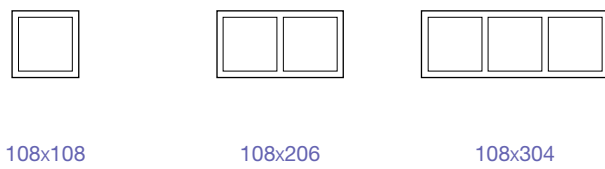

FINISH
Acabado

- Black**
Negro
- White**
Blanco

COLOR TEMPERATURE
Temperatura de color

- 2700K CRI97
- 3000K CRI97
- 4000K CRI97
- 2700K CRI90
- 3000K CRI90
- 4000K CRI90

BEAM ANGLE
Ángulo de apertura



ACCESSORIES
Accesorios

- Honeycomb
- Striped glass
- Diffusion sheet

CONTROL SYSTEM
Sistema de control

-
-
-

Highlights

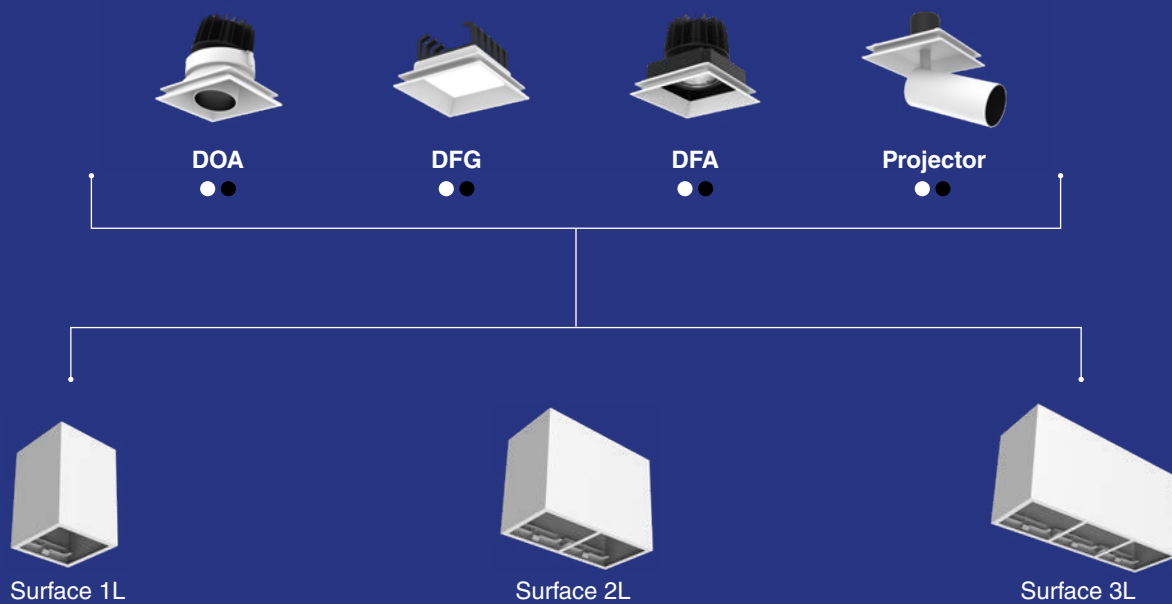





Surface box 1L

Surface box 2L

Surface box 3L

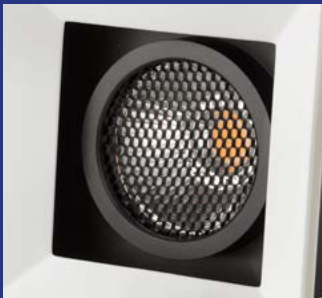
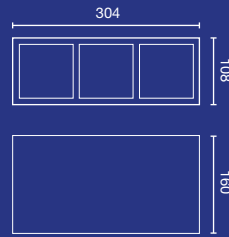
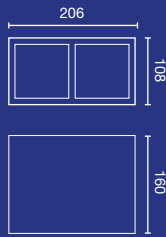
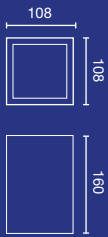

Honeycomb



Stripped Glass



Diffusion Sheet

Surface box

Accessories for DFA&DOA

Surface box 1L	Surface box 2L	Surface box 3L
● 051300011	● 051400021	● 051500031
● 051300012	● 051400022	● 051500032

Honeycomb	Stripped Glass	Diffusion sheet
034100098	034100097	034100099



Residential



Restaurant

Beam Angle



18°

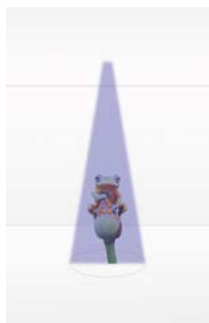

24/25°

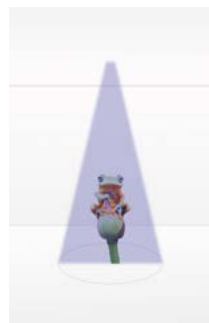

35/38°



60°



90°



110°

PODIUM DFA MODULE

incl. DIM 50.000hs L70 / B10 MacAdam 3 220-240V 50 / 60Hz 650°C



Family	Color T°	Beam Angle	Finish	Control System
0341 Podium DFA Module 15W	927 2700K CRI97	1 15°	1 White	W CASAMBI
	930 3000K CRI97	2 24°	2 Black	D DALI
	940 4000K CRI97	3 38°		C TRIAC
		6 60°		ON/OFF

0341 927 1 1 W

Example 034192711W — Podium DFA Module 15W 2700K CRI97 15° White Casambi

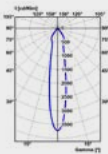

15°

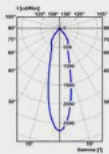

24°

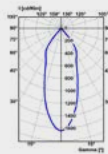

38°

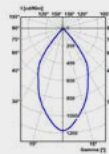

60°

Option	Color T°	CRI	Power	Lumen Output	Beam Angle
X27	2700K	97	15W	1121lm / 1026lm / 1036lm / 1060lm	15° / 24° / 38° / 60°
X30	3000K	97	15W	1156lm / 1058lm / 1068lm / 1093lm	15° / 24° / 38° / 60°
X40	4000K	97	15W	1191lm / 1090lm / 1100lm / 1126lm	15° / 24° / 38° / 60°

See surface box options on page 360
Ver opciones de caja en página 360

PODIUM DOA MODULE

incl. DIM 355° 20° 50.000hs L70 / B10 MacAdam 3 220-240V 50 / 60Hz 650°C



Family	Color T°	Beam Angle	Finish	Control System
0342 Podium DOA Module 15W	927 2700K CRI97	1 15°	1 White	W CASAMBI
	930 3000K CRI97	2 24°	2 Black	D DALI
	940 4000K CRI97	3 38°		C TRIAC
		6 60°		ON/OFF

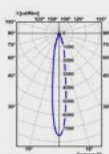

15°

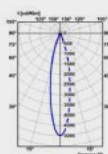

24°

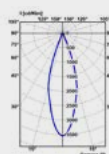

38°

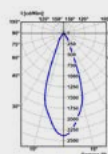

60°

Option	Color T°	CRI	Power	Lumen Output	Beam Angle
X27	2700K	97	15W	435lm / 439lm / 448lm / 456lm	15° / 24° / 38° / 60°
X30	3000K	97	15W	448lm / 453lm / 462lm / 470lm	15° / 24° / 38° / 60°
X40	4000K	97	15W	461lm / 467lm / 476lm / 484lm	15° / 24° / 38° / 60°

See surface box options on page 360
Ver opciones de caja en página 360

PODIUM DFG MODULE

incl. DIM 50.000hs L70 / B10 MacAdam 3 220-240V 50 / 60Hz 650°C

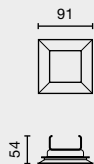

Family	Color T°	Beam Angle	Finish	Control System								
0343 Podium DFG Module 13W	927 2700K CRI90	0 110°	1 White	<table border="1"> <tr><td>W</td><td>CASAMBI</td></tr> <tr><td>D</td><td>DALI</td></tr> <tr><td>C</td><td>TRIAC</td></tr> <tr><td></td><td>ON/OFF</td></tr> </table>	W	CASAMBI	D	DALI	C	TRIAC		ON/OFF
	W		CASAMBI									
	D		DALI									
C	TRIAC											
	ON/OFF											
930 3000K CRI90	2 Black											
940 4000K CRI90												

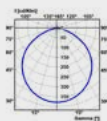

110°

Option	Color T°	CRI	Power	Lumen Output	Beam Angle
927	2700K	90	13W	648lm	110°
930	3000K	90	13W	668lm	110°
940	4000K	90	13W	688lm	110°

See surface box options on page 360
Ver opciones de caja en página 360

PODIUM PROJECTOR MODULE

incl. DIM 355° 90° 50.000hs L70 / B10 MacAdam 3 220-240V 50 / 60Hz 650°C

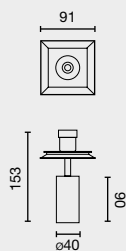

Family	Color T°	Beam Angle	Finish	Control System
0345 Podium Projector Module 8W	927 2700K CRI97	1 15°	1 White	W CASAMBI
	930 3000K CRI97	2 25°	2 Black	D DALI
	940 4000K CRI97			C TRIAC ON/OFF

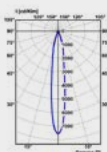

15°

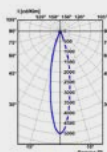

25°

Option	Color T°	CRI	Power	Lumen Output	Beam Angle
X27	2700K	97	8W	273lm / 273lm	15° / 25°
X30	3000K	97	8W	281lm / 281lm	15° / 25°
X40	4000K	97	8W	289lm / 289lm	15° / 25°

See surface box options on page 360
Ver opciones de caja en página 360

S U S P E

E N D E D

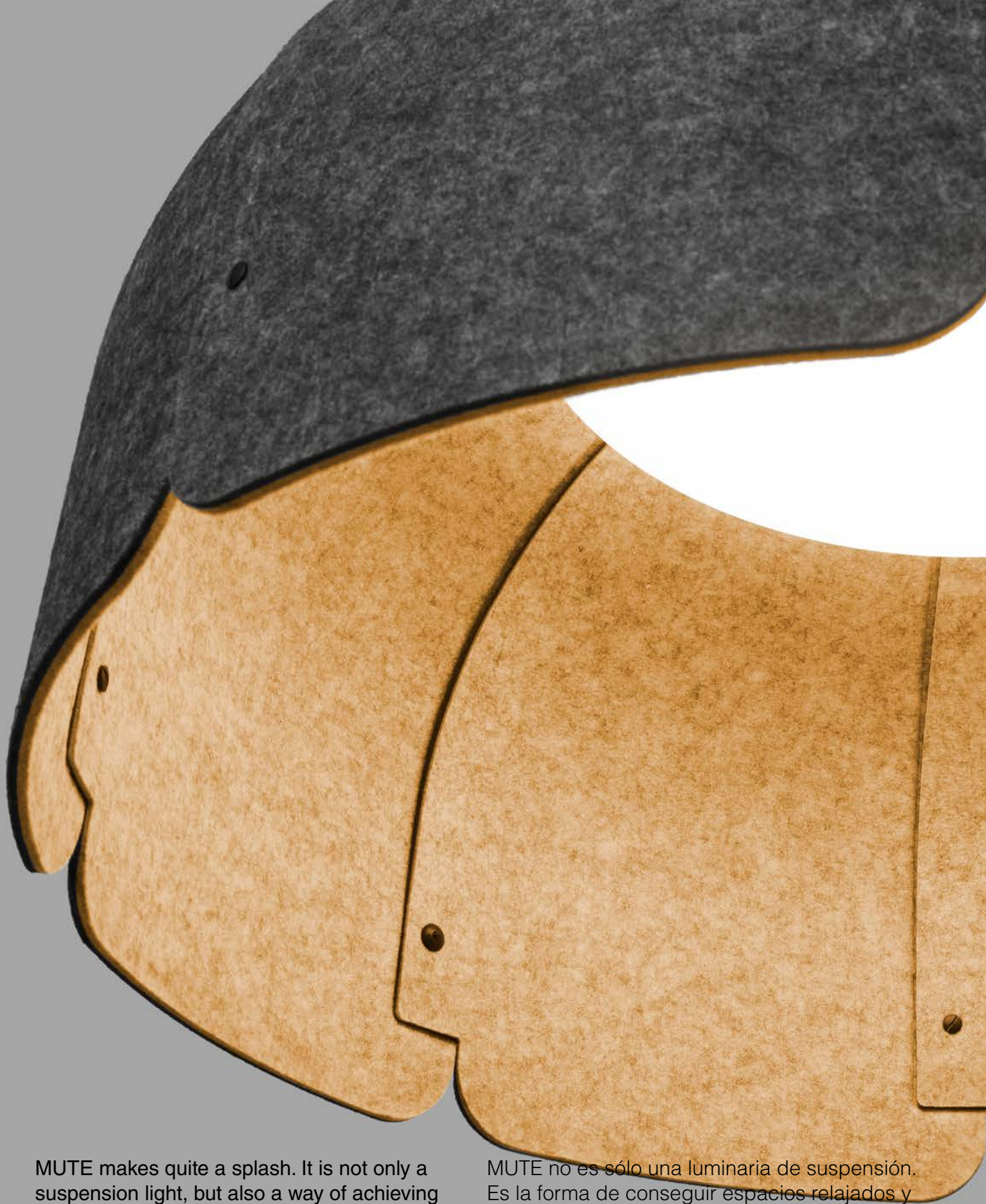

MUTE makes quite a splash. It is not only a suspension light, but also a way of achieving relaxed spaces and inviting communication. Its textile fabric absorbs reverberation and contributes to the reduction of environmental noise.

MUTE no es sólo una luminaria de suspensión. Es la forma de conseguir espacios relajados y que inviten a la comunicación. Su tejido textil absorbe la reverberación y contribuye a la reducción del ruido ambiental.



MUTE

DESIGNED BY NAHTRANG



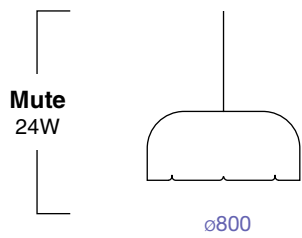

FINISH
Acabado

- **Dark Grey+Grey**
Gris oscuro+Gris
- **Dark Grey+Brown**
Gris oscuro+Marrón

COLOR TEMPERATURE
Temperatura de color

3000K CRI>80

4000K CRI>80

CONTROL SYSTEM
Sistema de control



Highlights



Recycled PET

Because polyester accounts for approximately 60 percent of the world's production of PET, developing a non-virgin supply chain for polyester fiber has the potential to massively impact global energy and resource requirements.

Debido a que el poliéster representa aproximadamente el 60 por ciento de la producción mundial de PET, el desarrollo de una cadena de suministro no virgen para la fibra de poliéster tiene el potencial de impactar masivamente los requerimientos globales de energía y recursos.

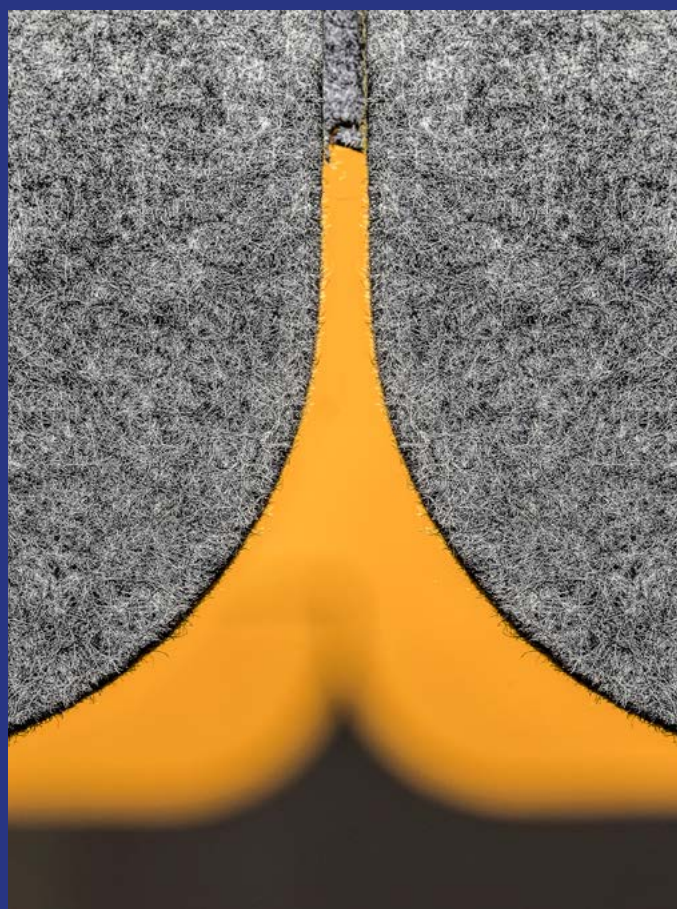

Sound Absorbing $\alpha = 0.9$

Noise in offices and workplaces has direct consequences on worker performance. The most immediate one is the reduction of their concentration. Workers exposed to continuous noise in their workplace are less effective in their work tasks. Concentration often means giving the brain a break to think better and focus on an activity. Luminaires made from fabrics with noise-absorbing properties are perfect for work spaces with high noise levels and acoustic distractions.

El ruido en las oficinas y lugares de trabajo tiene consecuencias directas en el rendimiento de los trabajadores. La más inmediata es la reducción de su concentración. Los trabajadores expuestos a un ruido continuo en su lugar de trabajo son menos eficaces en sus tareas. La concentración suele significar dar un respiro al cerebro para pensar mejor y centrarse en una actividad. Las luminarias fabricadas con tejidos con propiedades de absorción del ruido son perfectas para espacios de trabajo con altos niveles de ruido y distracciones acústicas.





Restaurant



Office

Beam Angle

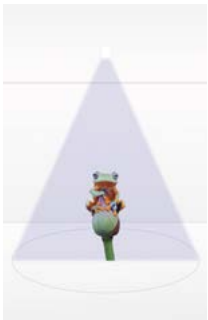

90°





BEDEO relational/project

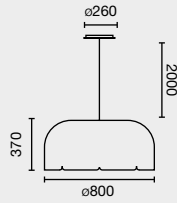

MUTE ø80 24W

incl. DIM 50.000hs L70 / B10 MacAdam 3 100-240V 50 / 60Hz 850°C UGR <19



Reference	Finish	Power	Color T°	Control System
20101	Dark grey+grey	24W	3000K CRI>80	DA 
20102	Dark grey+brown	24W	3000K CRI>80	ON/OFF
20103	Dark grey+grey	24W	4000K CRI>80	
20104	Dark grey+brown	24W	4000K CRI>80	

20101

DA

Example **20101DA** — Mute ø80 24W 3000K CRI>80 Dark Grey+grey Dali

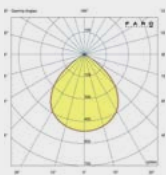

90°

Option	Color T°	CRI	Power	Lumen Output	Beam Angle
20101	3000K	>80	24W	1014lm	90°
20102	3000K	>80	24W	1014lm	90°
20103	4000K	>80	24W	1044lm	90°
20104	4000K	>80	24W	1044lm	90°



FOST PENDANT is a tubular shaped suspended light fixture with a proportion designed to be part of the architecture by providing an aesthetic value and accentuating what needs to be highlighted. Its technical and decorative character, and its multiple options of size, optics, colour temperatures and CRI make it an ideal option for architectural spaces like restaurants, hotels and other spaces where it is necessary to combine aesthetic values and technical lighting.

FOST PENDANT es una luminaria suspendida de forma tubular con una proporción diseñada para formar parte de la arquitectura aportando un valor estético y acentuando lo que debe ser destacado. Su carácter técnico-decorativo y sus múltiples opciones tanto en tamaños, ópticas, temperaturas de color y IRC, lo convierten en una opción ideal para espacios arquitectónicos como restaurantes, hoteles y otros espacios donde es necesario conjugar valores estéticos e iluminación técnica.

F O S T



P E N D A N T



FOST Collection



Track
39



Recessed
227



Pulldown
237



Ceiling
331



Surface
321

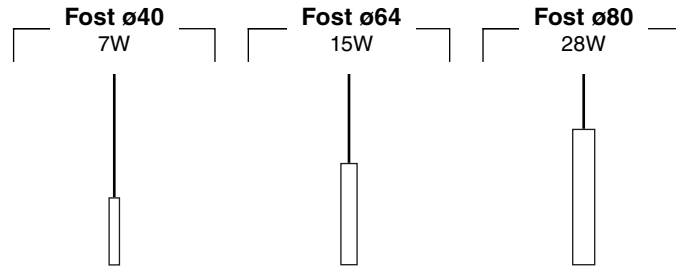

FINISH
Acabado

● **Black**
Negro

○ **White**
Blanco

COLOR TEMPERATURE
Temperatura de color

2700K CRI90	3000K CRI90	4000K CRI90
2700K CRI97	3000K CRI97	4000K CRI97
MEAT	BREAD	FASHION

BEAM ANGLE
Ángulo de apertura

17° / 18°	23° / 25°	35° / 38°
-----------	-----------	-----------

ACCESSORIES
Accesorios

Honeycomb

White Ring

Copper Ring

CONTROL SYSTEM
Sistema de control





White Ring



Copper Ring



Honeycomb

Its multiple accessories and combinations facilitate the product's personalisation, giving it certain architectural relevance and at the same time making it possible to modify the beam or reduce glare.

Sus múltiples accesorios y combinaciones facilitan la personalización del producto que hace posible la modificación de haz o reducir el deslumbramiento.

Accesorios

	Honeycomb	White Ring	Copper Ring
ø40	-	011500099	011500098
ø64	011700094	011700099	011700098
ø80	011300097	011300099	011300098



Restaurant

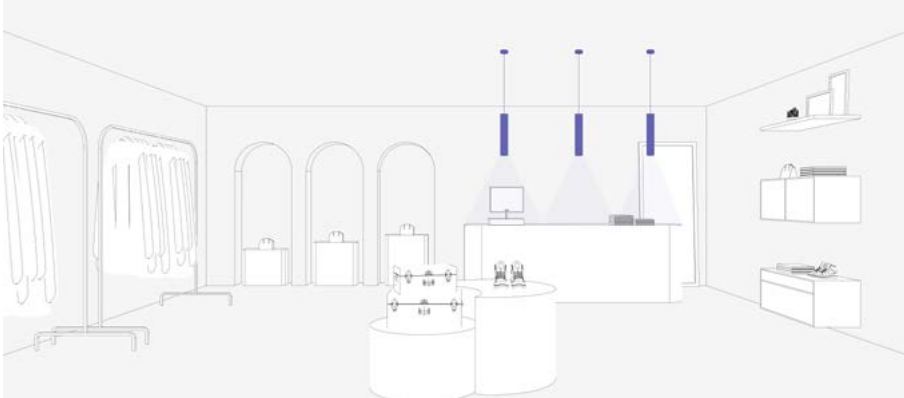

Retail

Beam Angle

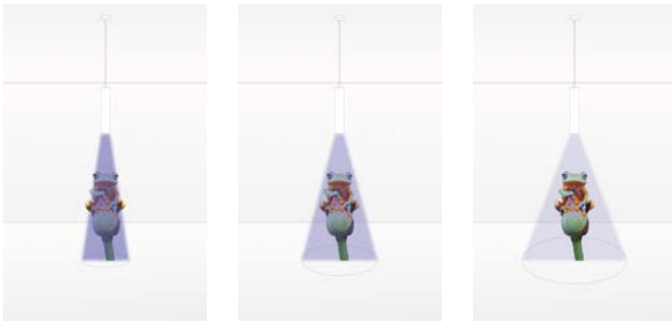

17/18°

23/25°

35/38°



EMMME Studio | Photo by Lupe Clemente



FOST PENDANT ø40

incl. 50.000hs L80 / B10 MacAdam 2 & 3 220-240V 50 / 60Hz 650°C



Family	Color T°	Beam Angle	Finish	Control System
0411 Fost Pendant ø40 7W	927 2700K CRI90	1 18°	1 White	ON/OFF
	930 3000K CRI90	2 23°	2 Black	D DALI
	940 4000K CRI90	3 35°		
	X27 2700K CRI97			
	X30 3000K CRI97			
	X40 4000K CRI97			

0411 927 1 1

Example 041192711 — Fost Pendant ø40 7W 2700K CRI90 18° White

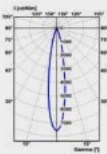

18°

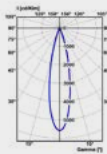

23°

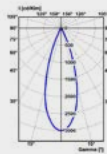

35°

Option	Color T°	CRI	Power	Lumen Output	Beam Angle
927	2700K	90	7W	632lm / 553lm / 586lm	18° / 23° / 35°
X27		97	7W	569lm / 498lm / 527lm	18° / 23° / 35°
930	3000K	90	7W	652lm / 570lm / 604lm	18° / 23° / 35°
X30		97	7W	587lm / 513lm / 544lm	18° / 23° / 35°
940	4000K	90	7W	652lm / 587lm / 622lm	18° / 23° / 35°
X40		97	7W	587lm / 528lm / 560lm	18° / 23° / 35°

FOST PENDANT ø64

incl. DIM 50.000hs L80 / B10 MacAdam 2 & 3 220-240V 50 / 60Hz 650°C

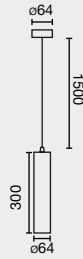

Family	Color T°	Beam Angle	Finish	Control System
0412 Fost Pendant ø64 14W	927 2700K CRI90	1 17°	1 White	C ON/OFF D DALI
	930 3000K CRI90	2 25°	2 Black	
	940 4000K CRI90	3 35°		
	X27 2700K CRI97			
	X30 3000K CRI97			
	X40 4000K CRI97			

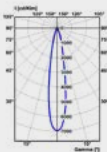

17°

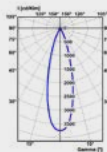

25°

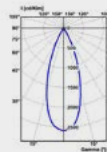

35°

Option	Color T°	CRI	Power	Lumen Output	Beam Angle
927	2700K	90	14W	1372lm / 1553lm / 1503lm	17° / 25° / 35°
X27		97	14W	1235lm / 1398lm / 1352lm	17° / 25° / 35°
930	3000K	90	14W	1414lm / 1601lm / 1549lm	17° / 25° / 35°
X30		97	14W	1273lm / 1441lm / 1394lm	17° / 25° / 35°
940	4000K	90	14W	1457lm / 1650lm / 1596lm	17° / 25° / 35°
X40		97	14W	1311lm / 1484lm / 1436lm	17° / 25° / 35°

FOST PENDANT ø80

incl. DIM 50.000hs L80 / B10 MacAdam 2 & 3 220-240V 50 / 60Hz 650°C

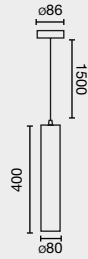

Family	Color T°	Beam Angle	Finish	Control System
0413 Fost Pendant ø80 28W	927 2700K CRI90	1 18° 2 23° 3 38°	1 White	D DALI C TRIAC ON/OFF
	930 3000K CRI90		2 Black	
	940 4000K CRI90			
	X27 2700K CRI97			
	X30 3000K CRI97			
	X40 4000K CRI97			

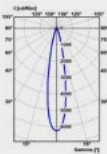

18°

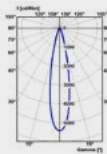

23°

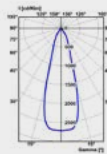

38°

Option	Color T°	CRI	Power	Lumen Output	Beam Angle
927	2700K	90	28W	1684lm / 1772lm / 1334lm	18° / 23° / 38°
X27		97	28W	1515lm / 1595lm / 1200lm	
930	3000K	90	28W	1736lm / 1827lm / 1375lm	
X30		97	28W	1562lm / 1644lm / 1237m	
940	4000K	90	28W	1788lm / 1882lm / 1416lm	18° / 23° / 38°
X40		97	28W	1609lm / 1693lm / 1274lm	



S Y S T

E M S

NEW 3D CONFIGURATOR

NESO



NESO, a magnetic track system, seamlessly integrates various luminaires, ranging from general lights to striking accents. Its modular and magnetic design not only provides flexibility but also transforms environments with its exceptional adaptability and design. Ideal for commercial settings, NESO offers projectors with up to 20W, whereas NESO Slim, tailored for residential spaces, brings elegance and an endless array of options to craft truly unique atmospheres.

NESO, un sistema de carril magnético, fusiona distintas luminarias, abarcando desde luces generales hasta resaltantes acentos. Su diseño modular y magnético no solo brinda flexibilidad, sino que también transforma entornos con su adaptabilidad y diseño excepcional. Perfecto para entornos comerciales, NESO ofrece proyectores de hasta 20W, mientras que NESO Slim, diseñado para espacios residenciales, aporta elegancia y una variedad ilimitada de opciones para crear ambientes verdaderamente únicos.



THE MAGNETIC TRACK SYSTEM

NESO



Highlights

Neso Slim



Super Slim design
Diseño Super Delgado



Maximum integration of luminaires on rail
Integración máxima de las luminarias en carril

Neso Slim and Standard



Magnetic
Magnético



Versatility
Versatilidad

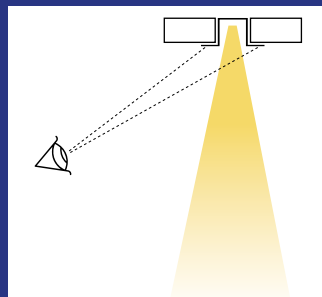

UGR<16 Option



Connectivity
Conectividad



NESO



TRACKS
Carriles

RECESSED
Empotrable

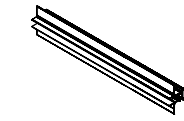

1000 | 2000

SURFACE
Superficie

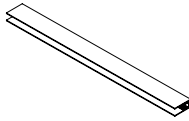

1000 | 2000

PENDANT
Colgante

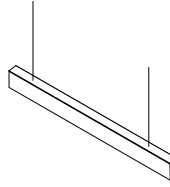

1000 | 2000

MODULES
Módulos

Neso
Point



84



164



320

Neso
Unik



ø150

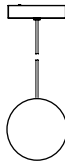

ø150

Neso
Line

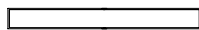

320

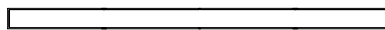

640

Neso
Hole

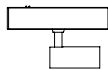

ø35

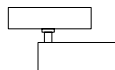

ø50

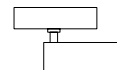

ø70

Neso
Top



ø35

FINISH
Acabado

● **Black**
Negro

○ **White**
Blanco

COLOR TEMPERATURE
Temperatura de color

2700K CRI>90

3000K CRI>90

CONTROL SYSTEM
Sistema de Control



CASAMBI



Détail Studio | Photo by Julien Chamoux Photographie



TRACK RECESSED

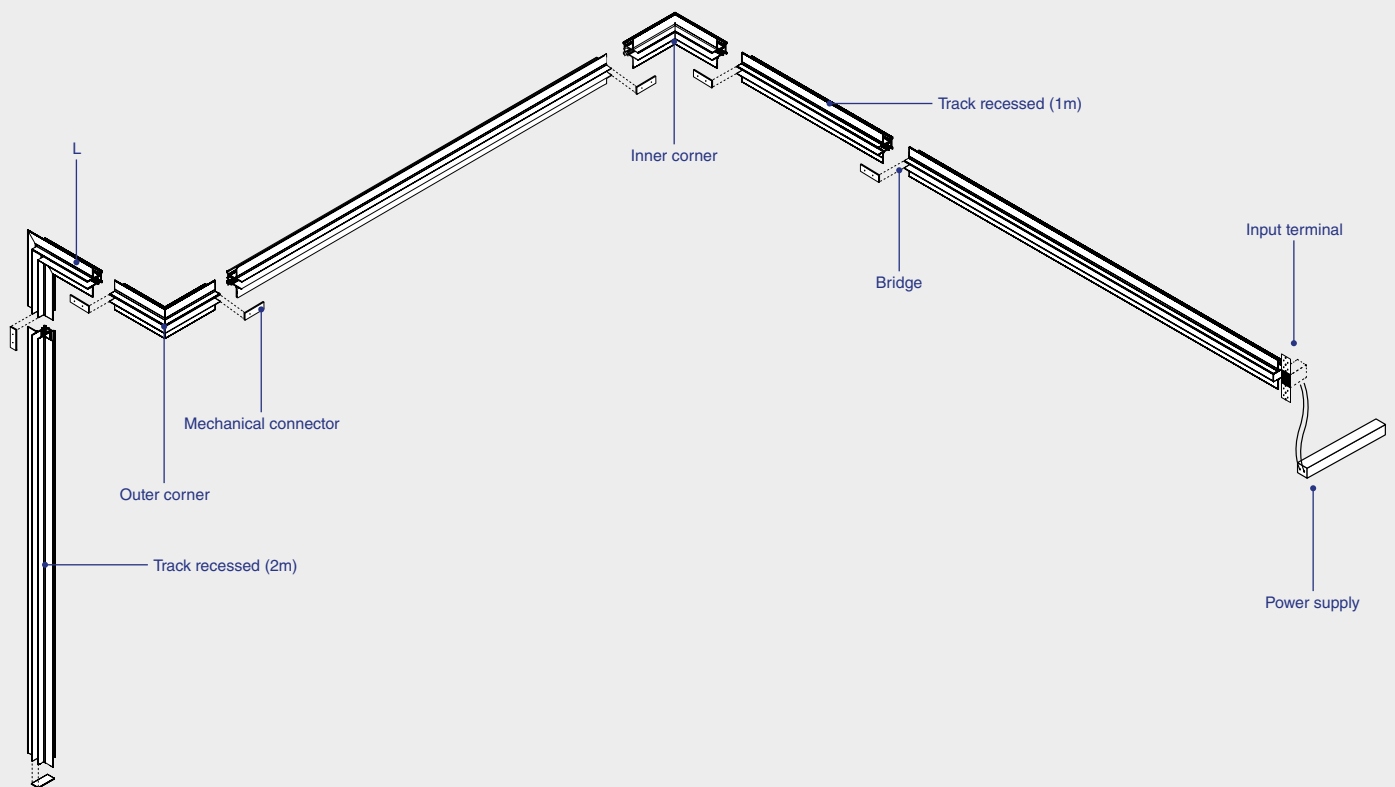

24V

Family	Track Length	Finish	Control System
5020120 Neso Track Recessed	10 1m	1 White	D  ON/OFF
	20 2m	2 Black	

ACCESSORIES NESO

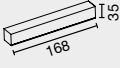
	● 5020200102 Mechanical connector
	● 5020115101 / ● 5020115102 Bridge
	● 5020115101D / ● 5020115102D Bridge DALI
● 5020R120102	Track cover
	● 5020R120101 Track cover
POWER SUPPLY	
98324120	Power supply 120W
98324150	Power supply 150W
98324180	Power supply 180W
98324200	Power supply 200W

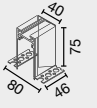
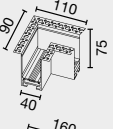
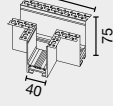
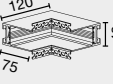
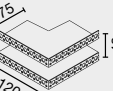
	● 5020221401 / ● 5020221402 Input terminal
	● 5020221401D / ● 5020221402D Input terminal DALI
	● 5020221001 / ● 5020221002 L
	● 5020221001D / ● 5020221002D L DALI
	● 5020221101 / ● 5020221102 T
	● 5020221101D / ● 5020221102D T DALI
	● 5020221201 / ● 5020221202 Inner corner
	● 5020221201D / ● 5020221202D Inner corner DALI
	● 5020221301 / ● 5020221302 Outer corner
	● 5020221301D / ● 5020221302D Outer corner DALI

TRACK SURFACE & SUSPENSION

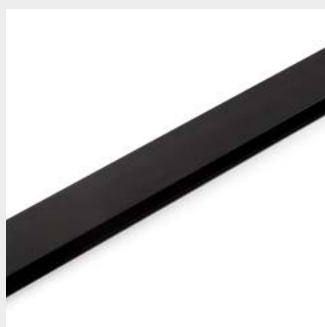
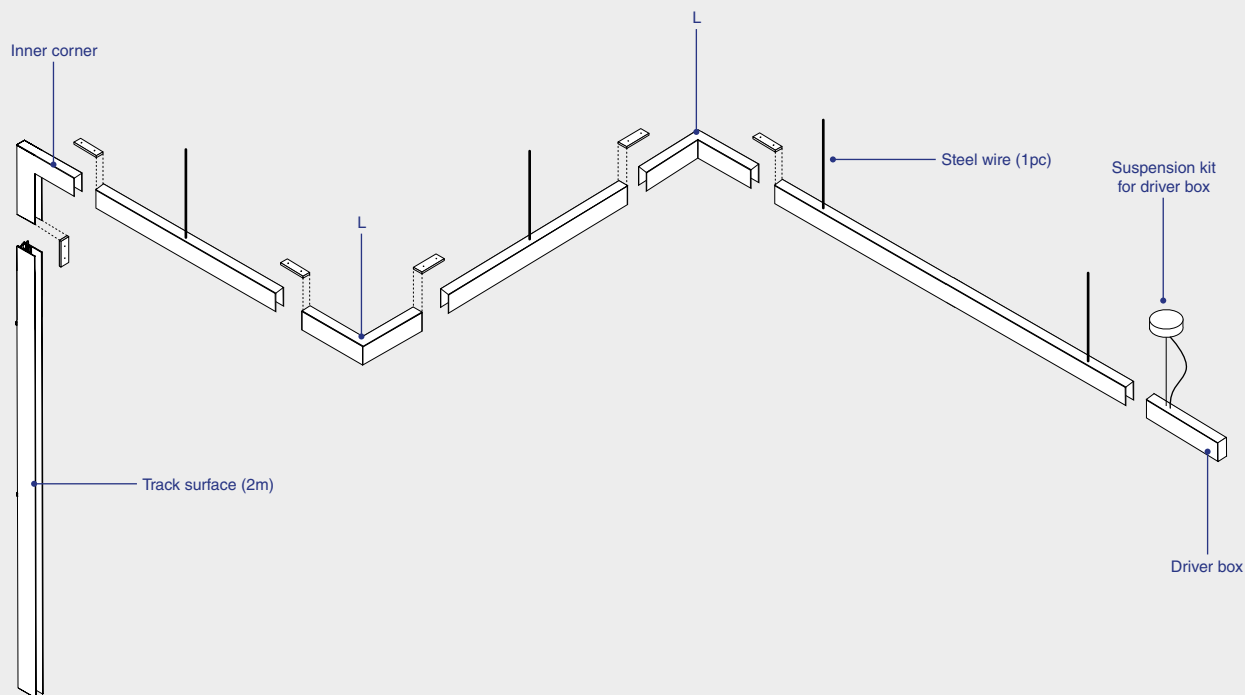

24V

Family	Track Length	Finish	Control System
5020110 Neso Track Surface	10 1m	1 White	D ON/OFF
	20 2m	2 Black	

ACCESSORIES NESO

	● 5020200102 Mechanical connector
	● 5020115101 / ● 5020115102 Bridge
	● 5020115101D / ● 5020115102D Bridge DALI
	● 5020210001 / ● 5020210002 Driver box
	● 5020210001D / ● 5020210002D Driver box DALI
	● 5020210201 / ● 5020210202 Suspension kit
	● 5020210201D / ● 5020210202D Suspension kit DALI
	5020210102 Steel wire
	● 5020R120102 Track cover
	● 5020R120101 Track cover
POWER SUPPLY	
	98324120 Power supply 120W
	98324150 Power supply 150W
	98324180 Power supply 180W
	98324200 Power supply 200W

	● 5020210301 / ● 5020210302 Input terminal
	● 5020210301D / ● 5020210302D Input terminal DALI
	● 5020211001 / ● 5020211002 L
	● 5020211001D / ● 5020211002D L DALI
	● 5020211101 / ● 5020211102 T
	● 5020211101D / ● 5020211102D T DALI
	● 5020211201 / ● 5020211202 Inner corner
	● 5020211201D / ● 5020211202D Inner corner DALI
	● 5020211301 / ● 5020211302 Outer corner
	● 5020211301D / ● 5020211302D Outer corner DALI





NESO POINT 3L

no incl. 50.000hs L70/B10 MacAdam 3 24V 650°C UGR <16

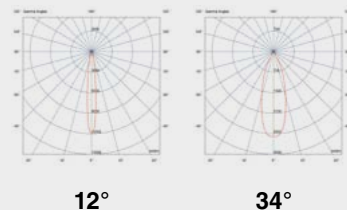
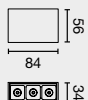

Family	Color T°	Beam Angle	Finish
50101 Point 3L 4W	927 2700K 217lm CRI>90	1 12°	1 White
	930 3000K 292lm CRI>90	2 34°	2 Black

NESO POINT 6L

no incl. 50.000hs L70/B10 MacAdam 3 24V 650°C UGR <16

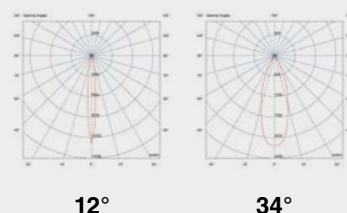
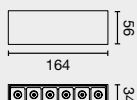

Family	Color T°	Beam Angle	Finish	Control System
50102 Point 6L 8W	927 2700K 480lm CRI>90	1 12°	1 White	W CASAMBI
	930 3000K 506lm CRI>90	2 34°	2 Black	D DALI
				ON/OFF

NESO POINT 12L

no incl. 50.000hs L70/B10 MacAdam 3 24V 650°C UGR <16

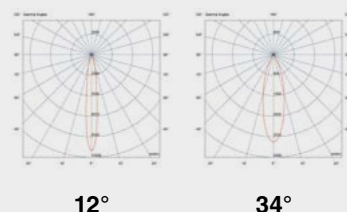
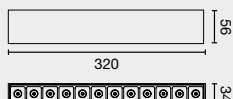

Family	Color T°	Beam Angle	Finish	Control System
50103 Point 12L 16W	927 2700K 1102lm CRI>90	1 12°	1 White	W CASAMBI
	930 3000K 1107lm CRI>90	2 34°	2 Black	D DALI
				ON/OFF



NESO LINE 32cm

no incl. 50.000hs L70/B10   MacAdam 3 24V  650°C

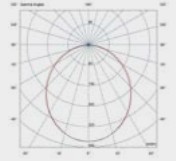
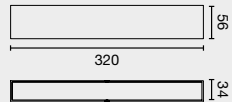

32

Family

Color T°

Finish

Control System

50104 Line 32cm 13W

927 2700K 892lm CRI>90

01 White

W CASAMBI

930 3000K 920lm CRI>90

02 Black

D DALI

ON/OFF

NESO LINE 64cm

no incl. 50.000hs L70/B10   MacAdam 3 24V  650°C

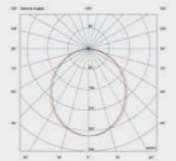
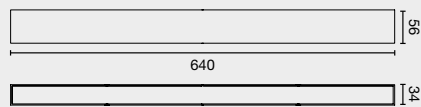

64

Family

Color T°

Finish

Control System

50105 Line 64cm 26W

927 2700K 1399lm CRI>90

01 White

W CASAMBI

930 3000K 1442lm CRI>90

02 Black

D DALI

ON/OFF



NESO HOLE ø3.5cm

no incl. 50.000hs L70/B10 MacAdam 3 24V 650°C

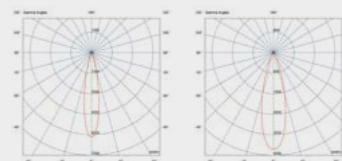
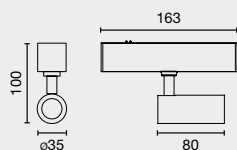

20°

40°

Family

Color T°

Beam Angle

Finish

Control System

50107 Hole ø3,5cm 5W

927 2700K 360lm CRI>90

930 3000K 444lm CRI>90

1 20°

2 40°

1 White

2 Black

W CASAMBI

D DALI

ON/OFF

NESO HOLE ø5cm

no incl. 50.000hs L70/B10 MacAdam 3 24V 650°C

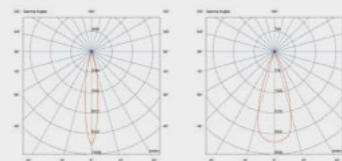
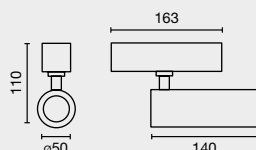

18°

36°

Family

Color T°

Beam Angle

Finish

Control System

50108 Hole ø5cm 10W

027 2700K 445lm CRI>90

030 3000K 592lm CRI>90

1 18°

2 36°

1 White

2 Black

W CASAMBI

D DALI

ON/OFF

NESO HOLE ø7cm

no incl. 50.000hs L70/B10 MacAdam 3 24V 650°C

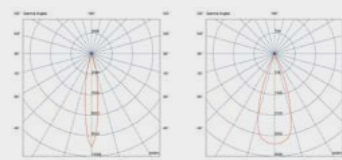
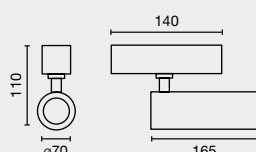

18°

36°

Family

Color T°

Beam Angle

Finish

Control System

50110 Hole ø7cm 20W

027 2700K 881lm CRI90

030 3000K 1171lm CRI90

1 18°

2 36°

1 White

2 Black

W CASAMBI

D DALI

ON/OFF



NESO UNIK

no incl. 50.000hs L70/B10 MacAdam 3 24V 650°C

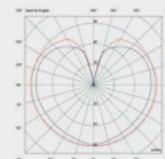
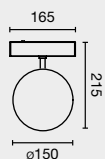

325°

Family

Color T°

Finish

Control System

50108 Unik 5W

927 2700K 256lm CRI>90

01 White

W CASAMBI

930 3000K 264lm CRI>90

02 Black

D DALI

ON/OFF

NESO UNIK

no incl. 50.000hs L70/B10 MacAdam 3 24V 650°C

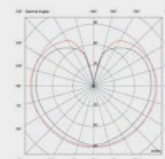
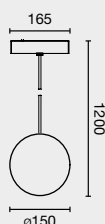

325°

Family

Color T°

Finish

Control System

50109 Unik 5W

027 2700K 256lm CRI>90

01 White

W CASAMBI

030 3000K 264lm CRI>90

02 Black

D DALI

ON/OFF

NESO TOP

no incl. 50.000hs L70/B10 MacAdam 3 24V 650°C

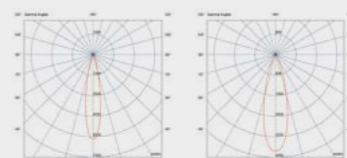
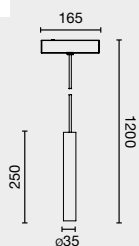

20°

40°

Family

Color T°

Beam Angle

Finish

Control System

50106 Top 5W

927 2700K 360m CRI>90

1 20°

1 White

W CASAMBI

930 3000K 444lm CRI>90

2 40°

2 Black

D DALI

ON/OFF







NESO SLIM



TRACKS
Carriles

RECESSED
Empotrable

SURFACE
Superficie

PENDANT
Colgante

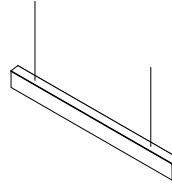
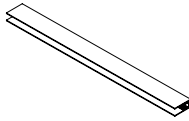

1000 | 2000

1000 | 2000

1000 | 2000

MODULES
Módulos

Neso Slim
Point



305

388

Neso Slim
Unik



ø150

Neso Slim
Line/Wallwasher

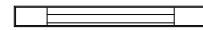
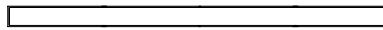
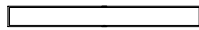

N

305

704

305

Neso Slim
Hole

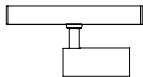

ø35

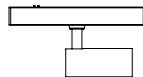

ø50

Neso Slim
Pendants

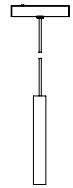

ø35

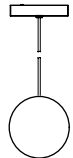

ø150



ø32



ø40



ø72

FINISH
Acabado

● **Black**
Negro

COLOR TEMPERATURE
Temperatura de color

2700K CRI>90

3000K CRI>90

CONTROL SYSTEM
Sistema de Control



CASAMBI

TRACK RECESSED

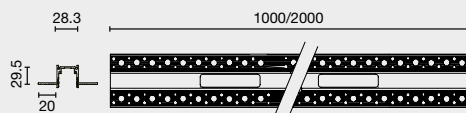
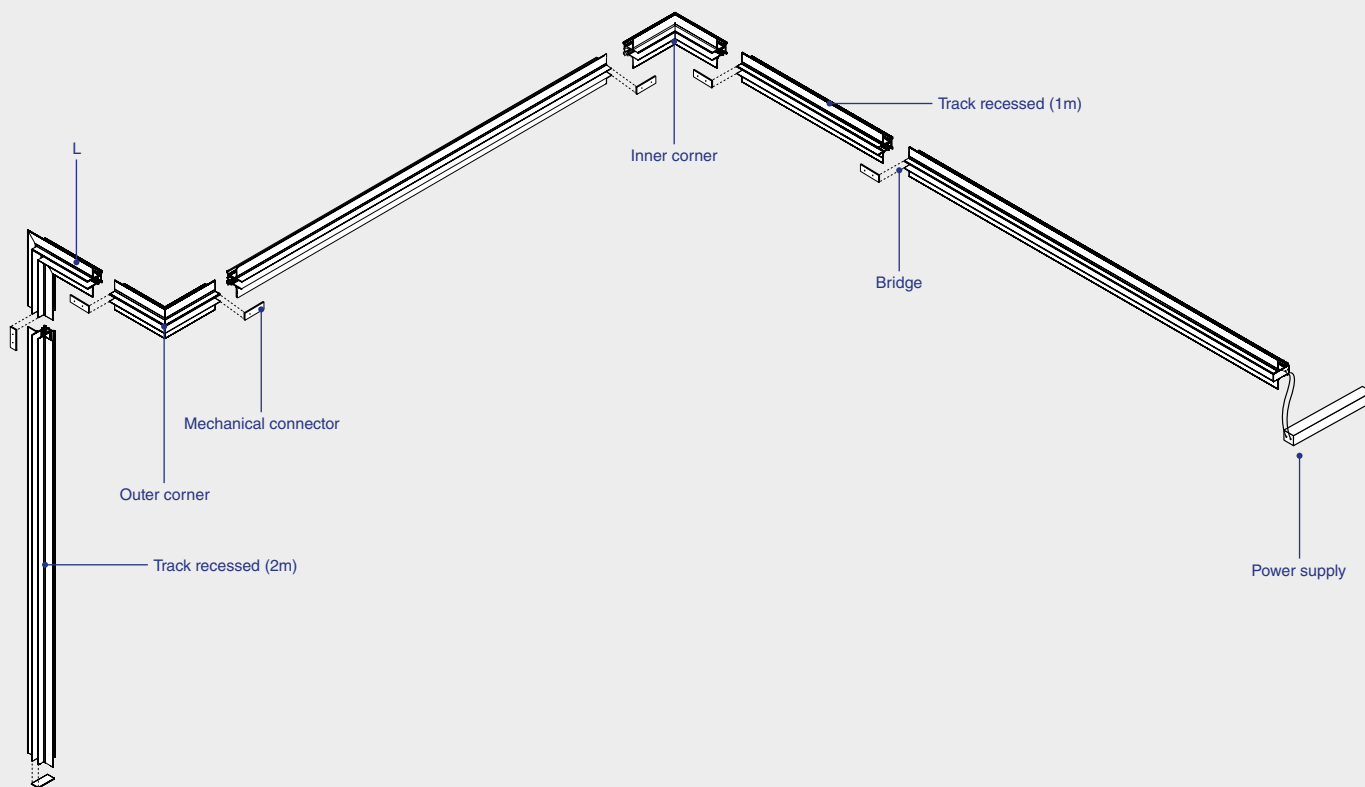

24V

Family	Track Length	Finish	Control System
6020120 Neso Track Recessed	10 1m	2 Black	D ON/OFF
	20 2m	2	

ACCESSORIES NESO SLIM

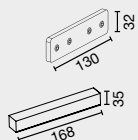

● 6020200102	Mechanical connector
● 6020115102	Bridge
● 6020115102D	Bridge DALI
● 6020R120102	Track cover
POWER SUPPLY	
98324120	Power supply 120W
98324150	Power supply 150W
98324180	Power supply 180W
98324200	Power supply 200W

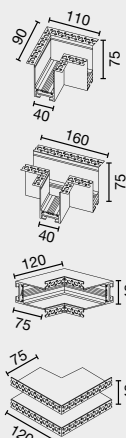

● 6020221002	L
● 6020221002D	L DALI
● 6020221102	T
● 6020221102D	T DALI
● 6020221202	Inner corner
● 6020221202D	Inner corner DALI
● 6020221302	Outer corner
● 6020221302D	Outer corner DALI

TRACK SURFACE & SUSPENSION

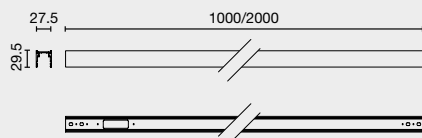
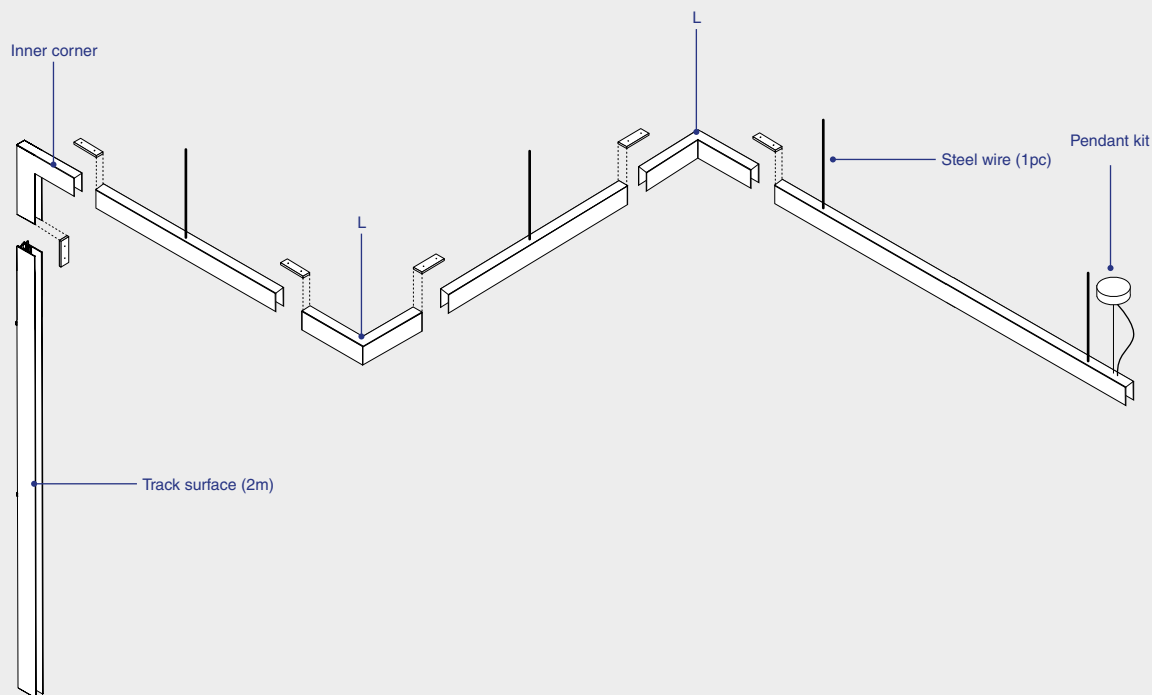

24V

Family	Track Length	Finish	Control System
6020110 Neso Track Surface	10 1m	2 Black	D ON/OFF
	20 2m		

ACCESSORIES NESO SLIM



● 6020200102	Mechanical connector
● 6020200103	Surface mounting Kit
● 6020210202	Pendant Kit
● 6020210202D	Pendant kit DALI

6020210102	Steel wire
6020R120102	Track cover

POWER SUPPLY

98324120	Power supply 120W
98324150	Power supply 150W
98324180	Power supply 180W
98324200	Power supply 200W

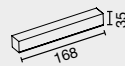

● 6020115102	Bridge
● 6020115102D	Bridge DALI

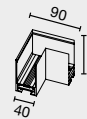

● 6020211002	L
● 6020211002D	L DALI

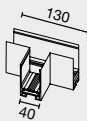

● 6020211102	T
● 6020211102D	T DALI

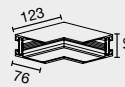

● 6020211202	Inner corner
● 6020211202D	Inner corner DALI

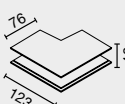

● 6020211302	Outer corner
● 6020211302D	Outer corner DALI

NESO SLIM POINT 12L

no incl. 50.000hs L70/B10 MacAdam 3 24V 650°C UGR <16

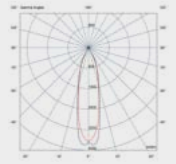
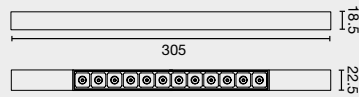

25°

NESO SLIM POINT 24L

no incl. 50.000hs L70/B10 MacAdam 3 24V 650°C UGR <16

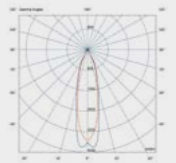

25°

Family	Color T°	Beam Angle	Finish	Control System
60103 Point slim 24L 24W	927 2700K 1674lm CRI>90	1 25°	2 Black	W CASAMBI
	930 3000K 1726lm CRI>90			D DALI
				ON/OFF



NESO SLIM LINE 30cm

no incl. 50.000hs L70/B10  MacAdam 3 24V  650°C

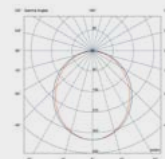
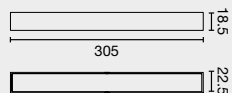

Family

Color T°

Finish

Control System

60104 Line slim 30cm 6W

927 2700K 322lm CRI>90

02 Black

W CASAMBI

930 3000K 332lm CRI>90

D DALI

ON/OFF

NESO SLIM LINE 70cm

no incl. 50.000hs L70/B10  MacAdam 3 24V  650°C

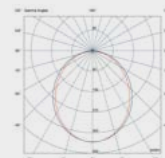
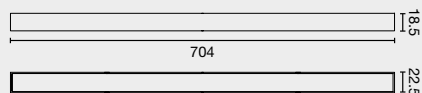

Family

Color T°

Finish

Control System

60105 Line slim 70cm 18W

927 2700K 875lm CRI>90

02 Black

W CASAMBI

930 3000K 902lm CRI>90

D DALI

ON/OFF

NESO SLIM LINE WALL WASHER 30cm NEW

no incl. 50.000hs L70/B10  MacAdam 3 24V  650°C

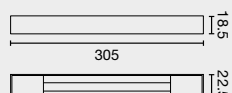

Family

Color T°

Finish

Control System

60111 Line slim wallwasher 30cm 6W

927 2700K 311lm CRI>90

02 Black

W CASAMBI

930 3000K 320lm CRI>90

D DALI

ON/OFF



NESO SLIM HOLE ø3.5cm

no incl. 50.000hs L70/B10 MacAdam 3 24V 650°C

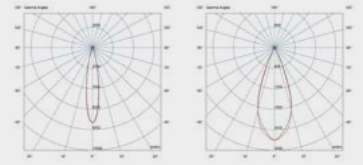
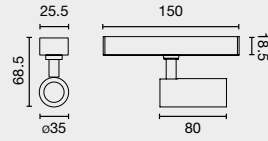

20°

40°

Family	Color T°	Beam Angle	Finish	Control System
60107 Hole slim ø3,5cm 5W	927 2700K 360lm CRI>90 930 3000K 444lm CRI>90	1 20° 2 40°	2 Black	W CASAMBI D DALI ON/OFF

NESO SLIM HOLE ø5cm

no incl. 50.000hs L70/B10 MacAdam 3 24V 650°C

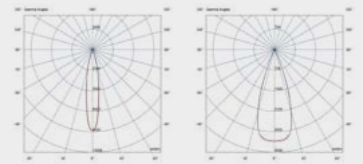
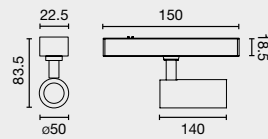

18°

36°

Family	Color T°	Beam Angle	Finish	Control System
60108 Hole slim ø5cm 10W	027 2700K 445lm CRI>90 030 3000K 592lm CRI>90	1 18° 2 36°	2 Black	W CASAMBI D DALI ON/OFF



NESO SLIM UNIK

no incl. 50.000hs L70/B10   MacAdam 3 24V  650°C

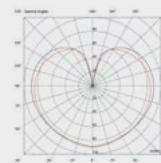
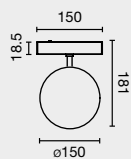

325°

Family **Color T°** **Finish** **Control System**

60108 Unik slim 5W

927 2700K 230lm CRI>90

02 Black

W CASAMBI

930 3000K 237lm CRI>90

D DALI

ON/OFF

NESO SLIM UNIK PENDANT

no incl. 50.000hs L70/B10   MacAdam 3 24V  650°C

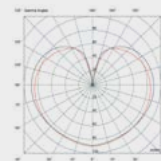
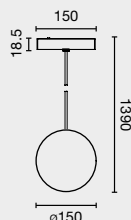

325°

Family **Color T°** **Finish** **Control System**

60109 Unik slim pendant 5W

027 2700K 230lm CRI>90

02 Black

W CASAMBI

030 3000K 237lm CRI>90

D DALI

ON/OFF

NESO SLIM PENDANT

no incl. 50.000hs L70/B10   MacAdam 3 24V  650°C

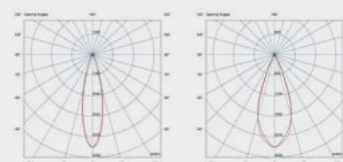
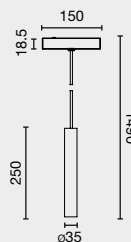

20°

40°

Family **Color T°** **Beam Angle** **Finish** **Control System**

60106 Neso slim pendant 5W

927 2700K 308m CRI>90

1 20°

2 Black

W CASAMBI

930 3000K 320lm CRI>90

2 40°

D DALI

ON/OFF



NESO SLIM ANNA N

no incl. 50.000hs L70/B10 24V 650°C

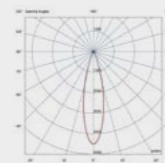
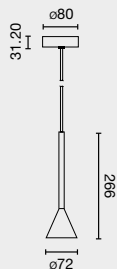

15°

Family **Color T°** **Beam Angle** **Finish** **Control System**

60110 Anna slim pendant 6W

927 2700K CRI90

1 15°

02 Black

W CASAMBI
D DALI
ON/OFF

NESO SLIM DIANA N

no incl. 50.000hs L70/B10 24V 650°C

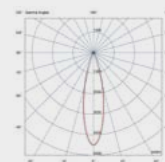
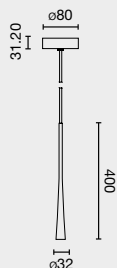

18°

Family **Color T°** **Beam Angle** **Finish** **Control System**

60112 Diana slim 400 6W

927 2700K CRI90

1 18°

02 Black

W CASAMBI
D DALI
ON/OFF

60113 Diana slim 600 6W

60114 Diana slim 800 6W

NESO SLIM NINA N

no incl. 50.000hs L70/B10 24V 650°C

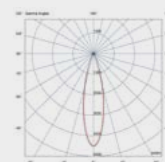
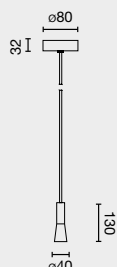

18°

Family **Color T°** **Beam Angle** **Finish** **Control System**

60111 Nina slim 4W

927 2700K CRI90

1 18°

02 Black

W CASAMBI
D DALI
ON/OFF



NESO POINT 3L

Option	Color T°	CRI	Power	Lumen Output	Beam Angle
927	2700k	90	4W	217 / 221lm	12° / 34°
930	3000k	90	4W	292 / 298lm	12° / 34°

NESO POINT 6L

Option	Color T°	CRI	Power	Lumen Output	Beam Angle
927	2700k	90	8W	480 / 487lm	12° / 34°
930	3000k	90	8W	506 / 512lm	12° / 34°

NESO POINT 12L

Option	Color T°	CRI	Power	Lumen Output	Beam Angle
927	2700k	90	8W	1102 / 1109lm	12° / 34°
930	3000k	90	8W	1107 / 1112lm	12° / 34°

NESO LINE 32cm

Option	Color T°	CRI	Power	Lumen Output	Beam Angle
927	2700k	90	6W	892lm	100°
930	3000k	90	6W	920lm	100°

NESO LINE 64cm

Option	Color T°	CRI	Power	Lumen Output	Beam Angle
927	2700k	90	18W	1399lm	100°
930	3000k	90	18W	1442lm	100°

NESO HOLE ø3.5cm

Option	Color T°	CRI	Power	Lumen Output	Beam Angle
927	2700k	90	5W	360 / 372lm	20° / 40°
930	3000k	90	5W	592 / 602lm	20° / 40°

NESO HOLE ø5cm

Option	Color T°	CRI	Power	Lumen Output	Beam Angle
927	2700k	90	10W	825 / 932lm	18° / 36°
930	3000k	90	10W	954 / 961lm	18° / 36°

NESO HOLE ø7cm

Option	Color T°	CRI	Power	Lumen Output	Beam Angle
927	2700k	90	20W	925 / 931lm	18° / 36°
930	3000k	90	20W	954 / 961lm	18° / 36°

NESO UNIK

Option	Color T°	CRI	Power	Lumen Output	Beam Angle
927	2700k	90	5W	256lm	325°
930	3000k	90	5W	264lm	325°

NESO TOP

Option	Color T°	CRI	Power	Lumen Output	Beam Angle
927	2700k	90	5W	360 / 371lm	20° / 40°
930	3000k	90	5W	444 / 452lm	20° / 40°

NESO SLIM POINT 12L

Option	Color T°	CRI	Power	Lumen Output	Beam Angle
927	2700k	90	12W	816lm	25°
930	3000k	90	12W	841lm	25°

NESO SLIM POINT 24L

Option	Color T°	CRI	Power	Lumen Output	Beam Angle
927	2700k	90	24W	1674lm	25°
930	3000k	90	24W	1726lm	25°

NESO SLIM LINE 30cm

Option	Color T°	CRI	Power	Lumen Output	Beam Angle
927	2700k	90	6W	322lm	100°
930	3000k	90	6W	332lm	100°

NESO SLIM LINE 70cm

Option	Color T°	CRI	Power	Lumen Output	Beam Angle
927	2700k	90	18W	875lm	100°
930	3000k	90	18W	902lm	100°

NESO SLIM HOLE ø3.5cm

Option	Color T°	CRI	Power	Lumen Output	Beam Angle
927	2700k	90	5W	334 / 334lm	20° / 40°
930	3000k	90	5W	347 / 344lm	20° / 40°

NESO SLIM HOLE ø5cm

Option	Color T°	CRI	Power	Lumen Output	Beam Angle
927	2700k	90	10W	545 / 572lm	18° / 36°
930	3000k	90	10W	562 / 590lm	18° / 36°

NESO SLIM UNIK

Option	Color T°	CRI	Power	Lumen Output	Beam Angle
927	2700k	90	5W	230lm	325°
930	3000k	90	5W	237lm	325°

NESO SLIM TOP

Option	Color T°	CRI	Power	Lumen Output	Beam Angle
927	2700k	90	5W	308 / 310lm	20° / 40°
930	3000k	90	5W	318 / 320lm	20° / 40°

NESO SLIM ANNA

Option	Color T°	CRI	Power	Lumen Output	Beam Angle
927	2700k	90	6W	203lm	15°

NESO SLIM DIANA

Option	Color T°	CRI	Power	Lumen Output	Beam Angle
927	2700k	90	6W	317lm	18°

NESO SLIM NINA

Option	Color T°	CRI	Power	Lumen Output	Beam Angle
927	2700k	90	4W	108lm	18°



System designed for the general lighting of spaces. VIA system allows the creation of continuous light lines. We can also build different formats using the corner accessory. It can be used in surface, suspension or recessed installations.

Sistema diseñado para la iluminación general de espacios. VIA permite la creación de líneas de luz continuas. También podemos construir formatos diferentes utilizando el accesorio de esquina. Puede utilizarse en instalaciones de superficie, suspensión o empotradas.

WIA



E V O L U T I O N



VIA Collection



Track
59

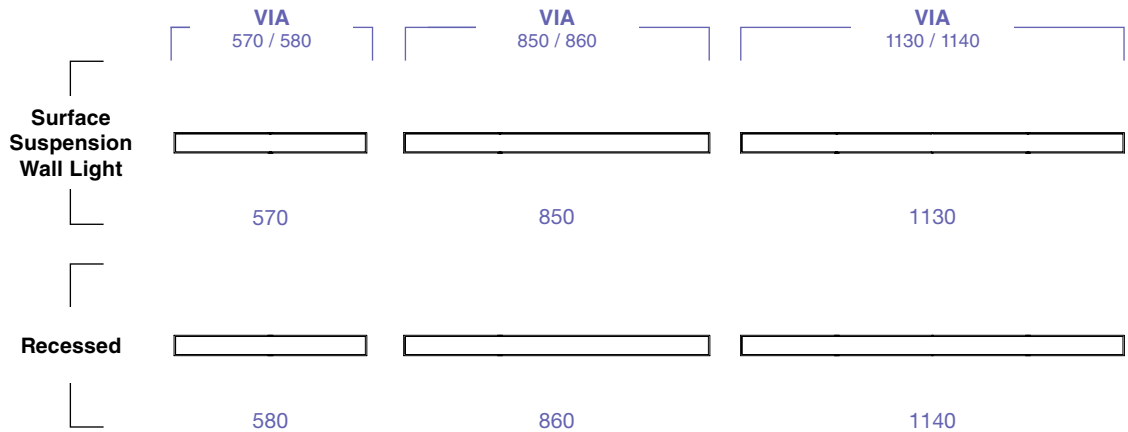

LIGHT DIRECTION
Dirección de la luz

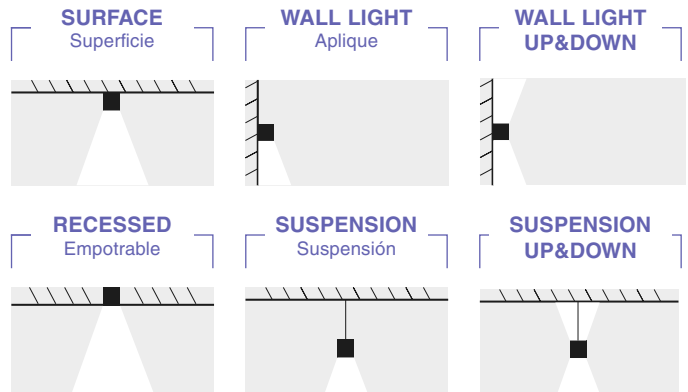



FINISH
Acabado

- Black**
Negro
- White**
Blanco

COLOR TEMPERATURE
Temperatura de color

- 3000K CRI80
- 4000K CRI80
- 2700-3000K

DIFFUSER
Difusor

- 
Opal
- 
Microprisma
- 
UGR

CONTROL SYSTEM
Sistema de Control





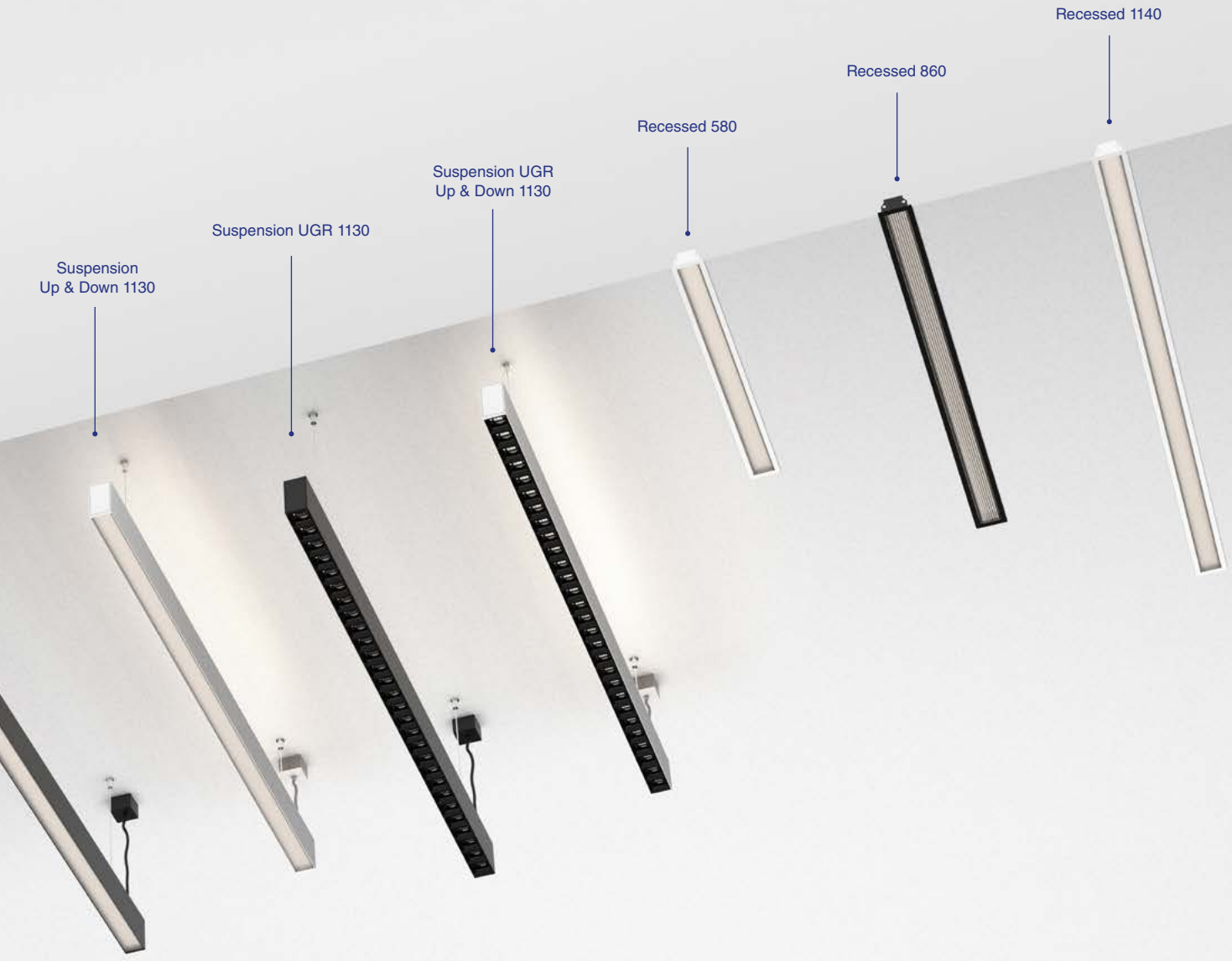

Suspension
Up & Down 1130

Suspension UGR 1130

Suspension UGR
Up & Down 1130

Recessed 580

Recessed 860

Recessed 1140

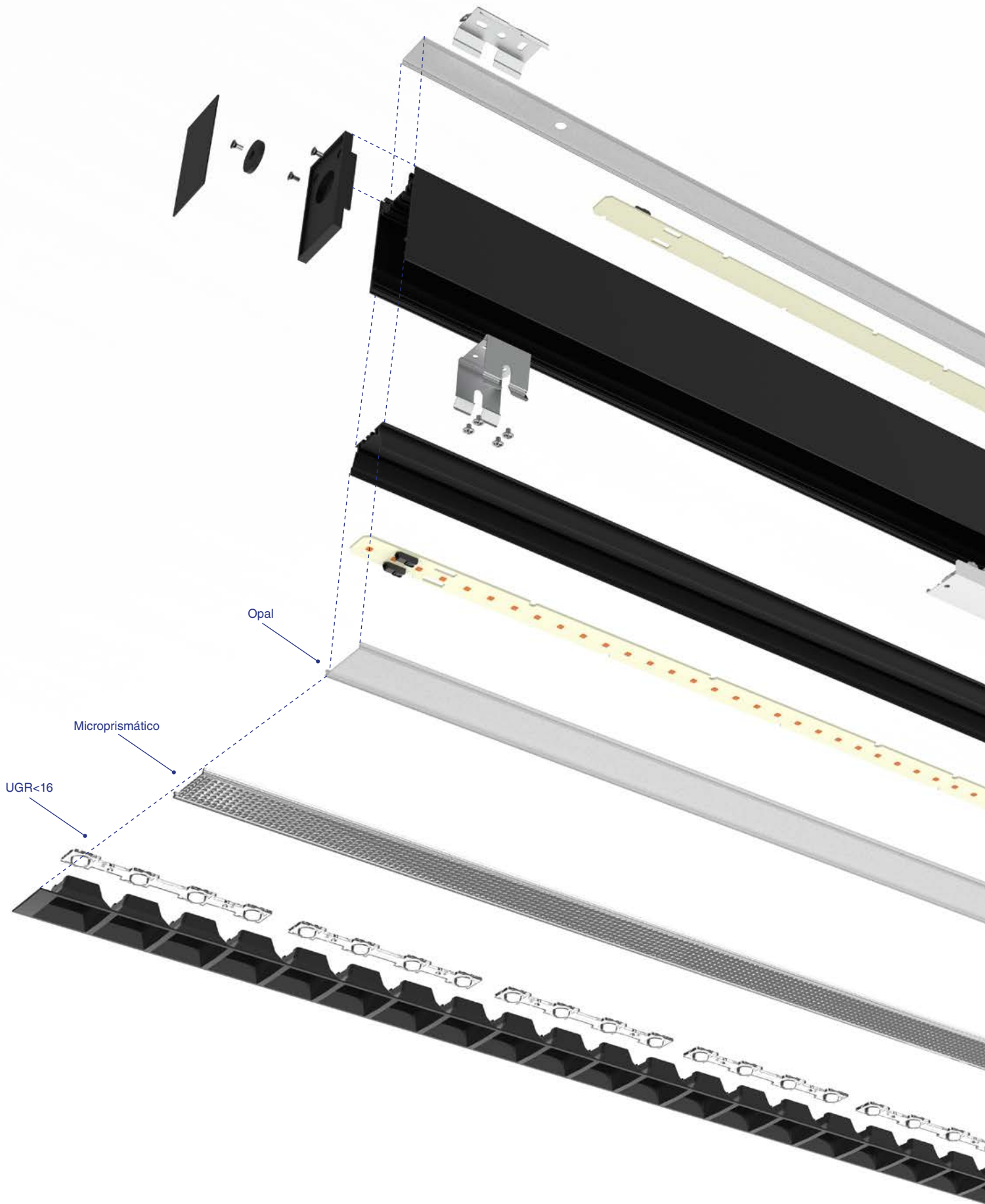

NEW 3D CONFIGURATOR

VIA









Suspension Accessory
Accesorio de suspensión



Suspension Accessory Dali
Accesorio de suspensión Dali



Continuous Accessory Surface (1 pcs)
Accesorio continuo de superficie (1 pcs)



Suspension Wire (2 pcs)
Alambre de suspensión (2pcs)



L-Shape without light
Esquina en L sin luz



End Line Sensor
Sensor de fin de línea



Middle Line Sensor
Sensor de línea central

Accessories

	Suspension Accessory	Suspension Accessory Dali	L-Shape Without Light	Continuous Accessory Surface	Suspension Wire	End Line Sensor	Middle Line Sensor
●	040000093	040000095	040000091	040000097	040000098	040000089	040000101
●	040000094	040000096	040000090			040000099	040000100



Residential

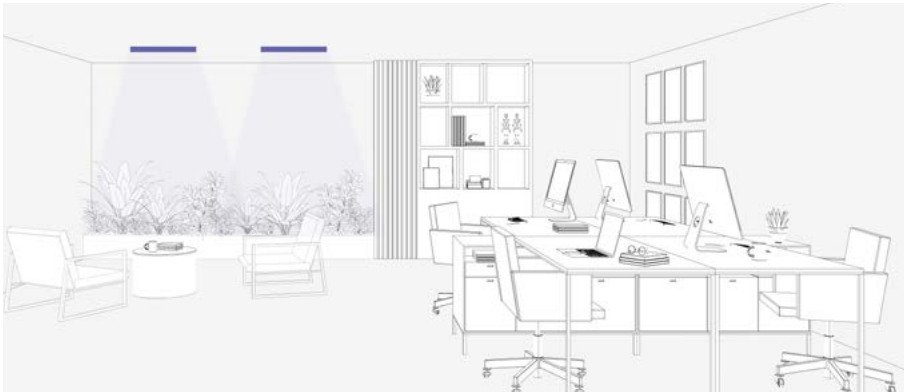

Office



Microprisma

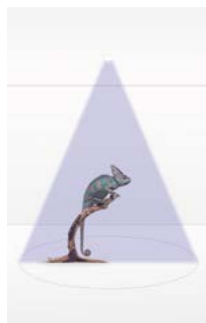

90°



Opal

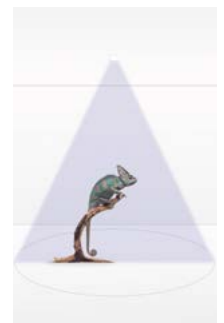

110°



UGR

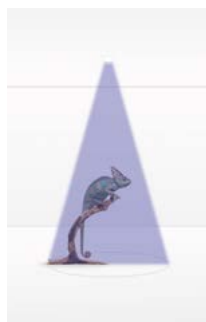

50°

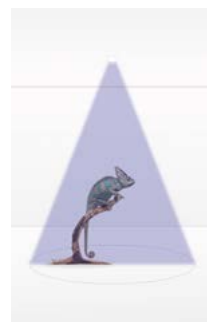

80°

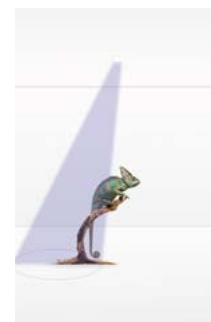

Asym°

VIA SURFACE & SUSPENSION 570

incl. DIM 50.000hs L80/B10 MacAdam 3 TW 220-240V 50 / 60Hz 650°C

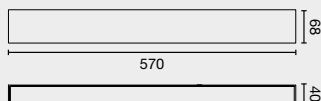

Family	Power	Finish	Control System	Diffuser
04100 Via Evo	590	Surface 15W 3000K CRI80	ON/OFF	Opal
	570	Surface 25W 3000K CRI80	W CASAMBI	U Microprisma
	680	Surface 15W 4000K CRI80	D DALI	
	660	Surface 25W 4000K CRI80		
04101 Via Evo	010	Surface 27W 2700-6500K TW	W CASAMBI	Opal
			D DALI	U Microprisma

04100

570

1

W

Example **041005701W** — Via Evo Surface 570 mm 25W 3000K Opal White

VIA SURFACE & SUSPENSION 850

incl. DIM 50.000hs L80/B10 MacAdam 3 TW 220-240V 50 / 60Hz 850°C

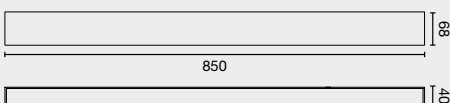

Family	Power	Finish	Control System	Diffuser
04100 Via Evo	560	Surface 20W 3000K CRI80	ON/OFF	Opal
	540	Surface 38W 3000K CRI80	W CASAMBI	U Microprisma
	650	Surface 20W 4000K CRI80	D DALI	
	630	Surface 38W 4000K CRI80		
04101 Via Evo	030	Surface 39W 2700-6500K TW	W CASAMBI	Opal
			D DALI	U Microprisma

VIA SURFACE & SUSPENSION 1130

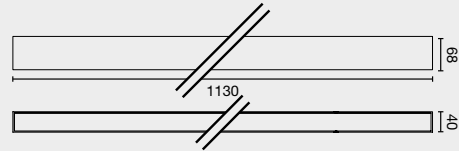
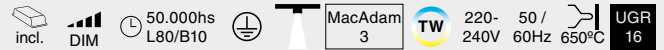

Family	Power	Finish	Control System	Diffuser
04100 Via Evo	530 Surface 27W 3000K CRI80	1 White	ON/OFF	Opal
	510 Surface 51W 3000K CRI80	2 Black	W CASAMBI	U Microprisma
	620 Surface 27W 4000K CRI80		D DALI	
	600 Surface 51W 4000K CRI80			
04101 Via Evo	050 Surface 48W 2700-6500K TW	1 White	W CASAMBI	Opal
		2 Black	D DALI	U Microprisma
04102 Via Evo	110 Surface UGR 32W 3000K CRI80	1 White	ON/OFF	8 UGR<19 80°
	120 Surface UGR 32W 4000K CRI80	2 Black	W CASAMBI	5 UGR<16 50°
	111 Surface UGR 17W 3000K CRI80		D DALI	0 UGR<19 asim.
	121 Surface UGR 17W 4000K CRI80			
04103 Via Evo	010 Surface UGR 54W 2700-6500K TW	1 White	W CASAMBI	8 UGR<19 80°
		2 Black	D DALI	5 UGR<16 50° 0 UGR<19 asim.

VIA L-SHAPE

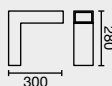

Accessory	Power	Finish	Control System	Diffuser
04100 L-shape	961 3000K 15W	1 White	ON/OFF	Opal
	971 4000K 15W	2 Black	W CASAMBI	U Microprisma
	981 3000K 25W		D DALI	
	991 4000K 25W			
04100 L-shape	951 TW 27W	1 White	W CASAMBI	Opal
		2 Black	D DALI	U Microprisma

Combine different VIA models. See colours to check compatibility of models in "L" installations or continuous lines.
 Combina distintos modelos de VIA. Mira los colores para verificar las compatibilidades de modelos en instalaciones en "L" o líneas continuas.



Systems

VIA UP&DOWN 850

*Always order Suspension Kit
*Siempre pedir Kit de suspensión

incl. DIM 50.000hs L80/B10 MacAdam 3 220-240V 50 / 60Hz 650°C

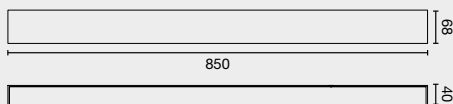

Family	Power	Finish	Control System	Diffuser
04200 Via Evo	540	Up&down 14+38W 3000K CRI80	ON/OFF	Opal
	630	Up&down 14+38W 4000K CRI80	W CASAMBI D DALI	U Microprisma

VIA UP&DOWN 1130

*Always order Suspension Kit
*Siempre pedir Kit de suspensión

incl. DIM 50.000hs L80/B10 MacAdam 3 220-240V 50 / 60Hz 650°C

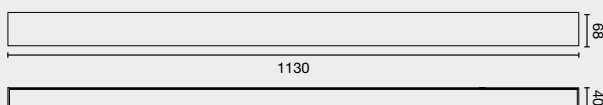

Family	Power	Finish	Control System	Diffuser
04200 Via Evo	510	Up&down 21+51W 3000K CRI80	ON/OFF	Opal
	600	Up&down 21+51W 4000K CRI80	W CASAMBI D DALI	U Microprisma

VIA UP&DOWN UGR 1130

*Always order Suspension Kit
 *Siempre pedir Kit de suspensión

incl. DIM 50.000hs L80/B10 MacAdam 3 220-240V 50 / 60Hz 650°C UGR 16

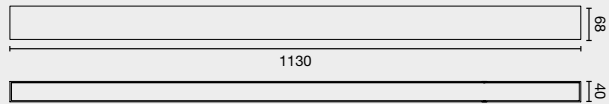

Family	Power	Finish	Control System	Diffuser
04202 Via Evo	110	Up&down UGR 24+32W 3000K CRI80	ON/OFF	8 UGR<19 80°
	120	Up&down UGR 24+32W 4000K CRI80	W CASAMBI D DALI	5 UGR<16 50° 0 UGR<19 asim.

VIA RECESSED 580

incl. DIM 50.000hs L80/B10 MacAdam 3 TW 220-240V 50 / 60Hz 650°C

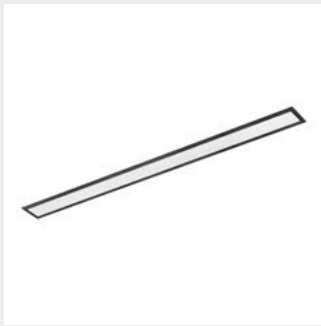

574x50

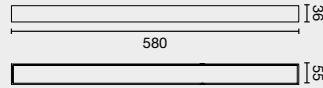

Family	Power	Finish	Control System	Diffuser
04100 Via Evo	770	Recessed 15W 3000K CRI80	ON/OFF	Opal
	750	Recessed 25W 3000K CRI80	W CASAMBI	U Microprisma
	800	Recessed 15W 4000K CRI80	D DALI	
	780	Recessed 25W 4000K CRI80		
04101 Via Evo	020	Recessed 27W 2700-6500K TW	W CASAMBI	Opal
			D DALI	U Microprisma

VIA RECESSED 860

incl. DIM 50.000hs L80/B10 MacAdam 3 TW 220-240V 50 / 60Hz 650°C

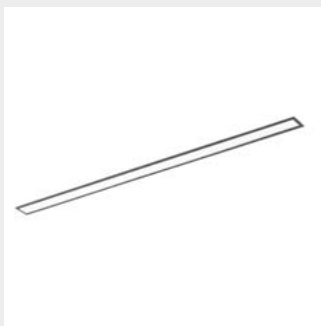

854x50

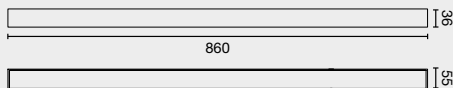

Family	Power	Finish	Control System	Diffuser
04100 Via Evo	0830	Recessed 20W 3000K CRI80	ON/OFF	Opal
	0810	Recessed 38W 3000K CRI80	W CASAMBI	U Microprisma
	0860	Recessed 20W 4000K CRI80	D DALI	
	0840	Recessed 38W 4000K CRI80		
04101 Via Evo	040	Recessed 39W 2700-6500K TW	W CASAMBI	Opal
			D DALI	U Microprisma

VIA RECESSED 1140

incl. DIM 50.000hs L80/B10 MacAdam 3 TW 220-240V 50 / 60Hz 650°C

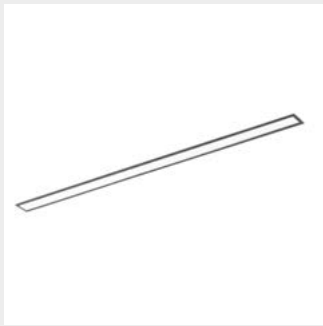

1134x50

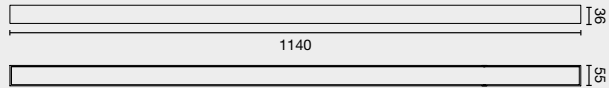

Family	Power	Finish	Control System	Diffuser
04100 Via Evo	0890 Recessed 27W 3000K CRI80	1 White	ON/OFF	Opal
	0870 Recessed 51W 3000K CRI80	2 Black	W CASAMBI	U Microprisma
	0920 Recessed 27W 4000K CRI80		D DALI	
	0900 Recessed 51W 4000K CRI80			
04101 Via Evo	060 Recessed 48W 2700-6500K TW	1 White	W CASAMBI	Opal
		2 Black	D DALI	U Microprisma

VIA WALL LIGHT 570

incl. DIM 50.000hs L80/B10 MacAdam 3 TW 220-240V 50 / 60Hz 650°C

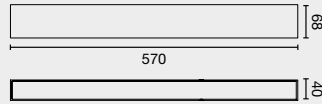

Family	Power		Finish	Control System	Diffuser
04100 Via Evo	595	Wall Light 15W 3000K CRI80	1 White	ON/OFF	Opal
	575	Wall Light 25W 3000K CRI80	2 Black	W CASAMBI	
	685	Wall Light 15W 4000K CRI80		D DALI	
	665	Wall Light 25W 4000K CRI80			
04101 Via Evo	015	Wall Light 27W 2700-6500K TW	1 White	W CASAMBI	Opal
			2 Black	D DALI	

VIA WALL LIGHT 850

incl. DIM 50.000hs L80/B10 MacAdam 3 TW 220-240V 50 / 60Hz 650°C

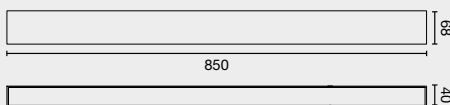

Family	Power		Finish	Control System	Diffuser
04100 Via Evo	565	Wall Light 20W 3000K CRI80	1 White	ON/OFF	Opal
	545	Wall Light 38W 3000K CRI80	2 Black	W CASAMBI	
	655	Wall Light 20W 4000K CRI80		D DALI	
	635	Wall Light 38W 4000K CRI80			
04101 Via Evo	035	Wall Light 39W 2700-6500K TW	1 White	W CASAMBI	Opal
			2 Black	D DALI	

VIA WALL LIGHT 1130

incl. DIM 50.000hs L80/B10 MacAdam 3 TW 220-240V 50 / 60Hz 650°C

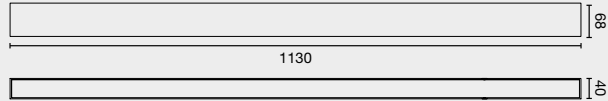

Family	Power	Finish	Control System	Diffuser
04100 Via Evo	535 Wall Light 27W 3000K CRI80	1 White	ON/OFF	Opal
	515 Wall Light 51W 3000K CRI80	2 Black	W CASAMBI	
	625 Wall Light 27W 4000K CRI80		D DALI	
	605 Wall Light 51W 4000K CRI80			
04101 Via Evo	055 Wall Light 48W 2700-6500K TW	1 White	W CASAMBI	Opal
		2 Black	D DALI	

VIA WALL LIGHT UP&DOWN 850

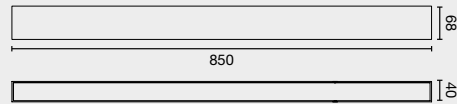
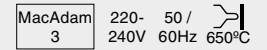
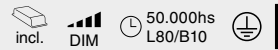

Family	Power		Finish	Control System	Diffuser
04200 Via Evo	545	Wall Light Up&Down 14+38W 3000K CRI80	1 White	ON/OFF	Opal
	635	Wall Light Up&Down 14+38W 4000K CRI80	2 Black	W CASAMBI D DALI	

VIA WALL LIGHT UP&DOWN 1130

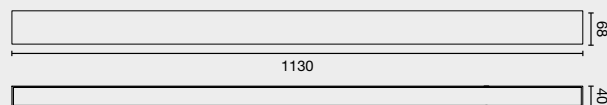
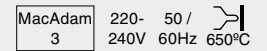
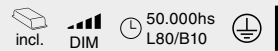

Family	Power		Finish	Control System	Diffuser
04200 Via Evo	515	Wall Light Up&Down 21+51W 3000K CRI80	1 White	ON/OFF	Opal
	605	Wall Light Up&Down 21+51W 4000K CRI80	2 Black	W CASAMBI D DALI	

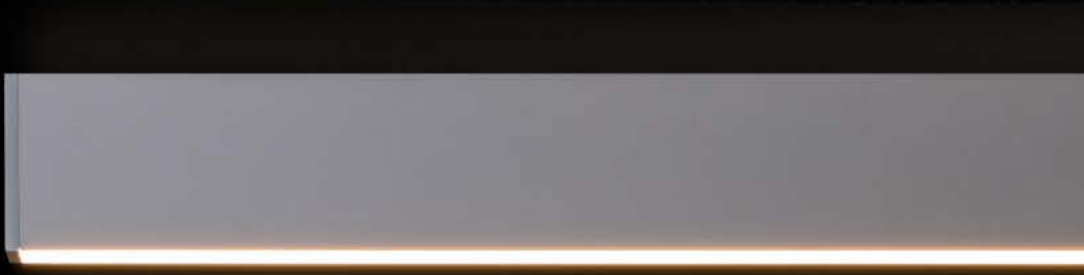

VIA SURFACE & SUSPENSION

570mm						
Option	Color T°	CRI	Difusor	Power	Lumen Output	Beam Angle
590	3000K	80	Opal / Microprisma	15W	1392lm / 1133lm	110° / 90°
570		80	Opal / Microprisma	25W	2506m / 2039m	110° / 90°
680	4000K	80	Opal / Microprisma	15W	1434lm / 1167lm	110° / 90°
660		80	Opal / Microprisma	25W	2581lm / 2100lm	110° / 90°
010	2700-6500K	TW	Opal / Microprisma	27W	1964lm / 1598lm	110° / 90°
850mm						
560	3000K	80	Opal / Microprisma	20W	2131lm / 1735lm	110° / 90°
540		80	Opal / Microprisma	38W	3809lm / 3121lm	110° / 90°
650	4000K	80	Opal / Microprisma	20W	2195lm / 1787lm	110° / 90°
630		80	Opal / Microprisma	39W	3923lm / 3214lm	110° / 90°
030	2700-6500K	TW	Opal / Microprisma	39W	2985lm / 2429lm	110° / 90°
1130mm						
530	3000K	80	Opal / Microprisma	27W	2842lm / 2313lm	110° / 90°
510		80	Opal / Microprisma	51W	5112lm / 4161lm	110° / 90°
620	4000K	80	Opal / Microprisma	27W	2927lm / 2382lm	110° / 90°
600		80	Opal / Microprisma	51W	5265lm / 4286lm	110° / 90°
050	2700-6500K	TW	Opal / Microprisma	48W	4006lm / 3261lm	110° / 90°
110	3000K	80	UGR<16 / UGR<19	32W	3989lm / 4104lm / 3739lm	50° / 80° / Asym
120	4000K	80	UGR<16 / UGR<19	32W	4109lm / 4227lm / 3851lm	50° / 80° / Asym
010	2700-6500K	TW	UGR<16 / UGR<19	54W	4830lm / 4881lm / 4467lm	50° / 80° / Asym

VIA UP&DOWN

850mm						
Option	Color T°	CRI	Difusor	Power	Lumen Output	Beam Angle
540	3000K	80	Opal / Microprisma	14 + 38W	1240 + 3809lm / 1323 + 3121lm	110° / 90°
630	4000K	80	Opal / Microprisma	14 + 38W	1278 + 3923lm / 1363 + 3214lm	110° / 90°
1130mm						
510	3000K	80	Opal / Microprisma	21 + 51W	2794 + 5112lm / 2794 + 4161lm	110° / 90°
600	4000K	80	Opal / Microprisma	21 + 51W	2878 + 5265lm / 2878 + 4286lm	110° / 90°
1130mm						
110	3000K	80	UGR<16 / UGR<19	24 + 32W	2794 + 3989lm / 2794 + 4104lm / 2794 + 3739lm	50° / 80° / Asym
120	4000K	80	UGR<16 / UGR<19	24 + 32W	2878 + 4109lm / 2878 + 4227lm / 2878 + 3851lm	50° / 80° / Asym

VIA WALL LIGHT UP&DOWN

850mm						
Option	Color T°	CRI	Difusor	Power	Lumen Output	Beam Angle
545	3000K	80	Opal	14+38W	1240 + 3809lm	110°
635	4000K	80	Opal	14+38W	1278 + 3923lm	110°
1130mm						
515	3000K	80	Opal	21+51W	2794 + 5112lm	110°
605	4000K	80	Opal	21+51W	2878 + 5265lm	110°

VIA RECESSED

580mm						
Option	Color T°	CRI	Difusor	Power	Lumen Output	Beam Angle
770	3000K	80	Opal / Microprisma	15W	1392lm / 1133lm	110° / 90°
750		80	Opal / Microprisma	25W	2506m / 2039m	110° / 90°
800	4000K	80	Opal / Microprisma	15W	1434lm / 1167lm	110° / 90°
780		80	Opal / Microprisma	25W	2581lm / 2100lm	110° / 90°
020	2700-6500K	TW	Opal / Microprisma	27W	1964lm / 1598lm	110° / 90°
860mm						
0830	3000K	80	Opal / Microprisma	20W	2131lm / 1735lm	110° / 90°
0810		80	Opal / Microprisma	38W	3809lm / 3121lm	110° / 90°
0860	4000K	80	Opal / Microprisma	20W	2195lm / 1787lm	110° / 90°
0840		80	Opal / Microprisma	38W	3923lm / 3214lm	110° / 90°
040	2700-6500K	TW	Opal / Microprisma	39W	2985lm / 2429m	110° / 90°
1140mm						
0890	3000K	80	Opal / Microprisma	27W	2842lm / 2313lm	110° / 90°
0870		80	Opal / Microprisma	51W	5112lm / 4161lm	110° / 90°
0920	4000K	80	Opal / Microprisma	27W	2927lm / 2382lm	110° / 90°
0900		80	Opal / Microprisma	51W	5265lm / 4286lm	110° / 90°
060	2700-6500K	TW	Opal / Microprisma	48W	4006lm / 3261lm	110° / 90°

VIA WALL LIGHT

570mm						
Option	Color T°	CRI	Difusor	Power	Lumen Output	Beam Angle
595	3000K	80	Opal	15W	1392lm	110°
575		80	Opal	25W	2506m	110°
685	4000K	80	Opal	15W	1434lm	110°
665		80	Opal	25W	2581lm	110°
015	2700-6500K	TW	Opal	27W	1964lm	110°
850mm						
565	3000K	80	Opal	20W	2131lm	110°
545		80	Opal	38W	3809lm	110°
655	4000K	80	Opal	20W	2195lm	110°
635		80	Opal	38W	3923lm	110°
035	2700-6500K	TW	Opal	39W	2985lm	110°
1130mm						
535	3000K	80	Opal	27W	2842lm	110°
515		80	Opal	51W	5112lm	110°
625	4000K	80	Opal	27W	2927lm	110°
605		80	Opal	51W	5265lm	110°
055	2700-6500K	TW	Opal	48W	4006lm	110°

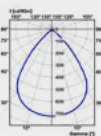

110°

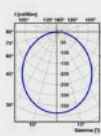

90°

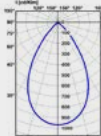

50°

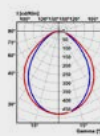

80°

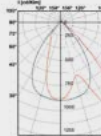

Asym°

FONOVIA is a concept of linear light that isolates us from the environment, creating moments of concentration thanks to its fabric with sound-absorbing properties that in turn softens the light creating spaces of well-being. It accompanies moments of concentration and privacy. Fabric that favours acoustic absorption. Ideal for crowded spaces and meeting rooms.

FONOVIA es un concepto de luz lineal que nos aísla del entorno, creando momentos de concentración gracias a su tejido con propiedades fonoabsorbentes que a su vez suaviza la luz creando espacios de bienestar. Acompaña los momentos de concentración y de privacidad. Tejido que favorece la absorción acústica. Ideal para espacios concurridos y salas de reunión.

DESIGNED BY FAROLAB

FONOVIA



Fonovia 156
25W

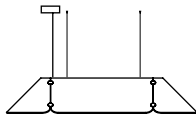

1560

Fonovia 240
50W

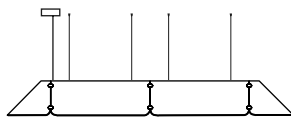

2400

Fonovia
Custom



FINISH
Acabado

● **Grey**
Gris

COLOR TEMPERATURE
Temperatura de color

3000K CRI>80

4000K CRI>80

Highlights

Recycled PET

Because polyester accounts for approximately 60 percent of the world's production of PET, developing a non-virgin supply chain for polyester fiber has the potential to massively impact global energy and resource requirements.

Debido a que el poliéster representa aproximadamente el 60 por ciento de la producción mundial de PET, el desarrollo de una cadena de suministro no virgen para la fibra de poliéster tiene el potencial de impactar masivamente los requerimientos globales de energía y recursos.



Sound Absorbing $\alpha = 0.9$

Noise in offices and workplaces has direct consequences on worker performance. The most immediate one is the reduction of their concentration. Workers exposed to continuous noise in their workplace are less effective in their work tasks. Concentration often means giving the brain a break to think better and focus on an activity. Luminaires made from fabrics with noise-absorbing properties are perfect for work spaces with high noise levels and acoustic distractions.

El ruido en las oficinas y lugares de trabajo tiene consecuencias directas en el rendimiento de los trabajadores. La más inmediata es la reducción de su concentración. Los trabajadores expuestos a un ruido continuo en su lugar de trabajo son menos eficaces en sus tareas. La concentración suele significar dar un respiro al cerebro para pensar mejor y centrarse en una actividad. Las luminarias fabricadas con tejidos con propiedades de absorción del ruido son perfectas para espacios de trabajo con altos niveles de ruido y distracciones acústicas.

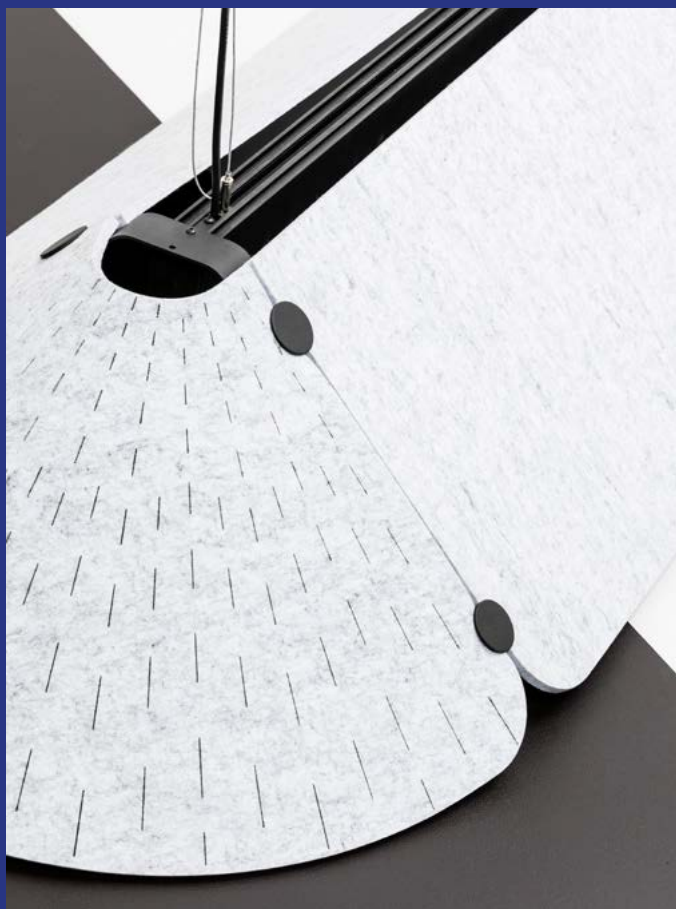

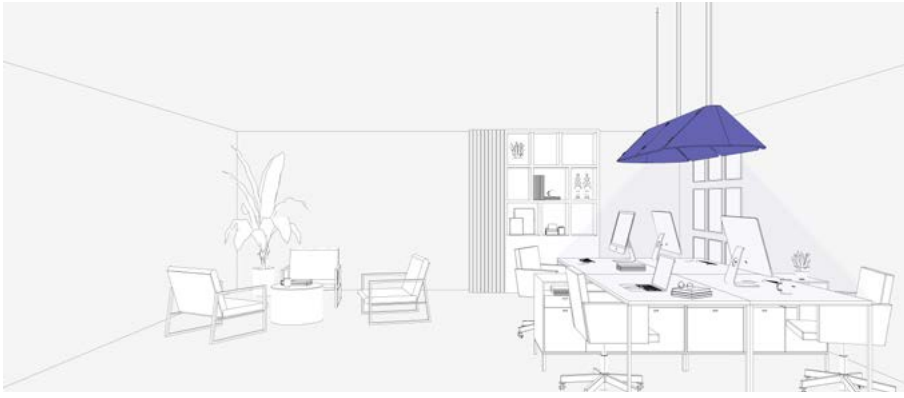

Office

Beam Angle



90°

FONOVIA 156cm 25W

incl. 50.000hs L80 / B10 MacAdam 3 220-240V 50 / 60Hz 650°C

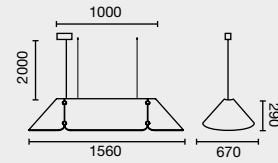

Reference	Finish	Power	Color T°	Lumen Output
20110	● Grey	25W	3000K CRI>80	1800lm
20109	● Grey	25W	4000K CRI>80	1900lm

FONOVIA 240cm 50W

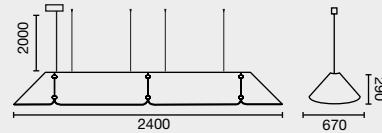

Reference	Finish	Power	Color T°	Lumen Output
20107	● Grey	50W	3000K CRI>80	3600lm
20108	● Grey	50W	4000K CRI>80	3800lm



CONFIGURE YOUR

FONOVIA



1

Choose your via pendant composition
Escoge tu composición de via colgante

VIA SURFACE & SUSPENSION 850



Family	Power	Finish	Control System	Diffuser
04100 Via Evo	560	Surface 20W 3000K CRI80	ON/OFF	Opal
	540	Surface 38W 3000K CRI80	W CASAMBI	U Microprisma
	650	Surface 20W 4000K CRI80	D DALI	
	630	Surface 38W 4000K CRI80		
04101 Via Evo	030	Surface 39W 2700-6500K TW	W CASAMBI	Opal
			D DALI	U Microprisma

VIA SURFACE & SUSPENSION 1130

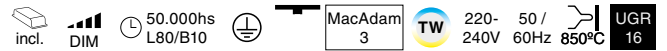

Family	Power	Finish	Control System	Diffuser
04100 Via Evo	530	Surface 27W 3000K CRI80	ON/OFF	Opal
	510	Surface 51W 3000K CRI80	W CASAMBI	U Microprisma
	620	Surface 27W 4000K CRI80	D DALI	
	600	Surface 51W 4000K CRI80		
04101 Via Evo	050	Surface 48W 2700-6500K TW	W CASAMBI	Opal
			D DALI	U Microprisma
04102 Via Evo	110	Surface UGR 32W 3000K CRI80	ON/OFF	8 UGR<19 80°
	120	Surface UGR 32W 4000K CRI80	W CASAMBI	5 UGR<16 50°
04103 Via Evo	010	Surface UGR 54W 2700-6500K TW	D DALI	0 UGR<19 asim.
			W CASAMBI	8 UGR<19 80°
			D DALI	5 UGR<16 50°
				0 UGR<19 asim.

2

Choose your pendant accessory
Escoge tu accesorio colgante

Pendant Accessory	Pendant Accessory Dali
○ 04000093	04000095
● 04000094	04000096

3

Dress your VIA EVO SYSTEM with fonovia sound absorbing shade system
 Viste tu SISTEMA VIA EVO con el sistema de pantallas fonoabsorbentes fonovia

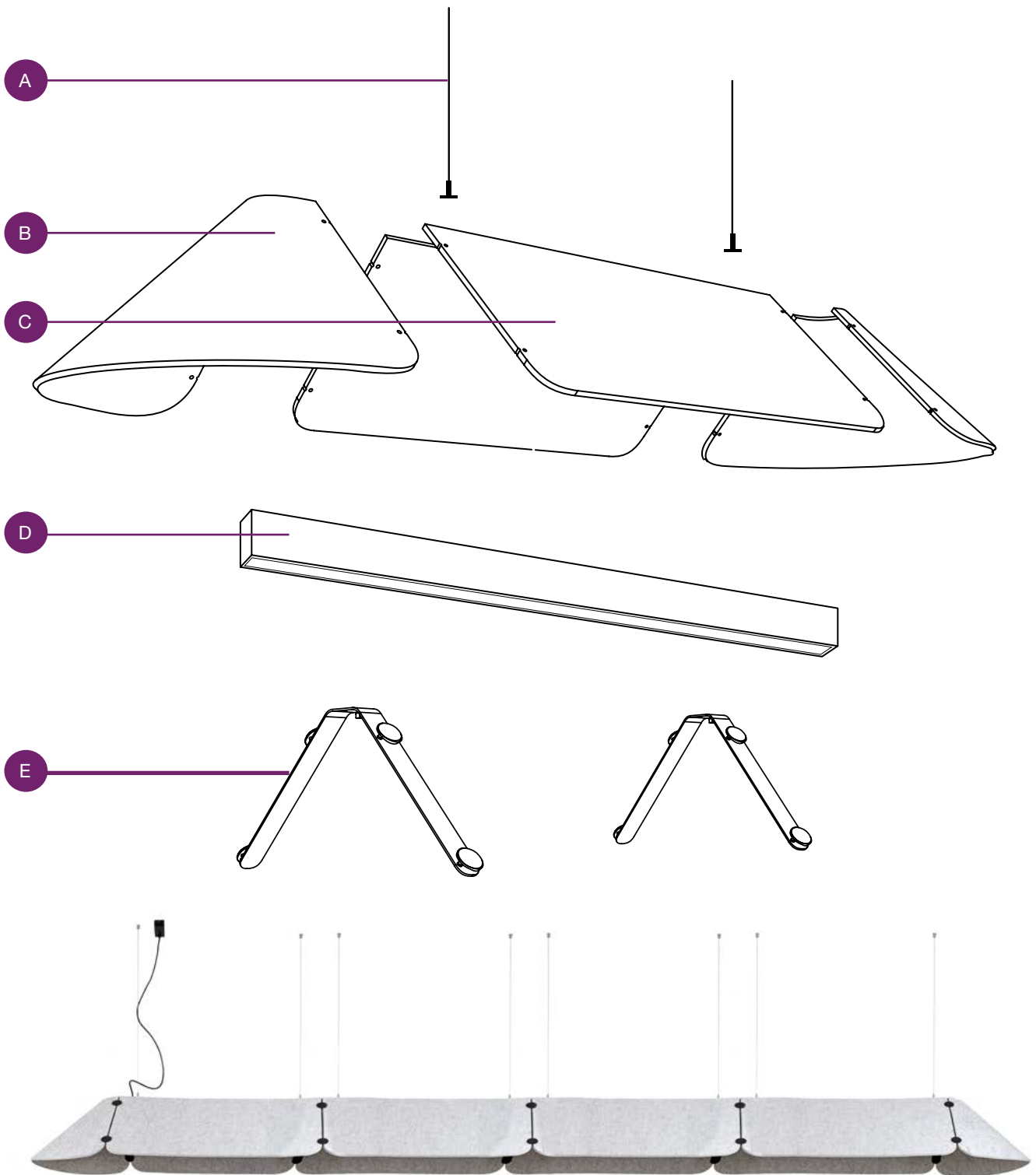

- Example **041005601W** — 4pc. x Via Evo Surface 20W 3000K CRI80 White Casambi
041080001 — 4pc. x 2ud.Fonovia Panels 837x400x9
040000094 — 1pc. x Pendant Accessory Black
040000098 — 4pc. x Accessory wire suspension
041080004 — 5pc. x Kit Soporte Fonovia Negro
041080003 — 1pc. x 2 Paneles Fonovia Conics



A

Accessory wire suspension
Accesorio cables de suspensión
1pc.— 04000098
For each VIA EVO
Por cada VIA EVO

Pendant Accessory
Accesorio suspensión on/off
1pc.— ● 04000093
1pc.— ● 04000094
For each FONOVIA SYSTEM
Por cada FONOVIA SYSTEM

Pendant Accessory DALI
Accesorio suspensión on/off
1pc.— ● 04000095
1pc.— ● 04000096
For each FONOVIA SYSTEM
Por cada FONOVIA SYSTEM



B

For each complet system of VIA EVO
Para cada sistema completo de VIA EVO
1pc. — 041080003
2 Fonovia Conics Panels 359x664x9
2 Paneles Fonovia Conics 359x664x9



C

For each 850cm. VIA EVO
Por cada VIA EVO de 850cm.
1pc.— 041080001
2 Fonovia Panels 837x400x9 Light Grey
2 Paneles Fonovia 837x400x9 Gris Claro

For each 1130cm. VIA EVO
Por cada VIA EVO de 1130cm.
1pc. — 041080002
2 Fonovia Panels 1117x400x9 Light Grey Claro
2 Paneles Fonovia 1117x400x9 Gris



D

Choose your via pendant composition
Escoge tu composición VIA colgante



E

041080004 — Kit Soporte Fonovia Negro
If you have 1 VIA EVO, use 2 supports.
If you have 2 VIA EVO, use 3 supports.
If you have 3 VIA EVO, use 4 supports.
(Always one unit more than the number of tracks)

Si tienes 1 VIA EVO, usa 2 soportes.
Si tienes 2 VIA EVO, usa 3 soportes.
Si tienes 3 VIA EVO, usa 4 soportes.
(Siempre una unidad más que el número de luminarias VIA)

L E E D S

T R I P



LED STRIP
Tiras Led

MONOCHROMATIC
Monocolor

COB

IP67 NEON

5 W	15 W	Tunable White	Neon IP67
9,6 W	19,2 W	RGB	

INDEX PROTECTION
Índice de protección

IP20	IP66	IP67
------	------	------

COLOR TEMPERATURE
Temperatura de color

2700K CRI80	3000K CRI80	4000K CRI80	2700-6500K	RGB	RGBW	
-------------	-------------	-------------	------------	-----	------	--

PROFILE
Perfiles

RECESSED
Empotrables

SURFACE
Superficie

FINISH
Acabado

● **Black**
Negro

○ **White**
Blanco

● **Silver**
Plateado

DIFFUSER
Difusor

○ **Transparent**

○ **Opal**



EMMME Studio | Photo by Lupe Clemente



LEDSTRIP MONOCHROMATIC 5W/m

no incl. 5mt. DIM MacAdam 3 24V CRI>80

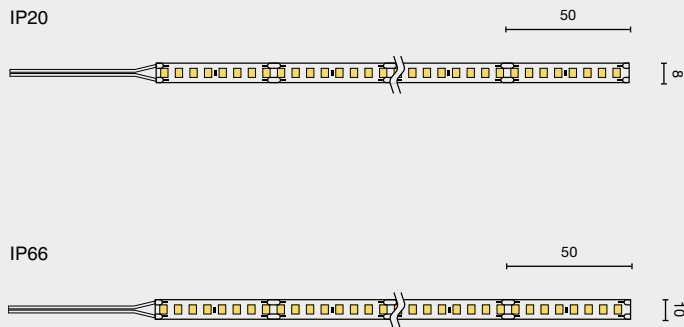

Ref	Power (W/m)	Color T°	lm output/m	LED/m	IP	Cut
08050306	5W	2700K	700	160 led/m	20	50 mm
08050307	5W	3000K	725	160 led/m	20	50 mm
08050308	5W	4000K	775	160 led/m	20	50 mm
08050901	5W	2700K	625	160 led/m	66	50 mm
08050902	5W	3000K	650	160 led/m	66	50 mm
08050903	5W	4000K	675	160 led/m	66	50 mm

*Roll of 5m (500cm). You can order your own custom length every 10cm.
Cut to measure: ref. -XX, where XX=length (-01=0,1m, -02=0,2m, -14=1,4m...)

* Bobina de 5m (500cm) de longitud. Puede pedir su propia longitud personalizada cada 10cm.
Corte a medida: ref. -XX, donde XX=longitud (-01=0,1m, -02=0,2m, -14=1,4m...)

LEDSTRIP MONOCHROMATIC 9.6W/m

no incl. 5mt. DIM MacAdam 3 24V CRI>80

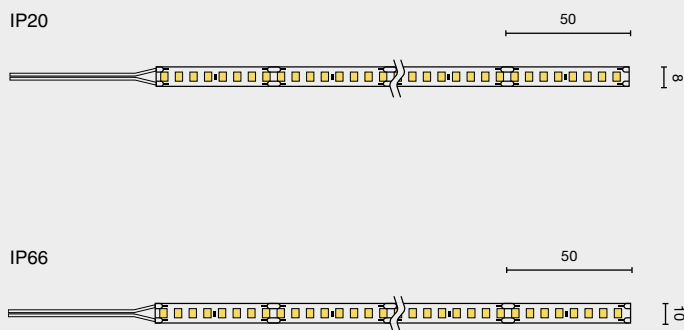

Ref	Power (W/m)	Color T°	lm output/m	LED/m	IP	Cut
08050106	9.6W	2700K	1300	160 led/m	20	50 mm
08050107	9.6W	3000K	1320	160 led/m	20	50 mm
08050108	9.6W	4000K	1360	160 led/m	20	50 mm
08050301	9.6W	2700K	1300	160 led/m	66	50 mm
08050302	9.6W	3000K	1320	160 led/m	66	50 mm
08050303	9.6W	4000K	1360	160 led/m	66	50 mm

*Roll of 5m (500cm). You can order your own custom length every 10cm.
Cut to measure: ref. -XX, where XX=length (-01=0,1m, -02=0,2m, -14=1,4m...)

* Bobina de 5m (500cm) de longitud. Puede pedir su propia longitud personalizada cada 10cm.
Corte a medida: ref. -XX, donde XX=longitud (-01=0,1m, -02=0,2m, -14=1,4m...)



LEDSTRIP MONOCHROMATIC 15W/m

no incl. 5mt. 24V CRI>80

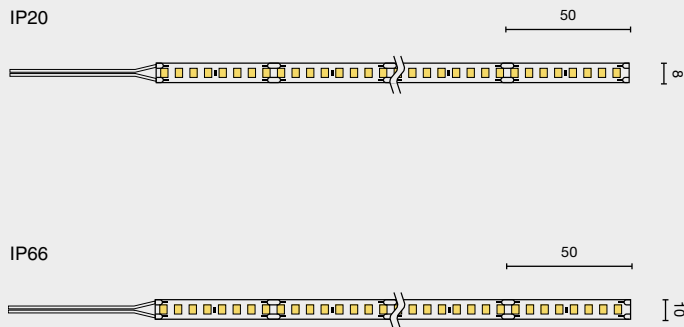

Ref	Power (W/m)	Color T°	lm output/m	LED/m	IP	Cut
08050406	15W	2700K	2025	160 led/m	20	50 mm
08050407	15W	3000K	2070	160 led/m	20	50 mm
08050408	15W	4000K	2175	160 led/m	20	50 mm
08050801	15W	2700K	1800	160 led/m	66	50 mm
08050802	15W	3000K	1845	160 led/m	66	50 mm
08050803	15W	4000K	1950	160 led/m	66	50 mm

*Roll of 5m (500cm). You can order your own custom length every 10cm.
Cut to measure: ref. -XX, where XX=length (-01=0,1m, -02=0,2m, -14=1,4m...)

* Bobina de 5m (500cm) de longitud. Puede pedir su propia longitud personalizada cada 10cm.
Corte a medida: ref. -XX, donde XX=longitud (-01=0,1m, -02=0,2m, -14=1,4m...)

LEDSTRIP MONOCHROMATIC 19.2W/m

no incl. 5mt. 24V CRI>80

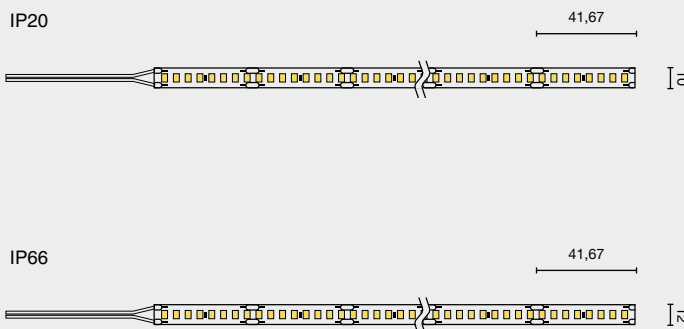

Ref	Power (W/m)	Color T°	lm output/m	LED/m	IP	Cut
08050201	19.2W	2700K	2500	192 led/m	20	41,67 mm
08050202	19.2W	3000K	2520	192 led/m	20	41,67 mm
08050203	19.2W	4000K	2600	192 led/m	20	41,67 mm
08050401	19.2W	2700K	2500	192 led/m	66	41,67 mm
08050402	19.2W	3000K	2520	192 led/m	66	41,67 mm
08050403	19.2W	4000K	2600	192 led/m	66	41,67 mm

*Roll of 5m (500cm). You can order your own custom length every 12,5cm.
Cut to measure: ref. -XXXX, where XXXX=length (-0115=0,125m, -1000 =1m ...)

* Bobina de 5m (500cm) de longitud. Puede pedir su propia longitud personalizada cada 12,5cm
Corte a medida: ref. -XXXX, donde XXXX=longitud (-0125=0,125m, -1000 =1m ...)

ACCESSORIES

08050696	UNION ACCESSORY LED STRIP 8mm	Accesorio unión tira led 8mm
08050697	UNION ACCESSORY LED STRIP 10mm	Accesorio unión tira led 10mm
08050698	CONNECTOR CABLE ACCESSORY LED STRIP 8mm	Accesorio conector cable tira led 8mm
08050699	CONNECTOR CABLE ACCESSORY LED STRIP 10mm	Accesorio conector cable tira led 10mm



LEDSTRIP COB TUNABLE WHITE

no incl.  5mt.  DIM  24V  CRI>90  TW 

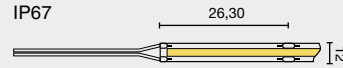
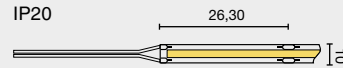

Ref	Power (W/m)	Color T°	lm output/m	IP	Cut
08050501	12W + 12W	2700-6500K	1080 + 1248	20	26,3 mm
08050511	12W + 12W	2700-6500K	1080 + 1248	67	26,3 mm

*Roll of 5m (500cm). You can order your own custom lenght every 10,5cm.
Cut to measure: ref. -XXX, where XXX=length (-0105=0,105m, -1052 =1,052m ...)

* Bobina de 5m (500cm) de longitud. Puede pedir su propia longitud personalizada cada 10,5cm
Corte a medida: ref. -XXX, donde XXX=longitud (-0105=0,105m, -1052 =1,052m ...)

LEDSTRIP COB RGB

no incl.  5mt.  DIM  24V 

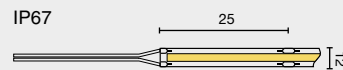
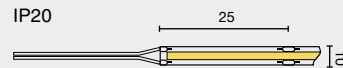
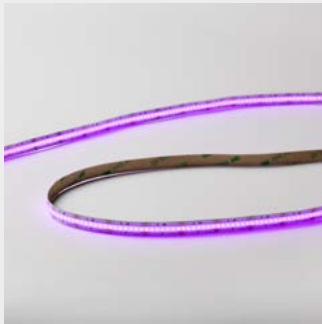

Ref	Power (W/m)	Color T°	lm output/m	IP	Cut
08050601	15W	RGB	550	20	25 mm
08050611	15W	RGB	550	67	25 mm

*Roll of 5m (500cm). You can order your own custom lenght every 10cm.
Cut to measure: ef. -XXX, where XX=length (-01 =0,1m, -02=0,2m, -14=1,4m...)

* Bobina de 5m (500cm) de longitud. Puede pedir su propia longitud personalizada cada 10cm
Corte a medida: ref. -XXX, donde XX=length (-01 =0,1m, -02=0,2m, -14=1,4m...)

LEDSTRIP RGB WHITE

no incl.  5mt.  DIM  24V 



Ref	Power (W/m)	Color T°	lm output/m	IP	Cut
08050706	24w	RGBWhite	1368	20	62mm

*Roll of 5m (500cm). You can order your own custom lenght every 10cm.
Cut to measure: ef. -XXX, where XX=length (-01 =0,1m, -02=0,2m, -14=1,4m...)

* Bobina de 5m (500cm) de longitud. Puede pedir su propia longitud personalizada cada 10cm
Corte a medida: ref. -XXX, donde XX=length (-01 =0,1m, -02=0,2m, -14=1,4m...)



LEDSTRIP NEON FRONT

IP67 5mt. DIM

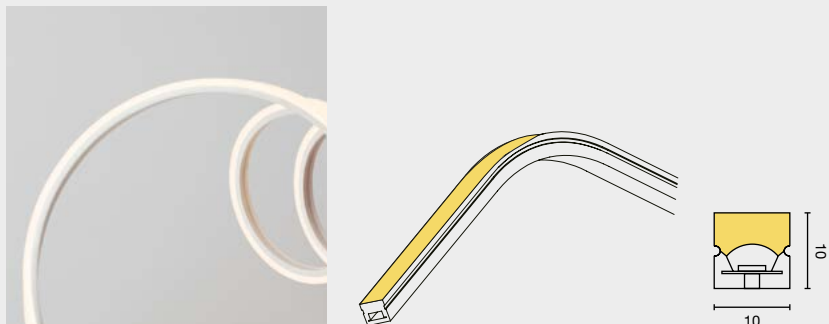

Ref	Power (W/m)	Color T°	lm output/m	IP	Cut
08047001	14W	2700K	470	67	125mm
08048001	14W	3000K	470	67	125mm

*Roll of 5m (500cm). You can order your own custom lenght every 10cm.
Cut to measure: ef. -XXX, where XX=length (-01 =0,1m, -02=0,2m, -14=1,4m...)

* Bobina de 5m (500cm) de longitud. Puede pedir su propia longitud personalizada cada 10cm
Corte a medida: ref. -XXX, donde XX=longitud (-01 =0,1m, -02=0,2m, -14=1,4m...)

ACCESSORIES



08040098 ALUMINIUM CLIP Clip de aluminio

LEDSTRIP NEON SIDE

IP67 5mt. DIM

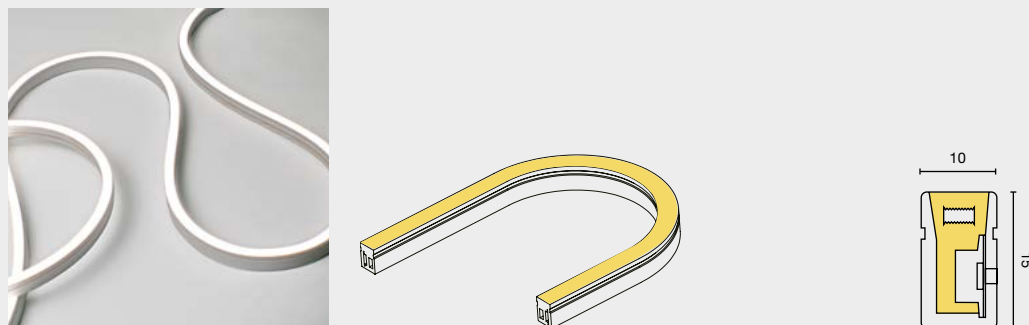

Ref	Power (W/m)	Color T°	lm output/m	IP	Cut
08045001	14W	2700K	1060	67	50mm
08046001	14W	3000K	1060	67	50mm

*Roll of 5m (500cm). You can order your own custom lenght every 10cm.
Cut to measure: ef. -XXX, where XX=length (-01 =0,1m, -02=0,2m, -14=1,4m...)

* Bobina de 5m (500cm) de longitud. Puede pedir su propia longitud personalizada cada 10cm
Corte a medida: ref. -XXX, donde XX=longitud (-01 =0,1m, -02=0,2m, -14=1,4m...)

ACCESSORIES



08040099 ALUMINIUM CLIP Clip de aluminio



LEDSTRIP PROFILES

SURFACE PROFILES

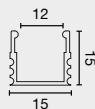

Ref	Finish	Long
08060101N	● Black	2000 mm
08060101B	○ White	2000 mm
08060101	● Silver	2000 mm

Ref	Accessorie	Finish
08060204N	End cap (2 pcs)	● Black
08060204B	End cap (2 pcs)	○ White
08060204	End cap (2 pcs)	● Silver

SURFACE PROFILES 8MM



Ref	Finish	Long
08080101N	● Black	2000 mm
08080101B	○ White	2000 mm
08080101	● Silver	2000 mm

Ref	Accessorie	Finish
08080204N	End cap (2 pcs)	● Black
08080204B	End cap (2 pcs)	○ White
08080204	End cap (2 pcs)	● Silver

SURFACE PROFILES 45°

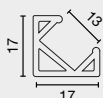
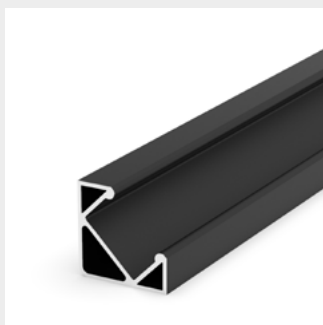

Ref	Finish	Long
08050101N	● Black	2000 mm
08050101B	○ White	2000 mm
08050101	● Silver	2000 mm

Ref	Accessorie	Finish
08050204N	End cap (2 pcs)	● Black
08050204B	End cap (2 pcs)	○ White
08050204	End cap (2 pcs)	● Silver

RECESSED PROFILES

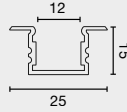
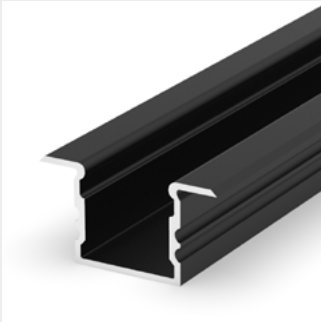

Ref	Finish	Long
08090101N	● Black	2000 mm
08090101B	○ White	2000 mm
08090101	● Silver	2000 mm

Ref	Accessorie	Finish
08070204N	End cap (2 pcs)	● Black
08070204B	End cap (2 pcs)	○ White
08070204	End cap (2 pcs)	● Silver

RECESSED PROFILES 8MM

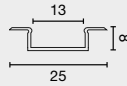
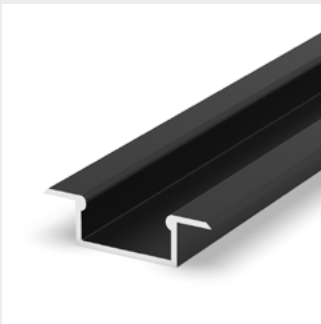

Ref	Finish	Long
08090111N	● Black	2000 mm
08090111B	○ White	2000 mm
08090111	● Silver	2000 mm

Ref	Accessorie	Finish
08090204N	End cap (2 pcs)	● Black
08090204B	End cap (2 pcs)	○ White
08090204	End cap (2 pcs)	● Silver

OPAL DIFFUSER



Ref	Long
0806202	2000 mm

TRANSPARENT DIFFUSER



Ref	Long
0806203	2000 mm

CLIPS



08050105 ● Surface profile clip 45°



08060105 ● Surface & 15mm recessed clip



Light Colour
Control de luz



Sunrise & Sunset
Amanecer y atardecer



Calendar & Timer
Calendario y Temporizador



Colour Color T°
Color Color T°



Grouping
Agrupación



Scenes
Escenas



Animations
Animaciones



Gallery
Galería



Daylight Sensor
Sensor de luz diurna



Occupancy Sensor
Sensor de ocupación

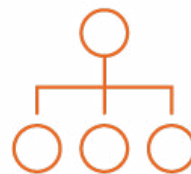

Control Hierarchy
Jerarquía de control

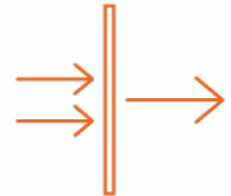

Gateway
Entrada

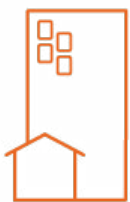

Scalability
Escalabilidad



Synchronization
Sincronización



Elements
Elementos



Parameters
Parámetros

This range of control elements offers customized solutions to optimize specific environments. Easily create dynamic spaces and energy efficient through control of lighting.



CASAMBI
SMART
LIGHTING

Esta gama de elementos de control ofrece soluciones personalizadas para optimizar entornos específicos. Crea fácilmente espacios dinámicos y eficientes desde el punto de vista energético mediante el control de la iluminación.

Switch & Controls

Switch for CASAMBI installations control



97534

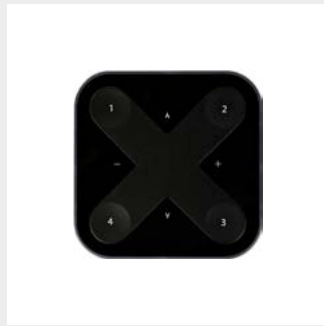

97533

Allows dimming, calling scenes, controlling groups, all lamps and sequences. Works with Casambi APP and Casambi Models. Black or white colour. Lithium CR2430 battery, duration 2-5 years. Open range 60 metres. 4 general purpose buttons (scenes, individual, groups, sequences) plus 2 regulation buttons and 2 other buttons programmable by the Casambi APP.

Permite regular, llamar a escenas, controlar grupos, todas las lámparas y secuencias. Funciona con la APP de Casambi y Modelos Casambi. Color negro o blanco. Pila CR2430 de Litio, duración 2-5 años. Alcance en abierto 60 metros. 4 botones de propósito general (escenas, individual, grupos, secuencias) más 2 botones de regulación y otros 2 botones programables por la APP de Casambi.

Switch 55

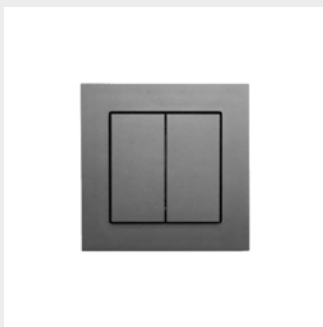

97536 Matt Anthracite Antracita Mate

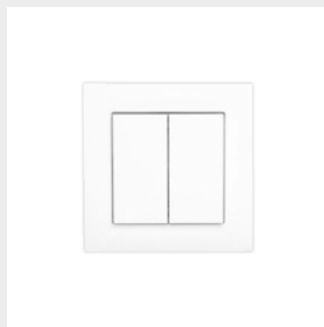

97537 Matt White Blanco Mate

4-channel bluetooth wireless push button with 2 keys. Completely autonomous (no battery or power supply), it works by mechanical impulses. It sends a radio signal thanks to the energy released when the keys are pressed and requires no maintenance.

Pulsador inalámbrico bluetooth de 4 canales mediante 2 teclas. Completamente autónomo (sin pila ni alimentación), funciona mediante impulsos mecánicos. Envía una señal de radio gracias a la energía liberada durante las pulsaciones de las teclas y no requiere mantenimiento.

Sensors

Recessed Sensor

Surface Sensor



97542



97543

Bluetooth light level and presence sensor in recessed or surface format. Through the CASAMBI App, it can be configured to activate scenes, luminaires, when it detects presence, according to illuminance or circadian scenes. Recommended installation height between 2.4 and 5m. Detection diameter between 5 and 7m.

Sensor bluetooth de nivel de luz y presencia en formato de empotrar o superficie. A través de la App de CASAMBI se puede configurar para activar escenas, luminarias, cuando detecte presencia, según la iluminancia o escenas circadianas. Altura de instalación recomendada entre 2,4 y 5m. Diámetro de detección entre 5 y 7m.

Auxiliary Devices

CBU-DCS Bluetooth DALI controller



97530

CBU-DCS is a Bluetooth controllable, Casambi enabled DALI controller. CBU-DCS does not have its own power supply. Instead, it is powered directly from a DALI bus.

CBU-DCS es un controlador DALI controlado por Bluetooth y habilitado por Casambi. CBU-DCS no tiene su propia fuente de alimentación. En su lugar, se alimenta directamente de un bus DALI.

Dimming for LED strips



97538

Dimming by CASAMBI for LED strips. 4 output channels. Max. total current 6 Ampere. Without push button input.

Regulación por CASAMBI para tiras LED. 4 canales de salida. Corriente máxima en total 6 Amperios. Sin entrada de pulsador.

CASAMBI to DALI converter



97531

Built-in 120mA DALI source. Broadcast output, 4 groups, DT8 or RGBW. To control up to 60 DALI luminaires all at the same time.

Fuente DALI integrada de 120mA. Salida en Broadcast, 4 grupos, DT8 o RGBW. Para controlar hasta 60 luminarias DALI todas a la vez.

Casambi Repeater Module



97532

With this module the range of the Bluetooth signal can be easily increased. Con este módulo se puede aumentar fácilmente el alcance de la señal Bluetooth.

Plug & Play – Switch



97540

Smart plug adapter for luminaires and electrical appliances. High switching capacity – up to 3680 W.

Adaptador de enchufe inteligente para luminarias y aparatos eléctricos. Gran capacidad de conmutación: hasta 3680W.



97541

Timer-Casambi



97544

TIMER-CASAMBI is a device that allows to keep memory of Casambi timers for scenarios when power supply is missing or because of a temporarily black-out. TIMER-CASAMBI es un dispositivo que permite mantener la memoria de los temporizadores Casambi para los escenarios en los que falta la alimentación eléctrica o debido a un apagón temporal.

Casambi PWM4 IP65



97539

IP65 CBU-PWM4. CBU-PWM4 en formato IP65.

Dali elements

Dali Touchpanel Basic C



97545

Capacitive touch panel with glass screen. Allows switching on, off and dimming of up to 3 groups or scenes of luminaires. Powered by DALI bus.

Panel táctil capacitivo con pantalla de cristal. Permite el encendido, apagado y regulación de hasta 3 grupos o escenas de luminarias. Alimentación por bus DALI.

Dali Touchpanel Basic TW



97546

Allows easy control of Tuneable White luminaires via DALI protocol. Permite controlar fácilmente las luminarias Tuneable White mediante protocolo DALI.

Dali USB Programmer



97547

USB interface module for DALI system. Accessory for connecting software tools for addressing, programming and parameterisation of DALI installations and Faro Barcelona devices.

Módulo interfaz USB para sistema DALI. Accesorio para conectar herramientas software para direccionamiento, programación y parametrización de instalaciones DALI y dispositivos Faro Barcelona.

Dali PS1 Power Supply



97548

4W DALI power supply for stand-alone mounting, Accessory for supplying 200mA to DALI devices or control modules without their own standard power supply. Powered at 230-240V; 50/60Hz.

Alimentador DALI de 4W para montaje independiente, Accesorio para suministrar 200mA a dispositivos DALI o módulos de control sin su propia fuente de alimentación estándar. Alimentado a 230-240V; 50/60Hz.

Recessed Dali Sensor



97549

Light level and presence sensor using DALI protocol. Recessed and surface mounting format. Allows simple switching on, switching off and dimming of individual luminaires, groups of luminaires or scenes, either by presence or brightness detection. Power supply via DALI bus.

Sensor de nivel de luz y presencia mediante protocolo DALI. Formato de empotrar y superficie. Permite encender, apagar y regular de forma simple luminarias individuales, grupos de luminarias o escenas, ya sea por detección de presencia o luminosidad. Alimentación mediante Bus DALI.

Surface Dali Sensor



97550

Today's technology makes it possible to integrate thousands of luminaires and control functions into a single system based on a DALI control network or even centralise it in a BMS system. At Faro Barcelona we have concentrated all our experience and knowledge on simple solutions helping to find the necessary control elements to customise an installation.

Despite the complexity and size of the lighting installations, only a few components are needed to manage the entire system: Luminaires with DALI driver, DALI sensors (multisensors), DALI pushbuttons, DALI buttons, DALI Bus feeder and routers as a control unit.

La tecnología actual permite integrar miles de luminarias y funciones de control en un solo sistema basado en una red DALI de control o incluso centralizarlo en un sistema BMS. En Faro Barcelona hemos concentrado toda nuestra experiencia y conocimientos en soluciones simples ayudando a encontrar los elementos de control necesarios para personalizar una instalación.

A pesar de la complejidad y el tamaño de las instalaciones de iluminación, solo se necesitan algunos componentes para gestionar todo el sistema: Luminarias con driver DALI, sensores (multisensores) DALI, pulsadores DALI, botonas DALI, alimentador de Bus DALI y routers como unidad de control.

DALI and DALI-2 are open lighting standards. It is a digital protocol used worldwide to control lighting components, it allows to transfer information such as lighting commands, fault data, consumption and diagnostics between different devices.



SMART LIGHTING



DALI y DALI-2 son estándares abiertos de iluminación. Es un protocolo digital usado en todo el mundo para controlar componentes de iluminación, permite transferir información como los comandos de iluminación, los datos de fallos, consumos y los diagnósticos entre distintos dispositivos.

Recommended Drivers





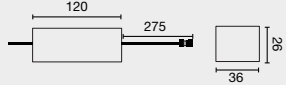
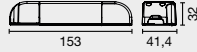

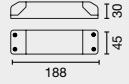
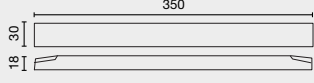
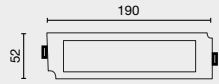
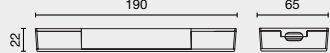
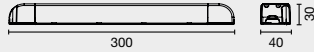
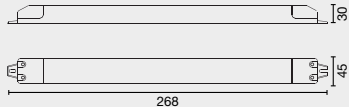
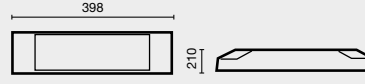
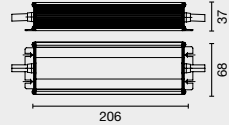
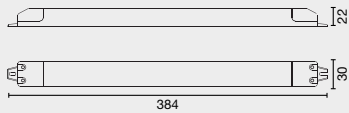







Driver	Model	Control System	Power	mA	Units
98310235	TROOP	ON/OFF 220-240V	2W	700mA	1-15 units
98310210	TROOP	TRIAC	2W	700mA	2-4 units
98310235D	TROOP	DALI	2W	700mA	1-15 units
98310538	TROOP	CASAMBI	2W	700mA	4-16 units
98310235	TROOP	ON/OFF 220-240V	3x2W	700mA	1-5 unit
98310220LC	TROOP	TRIAC	3x2W	700mA	2-3 units
98310235D	TROOP	DALI	3x2W	700mA	1-5 units
98310538	TROOP	CASAMBI	3x2W	700mA	2-5 units
98310235	TROOP	ON/OFF 220-240V	5x2W	700mA	1-3 units
98310210	TROOP	TRIAC	5x2W	700mA	1 unit
98310235D	TROOP	DALI	5x2W	700mA	1-3 units
98310538	TROOP	CASAMBI	5x2W	700mA	1-3 units
98310235	TROOP	ON/OFF 220-240V	4x2W	700mA	1-3 units
98310210	TROOP	TRIAC	4x2W	700mA	1 unit
98310235D	TROOP	DALI	4x2W	700mA	1-3 units
98310538	TROOP	CASAMBI	4x2W	700mA	1-3 units
98310235	TROOP	ON/OFF 220-240V	10x2W	700mA	1 unit
98310236C	TROOP	TRIAC	10x2W	700mA	1 unit
98310235D	TROOP	DALI	10x2W	700mA	1 unit
98310538	TROOP	CASAMBI	10x2W	700mA	1 unit
98310620	NANO COLIN	ON/OFF 220-240V	7W	200mA	1 unit
98310509C	NANO COLIN	TRIAC	7W	200mA	1 unit
98310136	NANO COLIN	ON/OFF 220-240V	13W	350mA	1 unit
98310114LC	NANO COLIN	TRIAC	13W	350mA	1 unit
98310136D	NANO COLIN	DALI	13W	350mA	1 unit
98310538	NANO COLIN	CASAMBI	13W	350mA	1 unit
98310336	MINI COLIN	ON/OFF 220-240V	18W	500mA	1 unit
98310321LC	MINI COLIN	TRIAC	18W	500mA	1 unit
98310336D/98310235D	MINI COLIN	DALI	18 / 25W	500 / 700mA	1 unit
98310538	MINI COLIN	CASAMBI	18 / 25W	500 / 700mA	1 unit
98310235	MINI COLIN	ON/OFF 220-240V	25W	700mA	1 unit
98310236C	MINI COLIN	TRIAC	25W	700mA	1 unit
98310235	COLIN	ON/OFF 220-240V	24W	700mA	1 unit
98310236C	COLIN	TRIAC	24W	700mA	1 unit
98310235D/98310536	COLIN	DALI	24 / 36W	700 / 1050mA	1 unit
98310538	COLIN	CASAMBI	24 / 36W	700 / 1050mA	1 unit

Driver	Model	Control System	Power	mA	Units
98310444	COLIN	ON/OFF 220-240V	36W	1050mA	1 unit
98310321LC	COLIN	TRIAC	36W	1050mA	1 unit
98111020	COLIN QR-111	ON/OFF 220-240V	20W	12V	1 unit
98312070	COLIN QR-111	TRIAC	70W	12V	MAX. 4 lamp.
98310336	OPTIC MINI	ON/OFF	18W	500mA	1-15 units
98310321 LC	OPTIC MINI	TRIAC	18W	500mA	2-4 units
98310336D/98310235D	OPTIC MINI	DALI	18 / 25W	500 / 700mA	1-15 units
98310235	OPTIC MINI	ON/OFF	25W	700mA	4-16 units
98310236C	OPTIC MINI	TRIAC	25W	700mA	1-5 unit
98310538	OPTIC MINI	CASAMBI	18 / 25W	500 / 700mA	2-3 units
98310235	OPTIC	ON/OFF	24W	700mA	1-5 units
98310236C	OPTIC	TRIAC	24W	700mA	2-5 units
98310235D/98310536	OPTIC	DALI	24 / 36W	700 / 1050mA	1-3 units
98310538	OPTIC	CASAMBI	24 / 36W	700 / 1050mA	1 unit
98310444	OPTIC	ON/OFF 100-240V	36W	1050mA	1-3 units
98310321 LC	OPTIC	TRIAC	18W	1050mA	1-3 units
98310637	DEEP S	ON/OFF 220-240V	6W	200mA	1 unit
98310509C	DEEP S	TRIAC	6W	200mA	1 unit
98310136	DEEP S	ON/OFF 220-240V	11W	350mA	1 unit
98310114C	DEEP S	TRIAC	11W	350mA	1 unit
98310136D	DEEP S	DALI	11W	350mA	1 unit
98310538	DEEP S	CASAMBI	11W	350mA	1 unit
98310136	DEEP M	ON/OFF 220-240V	12W	350mA	1 unit
98310114C	DEEP M	TRIAC	12W	350mA	1 unit
98310336	DEEP M	ON/OFF 220-240V	18W	500mA	1 unit
98310321 LC	DEEP M	TRIAC	18W	500mA	1 unit
983100136D/98310336D	DEEP M	DALI	12 / 18W	350/500mA	1 unit
98310538	DEEP M	CASAMBI	12 / 18W	350/500mA	1 unit
98310336	DEEP L	ON/OFF 220-240V	18W	500mA	1 unit
98310321 LC	DEEP L	TRIAC	18W	500mA	1 unit
98310235	DEEP L	ON/OFF 200-240V	25W	700mA	1 unit
98310236C	DEEP L	TRIAC	25W	700mA	1 unit
98310444	DEEP L	ON/OFF 100-240V	39W	1050mA	1 unit
98310336D/98310235D/98310536	DEEP L	DALI	18 / 25 / 39W	500/700/1050mA	1 unit
98310538	DEEP L	CASAMBI	18 / 25 / 39W	500/700/1050mA	1 unit

24V Power Supply

98324012	Constant voltage power supply for 24V DC. Supplies up to 12W, 220-240V, 50/60Hz.	Fuente de alimentación de voltaje constante para 24V DC. Suministra hasta 12W, 220-240V, 50/60Hz.	
98324026	Constant voltage power supply for 24V DC. Supplies up to 26W, 220-240V, 50/60Hz. With protection rated at IP67.	Fuente de alimentación de voltaje constante para 24V DC. Suministra hasta 26W, 220-240V, 50/60Hz. Con protección clasificada en IP67.	
98324030	Constant voltage power supply for 24V DC. Supplies up to 30W, 220-240V, 50/60Hz.	Fuente de alimentación de voltaje constante para 24V DC. Suministra hasta 30W, 220-240V, 50/60Hz.	
98324031	Constant voltage power supply for 24V DC. Supplies up to 30W, 220-240V, 50/60Hz. With protection rated at IP67.	Fuente de alimentación de voltaje constante para 24V DC. Suministra hasta 30W, 220-240V, 50/60Hz. Con protección clasificada en IP67.	
98324060	Constant voltage power supply for 24V DC. Supplies up to 60W, 220-240V, 50/60Hz.	Fuente de alimentación de voltaje constante para 24V DC. Suministra hasta 60W, 220-240V, 50/60Hz.	
98324099	Constant voltage power supply for 24V DC. Supplies up to 100W, 220-240V, 50/60Hz.	Fuente de alimentación de voltaje constante para 24V DC. Suministra hasta 100W, 220-240V, 50/60Hz.	
98324100	Constant voltage power supply for 24V DC. Supplies up to 100W, 220-240V, 50/60Hz. With protection rated at IP67.	Fuente de alimentación de voltaje constante para 24V DC. Suministra hasta 100W, 220-240V, 50/60Hz. Con protección clasificada en IP67.	
98324100D	Constant voltage power supply for 24V DC. Supplies up to 100W, 220-240V, 50/60Hz. Regulación Dali.	Fuente de alimentación de voltaje constante para 24V DC. Suministra hasta 100W, 220-240V, 50/60Hz. Regulación Dali.	
98324120	Constant voltage power supply for 24V DC. Supplies up to 120W, 220-240V, 50/60Hz.	Fuente de alimentación de voltaje constante para 24V DC. Suministra hasta 120W, 220-240V, 50/60Hz.	
98324150	Constant voltage power supply for 24V DC. Supplies up to 160W, 220-240V, 50/60Hz.	Fuente de alimentación de voltaje constante para 24V DC. Suministra hasta 160W, 220-240V, 50/60Hz.	
98324150D	Constant voltage power supply for 24V DC. Supplies up to 150W, 220-240V, 50/60Hz. Dali.	Fuente de alimentación de voltaje constante para 24V DC. Suministra hasta 150W, 220-240V 50/60Hz. Dali.	
98324151	Constant voltage power supply for 24V DC. Supplies up to 150W, 220-240V, 50/60Hz. With protection rated at IP67.	Fuente de alimentación de voltaje constante para 24V DC. Suministra hasta 150W, 220-240V, 50/60Hz. Con protección clasificada en IP67.	
98324200	Constant voltage power supply for 24V DC. Supplies up to 200W, 100-240V, 50/60Hz.	Fuente de alimentación de voltaje constante para 24V DC. Suministra hasta 200W, 100-240V, 50/60Hz. Con protección clasificada en IP20	

Simbology

	Luminaires of insulation class I are provided with a connection for the earthing conductor (PE) and are not specially marked.	Las luminarias de la clase de aislamiento I están provistas de una conexión para el conductor de puesta a tierra (PE) y no están identificadas de forma especial.
	Luminaires with insulation class II	Luminarias con clase de aislamiento II
	Luminaires with insulation class III	Luminarias con clase de aislamiento III
 incl.	Driver included	Equipo electrónico incluido
 no incl.	Driver not included	Equipo electrónico no incluido
 2mt.	Cable meters	Metros de cable
 50.000hs L80/B10	LED lifetime	Vida útil LED
 20°	Cardanic orientation	Orientación cardánica
 355°	Vertical orientation degrees	Grados de orientación vertical
 355°	Horizontal orientation degrees	Grados de orientación horizontal
 30°	Vertical orientation degrees	Grados de orientación vertical
 30°	Vertical orientation degrees	Grados de orientación vertical
 850°C	Compliance of incandescent wire regulatory	Cumplimiento de la normativa incandescente de alambre.
	Cut out	Agujero para empotrar
 MacAdam	MacAdam ellipses	Elipses de MacAdam
 DIM	Dimmers are devices used to vary the brightness of a light.	Los Dimmers son dispositivos utilizados para variar la intensidad de la luz.
 TW	Tunable White. Luminaires with variable colour temperature control from warm white to cool white.	Tunable White. Luminarias con control variable de la temperatura de color desde la luz blanca cálida hasta el blanco frío.
 UGR	Unified Glare Rating	Unified Glare Rating Índice de Deslumbramiento Unificado



FARO
BARCELONA

10

FARO
BARCELONA



Request visit



Showroom Barcelona
Princesa 52
08003 Barcelona
Spain
Tel +34932387373
showroom.barcelona@faro.es

Showroom Paris
7 Rue d'Uzès
75002 Paris
France
Tel +33745061553
showroom.paris@faro.es

Showroom Manila
699 Malate
1004 Metro, Manila
Philippines
Tel +63285595363
ldl_roxas@landlitephilcorp.com

Showroom Madrid
Velázquez 35 4ºD
28001 Madrid
Spain
Tel +34689583571
showroom.madrid@faro.es

Showroom Buenos Aires
Ven Street Center Local 30
Av. Italia 4950
1622 Dique Luján
Buenos Aires Argentina
Tel +5491171390813
showroom.argentina@faro.es

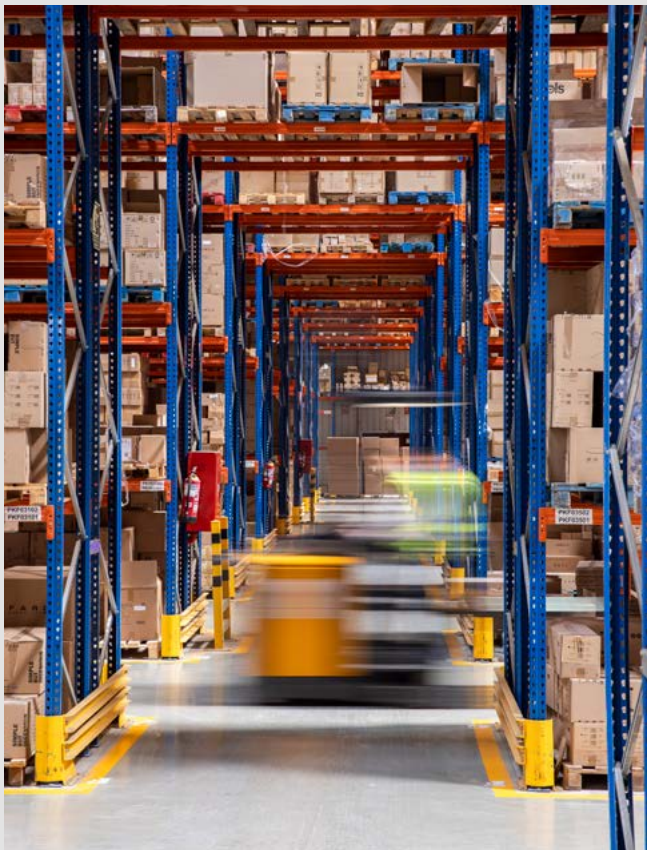

Logistics Headquarters
Dinámica 1 Pol. Ind. Santa Rita
08755 Castellbisbal
Spain
Tel +34937723949
info@faro.es

Logistics China
Room 1706-05, Glory International
Finance Center
25 Guicheng Road, Nanhai District
Foshan, Guangdong Province

Logistics US
135 West 41nd Street Suite 1002
10036 New York
USA

