

Colección Delta / Delta Collection Instrucciones para montaje / Assembling instructions

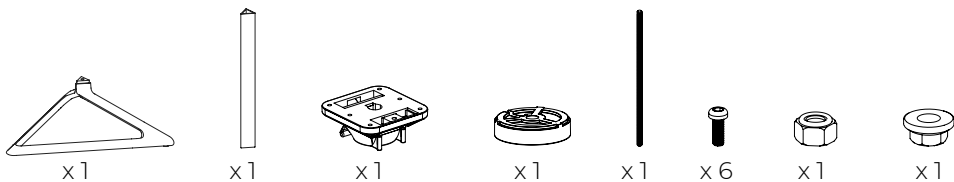

Soporte Abatible
Folding Mechanism

! Preste Atención a la Posición del Soporte
Place the folding mechanism
in the right position.

Disco Adaptador
Disk Adapter

! Tuerca Autoblocante M 10
M 10 Self-locking Nut

Tubo
Tube

Base
Base

Varilla Roscada M 10
M 10 Threaded Rod

! Tuerca con Collar M 10
Llave Hexagonal N° 17
M 10 Flange Nut
N° 17 Hexagonal Wrench

Pata de Nivelación
Leveling leg piece

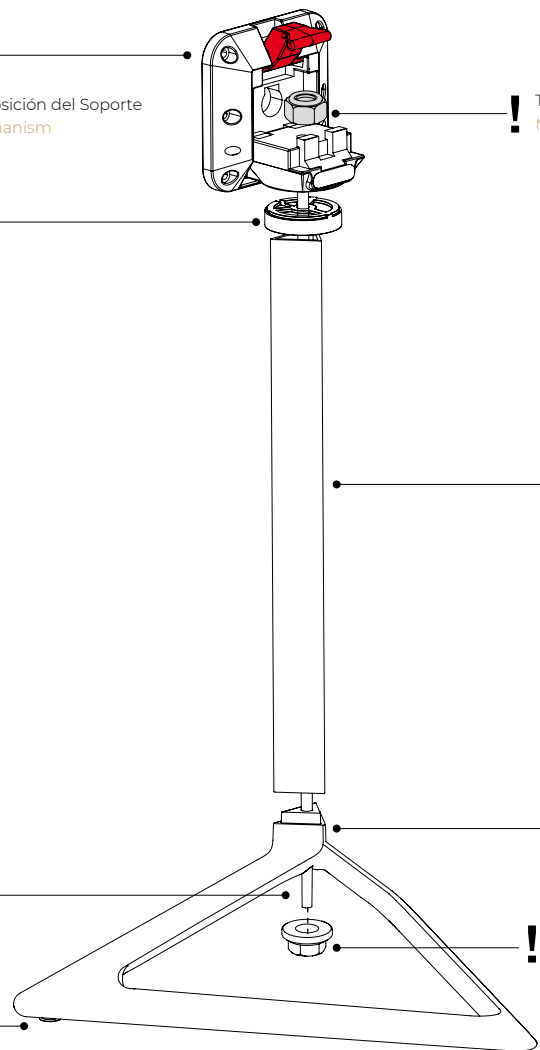

ASSEMBLY



Llave Allen N° 4
N° 4 Allen Key



M6 x 18 mm
M6 x 18 mm
x 6

Posiciones de los Tornillos en Tableros Cuadrados y Redondos
Screw Insertions in Square and Round Table Top

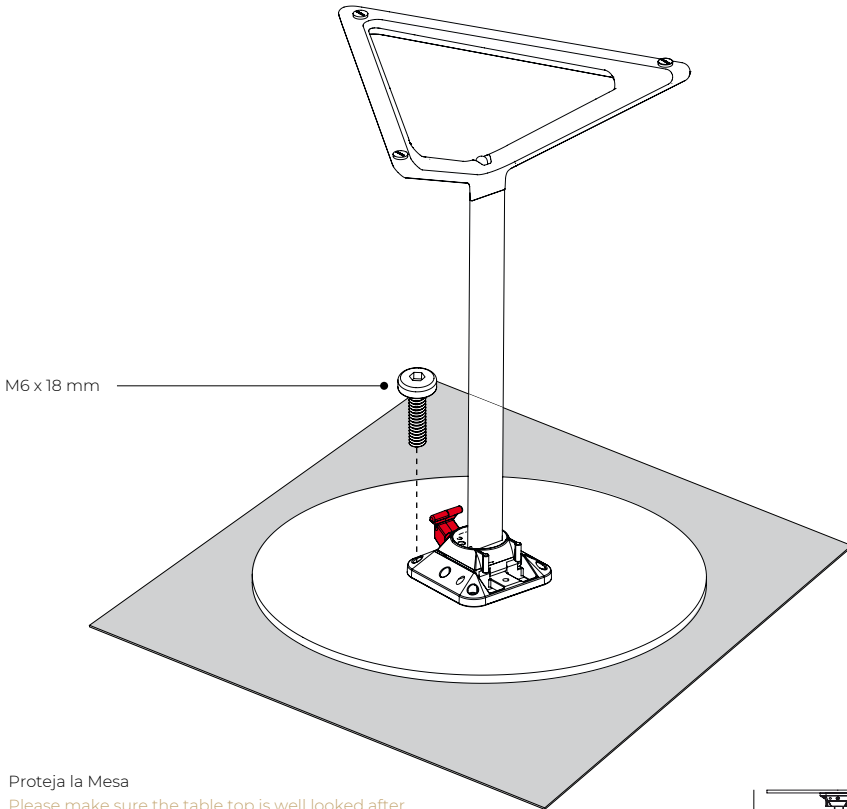
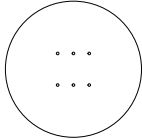
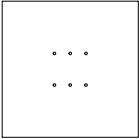

M6 x 18 mm

! Proteja la Mesa
Please make sure the table top is well looked after

50 cm
19 3/4"

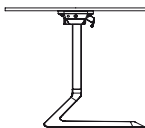

66006T

73 cm
28 3/4"

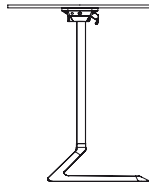

66007T

105 cm
41 1/4"

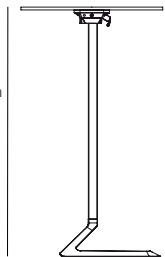

66008T