

outdoor

Livit Daybed / cama

Lievore Altherr Molina 2016

C488



Daybed with structure made of high resistance aluminum profile and legs of injected aluminum, finished with polyester powder. Possibility of customization through a wide variety of technical fabrics completely suitable for outdoor use. Removable upholstered cover.

Cama con estructura en perfilera de aluminio de alta resistencia y patas en inyección de aluminio, acabado en pintura de polvo de poliéster. Posibilidad de personalización mediante un amplia variedad de tejidos totalmente aptos para exteriores. Tapicería desenfundable.

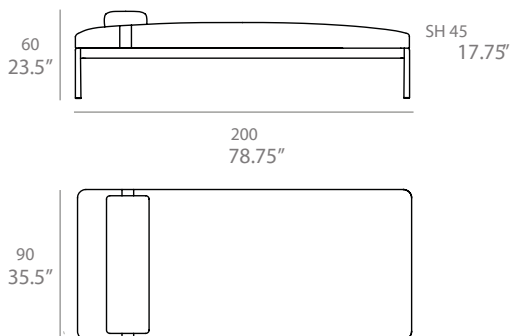

Shipment details

Qty	1 daybed (1 box)
Volume	0,95 m3 / 35.5 ft3
Gross weight	40 kg / 88 lb
Net weight	33 kg / 73 lb
Item dimensions (width x depth x height)	200 x 90 x 60 cm 78.75" x 35.5" x 23.5"
COM (1, 40 - 1,50 m / 54"-59")	3,3 m / 3.6 yd

outdoor

upholstered / tapizado

group 12 - heritage Sunbrella®



heritage papyrus

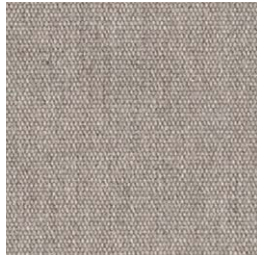

heritage ash



heritage moss



heritage leaf



heritage pumpkin



heritage garnet

group 12 - silvertex™

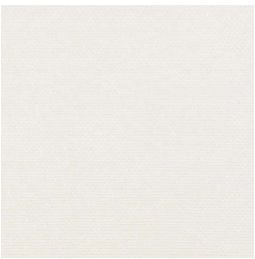

silvertex ice

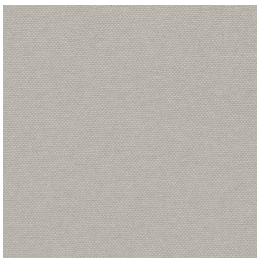

silvertex macadamia

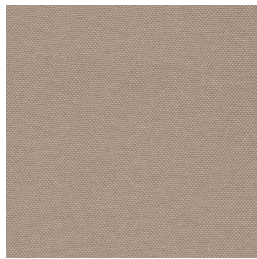

silvertex sandstone



silvertex taupe

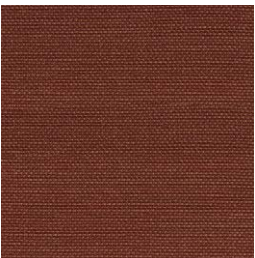

silvertex umber



silvertex teal



silvertex citrus

outdoor

upholstered / tapizado

group 12 - dolce Crevin®



dolce 07



dolce 16

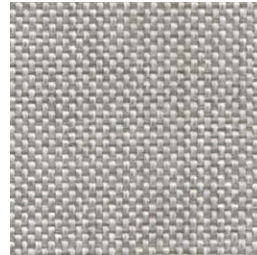

dolce 80

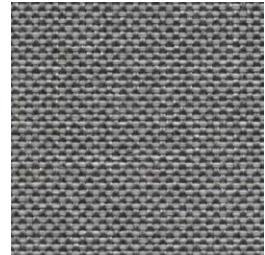

dolce 51



dolce 53

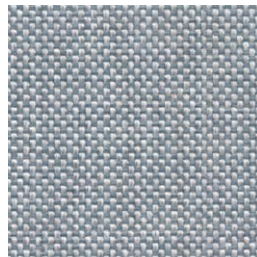

dolce 43

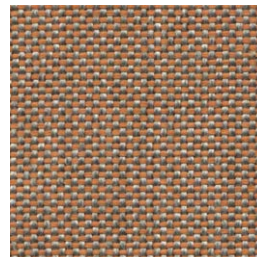

dolce 24



dolce 30

group 12 - strada Crevin®



strada 07

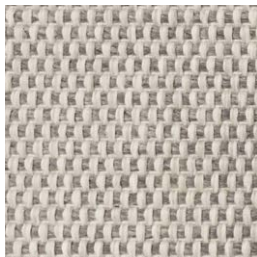

strada 75



strada 51



strada 83

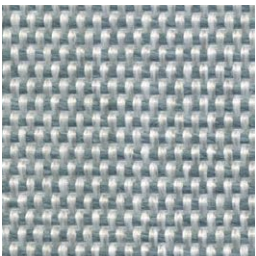

strada 43

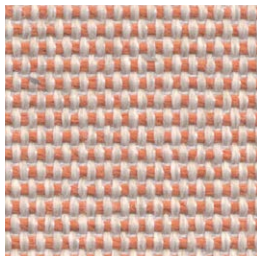

strada 29



strada 32

expormim

Expormim S.A.
Pol. Ind. Jaime I
46640 Moixent (Valencia) Spain
+34 962 295 144/5
export@expormim.com
www.expormim.com

Expormim USA LLC
(212) 204-8572
usa@expormim.com
www.expormim.com

3/5

outdoor

upholstered / tapizado

group 13 - bora bora Crevin®



bora bora 99



bora bora 07



bora bora 08

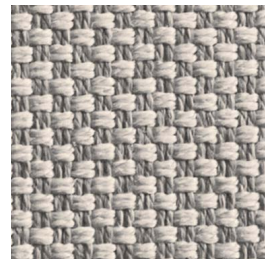

bora bora 11



bora bora 42



bora bora 47

group 13 - sling Sunbrella®

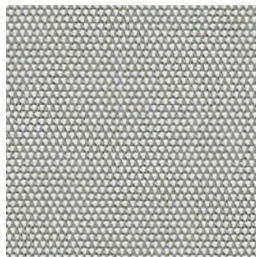

sling sailing seagull

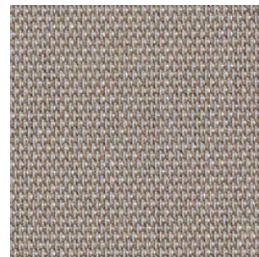

sling sailing space



sling logan graphite

expormim

Expormim S.A.
Pol. Ind. Jaime I
46640 Moixent (Valencia) Spain
+34 962 295 144/5
export@expormim.com
www.expormim.com

Expormim USA LLC
(212) 204-8572
usa@expormim.com
www.expormim.com

4/5

legs / patas

metallic finishes / metales



100 FT white
fine textured



102 FT light grey
fine textured



111 FT graphite
fine textured

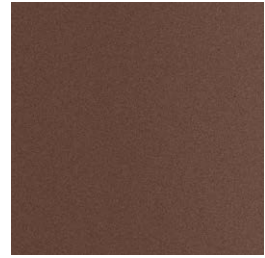

108 FT oxide
fine textured



109 FT champagne
fine textured



110 FT bronze
fine textured



113 FT sage
fine textured