

Palma

Odosdesign



EN

A collection of iconic coffee tables which look light and can be combined. This design can easily be customized as the top and support can be divided, and there is a wide range of finishes.

SP

Colección de mesitas combinables de apariencia icónica y liviana. Un diseño fácilmente customizable gracias a la subdivisión de su estructura entre sobre y soporte y a una amplia variedad de acabados.

FR

Collection de petites tables basses combinables avec un aspect iconique et léger. Un design facilement personnalisable grâce à la subdivision de sa structure entre le plateau et le piètement et une grande variété de finitions.

DE

Palma ist eine Kollektion kombinierbarer Beistelltische mit ikonischem und leichtem Erscheinungsbild. Ein einfach anpassbares Design dank der Unterteilung in Tischplatte und Trägerstruktur und einer Vielzahl an Oberflächen.

RU

Коллекция знаковых и легко комбинируемых столиков. Дизайн, свободно адаптирующийся к любым требованиям, благодаря разделению его структуры на поверхность и оригинальное основание, а также благодаря широкому спектру отделки.

DIMENSIONS:

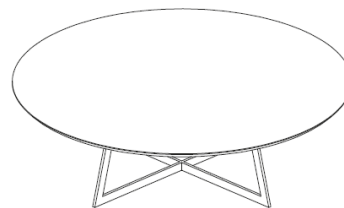
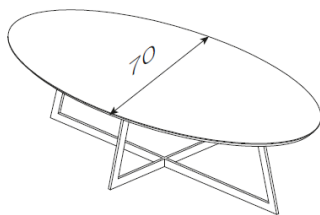
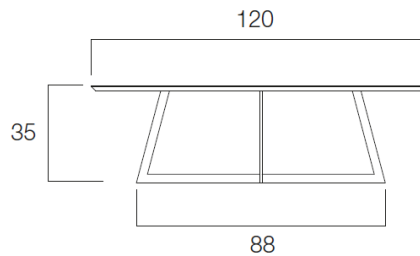
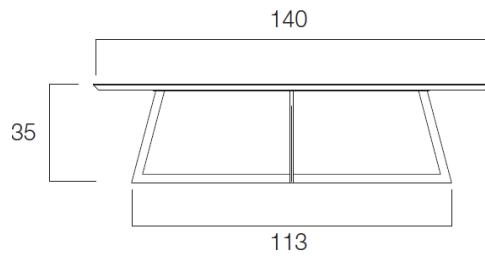
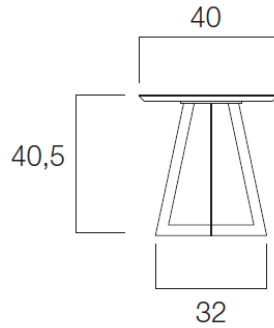
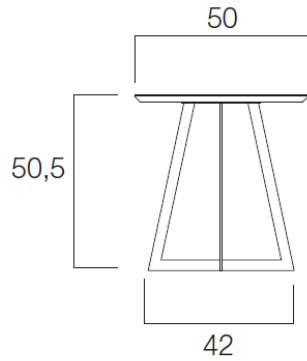

Cm	Inches
50 x 50 x 50	19,69 x 19,69 x 19,69
40 x 40 x 40	15,75 x 15,75 x 15,75
140 x 70 x 35	55,12 x 27,56 x 13,78
120 x 120 x 35	47,24 x 47,24 x 13,78

FINISHES:

TOP

Lacquers



White / Blanco / Blanc



Pearl grey / Gris Perla / Gris Perle



Foggy



Rain



Slate / Pizarra / Ardoise



Stone / Piedra / Stone



Sahara



Mocca



Mink / Visón / Vison



Gold



Terracota / Terre Cuite



Brick



Merlot



Taupe

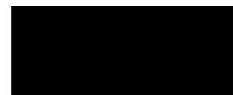

Black / Negro / Noir



Moss



Salvia



Whale blue / Azul Ballena / Bleu Baleine



Mustard / Mostaza / Moutarde



Navy

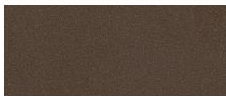

Coffee

Natural Veneers



European oak / Roble europeo / Chêne Européen



Leopard oak / Roble Leopard / Chêne Leopard



American walnut / Nogal Americano / Noyer Américain



Smoky oak / Roble Fumé / Chêne Fumé

Mobenia®

Ceramics



Hydra Argen



Blaze Dark



Kalos Bianco



Ferox



Concerto



Calacatta 6mm.



Urano 6mm.

Marble



Venato

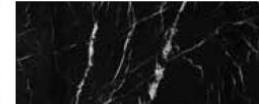

Markina

BASE

Lacquers



White / Blanco / Blanc



Pearl grey / Gris Perla / Gris Perle



Foggy



Rain



Slate / Pizarra / Ardoise



Stone / Piedra / Stone



Sahara



Mocca



Mink / Visón / Vison



Gold



Terracota / Terre Cuite



Brick



Merlot



Taupe



Black / Negro / Noir



Moss



Salvia



Whale blue / Azul Ballena / Bleu Baleine



Mustard / Mostaza / Moutarde



Navy

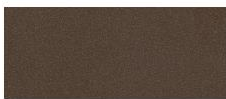

Coffee

DESIGNER:

Odosdesign



EN

Odosdesign is headed by Ana Segovia and Luis Calabuig, together with a multidisciplinary team of professionals from different fields.

Since 2005, we have worked side by side with international clients related to product design, which gives us experience and a specialized vision of the sector.

It is not only about being creative, but about doing it with a specific goal. That's why in Odosdesign we use design as a strategic tool to communicate and convey products, services or ideas, in a rigorous way and taking care of every detail.

SP

Al frente de Odosdesign estamos Ana Segovia y Luis Calabuig, junto con un equipo multidisciplinar de profesionales de diferentes campos.

Desde 2005 trabajamos codo a codo con clientes nacionales e internacionales afines al diseño de producto, lo que les otorga experiencia y una visión especializada del sector.

Odosdesign ayuda a identificar, articular y comunicar aquello que es excepcional de cada organización; todo para mostrar la mejor versión de cada empresa.

No se trata únicamente de ser creativo, sino de hacerlo con un objetivo concreto. Por eso en Odosdesign utiliza el diseño como una herramienta estratégica para comunicar y transmitir productos, servicios o ideas, de forma rigurosa y cuidando cada detalle.

FR

Pour diriger Odosdesign nous sommes Ana Segovia et Luis Calabuig avec une équipe multidisciplinaire de professionnels de différents secteurs.

Depuis 2005 nous travaillons en étroite collaboration avec des clients nationaux et internationaux proches au design de produit, ce qui nous donne une large expérience et une vision spécialisée du secteur.

Odosdesign peut vous aider à identifier et communiquer tout ce qui est exceptionnel dans votre organisation le tout pour vous montrer la meilleure version de votre entreprise.

Il ne s'agit pas uniquement d'être créatif, mais de le faire avec un objectif concret. C'est pour cela que Odosdesign utilise le design comme un outil stratégique pour communiquer et transmettre des produits, des services et des idées de façon rigoureuse et soignant chaque détail.

DE

Wir, Ana Segovia und Luis Calabuig, zusammen mit einem multidisziplinären Team von Fachleuten aus verschiedenen Bereichen, sind Odosdesign.

Seit 2005 arbeiten wir Seite an Seite mit nationalen und internationalen Kunden im Bereich Produktdesign. Somit verfügen wir über langjährige Erfahrung und einen fachspezifischen Überblick über diesen Marktbereich.

In Odosdesign helfen wir Ihnen, das Außergewöhnliche in Ihrer Organisation zu identifizieren, zu artikulieren und zu kommunizieren. All das dient dazu Ihr Unternehmen im besten Licht zu zeigen.

Es geht nicht nur darum, kreativ zu sein, sondern kreativ mit einem bestimmten Ziel zu sein. Deshalb setzen wir bei Odosdesign Design als strategisches Instrument ein, um Produkte, Dienstleistungen oder Ideen konsequent und mit Liebe zum Detail zu kommunizieren und zu vermitteln.

RU

Odosdesign возглавляем мы - Ана Сеговия и Луис Калабуиг вместе с многопрофильной командой профессионалов из разных областей.

С 2005 года мы работаем бок о бок с отечественными и международными клиентами, связанными с дизайном продукта, что дает нам опыт и специализированное видение сектора.

В Odosdesign мы поможем вам определить и сформулировать, что именно является исключительным в вашей организации; поможем вам показать лучшую версию вашей компании.

Речь идет не только о творчестве, но и о том, чтобы создавать что-то с конкретной целью. Именно поэтому в Odosdesign мы используем дизайн как стратегический инструмент для общения и представления продуктов, услуг или идей, неукоснительно заботясь о каждой детали.