

ESSENTIAL.

GENTLE.

FRONT.

PADI.

JOQUER

FRONT COLLECTION.

PADI COLLECTION.

JOQUER

JOQUER IS AN ARTISANAL AND METICULOUS COMPANY THAT HAS BEEN MANUFACTURING UPHOLSTERED FURNITURE FOR FORTY YEARS.



Our essence lies in the patient crafting of high-quality products, offering personalized solutions to our clients through complete control of the manufacturing process. For us, every space is unique, and every person is different. That's why the design of all our collections, both indoor and outdoor, is tailored to respond to four distinct lifestyles: Essential, Cozy, Singular, and New Classic. The distinctive character of each is, at the same time, united under a single design

philosophy, making all our products exude an unmistakable aesthetic serenity. Our furniture comes to life through three core values: accessible luxury, a valuable piece for everyday use, and timeless design. These three values feed off one another, each being the natural consequence of the other two. Details, comfort, and materiality truly matter to us. That's why our motto is "The unique everyday," the ability to enjoy the everyday as something exceptional.

Joquer est une entreprise artisanale et méticuleuse qui fabrique des meubles rembourrés depuis quarante ans.

Notre essence réside dans l'élaboration patiente de produits de haute qualité, offrant des solutions personnalisées à nos clients grâce à un contrôle total du processus de fabrication.

Pour nous, chaque espace est unique et chaque personne est différente. C'est pourquoi le design de toutes nos collections, tant intérieures qu'extérieures, est conçu pour répondre à quatre styles de vie distincts : Essential, Cozy, Singular et New Classic.

Le caractère distinctif de chacun est, en même temps, uni sous une seule philosophie de design, ce qui fait que tous nos produits dégagent une sérénité esthétique indéniable.

Nos meubles prennent vie à travers trois valeurs fondamentales : le luxe accessible, une pièce précieuse pour un usage quotidien, et un design intemporel. Ces trois valeurs se nourrissent mutuellement, chacune étant la conséquence naturelle des deux autres.

Les détails, le confort et la matérialité ont véritablement de l'importance pour nous. C'est pourquoi notre slogan est "Le quotidien unique", la capacité de profiter de l'ordinaire comme quelque chose d'exceptionnel.

Joquer es una empresa artesana y cuidadosa que lleva cuarenta años fabricando mobiliario tapizado. Nuestra esencia es la elaboración paciente de productos de mucha calidad, dando respuestas personalizadas a nuestros clientes desde un control total del proceso de fabricación.

Para nosotros, cada espacio es único y cada persona es diferente. Por eso, el diseño de todas nuestras colecciones, de interior y exterior, responde a cuatro estilos de vida: Essential, Cozy, Singular y New Classic.

El carácter diferenciador de cada uno está, al mismo tiempo, unido bajo una misma forma de entender el diseño, lo que hace que todos nuestros productos respiren una inconfundible serenidad estética.

Nuestros muebles se hacen realidad a partir de tres valores: ser un lujo accesible, ser una pieza valiosa para cada día y tener un diseño atemporal. Los tres se retroalimentan, cada uno es la consecuencia natural de los otros dos.

Los detalles, la comodidad y la materialidad nos importan de verdad. Por eso nuestro lema es "The unique everyday", el saber disfrutar de lo cotidiano como algo excepcional.

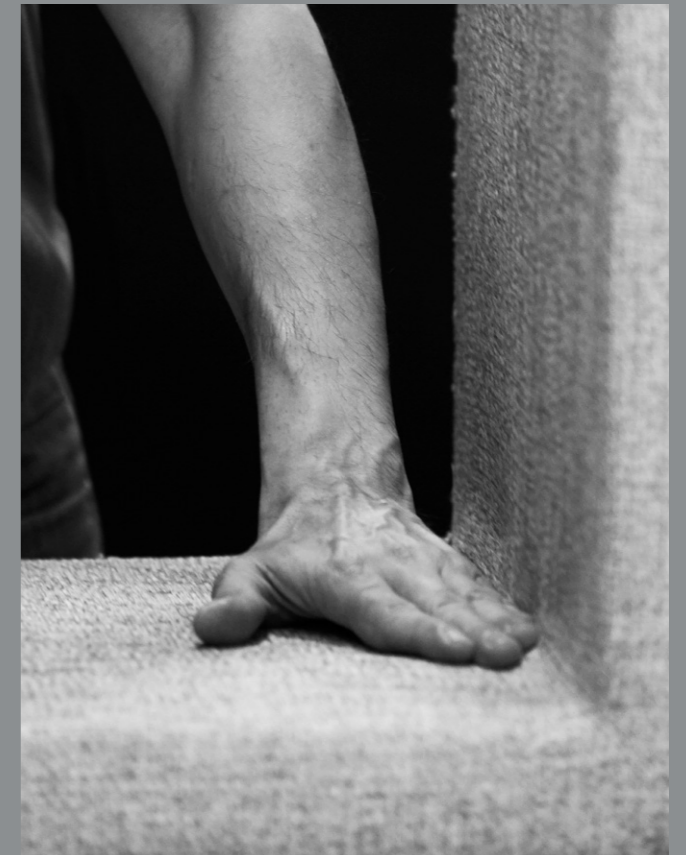

FRONT COLLECTION.



WITH ITS RECTILINEAR SHAPES AND CLEAN GEOMETRIES, FRONT IS A COLLECTION THAT HIGHLIGHTS VERSATILITY AND COMFORT, DESIGNED WITH VARIOUS MODULES THAT ALLOW FOR THE CREATION OF SOLUTIONS FOR ANY COMPACT SPACE.

The balance of proportions between the armrests, seat, and backrest is expressed through harmonious and light lines.

The collection offers two optional bases: elevated or floor standing. In the first option, the modules rest on four legs with a one-centimeter front view profile and a wide surface finished in an arch shape from the side view. The floor standing version conveys a warm, universal identity of revisited tradition.



Avec ses formes rectilignes et ses géométries épurées, la collection Front met en valeur la polyvalence et le confort, conçue avec différents modules permettant de créer des solutions pour tout type d'espace compact.

L'équilibre des proportions entre les accoudoirs, le siège et le dossier s'exprime à travers des lignes très harmonieuses et légères.

La collection propose deux bases optionnelles : suspendue ou au sol. Dans la version suspendue, les modules reposent sur quatre pieds d'un centimètre de section vus de face et sur une large surface finie en arc sur le profil latéral. La version au sol transmet une identité universelle chaleureuse d'une tradition revisitée.

Con sus formas rectilíneas y sus limpias geometrías, Front es una colección que pone en valor la versatilidad y la comodidad, diseñada con distintos módulos que permiten construir soluciones para cualquier tipología de espacio ajustado.

El equilibrio de proporciones tanto de brazo como de asiento y respaldo se expresa a través de líneas muy armoniosas y ligeras.

La colección tiene dos bases opcionales: suspendida o a suelo. En la primera, los módulos descansan sobre cuatro patas de sección de un centímetro en su vista frontal y una amplia superficie terminada en forma de arco en su visión lateral. La versión hasta el suelo transmite una cálida identidad universal de tradición revisitada.



PADI COLLECTION.



A collection of light and airy occasional tables supported by three legs that form an arch, seamlessly integrating the metal base with the top, available in wood, natural or technical stone. With an organic design, the legs create a very lightweight appearance from the front view, contrasting with a broader profile from the side. The design of this base connects with the language of the legs from the elevated version of the Front sofa.

Une collection de tables basses et d'appoint légères et aériées soutenues par trois pieds qui forment une arche, intégrant parfaitement la base en métal avec le plateau, disponible en bois, pierre naturelle ou technique. Avec un design organique, les pieds créent une apparence très légère en vue frontale, contrastant avec un profil plus large en vue latérale. Le design de cette base se connecte avec le langage des pieds de la version suspendue du canapé Front.

Colección de mesitas auxiliares de imagen muy ligera y aérea sustentadas sobre tres patas que dibujan un arco integrando la base metálica con el sobre de madera, piedra natural o técnica. Con un lenguaje orgánico el diseño de las patas define una vista frontal muy liviana en contraste con la visión lateral, más anchas. El diseño de esta base conecta con el lenguaje de las patas del sofá Front en su versión suspendida.

MARIO RUIZ. THE DESIGNER.



Design that is pristine and prosaic. This motif runs through the work of Spanish designer Mario Ruiz (Alicante, 1965), who has built a cosmopolitan career rooted in the vocation to create timeless designs. Every one of his projects, which comprise furniture, lighting and technology design and art direction, is exactly as it seems: objects whose clean, soft, coherent lines are an invitation for use. Intense work has gone into expressing their purpose and careful attention into their details. Among the over 50 awards he has garnered, the Spanish National Design Prize, Best of Neocon, Metropolis and Wallpaper Magazine awards stand out.

Un design épuré et familier. C'est le fil conducteur de l'oeuvre du designer Mario Ruiz (Alicante, 1965), qui a bâti sa carrière internationale sur la conception d'ouvrages qui perdurent dans le temps. Chacun de ses projets, englobant la conception de meubles, d'éclairage et de solutions technologiques et artistiques est fidèle à son apparence : des objets aux lignes épurées, douces et harmonieuses qui invitent à être utilisés. Un travail intense a été réalisé afin d'en dévoiler la finalité et un grand soin a été apporté aux détails. Tout au long de son parcours, il s'est vu décerné plus de 50 récompenses parmi lesquelles le National Design Award 2016 et les prix du Best of Neocon, Metropolis et Wallpaper Magazine.

El diseño claro y cotidiano. Este es el argumento que guía el trabajo del diseñador Mario Ruiz (Alicante, 1965), constructor de una trayectoria cosmopolita sembrada con la vocación de conseguir diseños que perduren en el tiempo. Cada uno de sus proyectos, que abarcan el diseño de mobiliario, iluminación, tecnología y la dirección de arte es lo que se ve: objetos que invitan a ser utilizados desde sus formas limpias y comprensibles. En ellos hay un trabajo intenso de resolver la identidad de cada uso y una cuidadosa atención por el detalle. Entre los más de 50 premios que ha recibido figuran el Premio Nacional de Diseño 2016, Best of Neocon, Metropolis y Wallpaper Magazine.

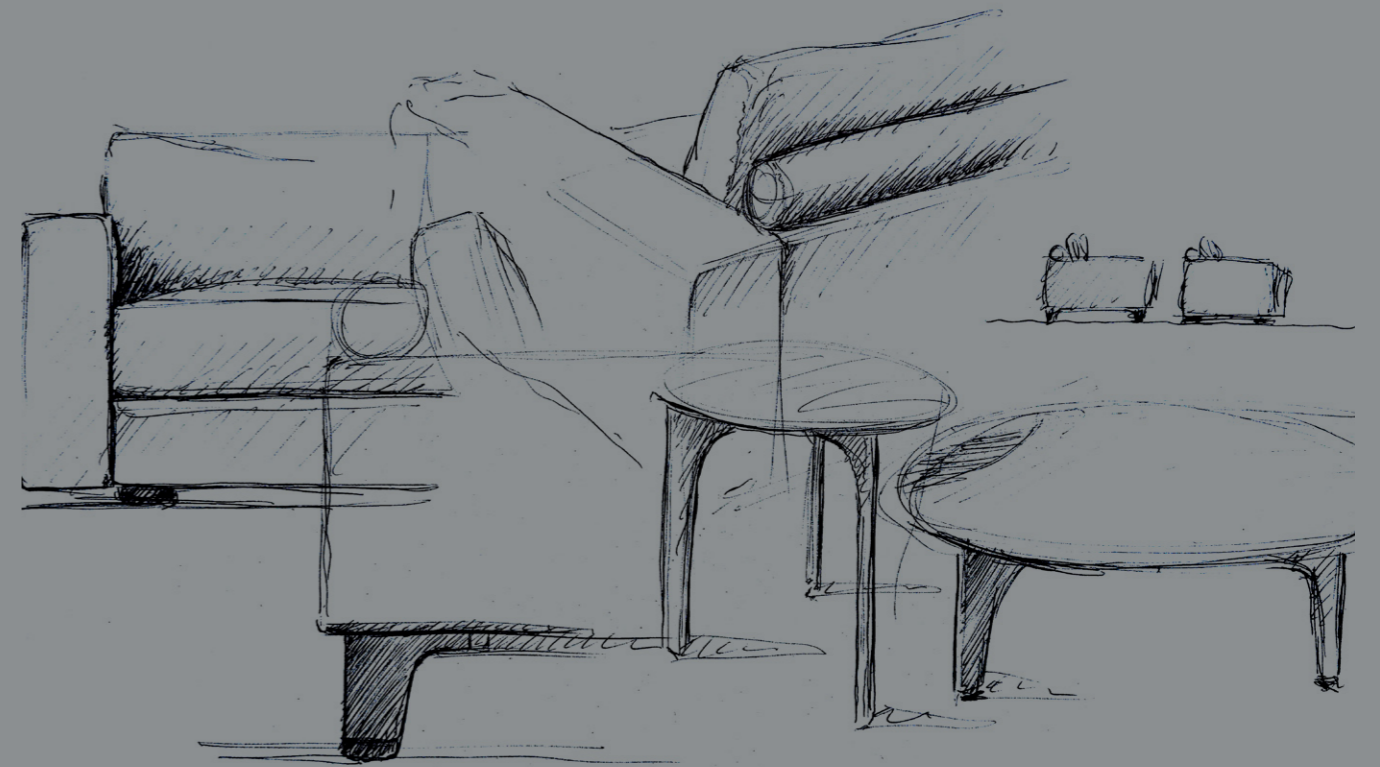



FROSI195BT, FROPT96X96BT
Fabric / Tissu / Tejido: Lario 38, Sancho 30

PADCRT37, PADCRT102
Natural stone / Pierre naturelle / Piedra natural: Emperador.
Wood / Bois / Madera: American walnut, noyer américain, nogal americano.



FROSI195BT, FROPI91X96BT, FROSD107BT, FROPT96X96BT
Fabric / Tissu / Tejido: Lario 38, Sancho 30

PADCRT37, PADCRT50, PADCRT102
Natural stone / Pierre naturelle / Piedra natural: Emperador, Carrara.
Wood / Bois / Madera: American walnut, noyer américain, nogal americano.

FLOB78
Fabric / Tissu / Tejido: Sancho 03



FROSI195BT, FROPI91X96BT, FROSD107BT
Fabric / Tissu / Tejido: Lario 38



FROSI195BT
Fabric / Tissu / Tejido: Lario 38



FLOB78
Fabric / Tissu / Tejido: Jurga 05

FROSI195BT, FRORIOD277BT
Fabric / Tissu / Tejido: Sancho 30

PADCRT37, PADCRT50, PADCRT102
Natural stone / Pierre naturelle / Piedra natural: Emperador, Carrara.
Wood / Bois / Madera: Dark stained oak, chêne teinte foncée, roble teñido oscuro.



FROSI195BT, FRORIOD277BT
Fabric / Tissu / Tejido: Sancho 30
PADCRT102
Wood / Bois / Madera: Dark stained oak, chêne teinte foncée, roble teñido oscuro.

FRORIOD277BT
Fabric / Tissu / Tejido: Sancho 30



FROS274BT
Fabric / Tissu / Tejido: Lario 38

PADCRT37, PADCRT50, PADCRT102
Natural stone / Pierre naturelle / Piedra natural: Carrara.
Wood / Bois / Madera: American walnut, noyer américain, nogal americano.



FROS274BS
Fabric / Tissu / Tejido: Caliu 05

PADCRT37, PADCRT50, PADCRT102
Natural stone / Pierre naturelle / Piedra natural: Carrara, Marquina.





ETHB86RBGC
Fabric / Tissu / Tejido: Clunis 779.028

FROCLI107BT, FROS0179BT, FROSDRI289BT
Fabric / Tissu / Tejido: Lario 38

PADCRT37, PADCRT50, PADCRT102
Natural stone / Pierre naturelle / Piedra natural: Emperador, Carrara.
Wood / Bois / Madera: Dark stained oak, chêne teinte foncée, roble teñido oscuro.



FROCLD107BS, FROSI195BS
Fabric / Tissu / Tejido: Caliu 05

PADCRT37, PADCRT50, PADCRT102
Natural stone / Pierre naturelle / Piedra natural: Carrara.
Wood / Bois / Madera: Dark stained oak, chêne teinte foncée, roble teñido oscuro.



FROCLD107BS, FROS0179BS, FROSIRD289BS
Fabric / Tissu / Tejido: Caliu 05

PADCRT37, PADCRT50, PADCRT102
Natural stone / Pierre naturelle / Piedra natural: Emperador, Carrara.
Wood / Bois / Madera: American walnut, noyer américain, nogal americano.

ETHB86RBGC
Fabric / Tissu / Tejido: Elmobaltique 33280

Floor standing. Ras du sol.
Base a suelo.
Backrest cushion height.
Hauteur du coussin du dossier.
Altura de cojín de respaldo.

Low (74 cm - 29.13")



Elevated base. Base suspendue.
Base suspendida.
Backrest cushion height.
Hauteur du coussin du dossier.
Altura de cojín de respaldo.

Low (74 cm - 29.13")



Floor standing. Ras du sol.
Base a suelo.
Backrest cushion height.
Hauteur du coussin du dossier.
Altura de cojín de respaldo.

Standard (81 cm - 31.89")



Elevated base. Base suspendue.
Base suspendida.
Backrest cushion height.
Hauteur du coussin du dossier.
Altura de cojín de respaldo.

Standard (81 cm - 31.89")



Floor standing. Ras du sol.
Base a suelo.
Backrest cushion height.
Hauteur du coussin du dossier.
Altura de cojín de respaldo.

Premium (91 cm - 35.83")



Elevated base. Base suspendue.
Base suspendida.
Backrest cushion height.
Hauteur du coussin du dossier.
Altura de cojín de respaldo.

Premium (91 cm - 35.83")



Top diameter and table height.
Diamètre du plateau et hauteur
de la table. Diámetro del sobre
y altura de la mesa.

(ø 102 cm x H 30 cm - ø 40.16"
H 11.81")



Top diameter and table height.
Diamètre du plateau et hauteur
de la table. Diámetro del sobre
y altura de la mesa.

(ø 50 cm x H 36 cm - ø 19.69"
H 14.17")



Top diameter and table height.
Diamètre du plateau et hauteur
de la table. Diámetro del sobre
y altura de la mesa.

(ø 37 cm x H 42 cm - ø 14.57"
H 16.54")



INFO.

TECHNICAL SPECIFICATIONS.

INNER CONSTRUCTION CONSTRUCTION INTERIEURE CONSTRUCCIÓN INTERIOR

FRONT SOFA SECTION, ELEVATED BASE.
SECTION CANAPÉ FRONT, BASE SUSPENDUE.
SECCIÓN SOFÁ FRONT, BASE SUSPENDIDA.

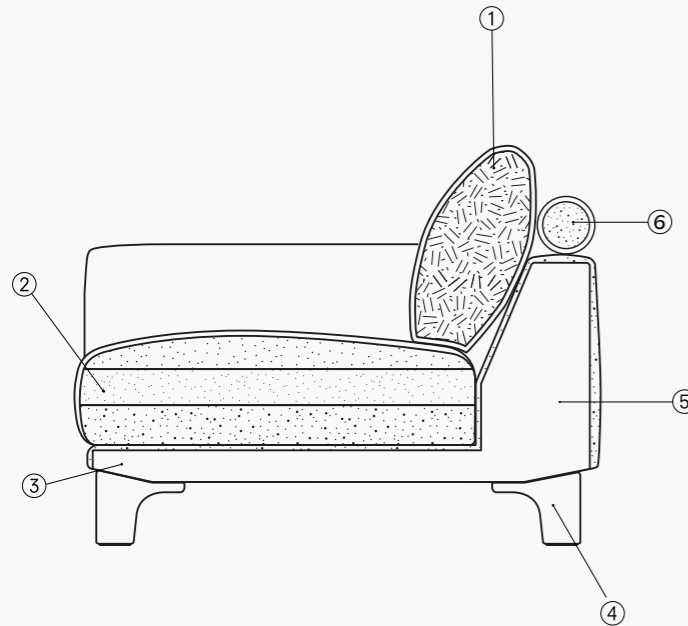

- ① Back cushion with polyester silicone fibre.
Coussin de dossier réalisé avec fibre de polyester silicone.
Cojín de respaldo en fibra de poliéster siliconada.
- ② Seat in different polyurethane foam densities with surface padding in polyester fibre.
Coussin de l'assise réalisé dans différentes densités de mousse de polyuréthane, matelassé en surface avec du fibre de polyester.
Cojín de asiento en distintas densidades de espuma de poliuretano acolchado en la superficie con fibra de poliéster.
- ③ Wood Frame.
Châssis en bois.
Bastidor de madera.
- ④ LDPE feet.
Pieds en PEBD.
Pies en LDPE.
- ⑤ Structure covered with flexible cold shaped polyurethane foam and polyester fibre.
Structure recouvert de mousse de polyuréthane souple à froid et de fibre de polyester.
Estructura recubierta de espuma de poliuretano flexible en frío y fibra de poliéster.
- ⑥ Polyurethane foam backrest support.
Support de dossier de mousse de polyuréthane.
Soporte de respaldo en espuma de poliuretano.

FRONT SOFA SECTION, FLOOR STANDING.
SECTION CANAPÉ FRONT, RAS DU SOL.
SECCIÓN SOFÁ FRONT, BASE A SUELO.

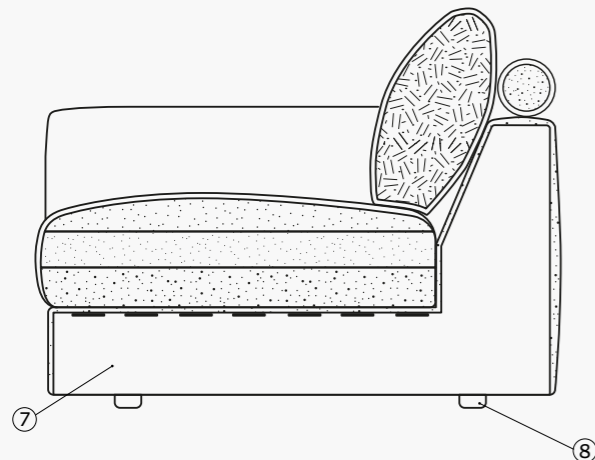

- ⑦ Wooden frame with elastic webbing suspension.
Châssis en bois avec suspension de sangles élastiques.
Bastidor de madera con suspensión de cinchas elásticas.
- ⑧ Metal feet with LDPE stops.
Pieds métalliques avec butées en PEBD.
Pies metálicos con topes de LDPE.

FRONT FEATURES

- Removable upholstery in the seat and back cushions.
- Wooden frame covered with flexible cold shaped polyurethane foam and polyester fibre.
- Seats in different polyurethane foam densities, with surface padding in fibre. Back cushions stuffed with polyester silicone fibre.
- Metal bases coated in polyester powder paint with a manganese topcoat and LDPE stops.
- Three back cushion heights available: Low (74 cm - 29.13"), Standard (81 cm - 31.89") or Premium (91 cm - 35.83").

FRONT TRAITS

- Tapiserie déhoussable sur les coussins de l'assise et coussins du dossier.
- Cadre en bois recouvert de mousse de polyuréthane souple à froid et de fibre de polyester.
- Assise réalisé dans différentes densités de mousse polyuréthane, matelassé en surface avec du fibre. Coussins du dossier garnis de fibre de polyester silicone.
- Pieds métalliques recouverts en peinture polyester en poudre finition manganèse avec butées en PEBD.
- Trois hauteurs de coussin pour les dossiers disponibles : Low (74 cm), Standard (81 cm) ou Premium (91 cm).

FRONT CARACTERÍSTICAS TÉCNICAS

- Tapicería desenfundable en cojines de asiento y cojines de respaldo.
- Bastidor de madera recubierto de espuma de poliuretano flexible en frío y fibra de poliéster.
- Asientos realizados en distintas densidades de espuma de poliuretano, acolchados en la superficie con fibra. Cojines de respaldo rellenos de fibra de poliéster siliconada.
- Patas metálicas recubiertas en pintura poliéster en polvo acabado manganeso con topes de LDPE.
- Tres alturas de cojín de respaldo disponibles: Low (74 cm), Standard (81 cm) o Premium (91 cm).

PADI FEATURES

- Available options for the top: American walnut, dark stained oak, natural oak, black oak or natural stone in three finishes to choose.
- Base with three metal legs coated with polyester powder manganese paint. LDPE stops.

PADI TRAITS

- Options disponibles pour le plateau : Placage de noyer américain, chêne teint, chêne naturel, chêne noir ou pierre naturelle en trois finitions au choix.
- Base avec trois pieds métalliques avec un revêtement de peinture polyester en poudre finition manganèse. Patins en PEBD.

PADI CARACTERÍSTICAS TÉCNICAS

- Opciones disponibles para el sobre: chapado en nogal americano, roble teñido oscuro, roble natural, roble negro o piedra natural en tres acabados a elegir.
- Estructura y patas metálicas recubiertas con pintura poliéster en polvo acabado manganeso. Topes en LDPE.

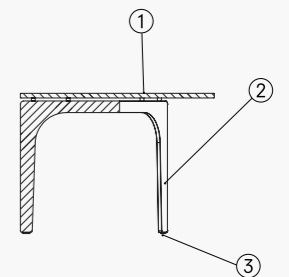

INNER CONSTRUCTION CONSTRUCTION INTERIEURE CONSTRUCCIÓN INTERIOR

PADI COFFEE TABLE SECTION.
SECTION TABLE BASSE PADI.
SECCIÓN MESA DE CAFÉ PADI.

- ① Top in wood or natural stone.
Plateaux en bois ou pierre naturel.
Sobre en madera o piedra natural.
- ② Metal base.
Base de metal.
Base metálica.
- ③ LDPE stops.
Butées en PEBD.
Topes de LDPE.

DIMENSIONS. FRONT.

SOFA. CANAPÉ. SOFÁ.

Elevated base. Base suspendue. Base suspendida.

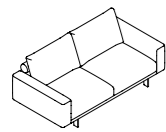

FROS194BS
194 x 96 H81
76.38"x 37.80" H31.89"

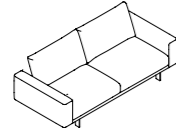

FROS214BS
214 x 96 H81
84.25"x 37.80" H31.89"

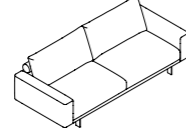

FROS234BS
234 x 96 H81
92.13"x 37.80" H31.89"

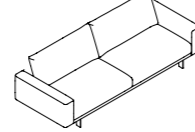

FROS254BS
254 x 96 H81
100"x 37.80" H31.89"

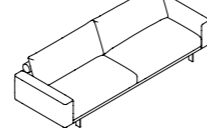

FROS274BS
274 x 96 H81
107.87"x 37.80" H31.89"

SOFA WITH 1 ARM. CANAPÉ. CANAPÉ AVEC 1 ACCOUDOIR. SOFÁ CON 1 BRAZO.

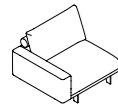

FROS1107BS
107 x 96 H81
42.13"x 37.80" H31.89"
IZQ.

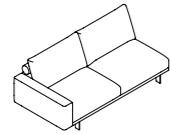

FROS1195BS
195 x 96 H81
76.77"x 37.80" H31.89"
IZQ.

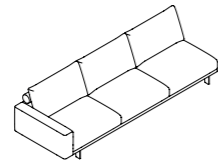

FROS1284BS
284 x 96 H81
111.81"x 37.80" H31.89"
IZQ.

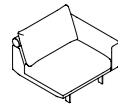

FROSD107BS
107 x 96 H81
42.13"x 37.80" H31.89"
DER.

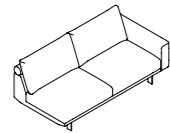

FROSD195BS
195 x 96 H81
76.77"x 37.80" H31.89"
DER.

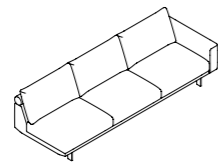

FROSD284BS
284 x 96 H81
111.81"x 37.80" H31.89"
DER.

SOFAS WITHOUT ARMS. CANAPÉS SANS ACCOUDOIRS. SOFÁS SIN BRAZOS.

CHAISE LONGUE.



FROS090BS
90 x 96 H81
35.43"x 37.80" H31.89"

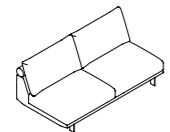

FROS0179BS
179 x 97 H81
70.47"x 38.19" H31.89"

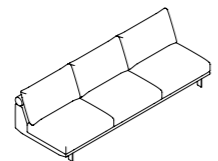

FROS0268BS
268 x 97 H81
105.51"x 38.19" H31.89"

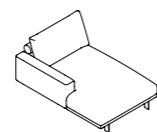

FROCLI107BS
107 x 170 H81
42.13"x 66.93" H31.89"

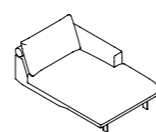

FROCLD107BS
107 x 170 H81
42.13"x 66.93" H31.89"

CORNER. ANGLE. RINCÓN.

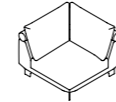

FROR94BS
94 x 94 H81
37.01"x 37.01" H31.89"

Single corner. Angle uni. Rincón simple.



FRORI183BS
183 x 96 H81
72.05"x 37.80" H31.89"
IZQ.

Single corner. Angle uni. Rincón simple.

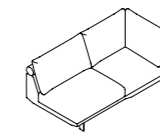

FRORD183BS
183 x 96 H81
72.05"x 37.80" H31.89"
DER.

Single corner. Angle uni. Rincón simple.

OPEN CORNER. ANGLE OUVERT. RINCÓN ABIERTO.

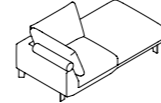

FRORI0187BS
187 x 96 H81
73.62"x 37.80" H31.89"
IZQ.

Left corner, right ottoman.
Angle gauche, pouf droit.
Rincón izquierdo, ottoman derecho.

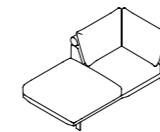

FRORD0187BS
187 x 96 H81
73.62"x 37.80" H31.89"
DER.

Right corner, left ottoman.
Angle droit, pouf gauche.
Rincón derecho, ottoman izquierdo.

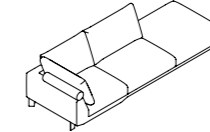

FRORI0277BS
277 x 96 H81
109.06"x 37.80" H31.89"
IZQ.

Left corner, right ottoman.
Angle gauche, pouf droit.
Rincón izquierdo, ottoman derecho.

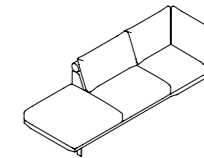

FRORD0277BS
277 x 96 H81
109.06"x 37.80" H31.89"
DER.

Right corner, left ottoman.
Angle droit, pouf gauche.
Rincón derecho, ottoman izquierdo.

SOFA CORNERS. CANAPÉS ANGLE. SOFÁS RINCÓN.

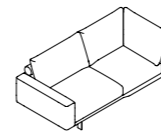

FROSIRD200BS
200 x 96 H81
78.74"x 37.80" H31.89"
IZQ.

Left arm, right corner.
Accoudoir gauche, angle droit.
Brazo izquierdo, rincón derecho.

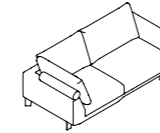

FROSDRI200BS
200 x 96 H81
78.74"x 37.80" H31.89"
DER.

Right arm, left corner.
Accoudoir droit, angle gauche.
Brazo derecho, rincón izquierdo.

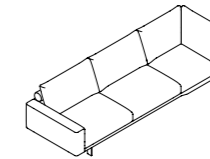

FROSIRD289BS
289 x 96 H81
113.78"x 37.80" H31.89"
IZQ.

Left arm, right corner.
Accoudoir gauche, angle droit.
Brazo izquierdo, rincón derecho.

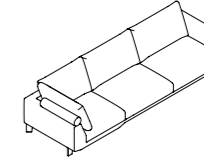

FROSDRI289BS
289 x 96 H81
113.78"x 37.80" H31.89"
DER.

Right arm, left corner.
Accoudoir droit, angle gauche.
Brazo derecho, rincón izquierdo.

OTTOMANS. POUFS. OTTOMANS.

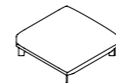

FROP96X96BS
96 x 96 H42
37.80"x 37.80" H16.54"

Corner ottoman. To be placed acting as a corner element.
Pouf angle. A placer comme élément d'angle.
Ottoman rincón. Para colocar actuando como elemento de esquina.

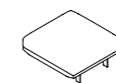

FROPT96X96BS
96 x 96 H42
37.80"x 37.80" H16.54"

Terminal ottoman. To be placed at the end of a composition.
Pouf terminal. A placer à la fin d'une composition.
Ottoman terminal. Para colocar al final de una composición.

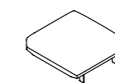

FROPI91X96BS
91 x 96 H42
35.83"x 37.80" H16.54"

Interleaved ottoman. To be placed between modules on a composition.
Pouf intercalé.
A placer entre les modules d'une composition.
Ottoman intercalado. Para ser colocado entre módulos de una composición.

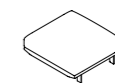

FROPE96X96BS
96 x 96 H42
37.80"x 37.80" H16.54"

Exempt ottoman. Works individually.
Pouf exonéré. Fonctionne individuellement.
Ottoman exento. Funciona individualmente.

SOFA. CANAPÉ. SOFÁ.

Floor standing. Ras du sol. Base a suelo.

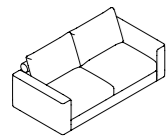

FROS194BT
194 x 96 H81
76.38"x 37.80" H31.89"

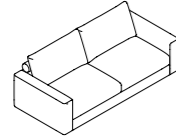

FROS214BT
214 x 96 H81
84.25"x 37.80" H31.89"

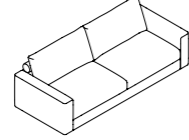

FROS234BT
234 x 96 H81
92.13"x 37.80" H31.89"

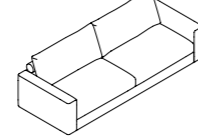

FROS254BT
254 x 96 H81
100"x 37.80" H31.89"

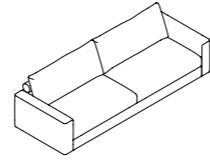

FROS274BT
274 x 96 H81
107.87"x 37.80" H31.89"

SOFA WITH 1 ARM. CANAPÉ. CANAPÉ AVEC 1 ACCOUDOIR. SOFÁ CON 1 BRAZO.

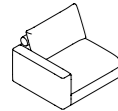

FROS1107BT
107 x 96 H81
42.13"x 37.80" H31.89"
IZQ.

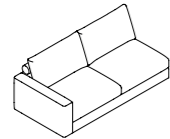

FROS1195BT
195 x 96 H81
76.77"x 37.80" H31.89"
IZQ.

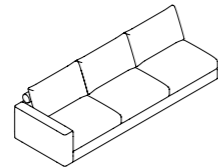

FROS1284BT
284 x 96 H81
111.81"x 37.80" H31.89"
IZQ.

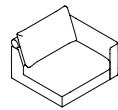

FROSD107BT
107 x 96 H81
42.13"x 37.80" H31.89"
DER.

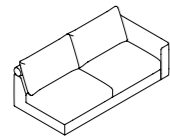

FROSD195BT
195 x 96 H81
76.77"x 37.80" H31.89"
DER.

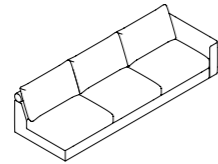

FROSD284BT
284 x 96 H81
111.81"x 37.80" H31.89"
DER.

SOFAS WITHOUT ARMS. CANAPÉS SANS ACCOUDOIRS. SOFÁS SIN BRAZOS.

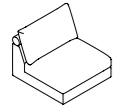

FROS090BT
90 x 96 H81
35.43"x 37.80" H31.89"

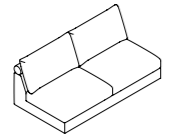

FROS0179BT
179 x 97 H81
70.47"x 38.19" H31.89"

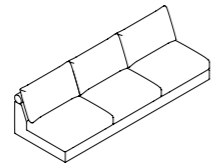

FROS0268BT
268 x 97 H81
105.51"x 38.19" H31.89"

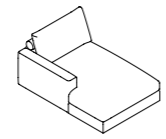

FROCLI107BT
107 x 170 H81
42.13"x 66.93" H31.89"

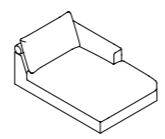

FROCLD107BT
107 x 170 H81
42.13"x 66.93" H31.89"

CHAISE LONGUE.

CORNER. ANGLE. RINCÓN.

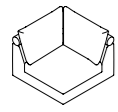

FROR94BT
94 x 94 H81
37.01"x 37.01" H31.89"

Single corner. Angle uni. Rincón simple.

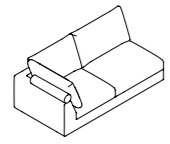

FRORI183BT
183 x 96 H81
72.05"x 37.80" H31.89"
IZQ.

Single corner. Angle uni. Rincón simple.

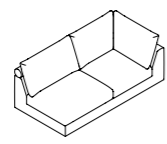

FRORD183BT
183 x 96 H81
72.05"x 37.80" H31.89"
DER.

Single corner. Angle uni. Rincón simple.

OPEN CORNER. ANGLE OUVERT. RINCÓN ABIERTO.

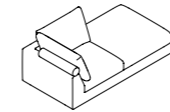

FRORI0187BT
187 x 96 H81
73.62"x 37.80" H31.89"
IZQ.
Left corner, right ottoman.
Angle gauche, pouf droit.
Rincón izquierdo, ottoman derecho.

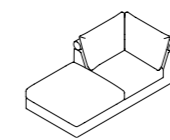

FRORD0187BT
187 x 96 H81
73.62"x 37.80" H31.89"
DER.
Right corner, left ottoman.
Angle droit, pouf gauche.
Rincón derecho, ottoman izquierdo.

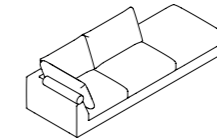

FRORI0277BT
277 x 96 H81
109.06"x 37.80" H31.89"
IZQ.
Left corner, right ottoman.
Angle gauche, pouf droit.
Rincón izquierdo, ottoman derecho.

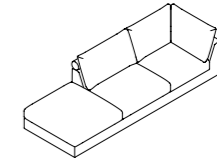

FRORD0277BT
277 x 96 H81
109.06"x 37.80" H31.89"
DER.
Right corner, left ottoman.
Angle droit, pouf gauche.
Rincón derecho, ottoman izquierdo.

SOFA CORNERS. CANAPÉS ANGLE. SOFÁS RINCÓN.

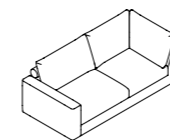

FROSIRD200BT
200 x 96 H81
78.74"x 37.80" H31.89"
IZQ.
Left arm, right corner.
Accoudoir gauche, angle droit.
Brazo izquierdo, rincón derecho.

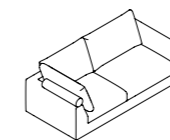

FROSDRI200BT
200 x 96 H81
78.74"x 37.80" H31.89"
DER.
Right arm, left corner.
Accoudoir droit, angle gauche.
Brazo derecho, rincón izquierdo.

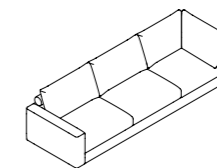

FROSIRD289BT
289 x 96 H81
113.78"x 37.80" H31.89"
IZQ.
Left arm, right corner.
Accoudoir gauche, angle droit.
Brazo izquierdo, rincón derecho.

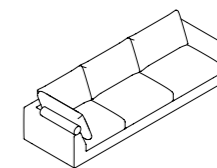

FROSDRI289BT
289 x 96 H81
113.78"x 37.80" H31.89"
DER.
Right arm, left corner.
Accoudoir droit, angle gauche.
Brazo derecho, rincón izquierdo.

OTTOMANS. POUFS. OTTOMANS.

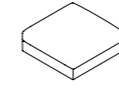

FROPC96X96BT
96 x 96 H42
37.80"x 37.80" H16.54"
Corner ottoman. To be placed acting as a corner element.
Pouf angle. A placer comme élément d'angle.
Ottoman rincón. Para colocar actuando como elemento de esquina.

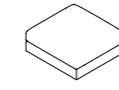

FROPT96X96BT
96 x 96 H42
37.80"x 37.80" H16.54"
Terminal ottoman. To be placed at the end of a composition.
Pouf terminal. A placer à la fin d'une composition.
Ottoman terminal. Para colocar al final de una composición.

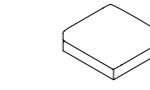

FROPI91X96BT
91 x 96 H42
35.83"x 37.80" H16.54"
Interleaved ottoman. To be placed between modules on a composition.
Pouf intercalé.
A placer entre les modules d'une composition.
Ottoman intercalado. Para ser colocado entre módulos de una composición.

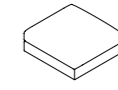

FROPE96X96BT
96 x 96 H42
37.80"x 37.80" H16.54"
Exempt ottoman. Works individually.
Pouf exonéré. Fonctionne individuellement.
Ottoman exento. Funciona individualmente.

PADI.

COFFEE TABLE. TABLE BASSE. MESA BAJA.



PADCRT37
37 x 37 H42
14.57"x 14.57" H16.54"
Round top.
Plateau rond.
Sobre redondo.



PADCRT50
50 x 50 H36
19.69"x 19.69" H18.31"
Round top.
Plateau rond.
Sobre redondo.



PADCRT102
102 x 102 H30
40.16"x 40.16" H11.81"
Round top.
Plateau rond.
Sobre redondo.

HOME COLLECTION.

SINGULAR.



Flow straight by Mario Ruiz



Flow curved by Mario Ruiz



Serene curved by Mario Ruiz



Serene curved by Mario Ruiz



Sledd by Mario Ruiz



Serene by Mario Ruiz



Serene by Mario Ruiz



Senso by Mario Ruiz



Deck by Mario Ruiz



Daily by Mario Ruiz



Grey by Mario Ruiz



Flow by Mario Ruiz



Flow chair by Mario Ruiz



Flow by Mario Ruiz



Flow by Mario Ruiz



Flow by Mario Ruiz



Ethos by Mario Ruiz



Ethos by Mario Ruiz



Serene by Mario Ruiz



Serene chair by Mario Ruiz



Serene chair by Mario Ruiz

SINGULAR.



Senso by Mario Ruiz



Deck by Mario Ruiz



Grey by Mario Ruiz



Senso by Mario Ruiz



Senso by Mario Ruiz



Senso by Mario Ruiz



Serene by Mario Ruiz



Serene by Mario Ruiz



Axis curved square side table by Mario Ruiz



Axis curved rectangular side table by Mario Ruiz



Axis curved rectangular coffee table by Mario Ruiz



Axis curved square coffee table by Mario Ruiz



Axis side table by Mario Ruiz



Axis rectangular coffee table by Mario Ruiz



Axis square coffee table by Mario Ruiz



Serene desk by Mario Ruiz



Serene furniture by Mario Ruiz

COZY.



Silence by Mario Ruiz



Time by Mario Ruiz



Time by Mario Ruiz



Silence by Mario Ruiz



Silence by Mario Ruiz



Silence by Mario Ruiz



Silence by Mario Ruiz

NEW CLASSIC.



Magnus by Mario Ruiz



Magnus by Mario Ruiz



Venice by Mario Ruiz



Venice by Mario Ruiz



Magnus by Mario Ruiz



Magnus by Mario Ruiz



Venice by Mario Ruiz



Venice by Mario Ruiz



Venice sofa bed by Mario Ruiz



Venice by Mario Ruiz



Venice by Mario Ruiz



Venice by Mario Ruiz

ESSENTIAL.



Front by Mario Ruiz



Front by Mario Ruiz



Pulse by Mario Ruiz



Park



June



Code



Bouvier by Dario Gagliardini



Hat by Dario Gagliardini



Ivy by Mario Ruiz



Ivy by Mario Ruiz



Ivy by Mario Ruiz



Pulse by Mario Ruiz



Pulse by Mario Ruiz



Ivy sofa bed by Mario Ruiz



Suma H 40 cm by Mario Ruiz.



Suma H 40 cm by Mario Ruiz.



Mika tray by Mario Ruiz



Depart H 39 cm by Mario Ruiz.



Depart H 46 cm by Mario Ruiz



Depart SQ H 39 cm by Mario Ruiz



Pulse furniture by Mario Ruiz



Padi coffee table H 30 cm
by Mario Ruiz



Padi coffee table H 36 cm
by Mario Ruiz



Padi coffee table H 42 cm
by Mario Ruiz



Tab round and square coffee tables
H 46,5 cm by Mario Ruiz



Tab rectangular coffee tables
H 46,5 cm by Mario Ruiz



Tab occasional tables H 55,6 cm
by Mario Ruiz



Tab task tables H 55,6 cm
by Mario Ruiz



Tab task table H 50,8 cm
by Mario Ruiz



Tab work tables H 66,1 cm
by Mario Ruiz



Sacha SE side table
by Mario Ruiz



Sacha SE rectangular coffee tables
by Mario Ruiz



Sacha SE square coffee table
by Mario Ruiz



Sacha SQ side table
by Mario Ruiz



Sacha SQ rectangular coffee table
by Mario Ruiz



Sacha SQ square coffee table
by Mario Ruiz



Mika bedside table
by Mario Ruiz

OUTDOOR COLLECTION.

SINGULAR.



Sledd Outdoor by Mario Ruiz



Sledd Outdoor by Mario Ruiz



Serene Outdoor by Mario Ruiz



Serene Outdoor by Mario Ruiz



Bene side table H 30 cm
by Mario Ruiz



Bene side table H 42 cm
by Mario Ruiz



Bene rectangular coffee table
by Mario Ruiz



Bene square coffee table
by Mario Ruiz



Axis Outdoor side table H 30 cm
by Mario Ruiz



Axis Outdoor side table H 42 cm
by Mario Ruiz



Axis Outdoor rectangular coffee table
by Mario Ruiz



Axis Outdoor square coffee table
by Mario Ruiz

COZY.



Silence Outdoor by Mario Ruiz



Silence Outdoor by Mario Ruiz

CONTRACT COLLECTION.

SYSTEMS. SYSTÈMES. SISTEMAS MODULARES.



Flow straight system by Mario Ruiz



Flow curved system by Mario Ruiz



Serene curved system by Mario Ruiz



Serene curved system by Mario Ruiz



Daily Contract system by Mario Ruiz



Deck Contract system by Mario Ruiz



Depart system by Mario Ruiz



Summ system by Mario Ruiz



Depart power modules by Mario Ruiz

SOFAS. CANAPÉS. SOFÁS.

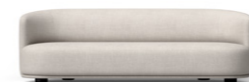

Flow straight by Mario Ruiz



Flow curved by Mario Ruiz



Serene curved by Mario Ruiz



Serene curved by Mario Ruiz



Daily Contract by Mario Ruiz



Deck Contract by Mario Ruiz



Summ by Mario Ruiz



Depart by Mario Ruiz



Depart Screen by Mario Ruiz



Grey Contract by Mario Ruiz



Serene Screen by Mario Ruiz



Venice Contract by Mario Ruiz

ARMCHAIRS. FAUTEUILS. BUTACAS.



Flow by Mario Ruiz



Flow chair by Mario Ruiz



Bouvier by Dario Gagliardini



Deck by Mario Ruiz



Deck Contract by Mario Ruiz



Depart by Mario Ruiz



Grey by Mario Ruiz



Grey Contract by Mario Ruiz



Hat by Dario Gagliardini



Magnus by Mario Ruiz



Senso by Mario Ruiz



Serene by Mario Ruiz



Serene Screen by Mario Ruiz



Serene chair by Mario Ruiz



Time by Mario Ruiz



Venice by Mario Ruiz



Venice Contract by Mario Ruiz



Venice Contract by Mario Ruiz

OTTOMANS & BENCHES. POUFS ET BANQUETTES. OTTOMANS Y BANCOS.



Flow by Mario Ruiz



Flow by Mario Ruiz



Flow by Mario Ruiz



Suma H 40 cm by Mario Ruiz



Suma H 40 cm by Mario Ruiz



Mika tray by Mario Ruiz



Depart H 39 cm by Mario Ruiz



Depart H 46 cm by Mario Ruiz



Depart SQ H 39 cm by Mario Ruiz

FURNITURE. MEUBLES. MUEBLES.



Serene desk by Mario Ruiz



Serene furniture by Mario Ruiz



Pulse furniture by Mario Ruiz



Padi coffee table H 30 cm
by Mario Ruiz



Padi coffee table H 36 cm
by Mario Ruiz



Padi coffee table H 42 cm
by Mario Ruiz



Tab round and square coffee tables
H 46,5 cm by Mario Ruiz



Tab rectangular coffee tables
H 46,5 cm by Mario Ruiz



Tab occasional tables H 55,6 cm
by Mario Ruiz



Tab task tables H 55,6 cm
by Mario Ruiz



Tab task table H 50,8 cm
by Mario Ruiz



Tab work tables H 66,1 cm
by Mario Ruiz



Sacha SE side table
by Mario Ruiz



Sacha SE rectangular coffee tables
by Mario Ruiz



Sacha SE square coffee table
by Mario Ruiz



Sacha SQ side table
by Mario Ruiz



Sacha SQ rectangular coffee table
by Mario Ruiz



Sacha SQ square coffee table
by Mario Ruiz



Axis side table
by Mario Ruiz



Axis rectangular coffee table
by Mario Ruiz



Axis square coffee table
by Mario Ruiz



Axis curved rectangular side table
by Mario Ruiz



Axis curved rectangular coffee table
by Mario Ruiz



Axis curved square coffee table
by Mario Ruiz



Axis curved square side table
by Mario Ruiz



Mika bedside table
by Mario Ruiz

Creative Direction
Mario Ruiz

Concept, Art Direction & Graphic Design
Studio Ainhoa Nagore

Photography
Ángel Segura

Set Design
Olivia Ricard/Slowkind

Special thanks to
Alzeta Gallery
DomésticoShop
Cotlin

Printing
Ce.Ge

Joquer Tapicerías S.A. reserves the right to change, without previous notice, materials, covers, finishes and drawings of the products presented in this catalogue. The textures and colours of materials and finishes are indicative as they are depending on the tolerances of the printing process.

Joquer Tapicerías, S.A. se réserve le droit de modifier sans préavis, les matériaux, tissus, finitions et dessins des produits représentés dans ce catalogue. Les textures et les couleurs des matériaux et des finitions sont présentés à titre indicatif et les teintes peuvent varier en fonction des techniques d'impression utilisées.

Joquer Tapicerías S.A. se reserva el derecho de modificar, sin previo aviso, materiales, tejidos, acabados y dibujos de los productos representados en este catálogo. Las texturas y colores de los materiales y acabados son indicativos dependiendo de las variaciones del proceso de impresión.

