

capdell

Catalogue / Catálogo

Capdell

Calle Flora Tristán, 24, 46970 Alaquàs,
Valencia

+34 961 502 950
info@capdell.com



capdell

Unique pieces / *Piezas únicas*

Everyone is different. We all have different experiences, we've faced different challenges, achieved different successes. If you study the world around you, focus through the haze of the rush and the broad strokes, you can find these differences in tiny details.

What is surprising is that these tiny details and differences are what make people stand out from the crowd, they are expressions of our personalities and our humanity.

Craftsmanship is an art that has existed since the beginning of humanity, but in a world where industrialisation has produced uniformity the craftsman is ever more important, he adds innovation, quality, attention to detail, individuality. It's knowledge that passes from person to person, generation to generation, enriched over time.

At Capdell, this knowledge has been evolving for more than 50 years and has allowed us to innovate, experiment, play and dream. We are always seeking to enhance the sensations that connect us with the product, the smell of wood, the warmth of the upholstery, the elegance of the design.

Working with extinguished and talented designers, among many others, we are able to give life to their visions in our Valencia factory allowing for strong and open communication at all stages of the process.

Our furniture carries the spirit of everyone at Capdell, from the hands that made them to the minds that designed them, each piece brings a little of each of us with it, make it into "unique pieces".

Cada persona con la que nos cruzamos en nuestro día es única y diferente. Las circunstancias y nuestra forma de afrontar las situaciones y retos nos marcan y definen, dejando ver la realidad que hay en cada uno.

Son estos pequeños detalles y diferencias los que hacen que las personas destaquen entre la multitud, son expresiones de nuestras personalidades y nuestra humanidad.

La artesanía es un arte que existe desde los inicios de la humanidad. En un mundo donde la industrialización ha producido uniformidad, el artesano es cada vez más importante, añade innovación, calidad, atención al detalle, individualidad. Es un conocimiento que se transmite de persona a persona, de generación en generación, enriquecido con el tiempo.

En Capdell, este conocimiento ha ido evolucionando durante más de 50 años y nos ha permitido innovar, experimentar, jugar y soñar. Siempre buscamos potenciar las sensaciones que nos conectan con el producto, el olor a madera, la calidez de la tapicería, la elegancia del diseño.

Trabajando con diseñadores con un reconocido prestigio internacional, somos capaces de dar vida a sus visiones e ideas en nuestra fábrica situada en Valencia.

Nuestros muebles llevan el espíritu de todo el equipo Capdell, desde las manos que los hicieron hasta las mentes que los diseñaron, cada pieza trae consigo un poco de cada uno de nosotros, convirtiéndose en "piezas únicas".

Designers / Diseñadores



Carlos Tiscar



Claesson | Koivisto | Rune



EstudiHac



Fiorenzo Dorigo



Francesc Rifé



Fran Silvestre



Gabriel Teixidó



Isidro Ferrer



Kazuko Okamoto



Luca Nichetto



Lucy Kurrein



Marcel Sigel



Mario Ruíz



Patrick Norguet



Sebastian Herkner

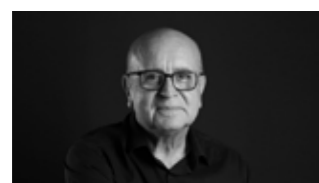

Vicent Martínez



Yonoh

Our values / Nuestros valores

craftwork / artesanía

Where industrialisation has produced uniformity the craftsman adds innovation, quality, attention to detail, individuality.

Our knowledge has been evolving for more than 50 years and has allowed us to innovate, experiment, play and dream.

We are always seeking to enhance the sensations that connect us with the product.

Mientras la industrialización ha creado productos uniformes el artesano agrega innovación, calidad y atención al detalle, individualidad.

Nuestro conocimiento ha ido evolucionando durante más de 50 años, esto nos ha permitido innovar, experimentar, jugar y soñar.

Buscamos siempre potenciar las sensaciones que nos conecten con el producto.

sustainability / sostenibilidad

In the manufacture of our products we only use renewable, recycled and 100% recyclable materials. Once the life of our product is over, its components can be easily separated for recycling.

We optimize our production to improve our environmental efficiency.

Reliability, durability and easy repair. Our furniture is made to last, for which we give a guarantee of 10 years for products for indoor use and 2 years for products for outdoor use.

En la fabricación de nuestros productos sólo empleamos materiales renovables, reciclados y 100% reciclables. Una vez finalizada la vida de nuestro producto sus componentes pueden separarse fácilmente para su reciclado.

Optimizamos nuestra producción para mejorar nuestra eficiencia ambiental.

Fiabilidad, duración y fácil reparación. Nuestros muebles están hechos para durar por ellos damos una garantía de 10 años para productos de uso interior y 2 años para productos de uso exterior.

innovation / innovación

We analyze the latest trends to provide customers with current products and finishes.

We optimize the structures of our products so that they are as resistant as possible with the least amount of material.

We are in the continuous search for improvement to provide the best to our customers and partners.

Analizamos las últimas tendencias para aportar a los clientes productos y acabados actuales.

Optimizamos las estructuras de nuestros productos para que sean los más resistentes posible con la menor cantidad de material.

Estamos en la continua búsqueda de la mejora para aportar lo mejor a nuestros clientes y partners.

design / diseño

We bet on design. For this reason, each of our pieces has a unique and differentiating design.

We work with nationally and internationally renowned designers.

We apply the latest trends to provide the market with the most groundbreaking and current designs.

Apostamos por el diseño. Por ello cada una de nuestras piezas tiene un diseño único y diferenciador.

Trabajamos con diseñadores de renombre nacional e internacional.

Aplicamos las últimas tendencias para proporcionar al mercado los diseños más rompedores y actuales.

Seat and
stools /
Asientos y
taburetes



12 A-COLLECTION
by Fran Silvestre



20 ARO
by Carlos Tiscar



30 ATRIA
by Gabriel Teixidó



38 AVA
by Carlos Tiscar



88 ECO
by Carlos Tiscar



96 FLICK
by Vicente Soto



100 HELIUM
by David Redondo



106 ICONICA
by Gabriel Teixidó



154 MATCH
by Patrick Norguet



162 MOON
by Gabriel Teixidó



172 NARA
by Mario Ruiz



182 NIX
by Patrick Norguet



226 ATOLL
by Fiorenzo Dorigo



232 BOLERO
by Claesson Koivisto Rune



240 BRIDGE
by Vicente Soto



248 DROPLETS
by Claesson Koivisto Rune



290 ABLE
by Fiorenzo Dorigo



296 ATRIA
by Gabriel Teixidó



300 BASIC TABLES
by Capdell



306 GUS
by Francesc Rifé



352 TRISTAR
by Claesson Koivisto Rune



358 W
by Gabriel Teixidó



364 ARO
by Carlos Tiscar



370 DROPLETS
by Claesson Koivisto Rune



46 CAPITA
by Fiorenzo Dorigo



52 CÉCILE
by Mario Ruiz



62 COL
by Francesc Rifé



70 CONCORD
by Claesson Koivisto Rune



82 DUAL
by Carlos Tiscar



114 ICS
by Fiorenzo Dorigo



120 LEIZU
by Estudiabac



128 LOOP
by Patrick Norguet



136 MARIETTA
by Yonoh



146 MARTA
by Gabriel Teixidó



192 PANEL
by Lucy Kurrein



200 POLO
by Yonoh



206 STIR
by Kazuko Okamoto



212 ULIS
by Sebastian Hekner



220 WEDGE
by Marcel Sigel



256 ÍNSULA
by Patrick Norguet



264 NODAL
by Luca Nichetto



274 PLUM
by Claesson Koivisto Rune



282 VISION
by Fiorenzo Dorigo

8 Sofas /
Sofás

Tables /
Mesas



314 GAZELLE
by Claesson Koivisto Rune



320 LIBRIS
by Vicent Martínez



332 NOOK
by Mario Ruiz



340 MESANA
by Salvador Villalba



346 MESANA DESK
by Patrick Norguet



376 ÍNSULA
by Patrick Norguet

SEAT AND
STOOLS /
*ASIENTOS Y
TABURETES*



12

A collection

Design by Fran Silvestre

EN Collection of chairs, armchairs, stools and armchairs with straight lines of great visual lightness. Formed by the union of two elements, metal and wood, which together provide warmth and ergonomics. Designed by the architect Fran Silvestre, conceived as a sculptural piece for common spaces, hotels, restaurants, homes.

The steel tube structure is available in different colors, as well as the oak shell or, upholstered version for greater comfort.

Due to the characteristics of the metal and wood that compose it, they can be recycled, contributing to the circular economy.

ES Colección de sillas, sillones, taburetes y butacas de líneas rectas de gran ligereza visual. Formada por la unión de dos elementos, metal y madera, juntos aportan calidez y ergonomía. Diseñada por el arquitecto Fran Silvestre, concebida como pieza escultórica para espacios comunes, hoteles, restaurantes y hogares.

La estructura de acero esta disponible en diferentes colores así como la carcasa en roble o versión tapizada para mayor comodidad.

Debido a las características del metal y la madera que la componen pueden ser reciclados contribuyendo a la economía circular.

13

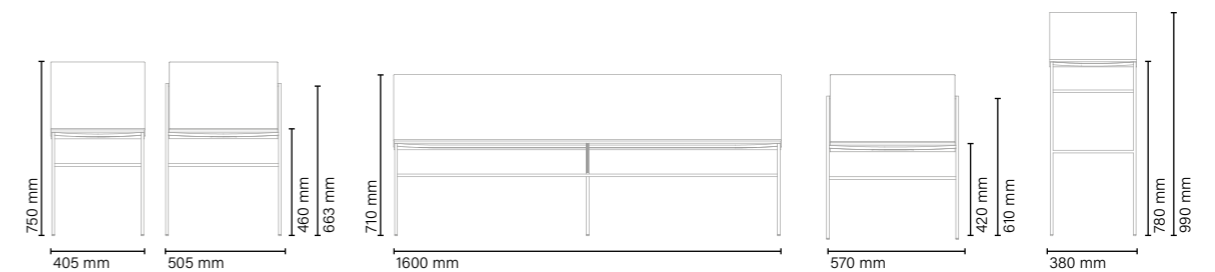





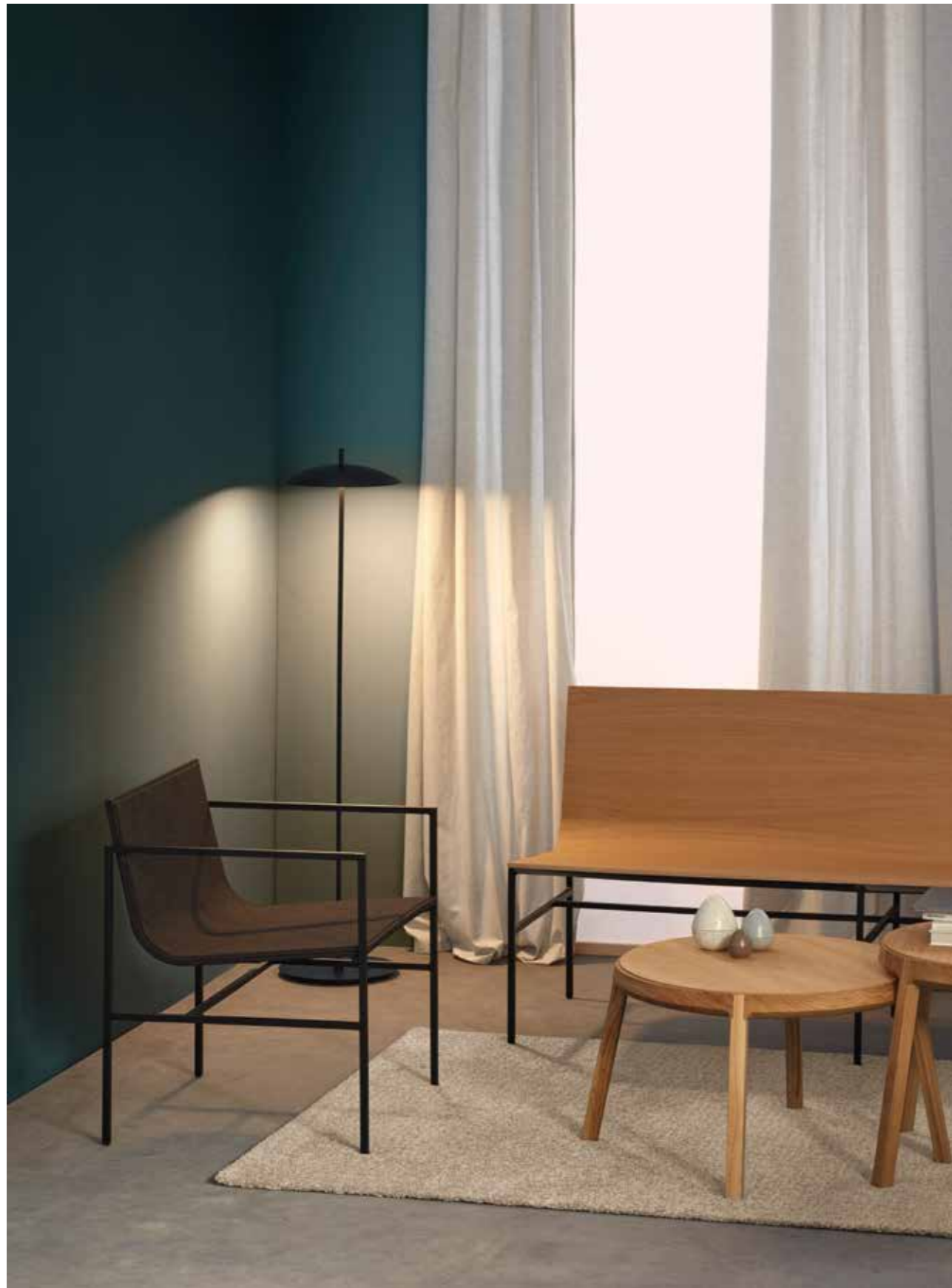

A collection

Chair / Sillas



460P
Upholstered chair with oak shell and solid steel structure / Silla semitapizada con carcasa de roble y estructura de acero



460R
Oak wood chair with solid steel structure / Silla con carcasa de roble y estructura de acero

Armchair / Sillón



462P
Upholstered armchair with oak shell and solid steel structure / Sillón semitapizado con carcasa de roble y estructura de acero



462R
Oak wood armchair with solid steel structure / Sillón con carcasa de roble y estructura de acero

Lounge & bench / Butaca & banco



464P
Upholstered lounge chair with oak shell and solid steel structure / Butaca semitapizada con carcasa de roble y estructura de acero



464R
Oak wood lounge chair with solid steel structure / Butaca con carcasa de roble y estructura de acero



465P
Upholstered bench with oak shell and solid steel structure / Banco semitapizado con carcasa de roble y estructura de acero



465R
Oak wood bench with solid steel structure / Banco con carcasa de roble y estructura de acero

Stool / Taburete



469P
Upholstered stool with oak shell and solid steel structure / Taburete semitapizado con carcasa de roble y estructura de acero



469R
Oak wood stool with solid steel structure / Taburete con carcasa de roble y estructura de acero



ARO collection

Design by Carlos Tiscar

EN Aro is a collection with a timeless, comfortable and enveloping design, which reinterprets the round seat typology, referring to traditional cabinetmaking.

With the common denominator of the circle through which various elements such as chairs, armchairs, stools and side tables are achieved.

The warmth of the wood and its upholstered versions make it a perfect option for a wide variety of spaces in hotels, restaurants, work environments, home.

Made with PEFC sustainable wood, it can be recycled promoting the circular economy.

ARO LOW TABLES PAGE 364

ES Aro es una colección con un diseño atemporal, cómoda y envolvente, que reinterpreta la tipología de asiento redondo, evocando a la ebanistería tradicional.

Con el círculo como denominador común de la colección se consiguen diversos elementos como sillas, butacas, taburetes y mesitas auxiliares.

La calidez de la madera y sus versiones tapizadas, la convierten en una opción perfecta para gran variedad de espacios en hoteles, restaurantes, entornos de trabajo, hogar.

Fabricada con maderas sostenibles PEFC, esta puede ser reciclada fomentando la economía circular.

MESITAS ARO PÁGINA 364

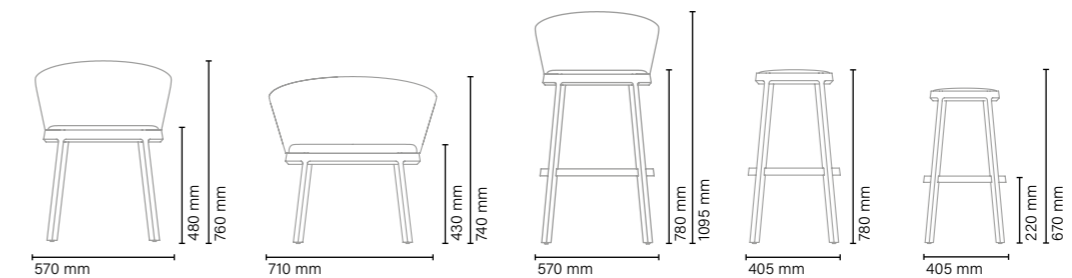

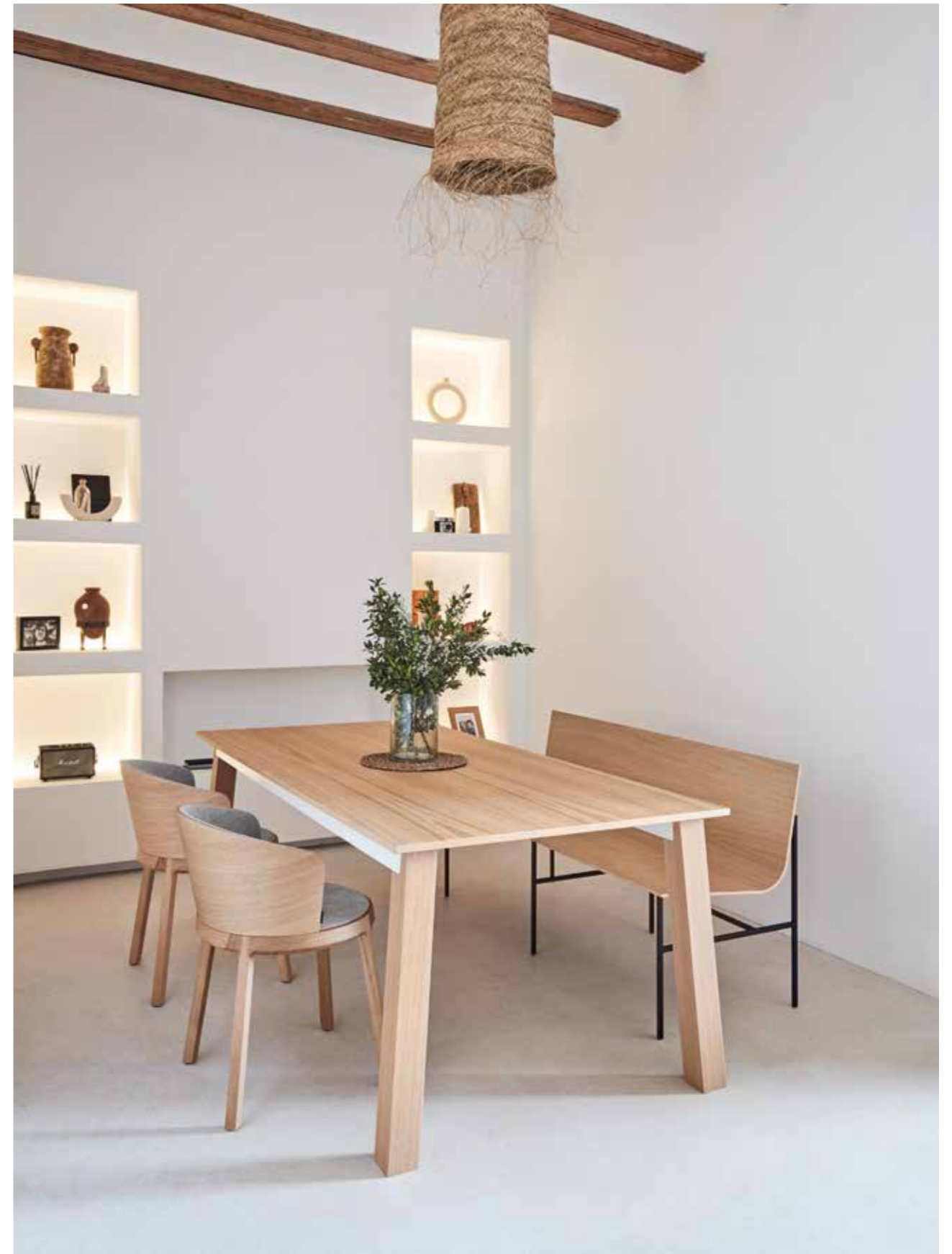







ARO collection

Chair / Sillas**691T**

Upholstered armchair with beech or oak wood base / Silla tapizada con base de madera de roble o haya

**691M**

Semi upholstered armchair with beech or oak wood base and backrest / Silla semitapizada con base y respaldo de madera de roble o haya

Lounge / Butaca**695T**

Upholstered lounge chair with beech or oak wood base / Butaca tapizada con base de madera de roble o haya

**695M**

Semi upholstered lounge chair with beech or oak wood base and backrest / Butaca semitapizada con base y respaldo de madera de roble o haya

Stool / Taburete**699**

Upholstered stool with solid beech or oak wood base / Taburete tapizado con base de madera maciza de haya o roble

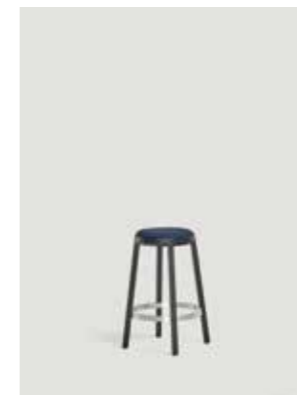
**699H65**

Upholstered stool with solid beech or oak wood base / Taburete tapizado con base de madera maciza de haya o roble

**691TH78**

Upholstered stool with solid beech or oak wood base / Taburete tapizado con base de madera maciza de haya o roble

**691MH78**

Semi upholstered stool with solid beech or oak wood base and backrest / Taburete semi tapizado con base y respaldo de madera maciza de haya o roble



30

ATRIA collection

Design by Gabriel Teixidó

EN Atria is a collection of seats that includes a chair, an armchair and a lounge chair. Its soft and light shapes emanate the warmth of the materials, solid oak for the structure and leather for the seat and back.

The detail of the seam at the ends of the seat and backrest stands out, and the braiding that tightens the leather in the lower part. Its name refers to the atrium of Roman houses, around which the social life of the house revolved. It also means the brightest star.



ES Atria es una colección de asientos, compuesta por silla, sillón y butaca. Sus formas suaves y ligeras emanan la calidez de los materiales, el roble macizo para la estructura y cuero en asiento y respaldo.

Destaca el detalle de la costura en los extremos del asiento y el respaldo, y el trenzado que tensa el cuero en la parte baja. Su nombre hace referencia al atrio de las viviendas romanas, en torno al cual giraba la vida social de la casa. También significa la estrella que más brilla.

31

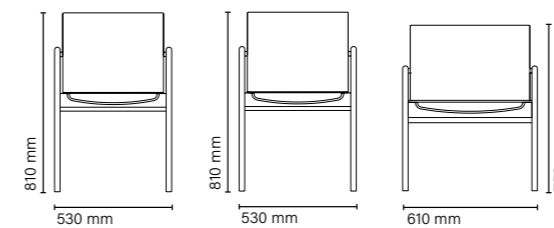







ATRIA collection

Chair / Sillas



2322

Oak wood stained chair with traditional upholstered of premium leather / *Silla Atria, estructura de madera de roble con tapizado tradicional de cuero premium*

Armchair / Sillón



2323

Oak wood stained armchair with traditional upholstered of premium leather / *Sillón Atria, estructura de madera de roble teñida en S80 con tapizado tradicional de cuero premium*

Lounge Chair / Butaca



2325

Oak wood stained lounge chair with traditional upholstered of premium leather / *Butaca con estructura de madera de roble con tapizado tradicional de cuero premium*



38

AVA collection

Design by Carlos Tiscar

EN Ava is a collection of chairs and armchairs with a versatile and timeless design. Solid beech wood frame. The beveled legs create a visual effect of lightness by playing with the volumetry depending on the angle from which it is viewed. The backrest and seat are upholstered and adapt to the shapes of the body to provide great comfort.

Ideal for projects that require a durable and resistant chair such as hotels, restaurants, home.

Made with PEFC sustainable wood and easily recycled.

ES Ava es una colección de silla y sillón con un diseño versátil y atemporal. De estructura de madera de haya maciza. El biselado de las patas crea un efecto visual de ligereza jugando con la volumetría en función del ángulo del que se observe. El respaldo y asiento están tapizados y se adaptan a las formas del cuerpo para proporcionar un gran confort.

Ideal para proyectos que requieran una silla duradera y resistente como hoteles, restaurantes, hogar.

Fabricada con maderas sostenibles PEFC y de fácil reciclado.

39

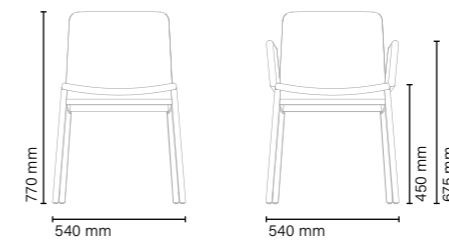



40



41





AVA collection

Chair / Silla



646

Upholstered chair with beech wood
base / *Silla tapizada con base de madera
de haya*

Armchair / Sillón



646N

Upholstered armchair with beech wood
base / *Sillón tapizado con base de
madera de haya*



46

CAPITA collection

Design by Fiorenzo Dorigo

EN Elegant and versatile, Capita is a wide beech chair, which reclaims its space almost as if it were an armchair, and at the same time, has a light and warm appearance, thanks to the joinery work and its fine seat, which seems to float above the structure.

Composed of chair and armchair with footrest. With a PEFC sustainable solid wood structure, smooth contours with ergonomic seat and backrest that provide high comfort and durability.

Due to its design, it works well alone or combined, either at home and in hotels, restaurants or common areas.

ES Elegante y polivalente, Capita es una silla de haya de porte ancho, que reclama su espacio casi como si se tratara de un sillón, y al mismo tiempo, tiene un aspecto ligero y cálido, gracias al cuidadoso trabajo de la madera y a su fino asiento, que parece flotar sobre la estructura.

Compuesta por silla y butaca con reposapiés. Estructura de madera maciza sostenible PEFC, de suaves contornos con asiento y respaldo ergonómicos que proporcionan un alto confort y durabilidad.

Por su diseño, funciona bien sola o en conjunto, tanto en hogar como en hoteles, restaurantes o zonas comunes.

47

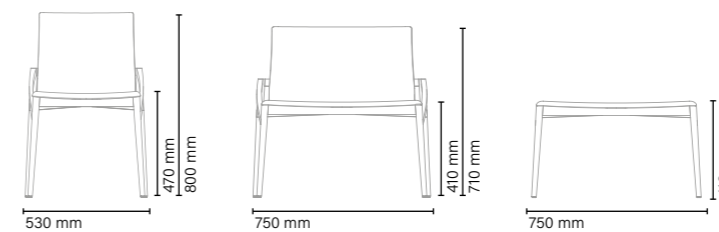





CAPITA collection

Chair / Sillas



510T

Upholstered chair with beech wood base / Silla tapizada con base de madera de haya

Lounge Chair / Butaca



511T

Upholstered lounge chair with beech wood base / Butaca tapizada con base de madera de haya

Restfoot / Reposapiés



512T

Upholstered restfoot with beech wood base / Reposapiés tapizado con base de madera de haya



52

CÉCILE collection

Design by Mario Ruiz

EN Cécile is a timeless design collection in organic and welcoming shapes, a wonderfully comfortable piece that praises craftsmanship, and with great adaptability to different scenarios and uses.

Its simplicity results in versatility to adapt to spaces of a very different nature, both in contract, in multipurpose spaces, in flexible and reconfigurable hybrid areas, and at home.

Despite its lightness, it is a collection with a robust identity, with a characteristic language of curves and counter-curves in a 36 mm diameter cylindrical structure with no visible joining elements. Consistent with the lines outlining the structure of the piece, the seat and backrest have a gentle curvature that envelops the body with balanced proportions.

The chair can be entirely made in wood, or with the seat and backrest upholstered combining various densities of polyurethane foam. In its metallic version, with painted Steel tube, its appearance conveys the same warmth as the wooden version while maintaining its enveloping shapes and delivering an image of great comfort.

In addition to these two versions, there is also an outdoor Cécile with an aluminium structure, armchair, stool and chair without arms. All versions of chairs are stackable.

ES Colección de diseño atemporal, de formas orgánicas y acogedoras. Cécile es una pieza muy comfortable que ensalza el trabajo artesanal y que tiene una gran capacidad de adaptación a diferentes escenarios y usos.

Su sencillez se traduce en versatilidad para adaptarse a espacios de muy diferente naturaleza, tanto en contract, en espacios polivalentes, híbridos flexibles y reconfigurables, así como en hogar.

Pese a su ligereza, se trata de una colección de identidad robusta, con un lenguaje característico de curvas y contracurvas en una estructura cilíndrica de 36 mm de diámetro sin elementos de unión vistos. En coherencia con las líneas que dibujan la estructura de la pieza, el asiento y el respaldo tienen también una suave curvatura que envuelve el cuerpo con unas proporciones equilibradas.

La silla puede ser totalmente en madera o con el asiento y respaldo tapizado combinando varias densidades de espuma de poliuretano. En su versión metálica, con tubo de acero pintado, su apariencia proyecta la misma calidez que la versión de madera y mantiene las formas envolventes transmitiendo una imagen de mucho confort.

Además de estas dos versiones, Cécile tiene también versión de silla para exterior, descalzadora, taburete y silla. En todas sus versiones se trata de una silla apilable.

53

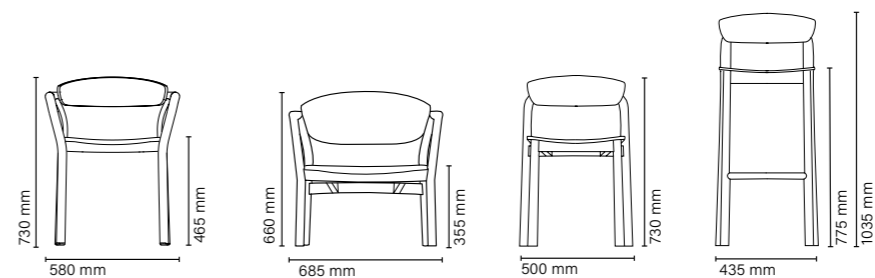



54



55



56

57



CÉCILE collection*Chair / Sillas*

2343M
Chair with solid ash wood frame. Front and back in plywood / *Silla con madera maciza de fresno. Asiento y respaldo de madera*



2343T
Chair with solid ash wood frame. Upholstered front and back / *Silla con madera maciza de fresno. Asiento y respaldo tapizado*

Armchair / Sillón

2341M
Armchair with ash solid wood structure and seat and back of ash plywood / *Sillón con estructura de madera maciza de fresno y asiento y respaldo en madera contrachapada*



2341T
Armchair with ash solid wood structure and seat and back upholstered / *Sillón con estructura de madera maciza de fresno y asiento y respaldo tapizado*



2342M
Armchair with metal structure and seat and back of ash plywood / *Silla con estructura de metal y asiento y respaldo en madera contrachapada*



2342T
Armchair with metal structure and seat and back upholstered / *Sillón con estructura de metal y asiento y respaldo tapizados*

Outdoor / Exterior

2341MIR
Armchair with Iroko solid wood structure, seat and back / *Sillón con estructura, asiento y respaldo de madera maciza de Iroko*



2141AL
Armchair with aluminium structure, seat and backrest / *Sillón con estructura, asiento y respaldo aluminio*

Lounge Chair / Butaca

2345M
Lounge chair with solid ash wood frame. Front and back in plywood / *Butaca con madera maciza de fresno. Asiento y respaldo de madera*



2345T
Lounge chair with solid ash wood frame. Upholstered front and back / *Butaca con madera maciza de fresno. Asiento y respaldo tapizado*

Stool / Taburete

2349M
Stool with solid ash wood frame. Front and back in plywood / *Taburete con madera maciza de fresno. Asiento y respaldo de madera*



2349T
Stool with solid ash wood frame. Upholstered front and back / *Taburete con madera maciza de fresno. Asiento y respaldo tapizado*



2349SM
Stool with solid ash wood frame. Front in plywood / *Taburete con madera maciza de fresno. Asiento de madera*



COL collection

Design by Francesc Rifé

EN A reinterpretation of the typical school chair of the 80s and 90s, Col is a collection of chairs made of curved steel tube, coated with epoxy paint, with curved oak laminate seat and back.

Its friendly and balanced shape make it a perfect option for work spaces, hospitality and home.

With a comfortable and completely timeless design, it is available in wood and upholstered versions.

ES Una reinterpretación de la típica silla de colegio de los años 80 y 90, Col es una colección de sillas de tubo de acero curvado, recubierto de pintura epoxi, con asiento y respaldo laminado de roble curvado.

Su forma amable y equilibrada la convierten en una opción perfecta para espacios de trabajo, hostelería y hogar.

Con un diseño cómodo y completamente atemporal, está disponible en versión madera y tapizada.

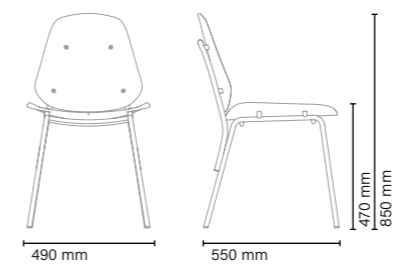



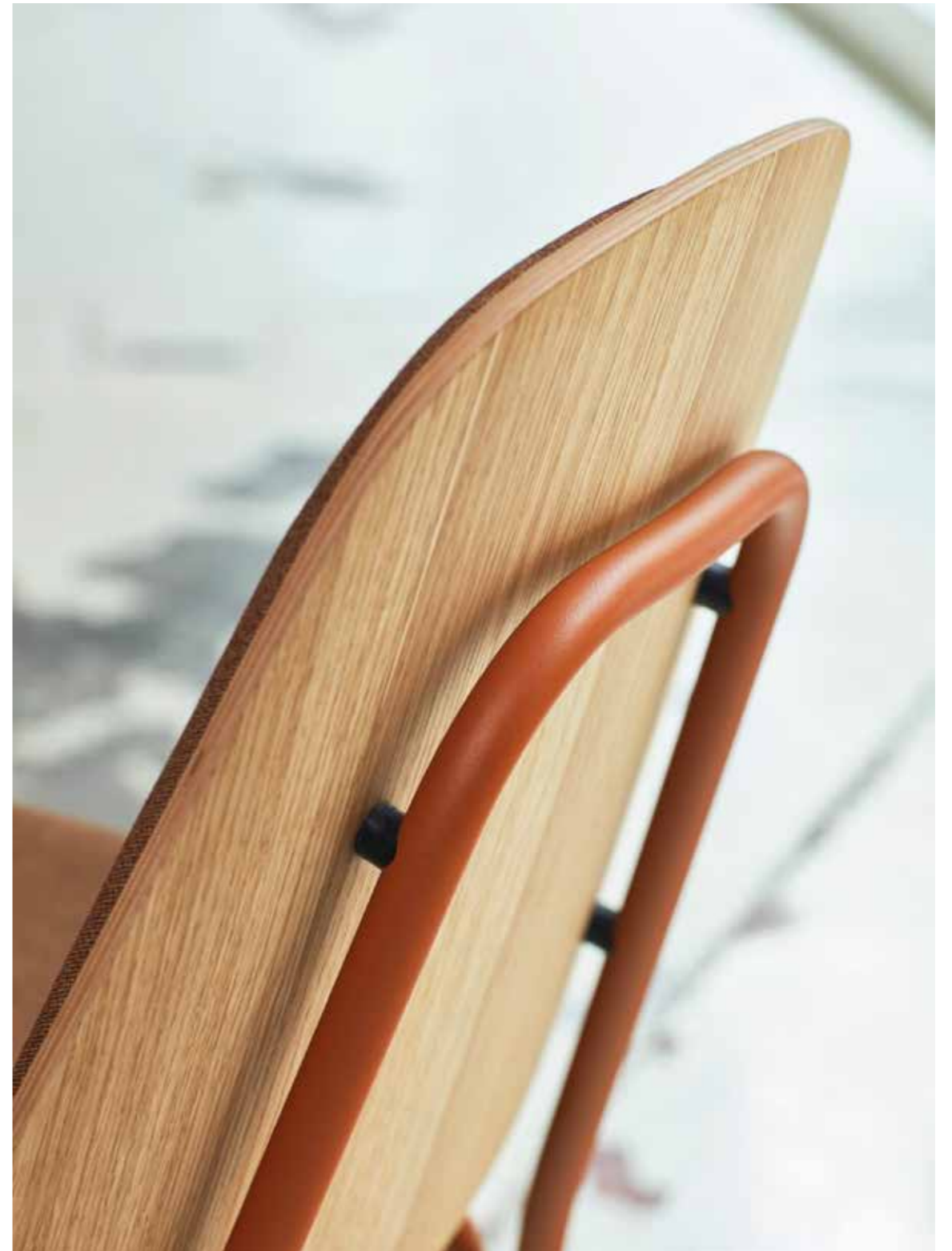



COL collection

Chair / Sillas



370M

Chair with oak veneer shell and steel structure / Silla con carcasa chapada en madera de roble y estructura de acero



370P

Upholstered chair with oak veneer shell and steel structure / Silla semitapizada con carcasa chapada en madera de roble y estructura de acero



CONCORD collection

Design by Claesson Koivisto Rune

EN Inspired by the wonderful layers of the earth's atmosphere, those that can sometimes be seen at sunset or from an airplane.

The main feature of the Concord collection is its horizontal division into layers. The legs, support frame, seat, lower backrest/armrest, and upper backrest represent separate visual levels.

The Concord collection comprises a large number of variants based on the basic structure made up of one, two or three horizontal pieces of curved plywood that are combined in different sizes and finishes: upholstered, exposed wood or mixed combinations.

The base is available in different configurations, including beech or oak wood bases or aluminum bases. Perfect for residential use, restaurants, work spaces or common areas.

ES Inspirada en las maravillosas capas de la atmósfera terrestre, esas que a veces se pueden percibir al atardecer o desde un avión.

La característica principal de la colección Concord es su división horizontal en capas. Las piernas, el marco de soporte, el asiento, el reposabrazos o respaldo inferior y el respaldo superior representan niveles visuales separados.

La colección Concord comprende un gran número de variantes a partir de la estructura básica compuesta por una, dos o tres piezas horizontales de madera contrachapada curvada que se combinan en distintos tamaños y acabados: tapizados, madera vista o combinaciones mixtas.

La base está disponible en diferentes configuraciones, incluyendo bases de madera de haya o roble o bases de aluminio. Perfecta para uso residencial, restaurantes, espacios de trabajo o zonas comunes.

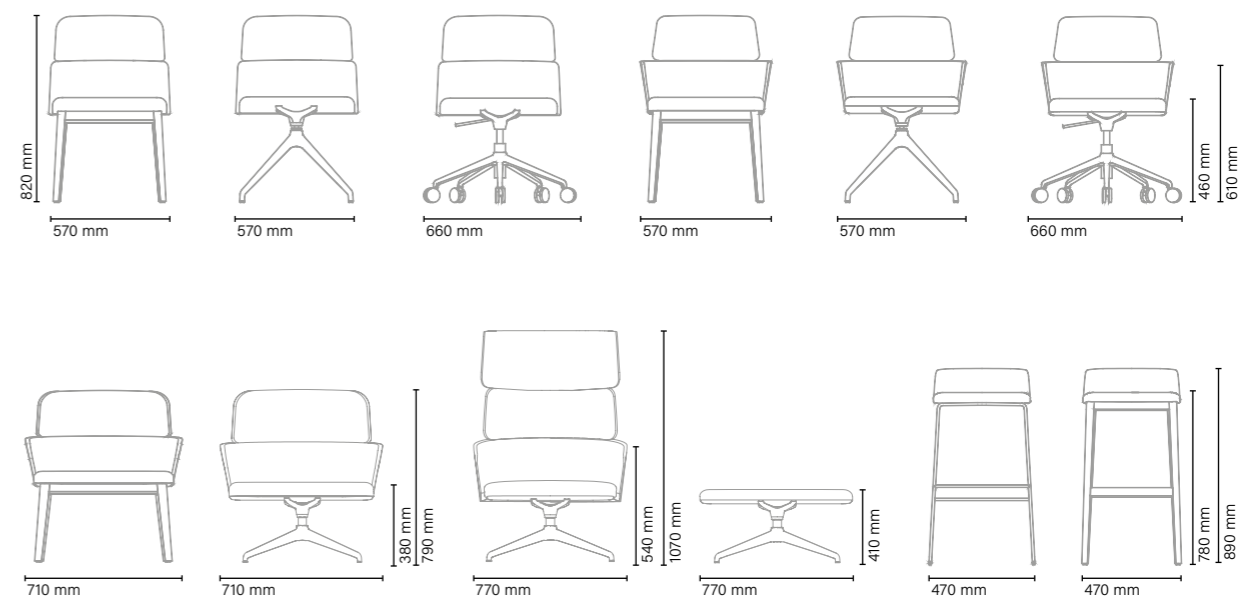

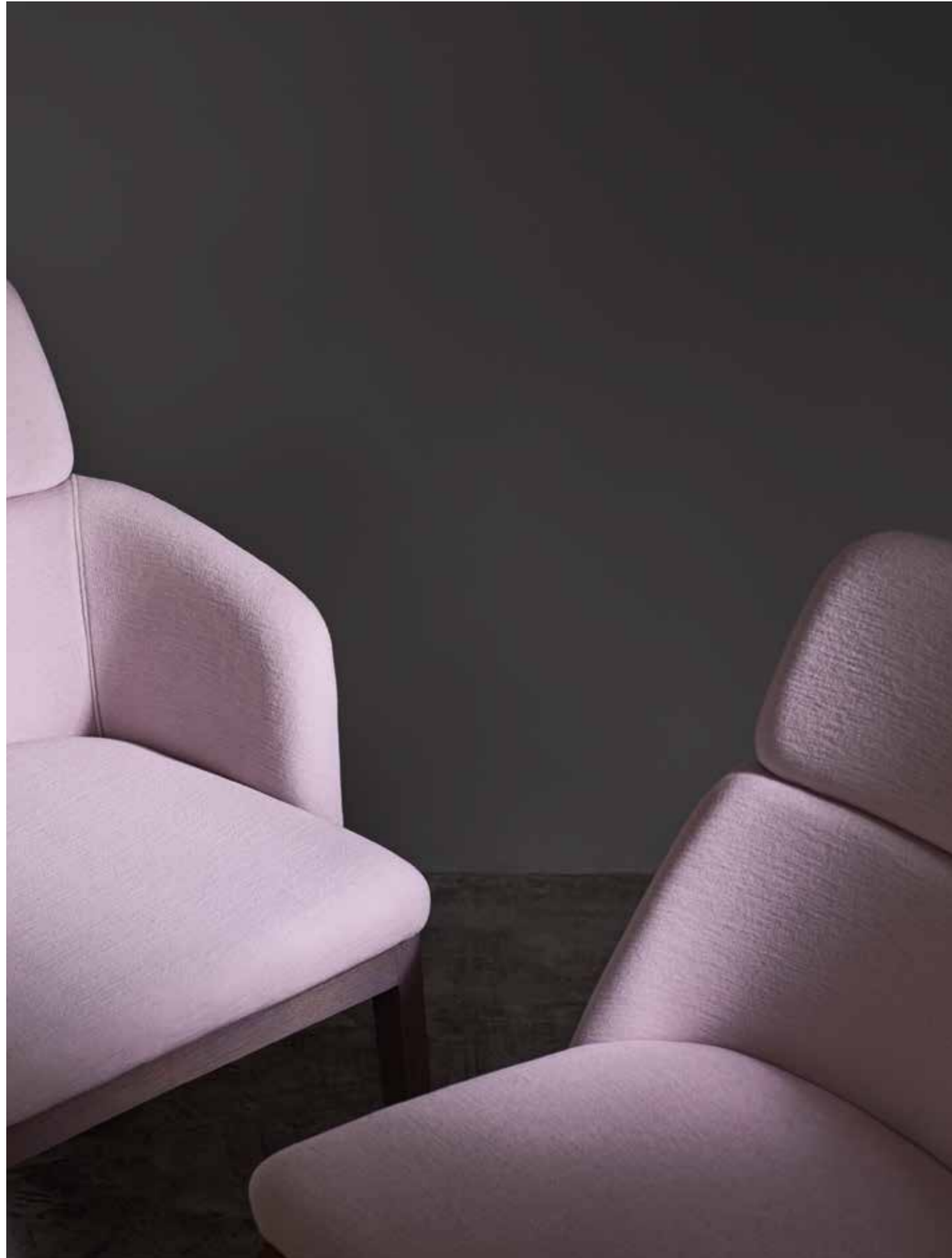



74

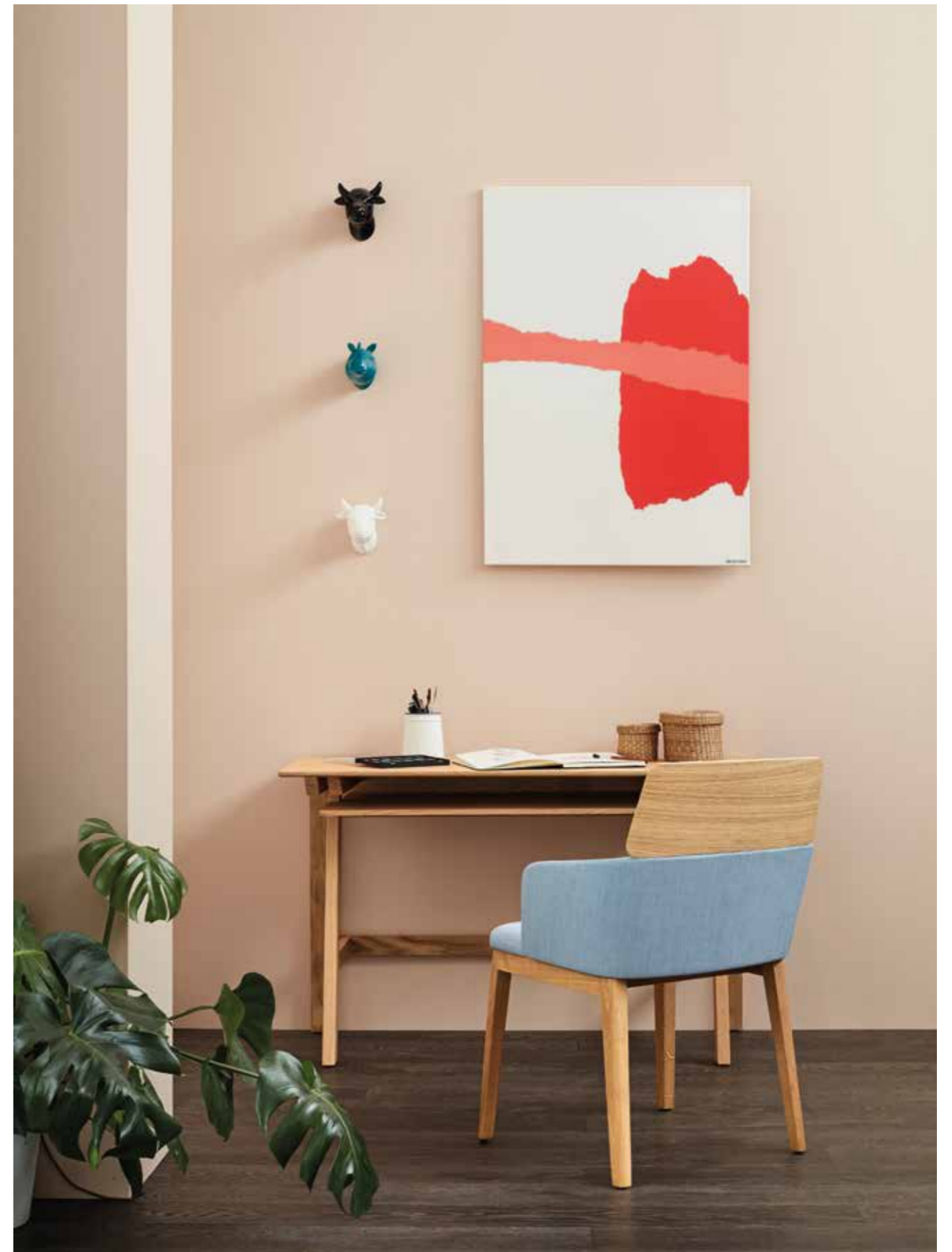

75





CONCORD collection

Chair / *Sillas*

522UM
Upholstered chair with beech or oak wood base / *Silla tapizada con base de madera de haya o roble*



522WM
Semi upholstered chair with beech wood or oak base and backrest / *Silla semitapizada con base y respaldo de madera de haya o roble*



522UD
Upholstered chair with aluminium base / *Silla tapizada con base de aluminio*



522WD
Upholstered chair with beech wood or oak backrest and aluminium base / *Silla tapizada con respaldo de haya o roble y base de aluminio*



522UDR
Upholstered chair with aluminium base fitted with castor wheels / *Silla tapizada con base de aluminio equipada con ruedas*



522WDR
Semi upholstered chair with aluminium base fitted with castor wheels / *Silla semitapizada con base de aluminio equipada con ruedas*



523UM
Upholstered armchair with beech or oak wood base / *Sillón tapizado con base de madera de haya o roble*



523WM
Semi upholstered armchair with beech wood or oak base and backrest / *Sillón semitapizado con base y respaldo de madera de haya o roble*



523UD
Upholstered armchair with aluminium base / *Sillón tapizado con base de aluminio*



523WD
Upholstered armchair with beech wood or oak backrest and aluminium base / *Sillón tapizado con respaldo de haya o roble y base de aluminio*



523UDR
Upholstered armchair with aluminium base fitted with castor wheels / *Sillón tapizado con base de aluminio equipada con ruedas*



523WDR
Semi upholstered armchair with aluminium base fitted with castor wheels / *Sillón semitapizado con base de aluminio equipada con ruedas*

Lounge Chair / *Butaca*

525DB
Upholstered lounge chair with aluminium base / *Butaca tapizada con base de aluminio*



525UM
Upholstered lounge chair with beech or oak wood base / *Butaca tapizada con base de madera de haya o roble*



527DB
Upholstered lounge chair relax with aluminium base / *Sillón relax tapizado con base de aluminio*



528DB
Upholstered restfoot relax with aluminium base / *Reposapiés tapizado con base de aluminio*

Stool / *Taburete*

529M
Upholstered stool with beech or oak wood base / *Taburete tapizado con base de madera de haya o roble*



529M65
Upholstered stool with beech or oak wood base / *Taburete tapizado con base de madera de haya o roble*



529V
Upholstered stool with solid steel structure / *Taburete tapizado con estructura de varilla patin de acero*



529M65
Upholstered stool with solid steel structure / *Taburete tapizado con estructura de varilla patin de acero*



521MB65
Upholstered stool with beech or oak wood base / *Taburete tapizado con base de madera de haya o roble*



82

DUAL collection

Design by Gabriel Teixidó

EN The DUAL collection combines simple, elegant lines with exceptional comfort. Its timeless design stands out for the careful balance between upholstery and solid beech wood, sustainably certified by PEFC, underscoring our commitment to the environment.

Designed to naturally adapt to contract spaces such as restaurants, hotels, or residences, DUAL shines through the detail where the upholstery meets the wood at the chair's front. This contrast of materials creates a subtle duality that adds character and sophistication to the collection. Signed by renowned designer Gabriel Teixidó, this collection reflects his mastery in creating functional, timeless designs, ideal for projects seeking a blend of style and versatility.

ES La colección DUAL combina líneas simples y elegantes con un confort excepcional. Su diseño atemporal destaca por un cuidado equilibrio entre el tapizado y la madera de haya maciza, con certificación sostenible PEFC, que garantiza nuestro compromiso con el medio ambiente.

Pensada para integrarse con naturalidad en espacios contract como restaurantes, hoteles o residencias, DUAL sobresale por el detalle donde el tapizado se encuentra con la madera en la parte frontal. Este contraste de materiales crea una sutil dualidad que aporta carácter y sofisticación a la colección. Firmada por el reconocido diseñador Gabriel Teixidó, esta colección refleja su maestría en el diseño funcional y atemporal, ideal para proyectos que buscan una mezcla de estilo y versatilidad.

83

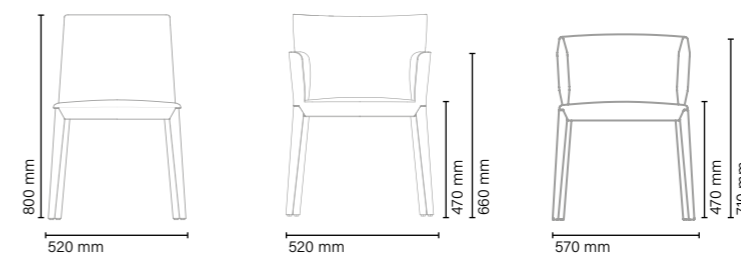





DUAL collection

Chair / Sillas



480B

Upholstered chair with beech wood base / *Silla tapizada con base de madera de haya*

Armchair / Sillón



482

Upholstered armchair with beech wood base / *Sillón tapizado con base de madera de haya*



483

Upholstered armchair with beech wood base / *Sillón tapizado con base de madera de haya*



88

ECO collection

Design by Carlos Tiscar

EN The complex skeleton-like structure is the main feature of this model. It marks the personality of the chair and defines it as an almost sculptural object that, despite its bareness, is warm and welcoming due to its shape and the natural materials used in its construction.

The structure, without edges, transmits so much strength and stability that it seems to rise from the ground instead of resting on it. Stackable chairs.

ES La compleja estructura a modo de esqueleto constituye el rasgo principal de este modelo. Marca la personalidad de la silla y la define como un objeto casi escultórico, que a pesar de la desnudez, resulta cálido y acogedor por la forma y los materiales naturales empleados en su construcción.

La estructura, carente de aristas, transmite tanta fuerza y estabilidad que parece surgir del suelo en lugar de apoyarse sobre él. Sillas apilables



89

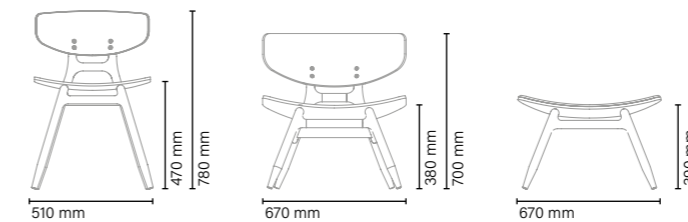



90

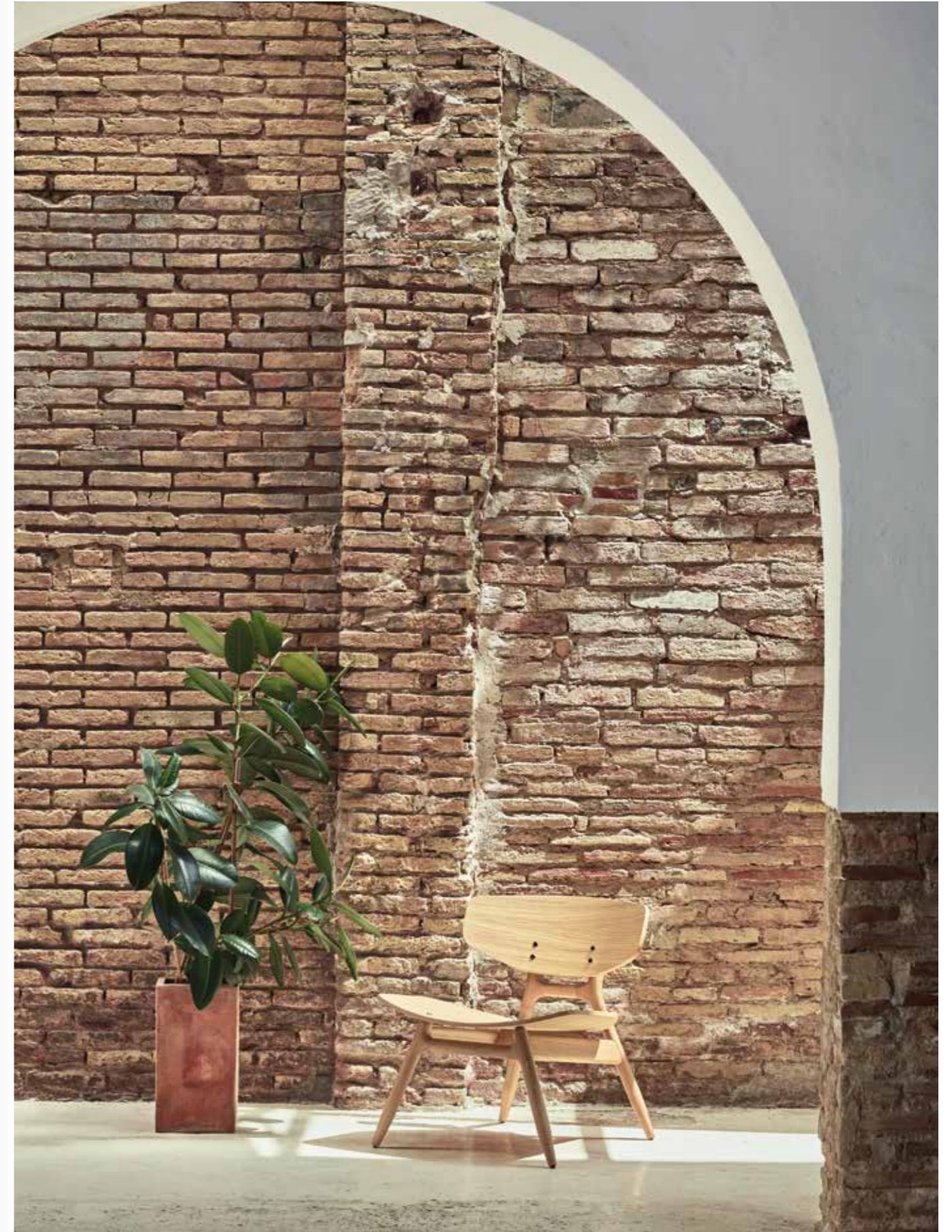

91



92



93



ECO collection

Chair / Sillas



500M

Chair with beech or oak wood base, restback and seat / Silla con estructura, respaldo y asiento de madera de haya o roble



500P

Semi upholstered chair with beech or oak wood base, restback and seat / Silla semitapizada con estructura, respaldo y asiento de madera de haya o roble



500T

Upholstered chair with beech or oak wood base / Silla tapizada con estructura, de madera de haya o roble

Lounge Chair / Butaca



501M

Lounge chair with beech or oak wood base, restback and seat / Butaca con estructura, respaldo y asiento de madera de haya o roble



501P

Semi upholstered lounge chair with beech or oak wood base, restback and seat / Butaca semitapizada con estructura, respaldo y asiento de madera de haya o roble



501T

Upholstered lounge chair with beech or oak wood base / Butaca tapizada con estructura, de madera de haya o roble

Restfoot / Reposapiés



501REP

Semi upholstered restfoot with beech or oak wood base, restback and seat / Reposapiés semitapizada con estructura, respaldo y asiento de madera de haya o roble



96

FLICK collection

Design by Vicente Soto

EN From the search for perfection for the balance between aesthetics and functionality, the Flick collection is born.

A chair with an internal metal frame and flexible injected backrest and square metal legs available in different colours. With a strong and simple timeless aesthetic, it has proven to be an excellent choice, both for sophisticated and elegant home spaces, and for furnishing installations that require intensive use.

ES De la búsqueda de la perfección por el equilibrio entre estética y funcionalidad nace la colección Flick.

Una silla con una estructura interna metálica y respaldo inyectado flexible y patas cuadradas metálicas disponibles en diferentes colores. Con una estética intemporal robusta y sencilla, ha demostrado con la ser una excelente elección, tanto para espacios sofisticados y elegantes de hogar, como para el equipamiento de instalaciones que requieren de un uso intensivo.

97

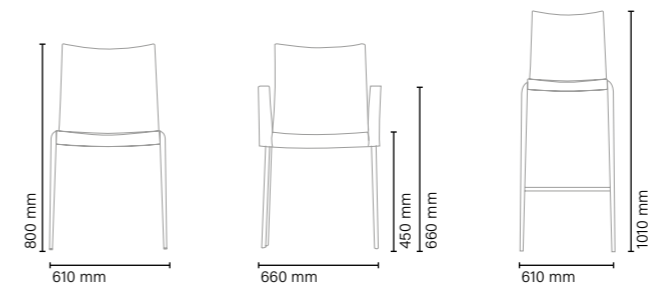



FLICK collection

Chair / Sillas



824C

Stackable chair with a metal base and injected foam shell / *Silla apilable con estructura metálica y carcasa de espuma inyectada*

Armchair / Sillón



824NC

Armchair with a metal base and injected foam shell / *Sillón con estructura metálica y carcasa de espuma inyectada*

Stool / Taburete



829C

Stackable stool with a metal base and injected foam shell / *Taburete apilable con estructura metálica y carcasa de espuma inyectada*



HELIUM collection

Design by David Redondo

EN The Helium collection stands out for its unique and original design, making it a piece that invites exploration and tactile enjoyment. Every detail has been meticulously crafted to offer the user an unparalleled experience.

The first encounter with the chair delivers an immediate sense of comfort, thanks to its generous volumes and enveloping shapes, inspired by the aesthetic of Jeff Koons' works. Despite its bold presence, the chair's light and delicate design creates an illusion of buoyancy, as if filled with helium, bringing a touch of lightness to any space.

ES La colección Helium destaca por su diseño único y original, convirtiéndola en una pieza que invita a ser explorada y disfrutada al tacto. Cada detalle ha sido meticulosamente diseñado para ofrecer una experiencia incomparable al usuario.

El primer encuentro con la silla transmite una sensación inmediata de comodidad, gracias a sus volúmenes generosos y formas envolventes, que evocan la estética de las obras de Jeff Koons. A pesar de su imponente presencia, su diseño ligero y delicado crea una ilusión de flotabilidad, como si estuviera llena de helio, añadiendo un toque de ligereza a cualquier espacio.

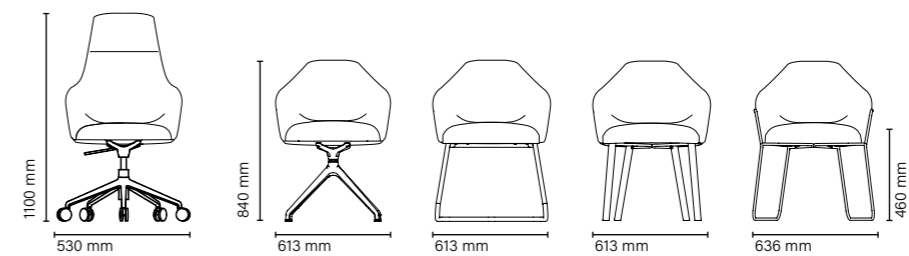



102



103



HELIUM collection

Armchair / Sillón



2330PTN

Upholstered armchair with metal base /
Sillón tapizado con base patin



2330DR

Upholstered armchair with five swivel
aluminium base fitted with castor wheels
/ Sillón tapizado con base de aluminio de
cinco radios con ruedas



2330D

Upholstered armchair with four swivel
aluminium base / Sillón tapizado con base
giratoria de aluminio de cuatro radios



2330CAN

Upholstered armchair with metal cantilever
base / Sillón tapizado con base de metal
cantiléver



2330TNS

Upholstered armchair with solid steel
base / Sillón tapizado con base de varilla
de acero de tensor



2330W

Upholstered armchair with solid ash
base / Sillón tapizado con base de
madera de fresno macizo



2331DR

Upholstered armchair, high shell, with
five swivel aluminium base fitted with
castor wheels / Sillón tapizado, carcasa
alta, con base de aluminio de cinco radios
con ruedas



2331D

Upholstered armchair, high shell, with
four swivel aluminium base / Sillón
tapizado, carcasa alta, con base de
aluminio de cuatro radios



106

ICONICA collection

Design by Gabriel Teixidó

EN The Iconica lounge chair is the result of the combination of aesthetics and functionality.

With a clear respect for tradition and local craftsmanship, it is upholstered with a braided system that uses top quality suede leather.

Its unique structure in solid beech wood is under PEFC certification, which guarantees that it comes from responsibly managed forests in accordance with the strictest environmental, social and economic requirements.

A piece that makes its presence impact the environment.

ES La butaca Iconica es el resultado de la combinación de estética y funcionalidad.

Con un claro respeto por la tradición y la artesanía local, está tapizada con un sistema trenzado que utiliza piel serraje de primera calidad.

Su estructura única en madera maciza de haya está bajo la certificación PEFC, que garantiza que procede de bosques gestionados de forma responsable de acuerdo con los más estrictos requisitos medioambientales, sociales y económicos.

Una pieza cuya presencia impacta en el entorno.

107

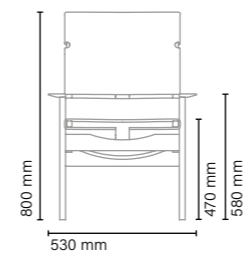



108



109





ICONICA collection

Lounge Chair / Butaca



245V

Lounge chair with beech wood frame.
Handcrafted upholstery with premium
leather / *Butaca con estructura de madera
de haya. Tapizado artesanal de vaqueta*



245S

Lounge chair with beech wood frame.
Handcrafted upholstery with suede leather
/ *Butaca con estructura de madera de haya.
Tapizado artesanal de cuero afelpado.*



245L

Lounge chair with beech wood frame.
Upholstered using sailcloth, foam and
fabric or leather / *Butaca con estructura de
madera de haya. Tapizada usando loneta,
espuma y tela o piel.*

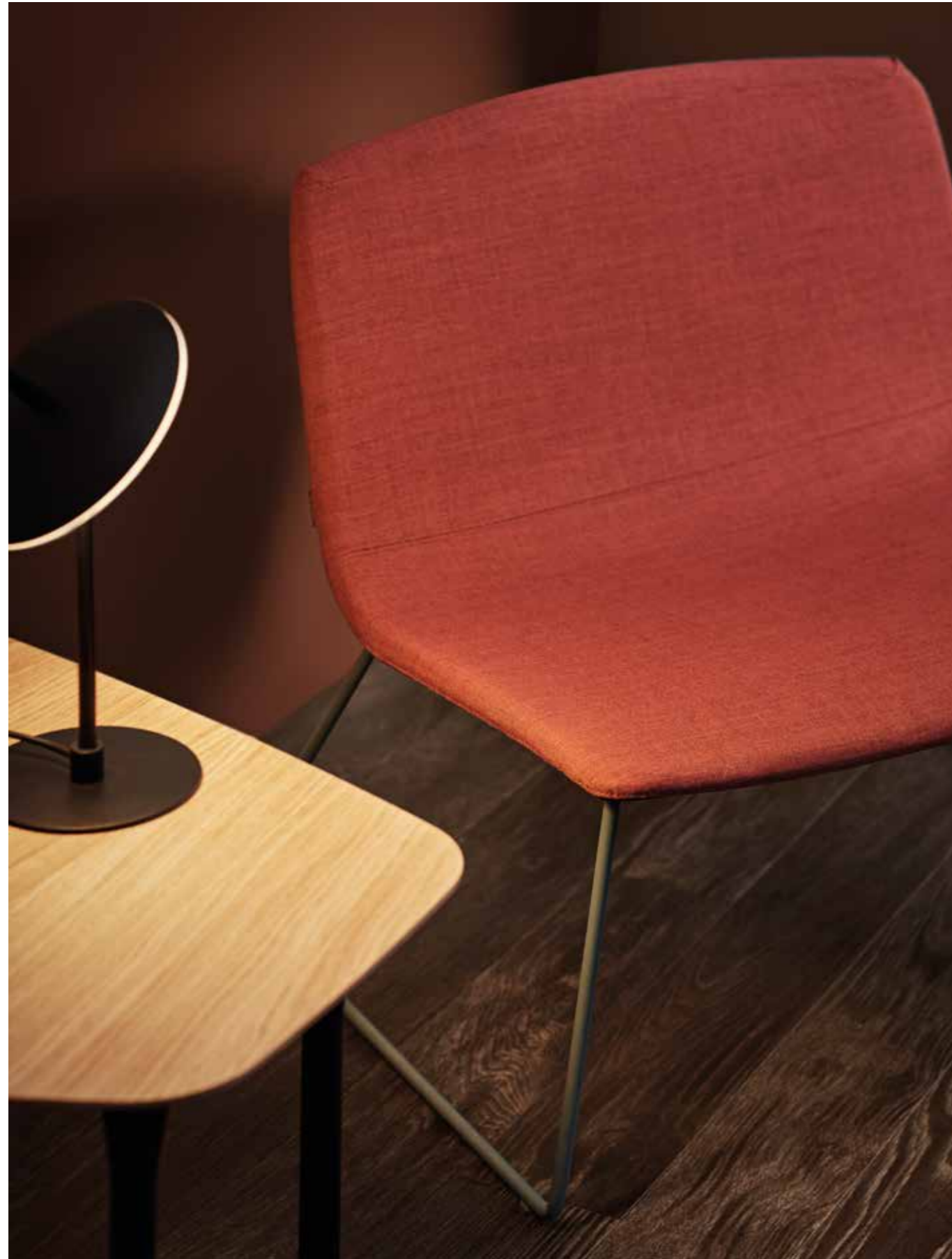

ICS collection

Design by Fiorenzo Dorigo

EN Versatile collection that starts with a shell made of a metal structure covered with high-resistance, injected polyurethane, offering flexibility and a lightweight visual appeal. Its upholstery and the use of various support materials, such as wood and metal, make ICS a suitable seating solution for both home and contract use. It adapts to all environments, from the most informal to the most sophisticated.

ES Colección polivalente que parte de una carcasa de estructura metálica revestida de poliuretano inyectado de gran resistencia, flexibilidad y ligereza visual. Sus tapizados y el uso de diversos materiales de soporte, como la madera y el metal, hacen de ICS un asiento adecuado para su uso en el hogar y en instalaciones, ya que se adapta a todos los ambientes, desde los más informales hasta los más sofisticados.

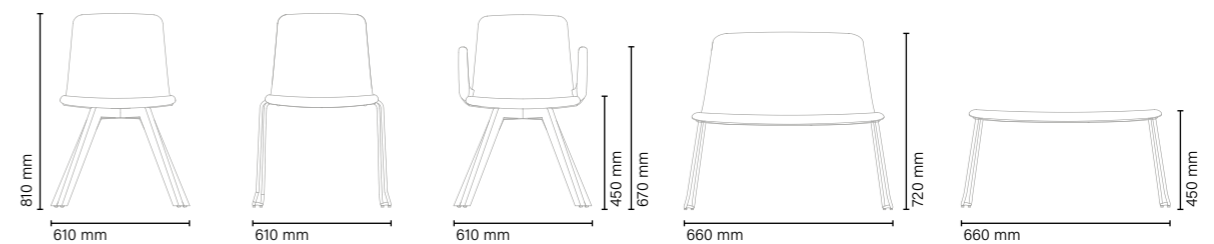

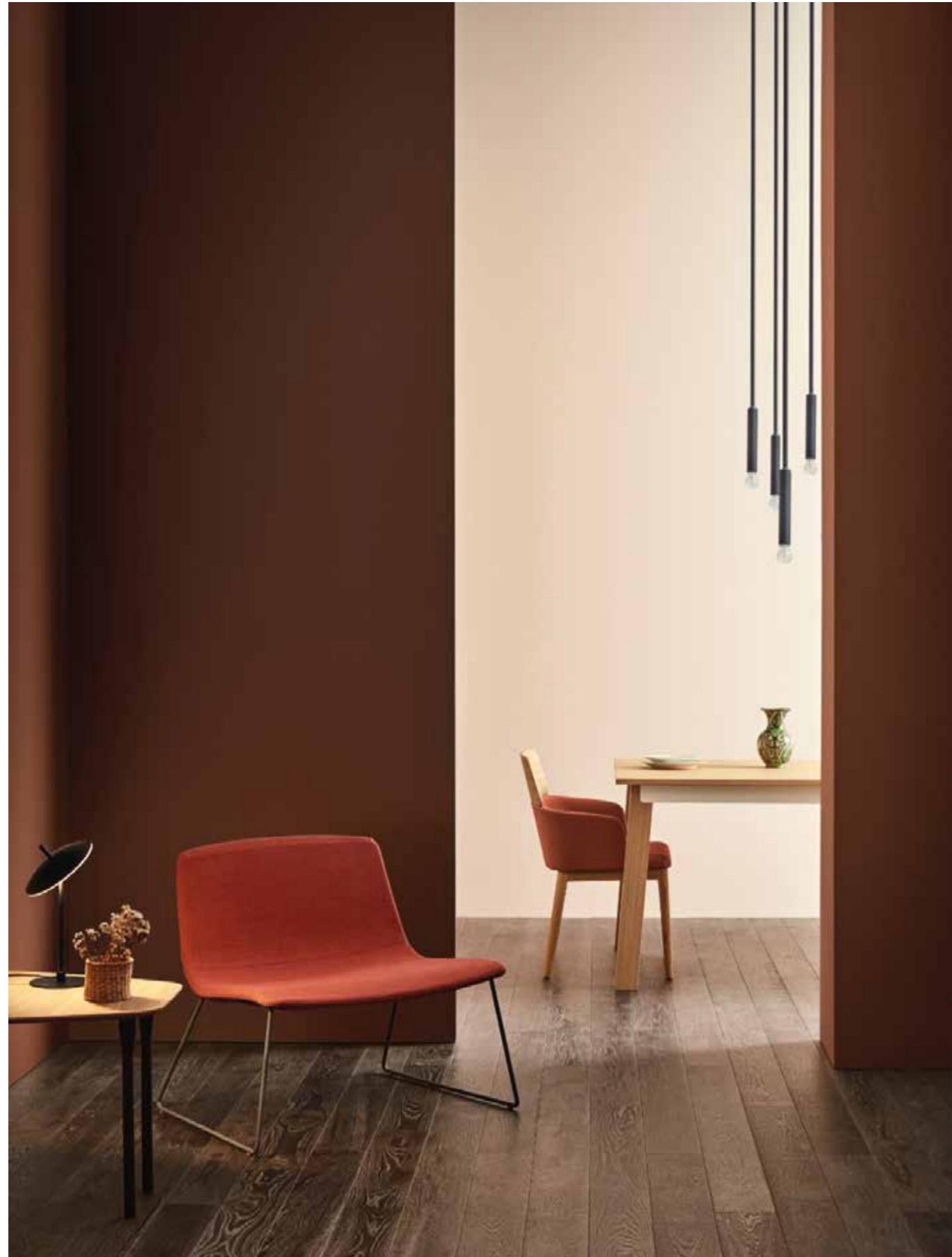

116



117



ICS collection

Chair / Sillas**505MD4**

Upholstered chair with solid beech or oak wood base / Silla tapizada con base de madera maciza de haya o roble

**505PTN**

Chair with sled base in powder-coated steel or chrome finishing / Silla con estructura de patín con varilla de acero recubierta de pintura en polvo o cromada

**506MD4**

Upholstered armchair with solid beech or oak wood base / Sillón tapizada con base de madera maciza de haya o roble

Lounge Chair / Butaca**507PTN**

Lounge chair with sled base in powder-coated steel or chrome finishing / Butaca con estructura de patín con varilla de acero recubierta de pintura en polvo o cromada

Restfoot / Reposapiés**508PTN**

Restfoot with sled base in powder-coated steel or chrome finishing / Reposapiés con estructura de patín con varilla de acero recubierta de pintura en polvo o cromada



120

LEIZU collection

Design by EstudiHac

EN The Leizu Collection draws inspiration from the delicacy and warmth of wool yarn, blending comfort with elegance to create a cozy and sophisticated ambiance.

This range of seating options, including chairs, stools and armchairs, features an ergonomic and inviting design that envelops you in a sense of comfort reminiscent of the comforting embrace of a wool yarn ball.

ES La Colección Leizu está inspirada en la delicadeza y la calidez de los ovillos de lana, esta colección fusiona la comodidad con la elegancia para crear un ambiente acogedor y sofisticado.

Esta línea de asientos, que incluye tanto sillas como butacas y taburetes, ofrece un diseño ergonómico y acogedor, que te envuelve en una sensación de confort que recuerda al abrazo reconfortante de un ovillo de lana.

121

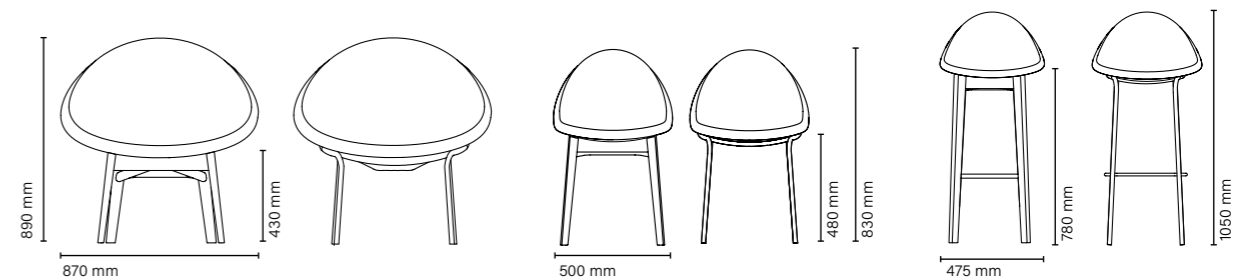



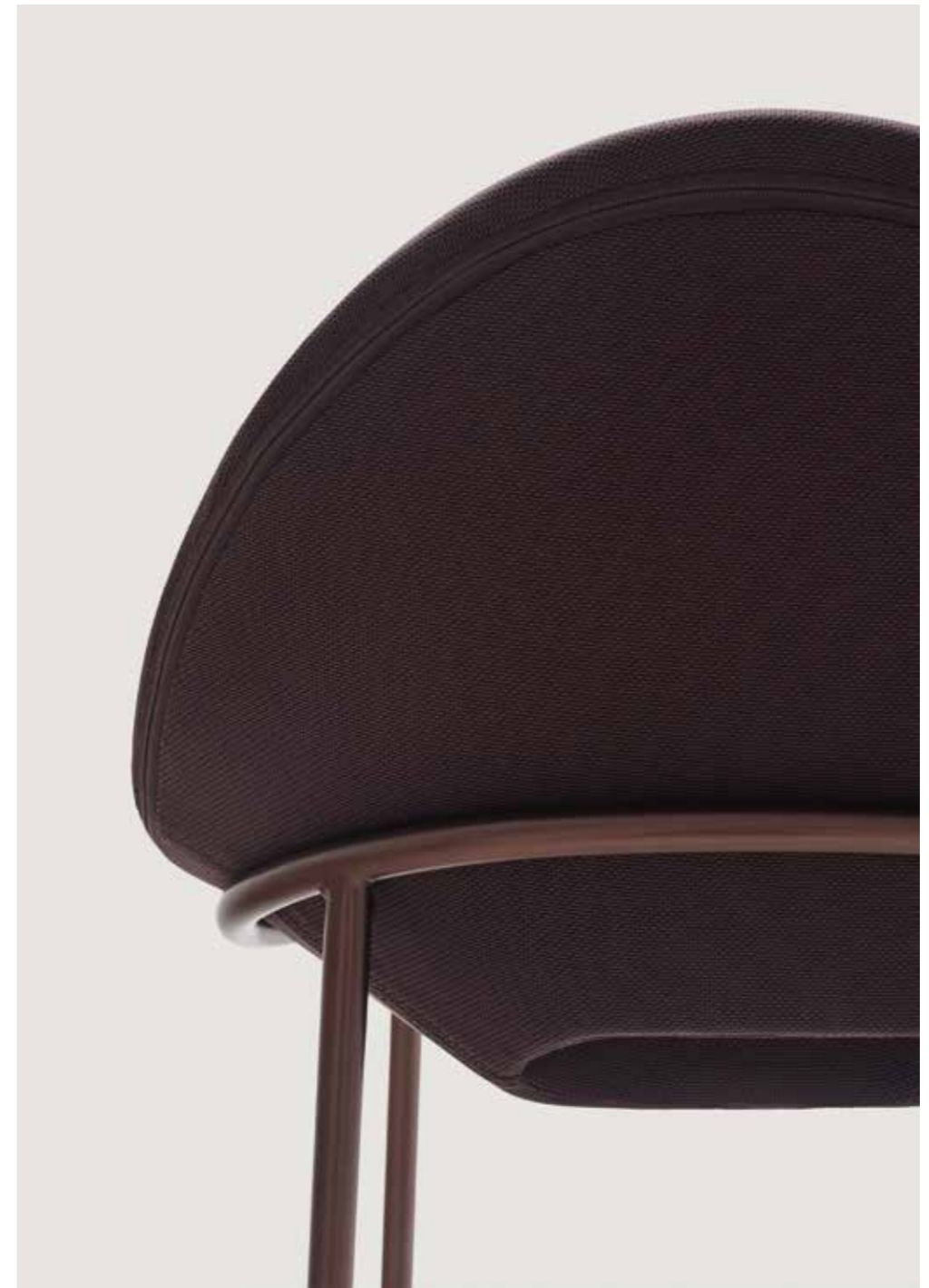



LEIZU collection

Chair / Silla



2411WP
Chair with solid ash wood frame. Upholstered front shell and wooden back shell / Silla con estructura de madera maciza de fresno. Carcasa delantera tapizada y trasera de madera



2411WT
Chair with solid ash wood frame, and upholstered shell / Silla con estructura de madera maciza de fresno, y carcasa tapizada



2411VP
Chair with steel frame. Upholstered front shell and wooden back shell / Silla con estructura de acero. Carcasa delantera tapizada y trasera de madera



2411VT
Chair with steel frame, and upholstered shell / Silla con estructura de acero, y carcasa tapizada

Lounge Chair / Butaca



2415WP
Lounge chair with solid ash wood frame. Upholstered front shell and wooden back shell / Butaca con estructura de madera maciza de fresno. Carcasa delantera tapizada y trasera de madera



2415WT
Lounge chair with solid ash wood frame, and upholstered shell / Butaca con estructura de madera maciza de fresno, y carcasa tapizada



2415VP
Lounge chair with steel frame. Upholstered front shell and wooden back shell / Butaca con estructura de acero. Carcasa delantera tapizada y trasera de madera



2415VT
Lounge chair with steel frame, and upholstered shell / Butaca con estructura de acero, y carcasa tapizada

Stool / Taburete



2419WP
Stool with solid ash wood frame. Upholstered front shell and wooden back shell / Taburete con estructura de madera maciza de fresno. Carcasa delantera tapizada y trasera de madera



2419WT
Stool with solid ash wood frame, and upholstered shell / Taburete con estructura de madera maciza de fresno, y carcasa tapizada



2419VP
Stool with steel frame. Upholstered front shell and wooden back shell / Taburete con estructura de acero. Carcasa delantera tapizada y trasera de madera



2419VT
Stool with steel frame, and upholstered shell / Taburete con estructura de acero, y carcasa tapizada



LOOP collection

Design by Patrick Norguet

EN The Loop collection has been designed to deliver maximum comfort. With ergonomic shapes that perfectly adapt to the natural curve of the back, it is an ideal choice for a task chair. Loop is a versatile family of chairs offering a wide range of customizable options, making it suitable for all kinds of spaces: work environments, residential settings, restaurants, and collaborative spaces.

It features a high or low upholstered wooden shell, available with three different base options, with or without arms. The shell upholstery can be soft or traditional, and the arms can be finished in metal or upholstered.

ES La colección Loop ha sido concebida para proporcionar un confort máximo. Diseñada con formas ergonómicas que se adaptan perfectamente al contorno de la espalda, siendo perfecta como silla de trabajo. Loop es una familia de sillas con una gran variedad de opciones personalizables. Pensada para todo tipo de espacios: entornos de trabajo, residencial, restaurantes y cualquier espacio colaborativo.

Está compuesta por una carcasa de madera alta o baja tapizada disponible en tres bases a elegir con o sin brazos. El tapizado de la carcasa puede ser soft o tradicional y los brazos, metálicos o tapizados.

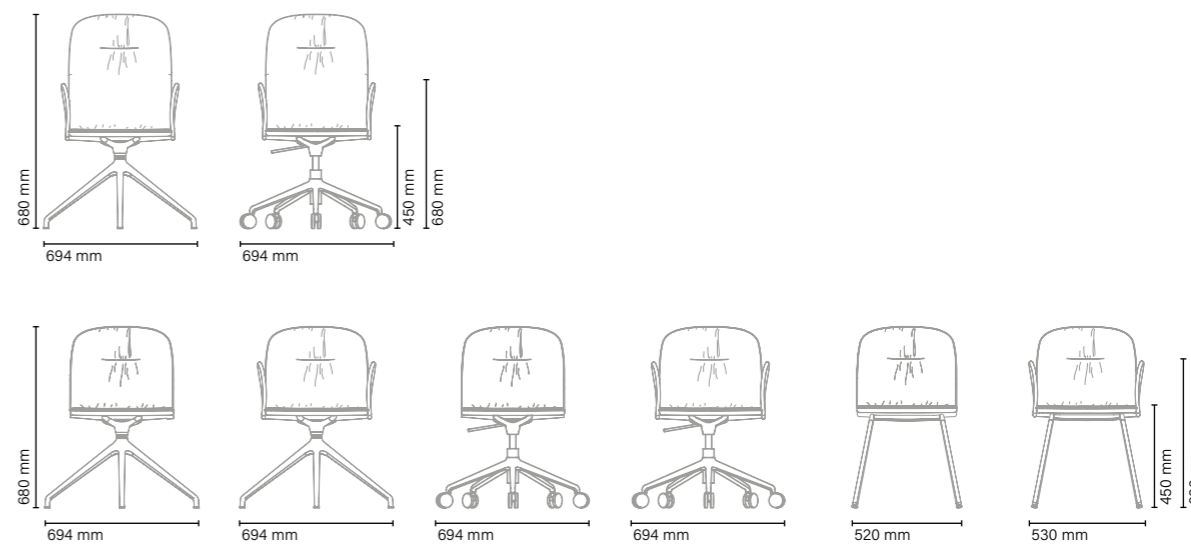



130

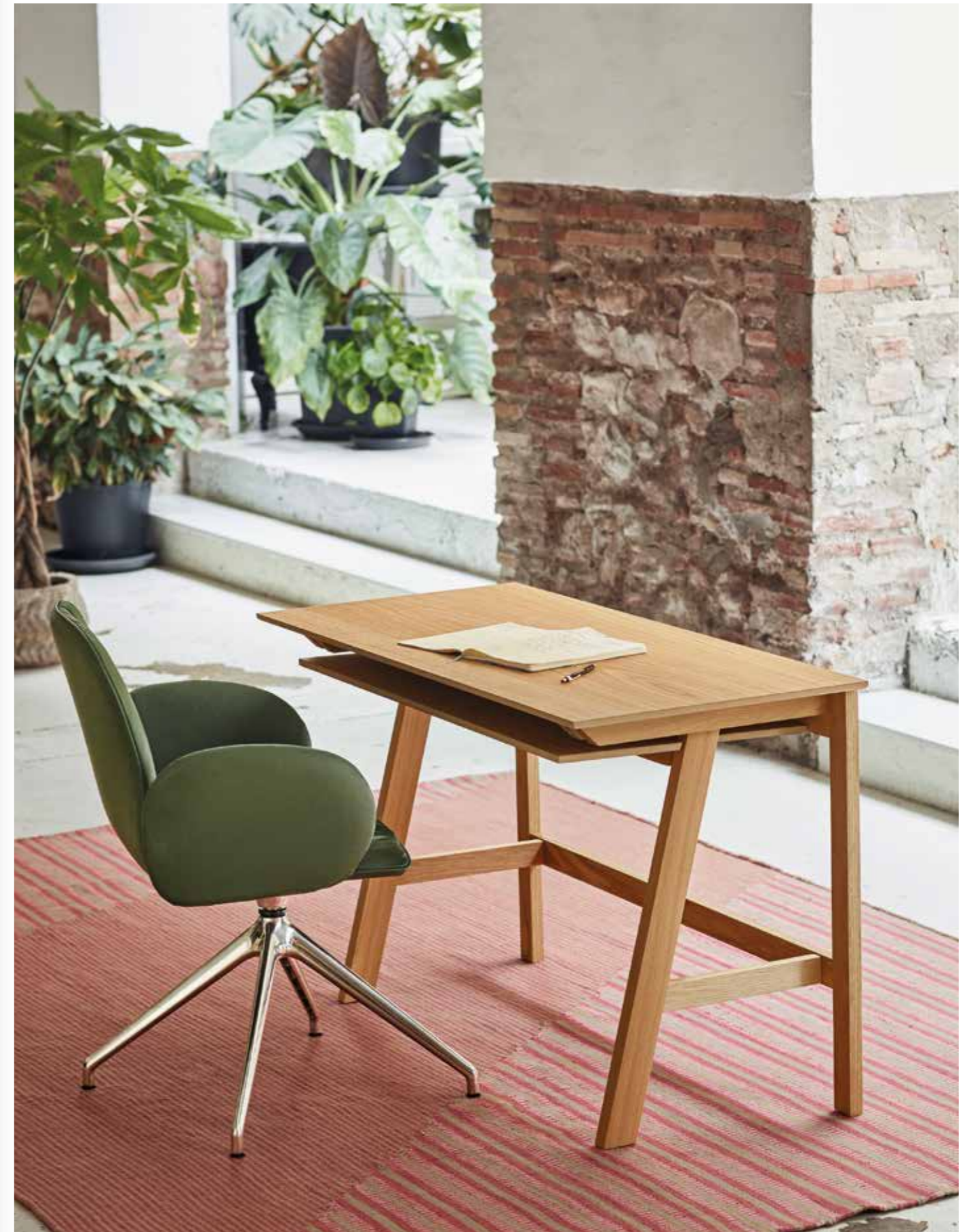

131



132



133



134

LOOP collection

Chair / Sillas

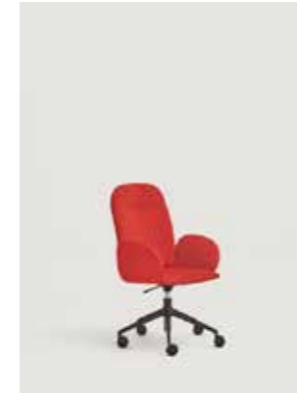
**2131DRNT**

Upholstered armchair with swivel aluminium base. Fitted with castor wheels / Sillón tapizado con base de aluminio con sistema giratorio. Equipada con ruedas

**2131DRN**

Upholstered armchair with metal arms and swivel aluminium base. Fitted with castor wheels / Sillón tapizado con brazos de metal y base de aluminio con sistema giratorio. Equipada con ruedas

**2131DNT**

Upholstered armchair with swivel aluminium base / Sillón tapizado con base de aluminio con sistema giratorio

**2131DN**

Upholstered armchair with metal arms and swivel aluminium base / Sillón tapizado con brazos de metal y base de aluminio con sistema giratorio

**2130DNT**

Upholstered armchair with swivel aluminium base / Sillón tapizado con base de aluminio con sistema giratorio

**2130DN**

Upholstered armchair with metal arms and swivel aluminium base / Sillón tapizado con brazos de metal y base de aluminio con sistema giratorio

**2130D**

Upholstered chair with and swivel aluminium base / Silla tapizada y base de aluminio con sistema giratorio

**2130DRNT**

Upholstered armchair with swivel aluminium base. Fitted with castor wheels / Sillón tapizado con base de aluminio con sistema giratorio. Equipada con ruedas

**2130DRN**

Upholstered armchair with metal arms and swivel aluminium base. Fitted with castor wheels / Sillón tapizado con brazos de metal y base de aluminio con sistema giratorio. Equipada con ruedas

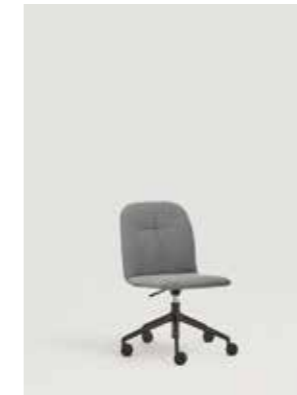
**2130DR**

Upholstered chair with metal arms and swivel aluminium base. Fitted with castor wheels / Silla tapizada y base de aluminio con sistema giratorio. Equipada con ruedas

**2130VN**

Upholstered armchair with metal arms and legs / Sillón tapizado con brazos y base de metal

**2130VNT**

Upholstered armchair with metal legs / Sillón tapizado con base de metal

135



136

MARIETTA collection

Design by Yonoh

EN Marietta is a collection with a very fresh and customizable design that leaves no one indifferent. Its name comes from valencian, its translation is Mariquita, referring to the insect from which the design is inspired and emphasizing the local culture. A very funny aesthetic, seen from above, the structure, the seat and the backrest imitate the shape of this little insect, legs, body, head...

The collection consists of a chair, armchair, armchair and stool. It is stackable and has a version for outdoor spaces

ES Marietta es una colección con un diseño muy fresco y personalizable, que no deja indiferente a nadie. Su nombre proviene del valenciano, su traducción es Mariquita, haciendo referencia al insecto en el que se inspira el diseño y poniendo el énfasis en la cultura local. Una estética muy divertida, visto desde arriba, la estructura, el asiento y el respaldo imitan la forma de este pequeño insecto, patas, cuerpo, cabeza...

La colección se compone de silla, sillón, butaca y taburete. Es apilable y tiene una versión para espacios exteriores

137

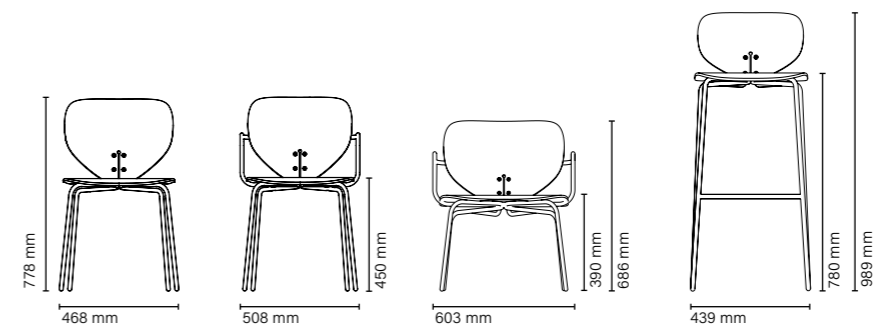

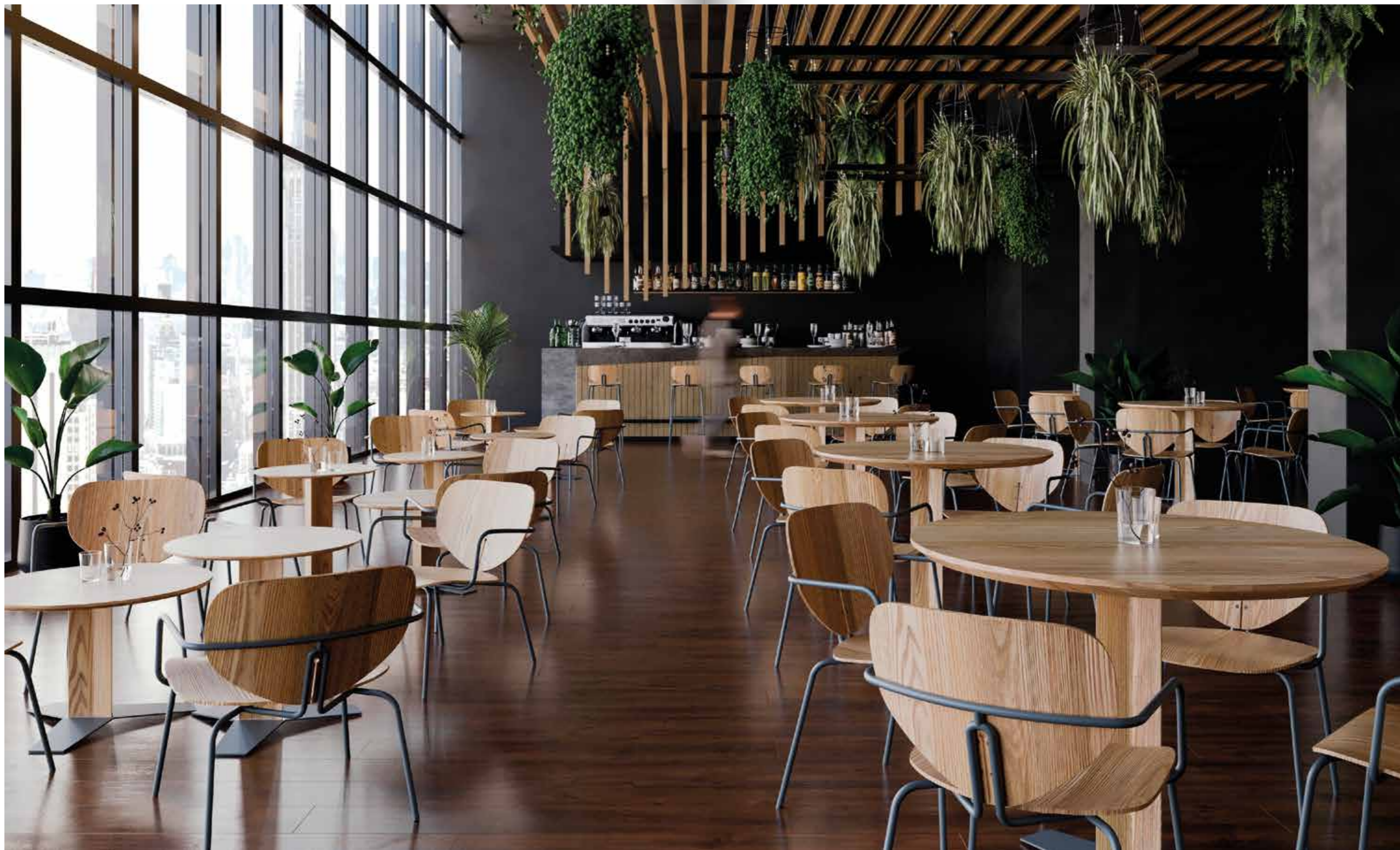

138

139





142

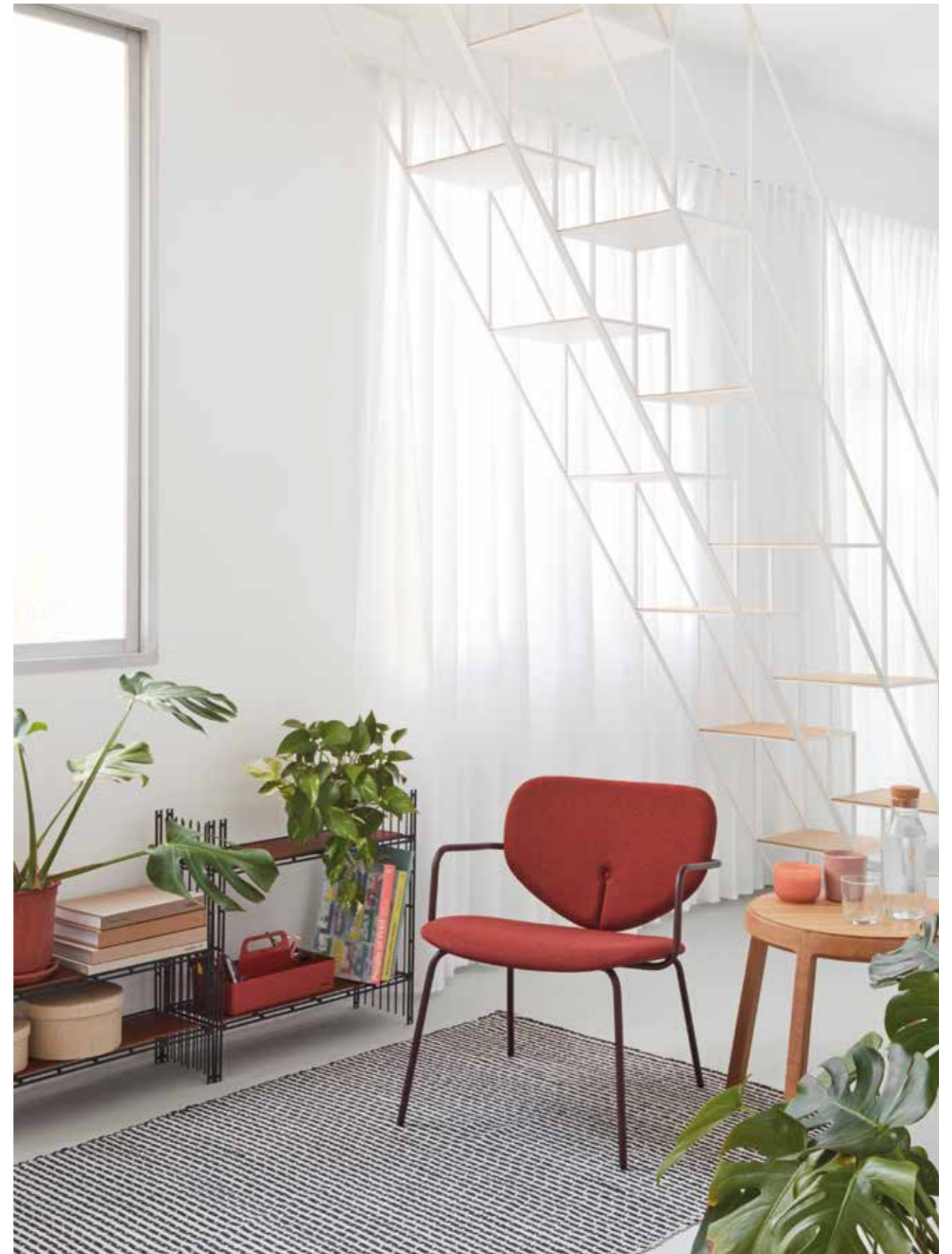

143



MARIETTA collection

Chair / *Sillas*

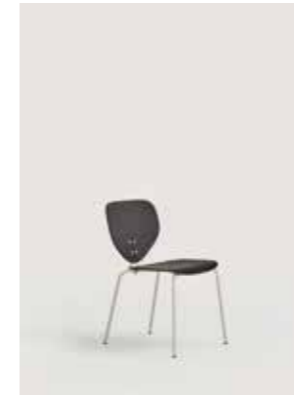

2311
Chair with oak wood seat and back.
Steel frame / *Silla con asiento y respaldo de roble. Estructura de acero*



2311N
Armchair with oak wood seat and back.
Steel frame / *Silla con brazos con asiento y respaldo de roble. Estructura de acero*



2311U
Upholstered chair with steel frame / *Silla tapizada con estructura de acero*



2311U-N
Upholstered armchair with steel frame / *Silla tapizada con brazos con estructura de acero*

Outdoor / *Exterior*



2311INOX
Outdoor chair with aluminium seat and back. Inoxidable steel frame / *Silla de exterior con asiento y respaldo de aluminio. Estructura de acero inoxidable*



2311INOX-N
Outdoor armchair with aluminium seat and back. Inoxidable steel frame / *Silla de exterior con brazos con asiento y respaldo de aluminio. Estructura de acero inoxidable*



2315
Lounge chair with oak wood seat and back. Steel frame / *Butaca con asiento y respaldo de roble. Estructura de acero*



2315U
Upholstered lounge chair with steel frame / *Butaca tapizada con estructura de acero*

Stool / *Taburete*



2319
Stool with oak wood seat and back. Steel frame / *Taburete con asiento y respaldo de roble. Estructura de acero*



2319U
Upholstered stool with steel frame / *Taburete tapizado con estructura de acero*



146

MARTA collection

Design by Gabriel Teixidó

EN The Marta collection is born from a deep respect for wood. Its subtle design, light appearance and marked natural character make it suitable for very diverse environments.

Manufactured in a traditional way, its design with exposed interlocked joints is articulated around a beech wood structure combined with straps that provide strength and lightness at the same time to each piece.

Chairs, armchairs and low seats where you can caress and smell the wood. A magical experience where the material and the object merge.

ES La colección Marta nace de un profundo respeto por la madera. Su diseño sutil, apariencia liviana y un marcado carácter natural hace que se pueda disponer en ambientes muy diversos.

Fabricada de manera tradicional, su diseño con uniones trabadas vistas, se articula en torno a una estructura de madera de haya combinada con cinchas que aportan solidez y al mismo tiempo, levedad a cada pieza.

Sillas, sillones y butacas bajas donde poder acariciar y oler la madera. Una experiencia mágica en la cual el material y el objeto se funden.

147

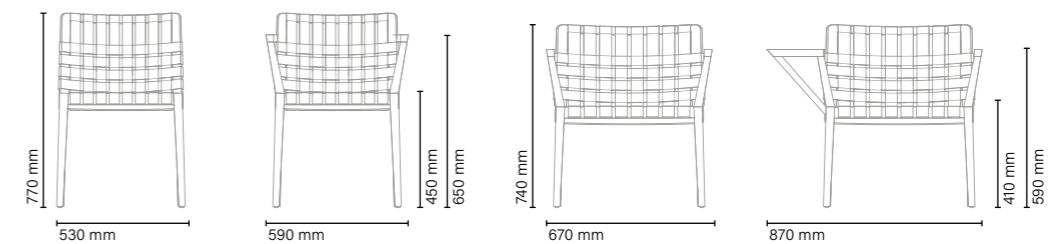



148

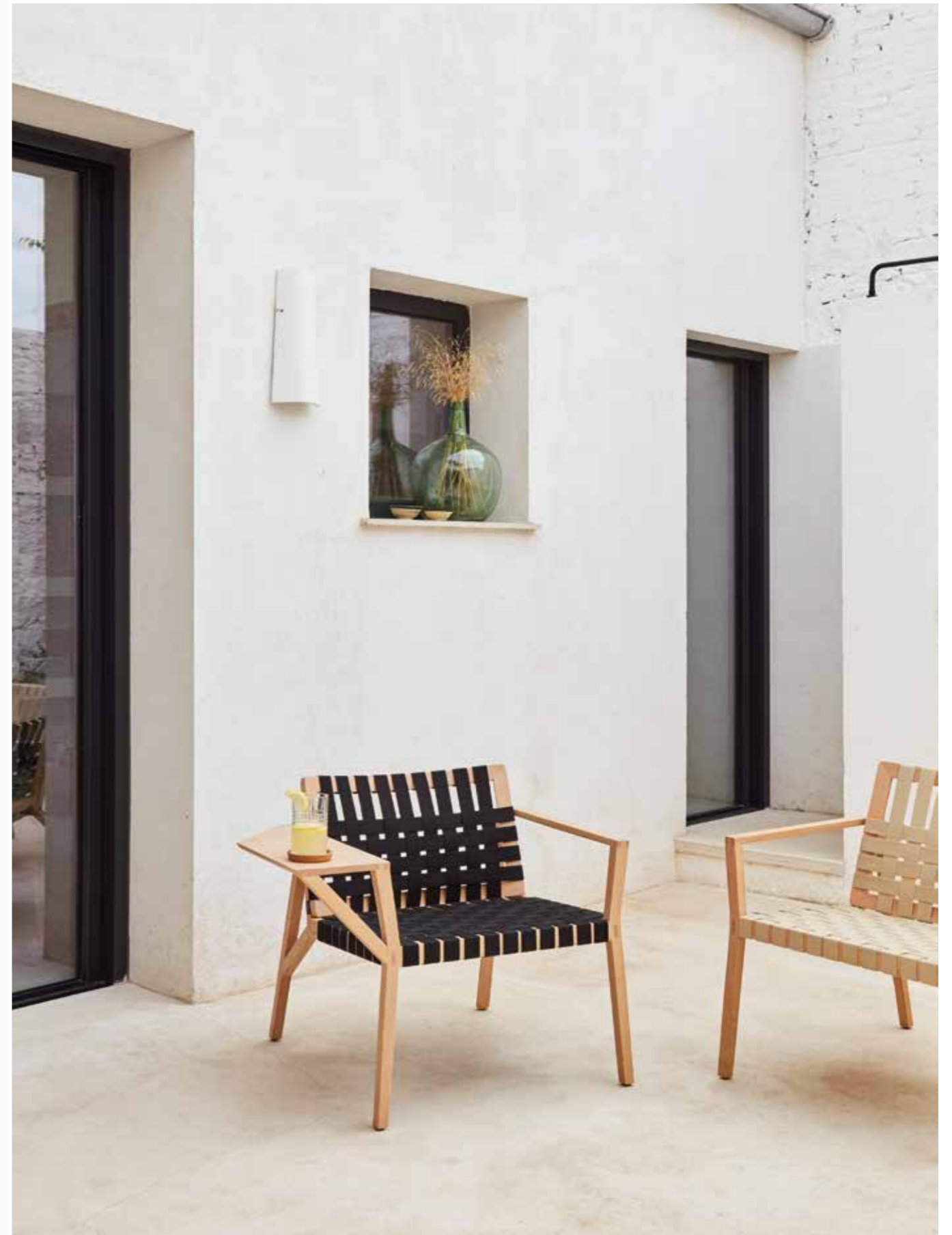

149



150



151



MARTA collection

Chair / Sillas



240CC

Chair with solid beech base and cotton strap seat and back / Silla con estructura de madera de haya y asiento y respaldo con cinchas de algodón

Armchair / Sillón



241CC

Armchair with solid beech base and cotton strap seat and back / Sillón con estructura de madera de haya y asiento y respaldo con cinchas de algodón

Lounge Chair / Butaca



243CC

Lounge chair with solid beech base and cotton strap seat and back / Butaca con estructura de madera de haya y asiento y respaldo con cinchas de algodón



244CC

Lounge chair with table. Solid beech base and cotton strap seat and back / Butaca con mesa. Estructura de madera de haya y asiento y respaldo con cinchas de algodón



MATCH collection

Design by Patrick Norguet

EN The MATCH chair combines two materials: solid wood and plywood paired with metal.

MATCH showcases a striking and unique design, based on a subtle balance between wood and metal. The rear legs are made of solid wood, while the front legs are metal. The shape of the seat and backrest ensures both ergonomics and comfort.

Designed for public and residential spaces, it is available in two versions: upholstered seat and backrest, or upholstered seat with a wooden backrest.

ES La silla MATCH es una combinación de dos materiales; madera maciza y contrachapado junto con metal.

MATCH muestra una arquitectura sorprendente y singular, basada en un sutil desequilibrio entre madera y metal. Las patas traseras están hechas de madera maciza y las delanteras de metal. La forma del asiento y el respaldo aseguran la ergonomía y el confort.

Destinado a espacios públicos y residenciales. Está disponible en dos versiones: respaldo y asiento tapizados o asiento tapizado y respaldo de madera.

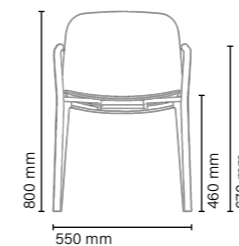



156

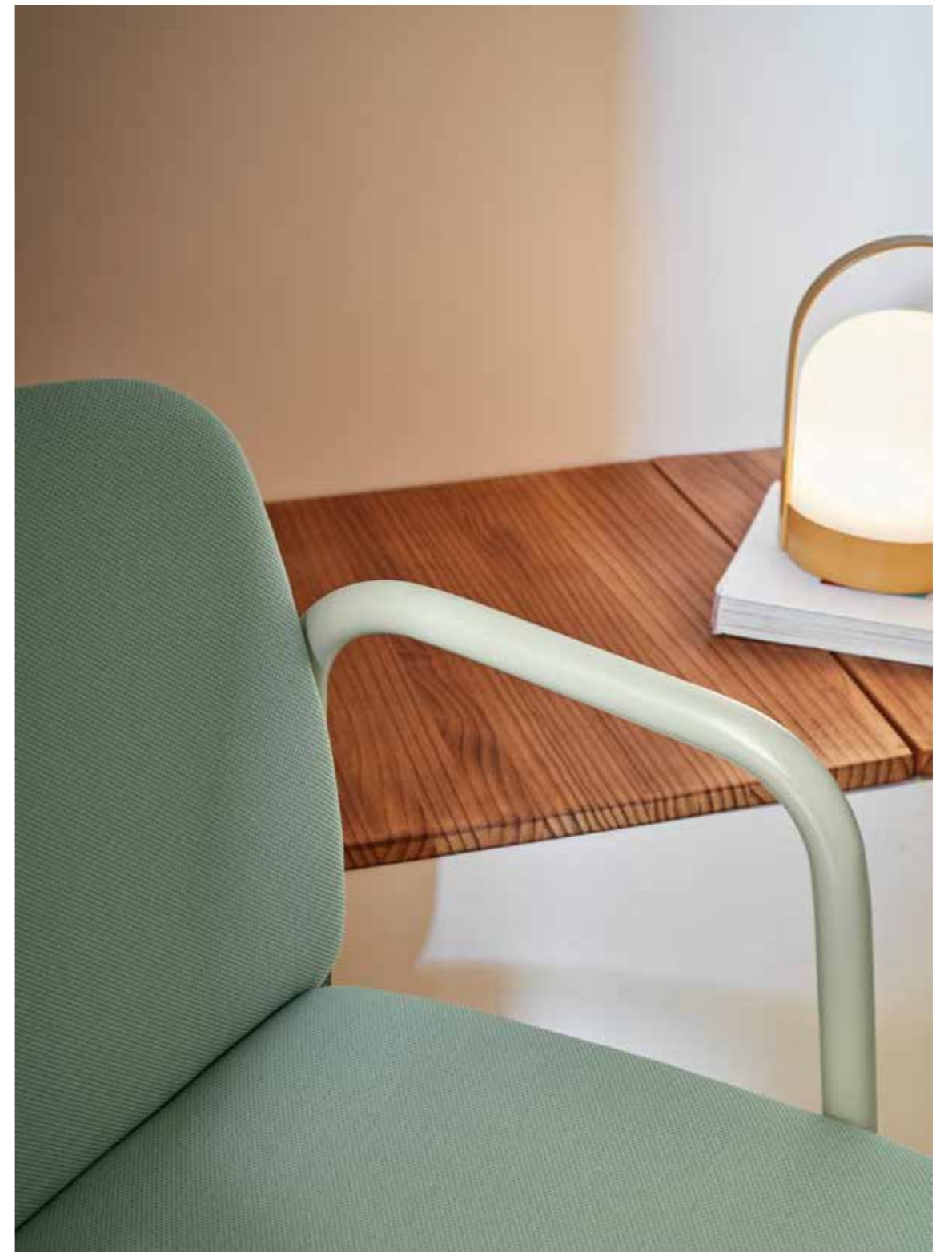

157



158



159



MATCH collection

Armchair / *Sillón*



2021PM

Armchair with oak wood shell and back legs. Steel front legs. Upholstered seat / *Sillón con respaldo y patas trasera de roble. Patas delanteras de acero. Asiento tapizado*



2021PP

Armchair with oak wood shell and back legs. Steel front legs. Upholstered seat and back / *Sillón con respaldo y patas trasera de roble. Patas delanteras de acero. Asiento y respaldo tapizados*



162

MOON collection

Design by Gabriel Teixidó

EN Multifunctionality is one of the characteristics of the MOON collection. A highly resistant polyurethane-coated seat shell, together with the upholstery and the use of various support materials, such as wood (beech or oak) or metal, make the Moon chairs suitable for the home or for other spaces.

Their common denominator: comfort and aesthetics.

ES La multifuncionalidad es una de las características de la colección MOON. Una carcasa de asiento revestida de poliuretano de gran resistencia, junto a la tapicería y el uso de diversos materiales de soporte, como la madera (haya o roble) o el metal hacen que las sillas Moon sean apropiadas para el hogar o para otros espacios.

Su denominador común: comodidad y estética.

163

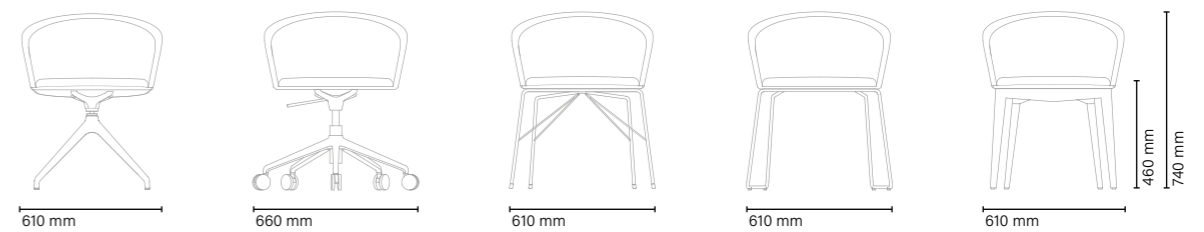

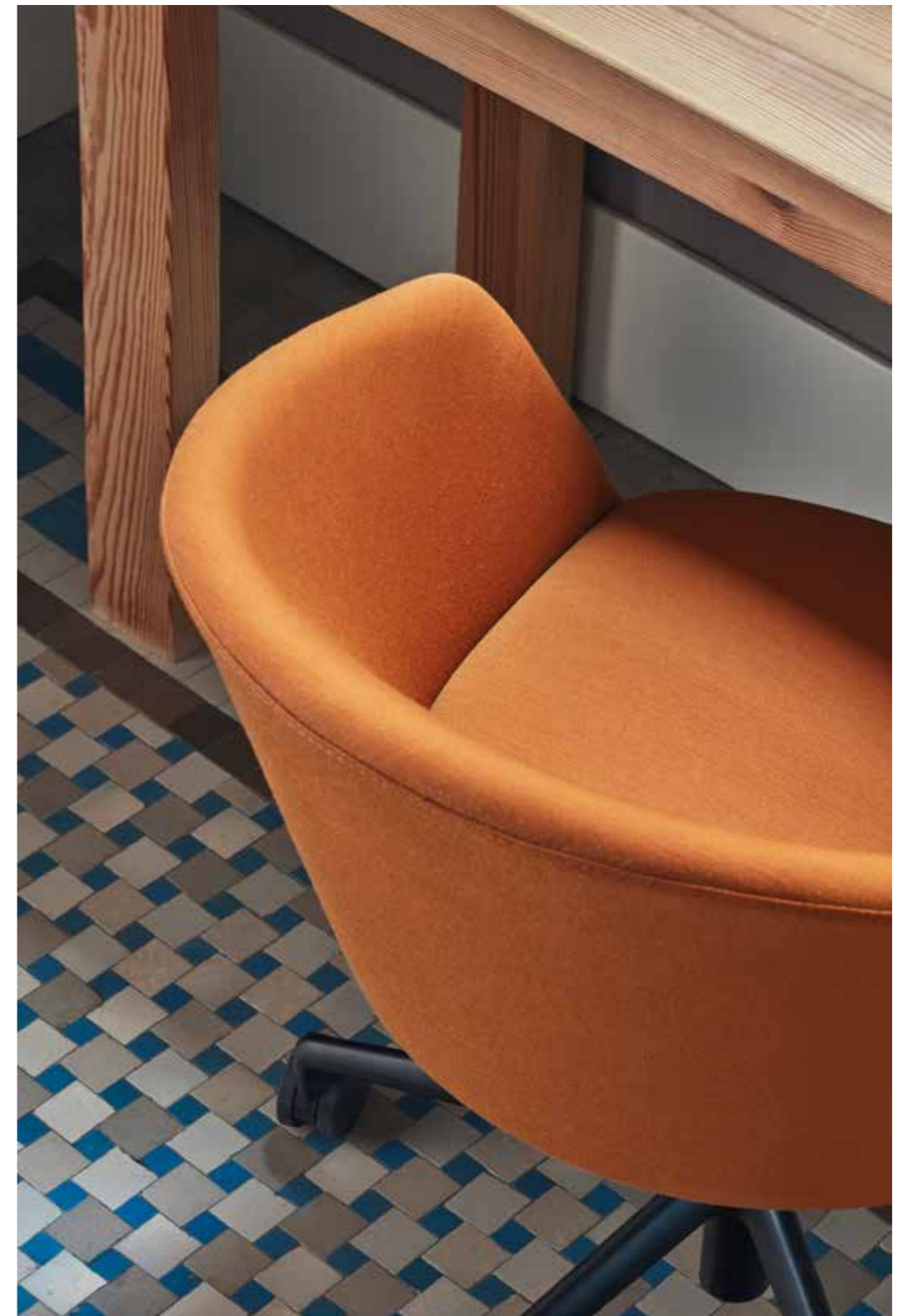

164

165



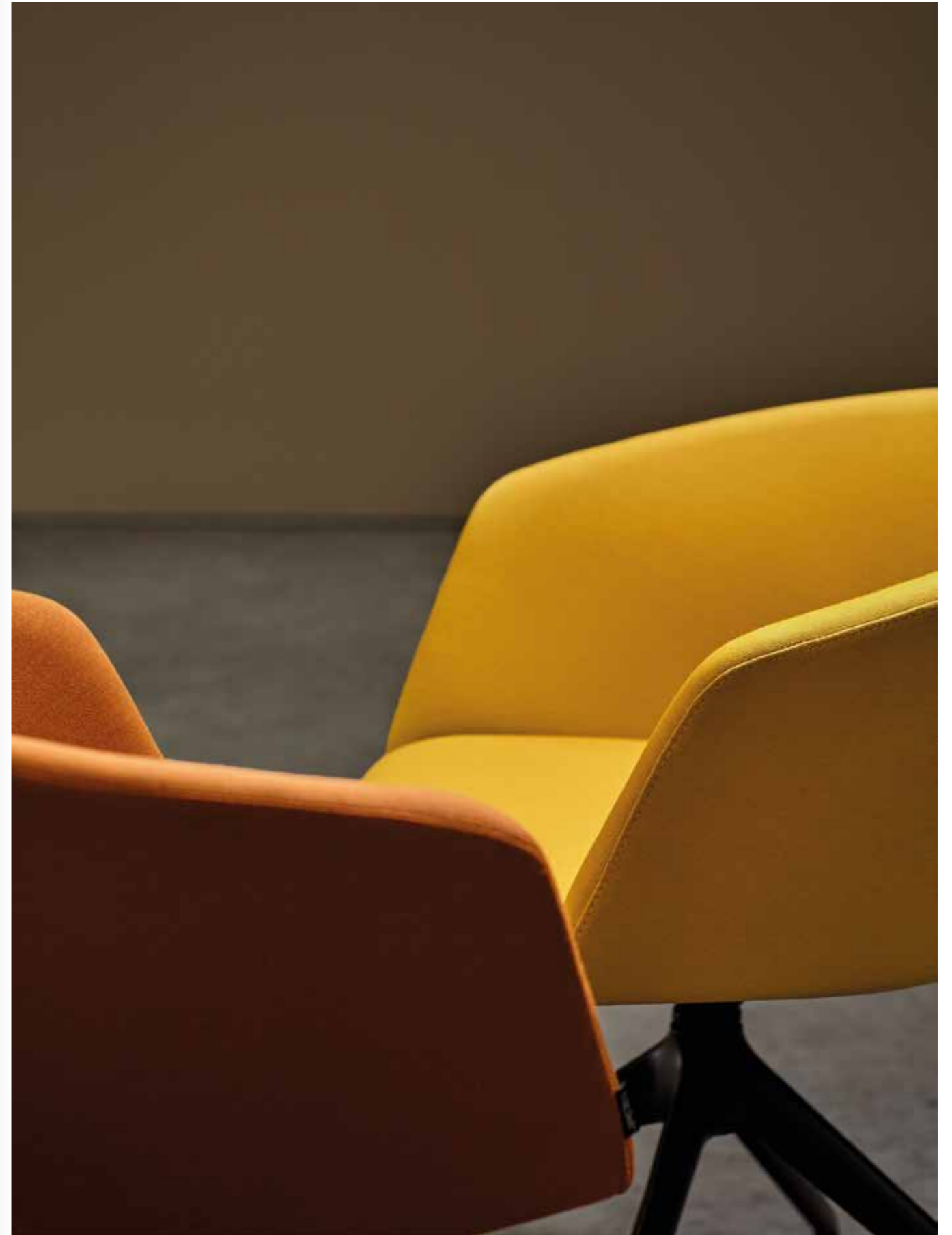



MOON collection

Chair / Sillas**663D**

Upholstered chair with four way swivel aluminium base / Silla tapizada con base de aluminio con sistema giratorio y cuatro radios

**663DR**

Upholstered chair with swivel aluminium base. Fitted with castor wheels / Silla tapizada con base de aluminio con sistema giratorio. Equipada con ruedas

**663MD4**

Upholstered chair with solid beech or oak wood base / Silla tapizada con base de madera maciza de haya o roble

**663TNS**

Upholstered chair with solid steel structure / Silla con estructura de varilla de acero con tensor

**663PTN**

Upholstered chair with solid steel structure / Silla con estructura de varilla de acero con tensor

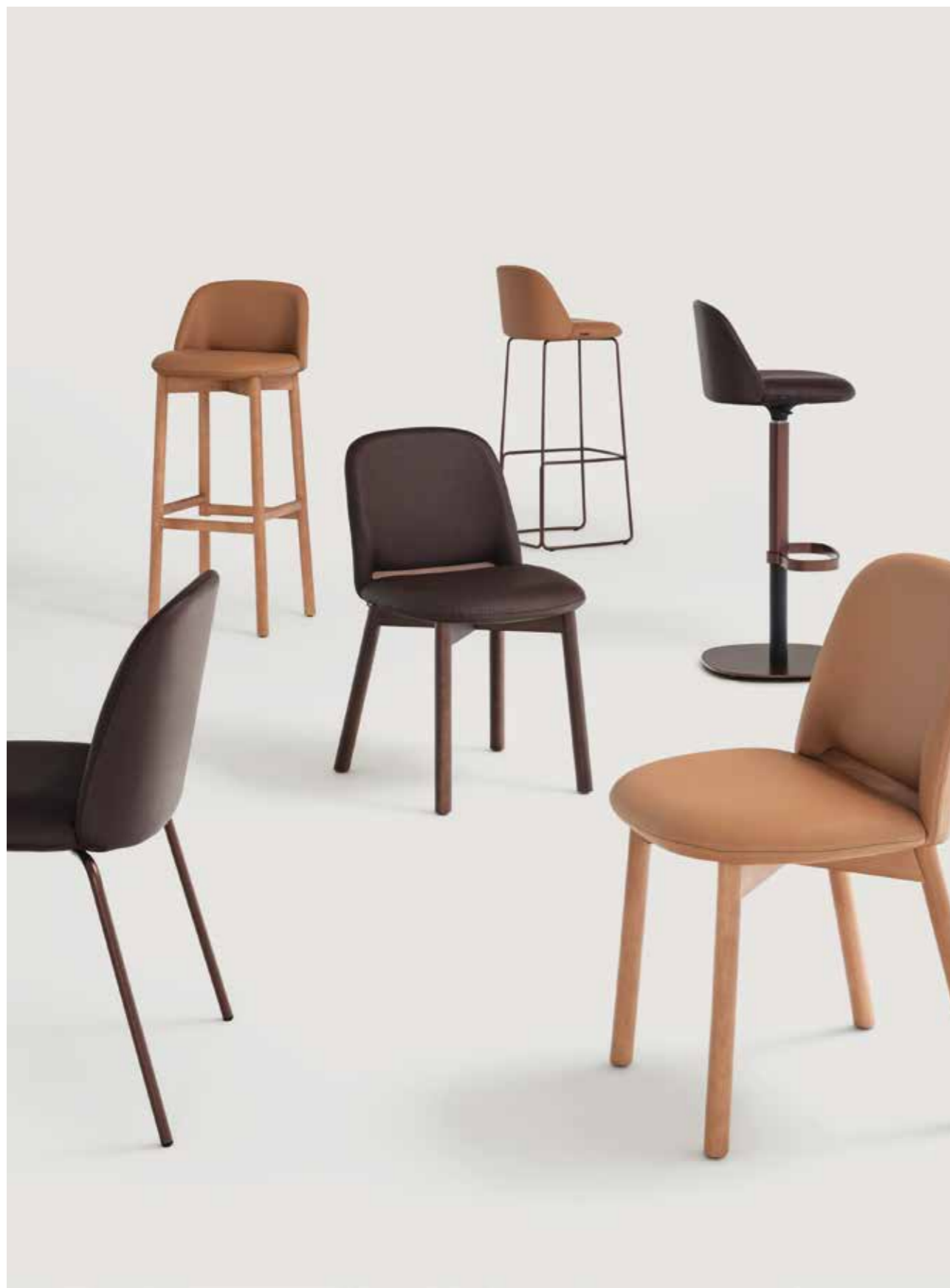

172

NARA collection

Design by Mario Ruiz

EN Family of three types of stools and two types of chairs. A stool with a liftable piston. The base piece of the leg hugs the column and gives uniqueness to the product. The rod option is also available and of course solid wood. All options are sized to create a harmonious set between base and seat. It has a marked symmetrical character, since all its curves are balanced on both axes. The seat has ergonomic curvature that adapts to the shapes of the body, providing comfort and comfort when sitting.

ES Familia de tres tipos de taburetes y dos sillas. Un taburete con pistón elevable. La pieza base de la pata abraza la columna y le da singularidad al producto. También está disponible la opción de varilla y por supuesto de madera maciza. Todas las opciones están dimensionadas para que generen un conjunto armonioso entre base y asiento. Tiene un marcado carácter simétrico, ya que todas sus curvas se equilibran en ambos ejes. El asiento tiene curvatura ergonómica que se adapta a las formas del cuerpo aportando comodidad y confort en la sentada.

173

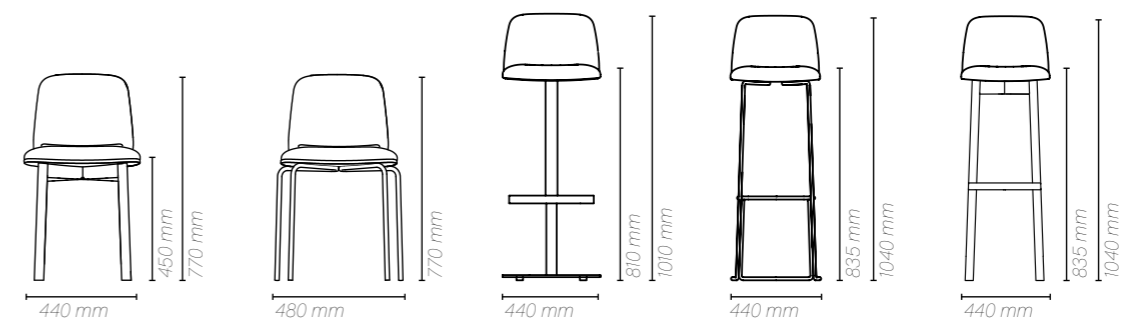

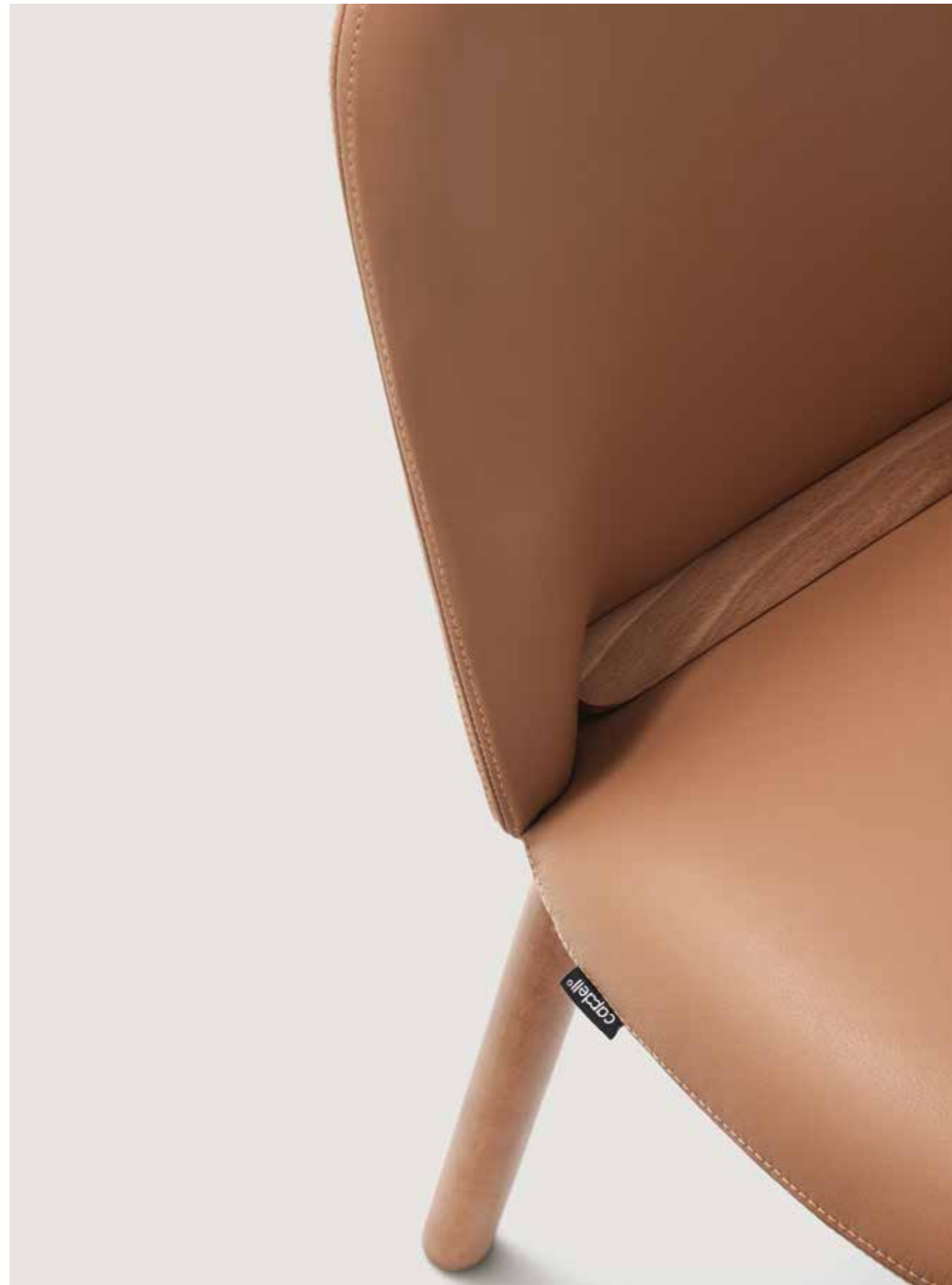

174

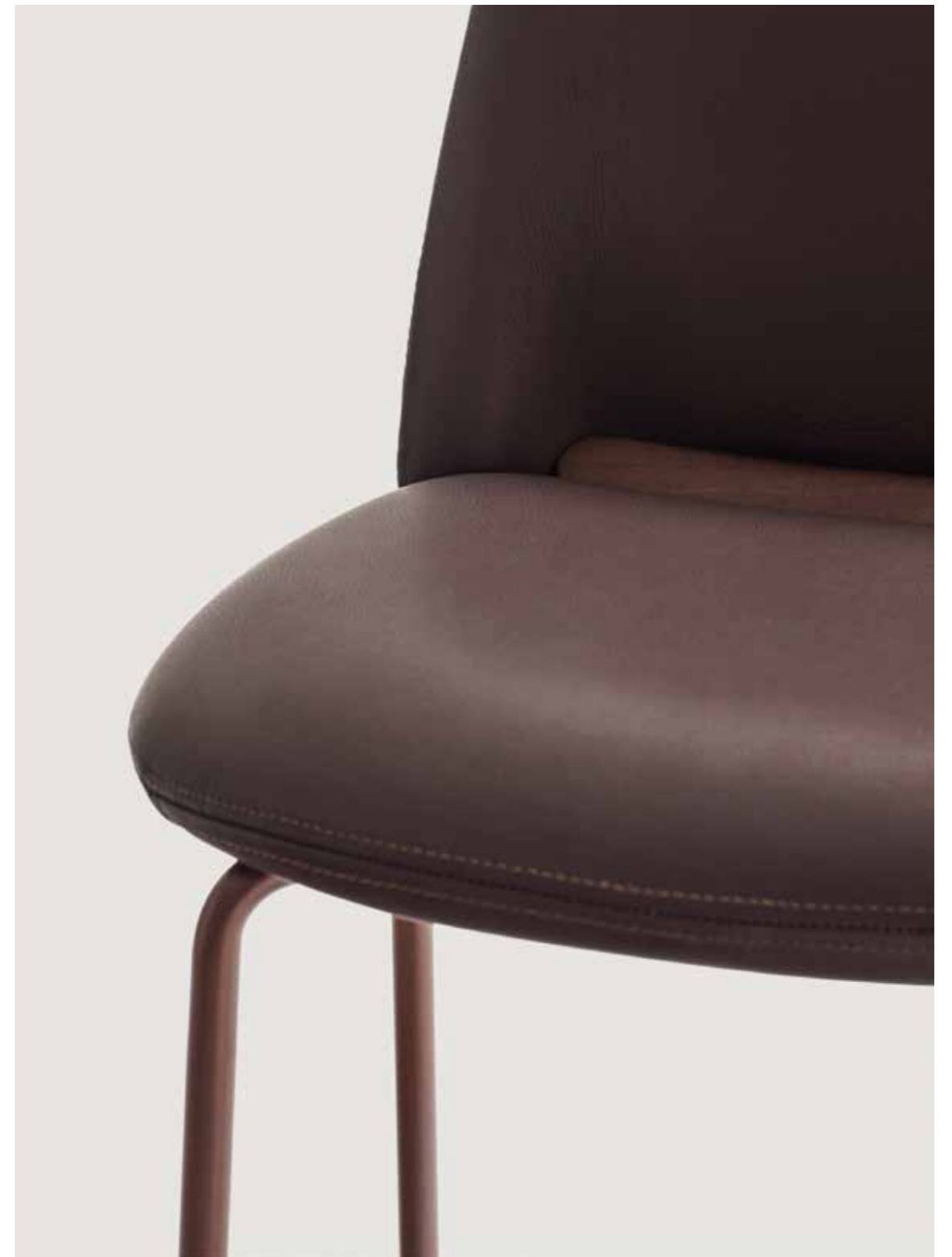

175



176



177

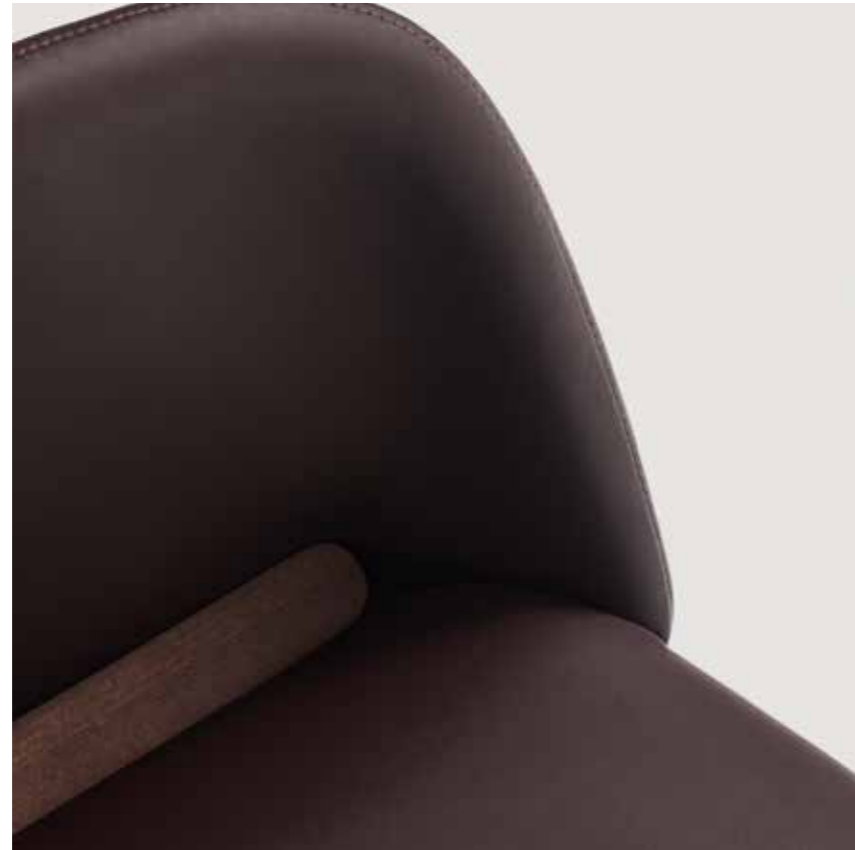

178

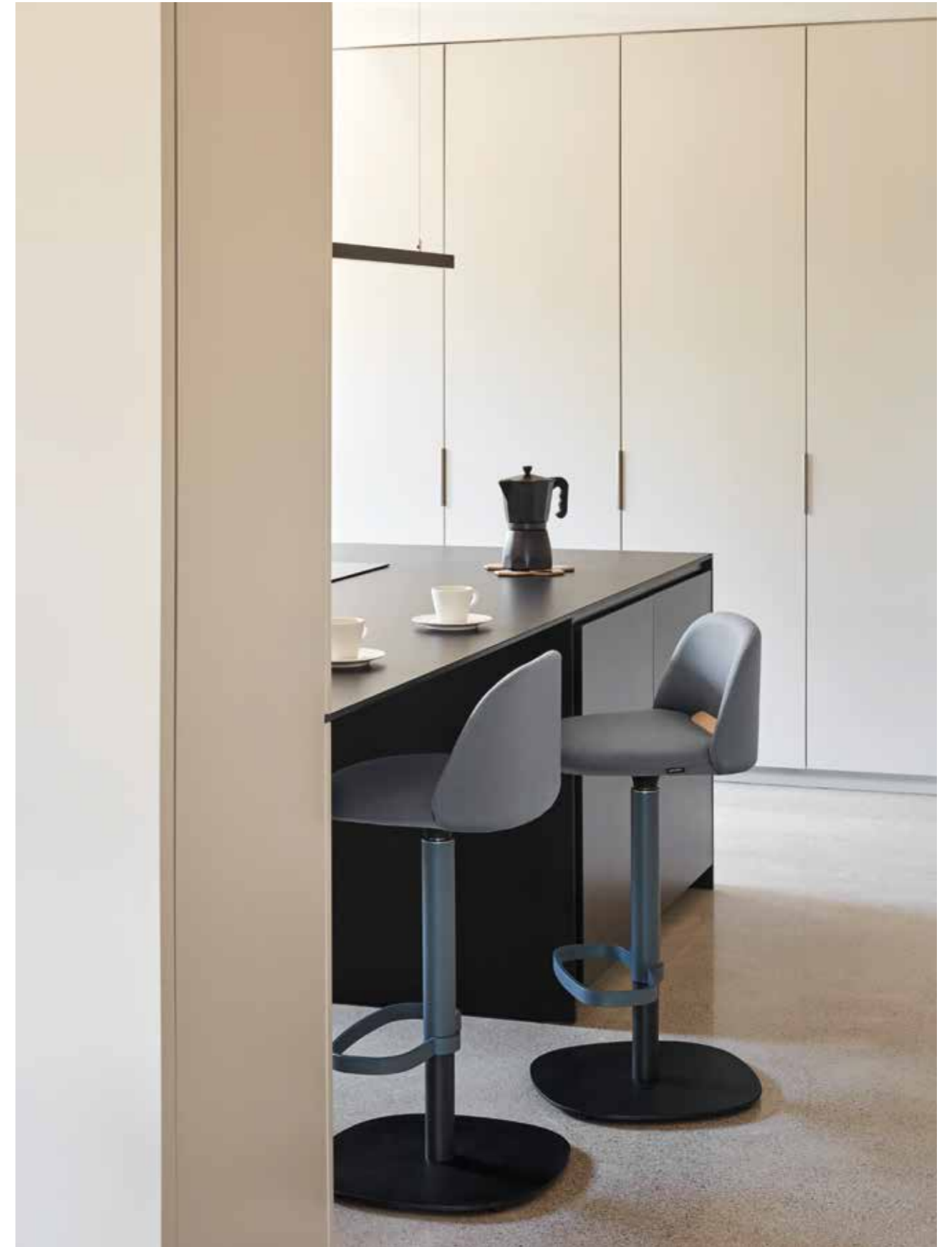

179



NARA collection

Chair / Silla



2201

Upholstered chair with solid beech wood frame / Silla con estructura de madera de haya maciza tapizada



2202

Upholstered chair with steel frame / Silla con estructura de acero tapizada

Stool / Taburete



2209P

Upholstered stool with gas swivel base, adjustable height / Taburete tapizado con base de pistón, altura regulable



2209V

Upholstered stool with solid steel structure. Available in 65 cm height / Taburete tapizado con base de varilla. Disponible de 65 cm



2209M

Upholstered stool with solid beech wood frame. Seat height: 65 or 78 cm / Taburete tapizado con estructura de madera de haya maciza. Altura de asiento de 65 o 78 cm



NIX collection

Design by Patrick Norguet

EN Nix, an iconic design that combines the work of solid wood and the curved plywood 3D spherical geometry. The result is very comfortable and lends itself to both multiple uses of the house as to the collective spaces.

The principle of assembly draws an elegant and singular architecture.

The Nix collection is growing with the introduction of its stool version NIX STOOL.

A contemporary collection with different finishes and colors whose chair was the winner of the prestigious Red Dot Award, 2019.

ES Nix, un diseño icónico que combina el trabajo de la madera sólida y el contrachapado curvado de geometría esférica 3D. El resultado es una silla muy cómoda que se presta tanto a múltiples usos de la casa como a los espacios colectivos.

El principio del ensamblaje, dibuja una arquitectura elegante y singular.

La colección Nix crece con la introducción de su versión taburete NIX STOOL.

Una colección contemporánea con diferentes acabados y colores cuya silla fue ganadora del prestigioso Red Dot Award, 2019.

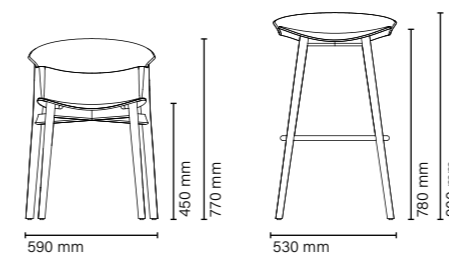



184

185



186

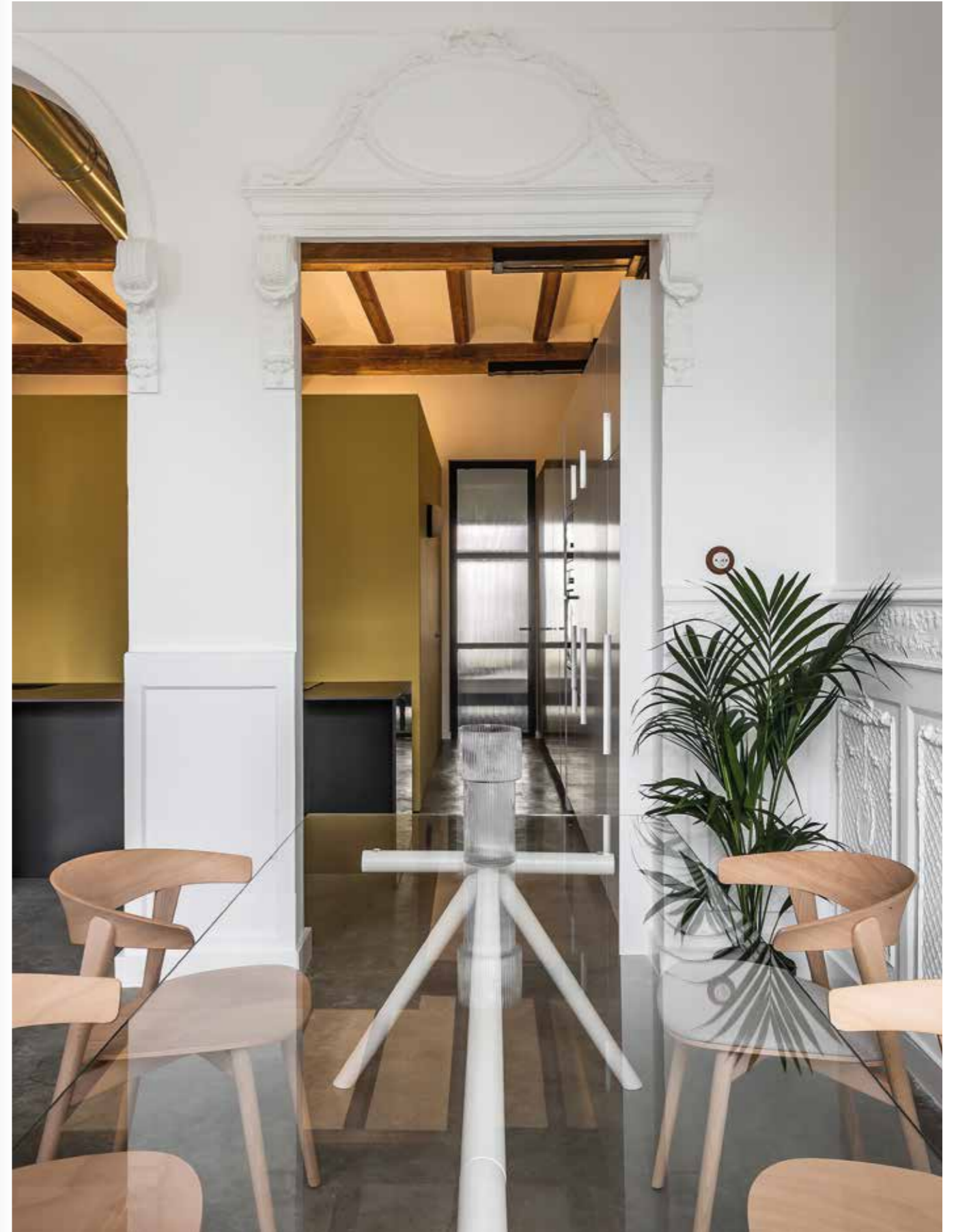

187



188



189



NIX collection

Chair / Sillas



230M

Chair with beech wood base and curved plywood backrest / Silla con estructura de haya y respaldo contrachapado curvado



230P

Upholstered chair with beech wood base and curved plywood backrest / Silla tapizada con estructura de haya y respaldo contrachapado curvado

Stool / Taburete



230M

Stool with beech wood base and curved plywood backrest / Taburete con estructura de haya y respaldo contrachapado curvado



230P

Upholstered stool with beech wood base and curved plywood backrest / Taburete tapizado con estructura de haya y respaldo contrachapado curvado



PANEL collection

Design by Lucy Kurrein

EN Panel is a lounge chair made from sheet steel and tailored wool or leather with exposed edges - a hollow chair rather than a solid one - a light alternative to material-heavy upholstered furniture.

Shape and comfort have been built directly into a seat made of wool or leather through its carefully contoured surface.

The flat section steel frame offers a generous platform for the seat to comfortably rest on - a harmonious union of two materials.

ES Panel es una butaca con estructura de pletina o varilla de acero y revestida de cuero o lana. El interior visto -una butaca hueca en lugar de sólida- supone una alternativa ligera al mobiliario pesadamente sobretapizado.

Forma y confort han sido configurados directamente en el asiento a partir de una superficie de cuero o lana cuidadosamente delimitada.

La sección plana de la estructura de acero ofrece una plataforma generosa para el asiento, que descansa confortablemente sobre ella en una armoniosa unión de dos materiales.

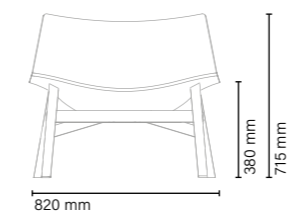





196



197



PANEL collection

Lounge Chair / *Butaca*

**517V**

Lounge chair with metal structure and premium leather seat / *Butaca con estructura metálica de acero y asiento de piel premium*

**517S**

Lounge chair with metal structure and premium waterproof suede leather seat / *Butaca con estructura metálica de acero y asiento de ante resistente al agua premium*

**517F**

Lounge chair with metal structure and felt seat / *Butaca con estructura metálica de acero y asiento de felpa*



POLO collection

Design by Yonoh Studio

EN Polo is a collection of chairs created from flat slats. Its finishes and the way in which its elements are connected allow us to understand the piece in its essence, based on a careful design that gives the result a slight complexity.

The Polo collection is made up of chairs with a beech wood structure, whose seats can be laminated or upholstered. A collection with soul.

ES Polo es una colección de sillas creada a partir de listones planos. Sus acabados y la manera en que están conectados sus elementos permiten comprender la pieza en su esencia, a partir de un diseño cuidado que aporta al resultado una liviana complejidad.

La colección Polo está formada por sillas con estructura de madera de haya, cuyos asientos pueden ser laminados o tapizados. Una colección con alma.

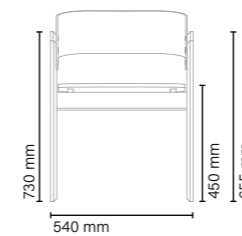





POLO collection

Armchair / Sillón



515M

Armchair with beech wood base and beech plywood backrest / *Sillón con estructura de haya y respaldo de contrachapado de haya*



515T

Semi upholstered armchair with beech wood base and beech plywood backrest / *Sillón semitapizado con estructura de haya y respaldo de contrachapado de haya*



STIR collection

Design by Kazuko Okamoto

EN Light, enveloping and made of laminated beech, the aesthetics of its lines make the Stir an ethereal and clean chair, with a wooden base that draws perfectly symmetrical semicircles on both the feet and the arms.

A collection of chairs and armchairs with solid oak structure. Upholstered seat and back.

ES Ligera, envolvente y hecha de laminado de haya, la estética de sus líneas convierten a Stir en una silla etérea y limpia, con una base de madera que dibuja sendos semicírculos perfectamente simétricos tanto en los pies como en los brazos.

Una colección de sillas y butacas con estructura maciza de roble. Asiento y respaldo tapizados.



reddot award 2016
winner

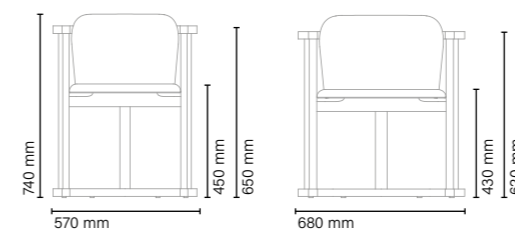



208



209



STIR collection

Armchair / Sillón



380R

Upholstered armchair with oak base /
Sillón tapizado con base de madera de roble

Lounge Chair / Butaca



383R

Upholstered lounge chair with oak base /
Butaca tapizada con base de madera de roble



ULIS collection

Design by Sebastian Herkner

EN The design of the Ulis Lounge adapts to both residential and contract spaces. Sebastian Herkner defines it as his idea of a modern comfort. The soft aesthetic formed to wrap and embrace, guarantees a comfortable and a reclining position at the same time, and make this product space friendly and welcoming.

ES Ulis Lounge se adapta tanto a espacios residenciales como contract. Sebastian Herkner lo define como su idea de confort moderno. Su estética soft, formada para envolver y abrazar, y al mismo tiempo garantizar una posición cómoda y reclinada hacen que este producto convierta los espacios en amables y acogedores.

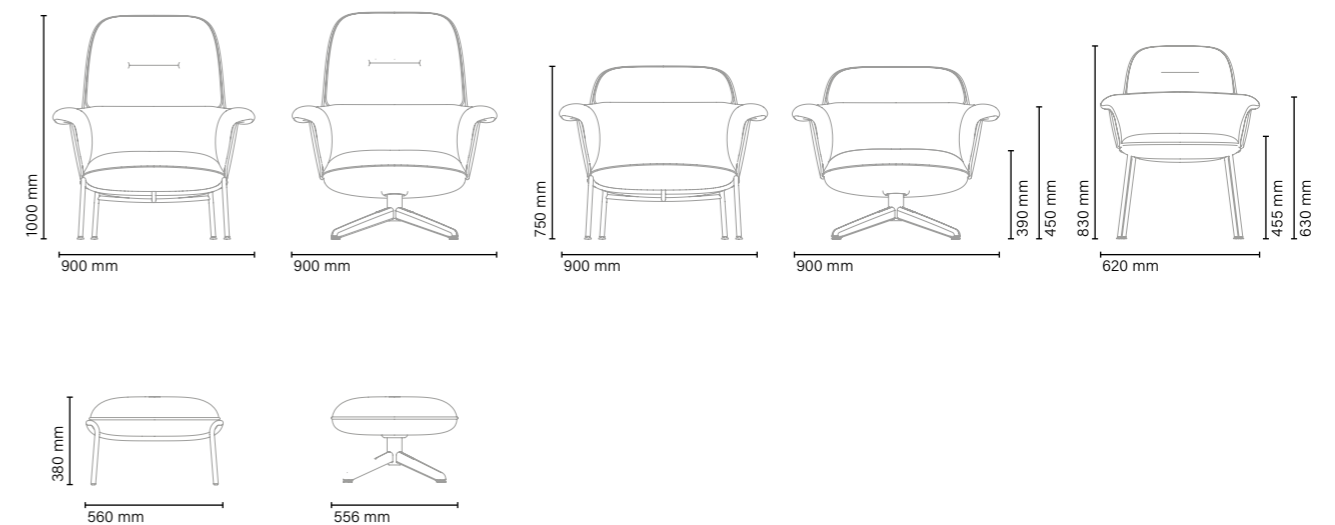



214

215



216



217



ULIS collection

Armchair / Sillón



2155

Upholstered armchair with metal legs /
Sillón tapizado con patas metálicas



2155R

Upholstered armchair with oak wood
frame and metal legs / Sillón tapizado con
carcasa de madera y patas metálicas

Lounge Chair / Butaca



2152

Upholstered lounge chair with low case
and metal base / Butaca tapizada con
carcasa baja y base de metal



2151

Upholstered lounge chair with high case
and metal base / Butaca tapizada con
carcasa alta y base de metal



2152G

Upholstered lounge chair with low case
and wood base / Butaca tapizada con
carcasa baja y base de madera



2151G

Upholstered lounge chair with high case
and wood base / Butaca tapizada con
carcasa alta y base de madera

Footrest / Reposapiés



2158

Upholstered footrest with metal legs /
Reposapiés tapizado con patas metálicas



2158G

Upholstered footrest with oak wood legs /
Reposapiés tapizado con patas de madera
de roble



WEDGE collection

Design by Marcel Sigel

EN Solid wooden structure with seat and chair back in oak plywood. The restback is available in oak wood or upholstered.

The chair features a forward facing cantilevered seat. Although highly visual, its origins have little to do with aesthetics, rather it exists purely as a result of function and rational in the chairs construction.

The starting point for the design was a reflection on the constructive components that define all chairs; a seat, a backrest, and legs. In this case the three elements are visually separated, connected by a single unifying triangle/wedge. Each side of the triangle serves to fix in place one element creating the structure.

ES Wedge es una silla con patas macizas de roble y asiento tapizado. El respaldo está disponible en madera o tapizado.

La silla cuenta con un asiento en voladizo orientado hacia adelante. Aunque resulta muy visual, sus orígenes tienen poco que ver con esta estética, más bien este diseño es el resultado de la función y la racionalidad en la construcción de sillas.

El punto de partida del diseño fue una reflexión sobre los componentes constructivos que definen a todas las sillas; un asiento, un respaldo y las piernas. En este caso, los tres elementos están visualmente separados, conectados por un solo triángulo/cuña unificadora. Cada lado del triángulo sirve para fijar en su lugar un elemento que crea la estructura.

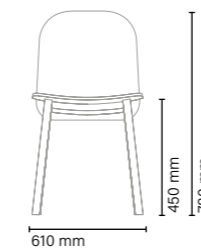

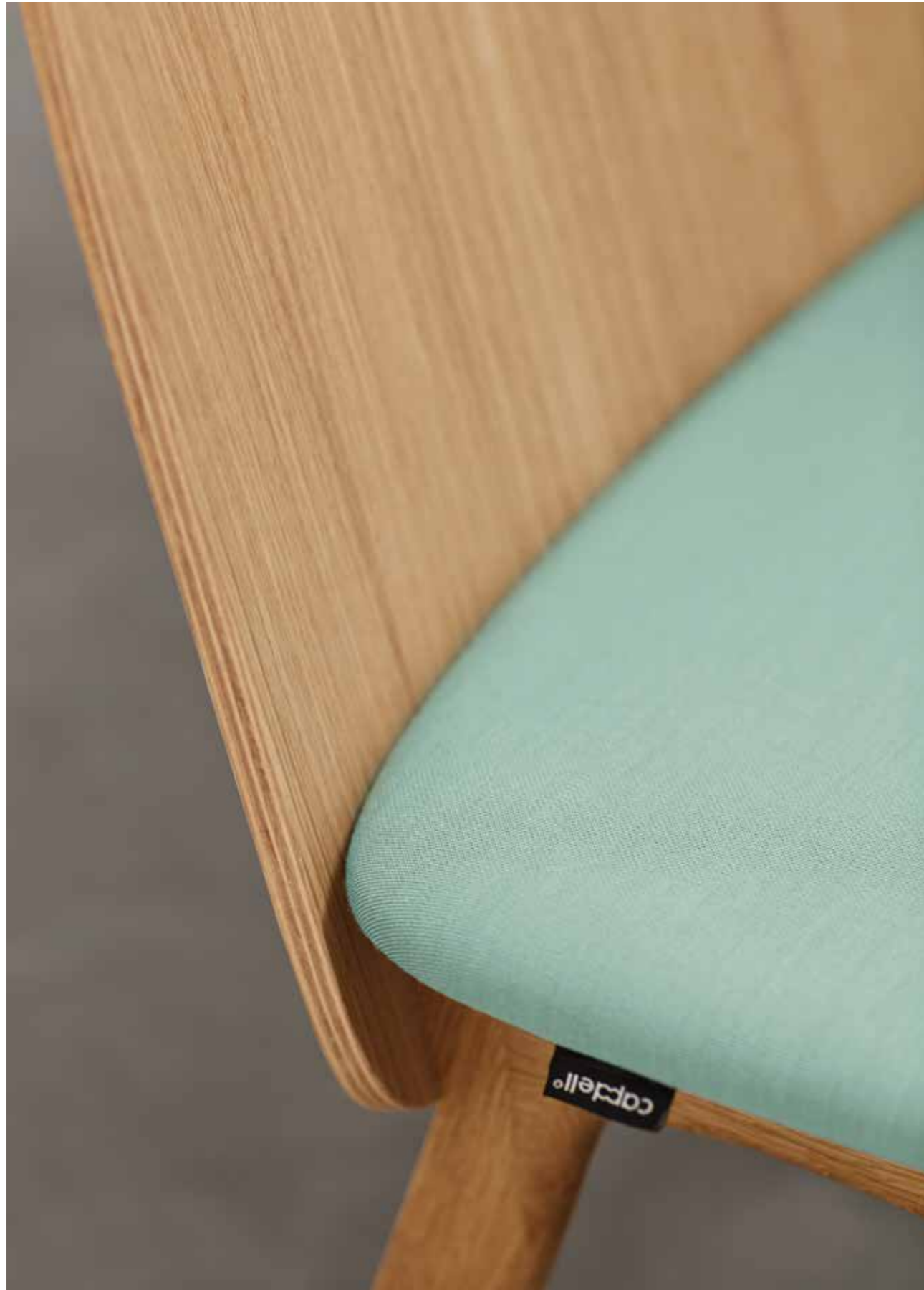

WEDGE collection

Chair / Sillas



360TM

Upholstered chair with base and backrest in oak or beech wood. / Silla tapizada con base y respaldo de madera de roble o haya



360TT

Fully upholstered with base and backrest in oak or beech wood. / Silla tapizada con base y respaldo de madera de roble o haya

SOFAS &
BENCHES /
*SOFÁS Y
BANCOS*



226

ATOLL collection

Design by *Fiorenzo Dorigo*

EN The Atoll collection is a pouf system conceived as a set of independent islands. Its volumes, based on basic geometries, (Triangle, square, pentagon) vary their shape according to the size of the pouf. Surprisingly comfortable, ideal for common areas, workspaces, hotels, homes, and retail spaces.

The finish on their sewings give each piece a unique design.

Atoll is available in four sizes with one, four or five seats with a wide range of fabrics and leather finishings.

Its internal structure of polyurethane foam with a wood base makes the product light and easy to move around.

ES La colección Atoll es un sistema de poufs con volúmenes basados en geometrías básicas (Triangular, cuadrada y pentagonal), varían su forma según el tamaño de pouf. Sorprendentemente cómodos, idóneos para espacios comunes, zonas de trabajo, hoteles, hogar y retail.

El juego de sus formas se refleja en el detalle de las costuras, dándole una personalidad única y especial a cada pieza.

Atoll está disponible en cuatro tamaños de una, cuatro y cinco plazas, con una gama amplia de tapizados en tela o en piel.

Su estructura interior de espuma de poliuretano con base de madera hace que las piezas sean ligeras y fáciles de mover.

227

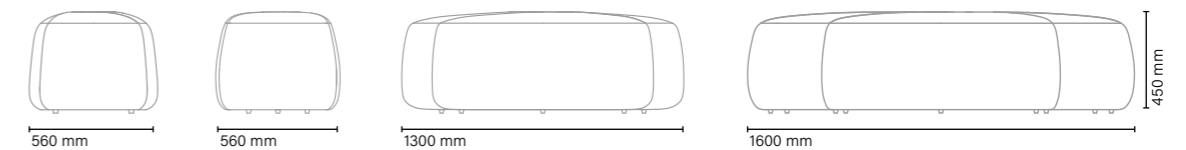



228



229



ATOLL collection

Poufs / Poufs



2011T

One seat pouf with polyurethane foam structure. Triangular shape / Pouf de una plaza con estructura de espuma de poliuretano. Forma triangular



2011C

One seat pouf with polyurethane foam structure. Square shape / Pouf de una plaza con estructura de espuma de poliuretano. Forma cuadrada



2013

Four seat pouf with polyurethane foam structure / Pouf de cuatro plazas con estructura de espuma de poliuretano



2018

Five seat pouf with polyurethane foam structure / Pouf de cinco plazas con estructura de espuma de poliuretano



BOLERO collection

Design by Claesson Koivisto Rune

EN Bolero is a sofa with generous and sinuous shapes that invites you to be welcomed and embraced. The foam seat specially chosen for a comfortable sitting. The backrest is also covered with foams. The entire product is supported on a wooden base with straight lines, which contrast with the sinuosity of the product. Play between the curve, the straight line and the tangency. It is available in several versions: single-seater, two-seater and bench.

ES Bolero es un sofá de formas generosas y sinuosas que invita a la acogida y al abrazo. El asiento de espuma especialmente elegida para una sentada cómoda. El respaldo también está cubierto con espumas. Todo el producto va sustentado sobre una base de madera de líneas rectas, que contrastan con la sinuosidad del producto. Juega entre la curva, la recta y la tangencia. Está disponible en varias versiones: monoplaza, biplaza y bancada.

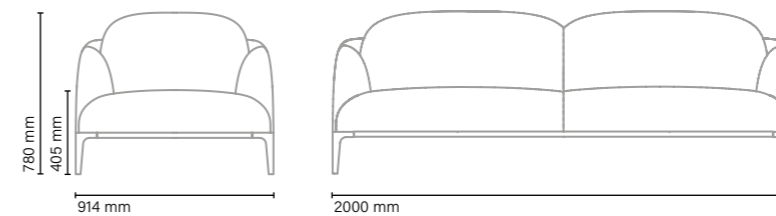



234

235



236

237



BOLERO collection

Sofas / Sofás



2211

Upholstered one seat sofa with beech wood base / Sofá de una plaza tapizado con base de madera de haya



2212

Upholstered sofa with beech wood base / Sofá tapizado con base de madera de haya



BRIDGE collection

Design by Vicente Soto

EN Comfortable and timeless. The tubular steel structure embraces the upholstered seat creating a perfect harmony. With organic shapes and generous extra foam, this collection exudes comfort and visual appeal. Its seductive lines allow it to adapt to countless spaces: common areas, rooms, waiting areas, retail.

Steel base Ø22 mm in powder-coated or chromed finishes and upholstered seat and back.

ES Cómoda y atemporal. La estructura de acero tubular abraza el asiento tapizado creando una armonía perfecta. De formas orgánicas y un generoso extra de espuma, esta colección desprende comodidad y atractivo visual. Sus líneas seductoras le permiten adaptarse a infinidad de espacios: zonas comunes, habitaciones, zonas de espera, retail.

Base tubular de acero de diámetro 22 mm recubierta de pintura en polvo o cromada. Asiento y respaldo totalmente tapizados.

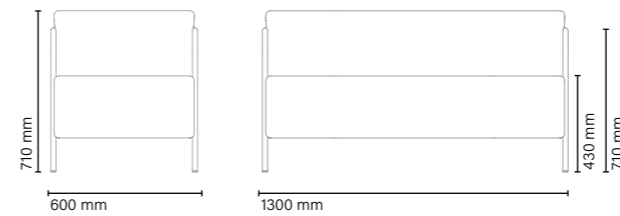



242

243



244



245



BRIDGE collection

Sofas / Sofás

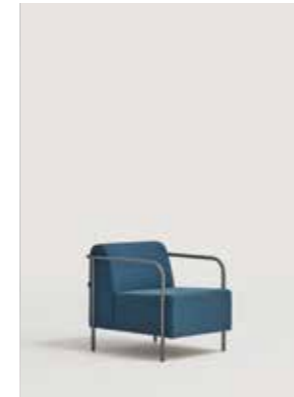

817

Upholstered one seat sofa. Iron frame /
Sofá de una plaza tapizado. Estructura
de acero



817S

Upholstered sofa, steel frame / Sofá
tapizado, estructura acero

DROPLETS collection

Design by Claesson Koivisto Rune

EN Collection of benches and side tables with a light and elegant aesthetic. A minimalist design but with a presence that impacts the environment. The designers, the Claesson Koivisto Rune, were inspired by the shapes that droplets of water make when they land on a surface. The different models allow endless combinations that make this collection a set perfectly adaptable to common spaces, retail and hotels.

The main structure of the collection is birch plywood upholstered with two different foams to make it comfortable. The legs are 16 mm steel tube.

DROPLETS LOW TABLES PAGE 370

ES Colección de bancos y mesas auxiliares de estética liviana y elegante. Un diseño minimalista pero con una presencia que impacta en el entorno. Los diseñadores, los Claesson Koivisto Rune, se inspiraron en las formas que las gotas de agua componen al posarse sobre una superficie. Los distintos modelos permiten infinitas combinaciones que hacen de esta colección un conjunto perfectamente adaptable a espacios comunes, retail y hoteles.

La estructura consta de un tablero de 15 mm de contrachapado de abedul tapizado con dos espumas de diferentes densidades para darle una mayor comodidad. Pies de tubo de hierro reforzado de 16 milímetros.

MESAS DROPLETS PÁGINA 370

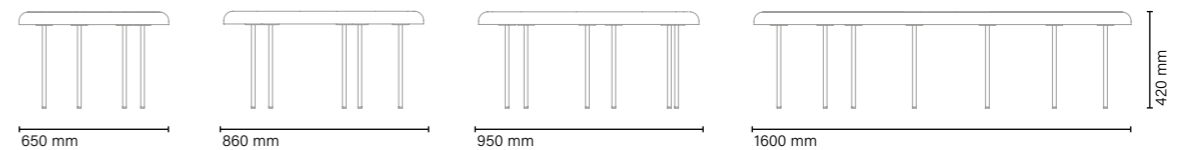



250

251





DROPLETS collection

Bench / Banco



182
Bench upholstered seat with steel legs
/ Banco asiento tapizado con patas
metálicas



183
Bench upholstered seat with steel legs
/ Banco asiento tapizado con patas
metálicas



184
Bench upholstered seat with steel legs
/ Banco asiento tapizado con patas
metálicas



186
Bench upholstered seat with steel legs
/ Banco asiento tapizado con patas
metálicas

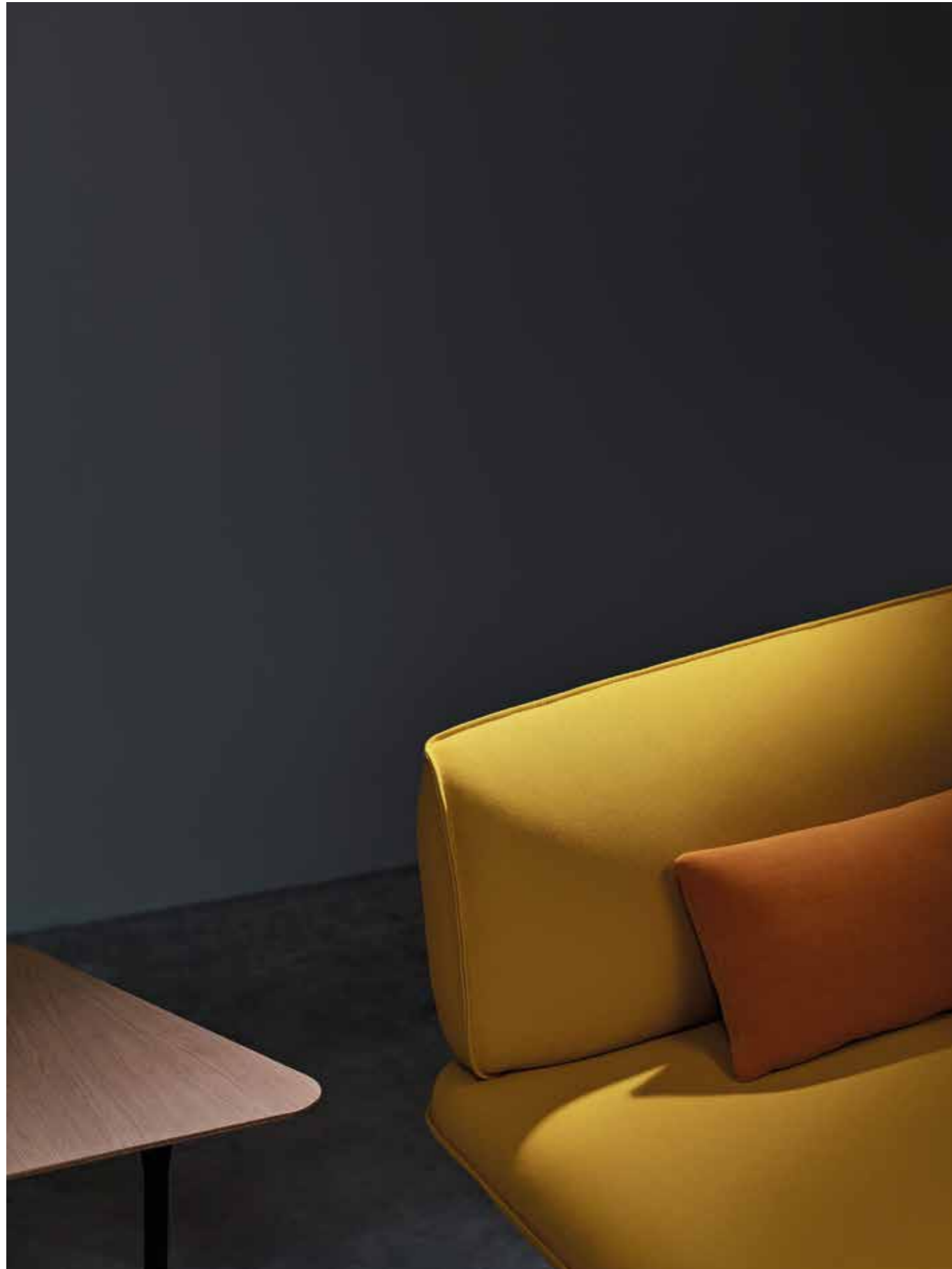

ÍNSULA collection

Design by Patrick Norguet

EN The Ínsula collection is a customizable seating and table system that offers multiple solutions for enhancing shared spaces.

Designed by Patrick Norguet, this collection draws inspiration from the sinuous forms of natural landscapes, which adapt and grow to fit any environment while preserving their primary function: to provide comfort and ease in common areas.

The Ínsula system consists of two seat structures (short seat or long seat) and three backrest options (A, B, and C). These elements can be combined and connected seamlessly, accompanied by tabletop surfaces available in various shapes and materials, creating bespoke solutions tailored to any function.

ÍNSULA LOW TABLES PAGE 376



ES La colección Ínsula es un sistema de asientos y mesas personalizable, que ofrece múltiples soluciones para vestir espacios comunes.

Diseñada por Patrick Norguet, esta colección está inspirada en la sinuosidad de los paisajes naturales, que se adaptan mediante su crecimiento a cualquier entorno, pero manteniendo intacta su principal función: ofrecer confort y comodidad en espacios comunes.

El sistema Ínsula, se compone de dos estructuras (asiento corto o asiento largo) y tres modalidades de respaldos (A, B y C). Estas piezas se combinan y se unen entre sí, con un sobre de mesa que puede adoptar diversas formas y materiales, creando soluciones a medida que cubran cualquier función.

MESITAS ÍNSULA PÁGINA 376

Composiciones / Compositions

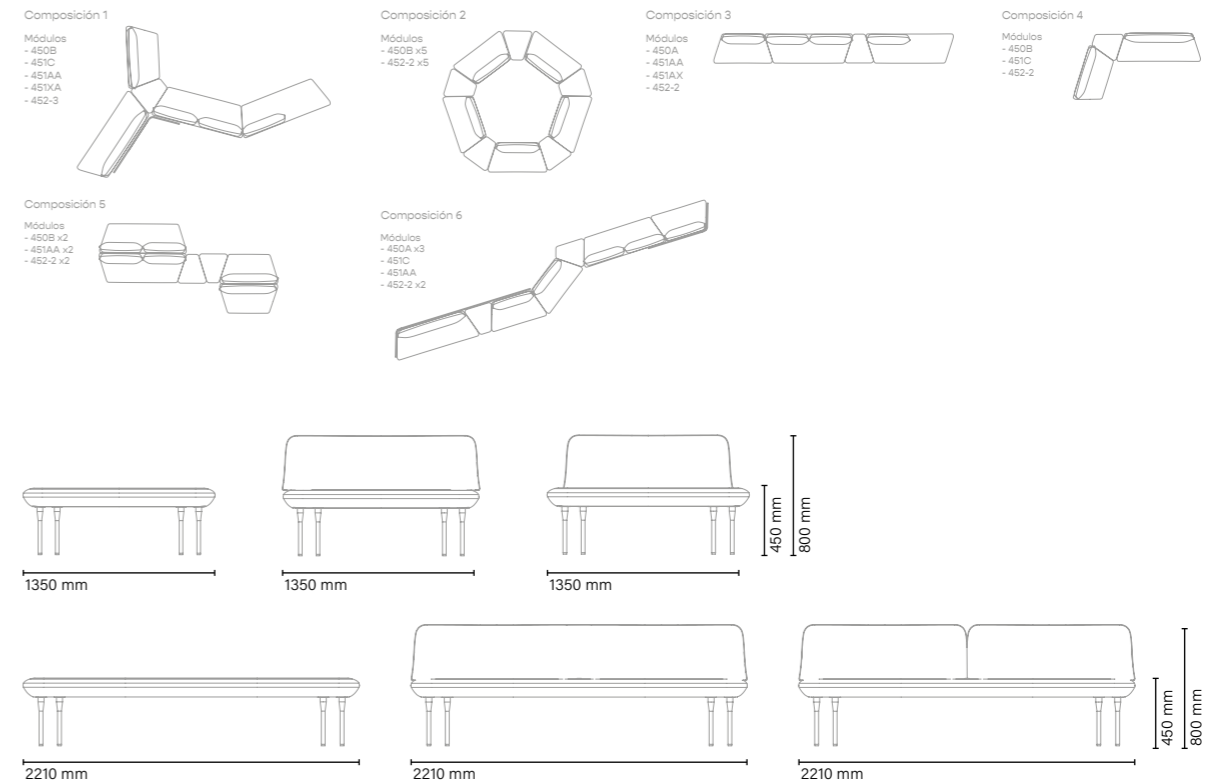





260

261



ÍNSULA collection

Sofas / Sofás

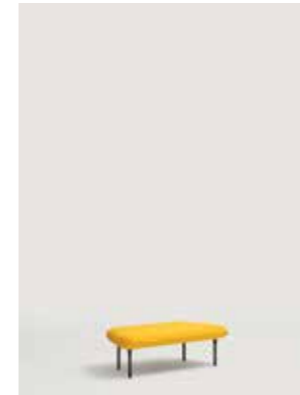

450
Module of short upholstered seat without backrest and metal legs / Módulo asiento largo tapizado sin respaldo y patas metálicas

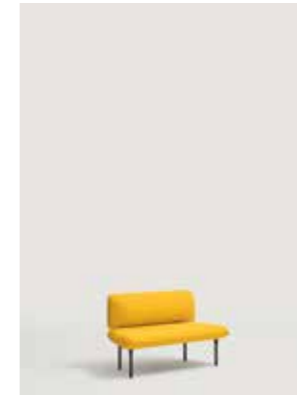

450A
Module of short upholstered seat with one small backrest (A) and metal legs / Módulo asiento corto tapizado con un respaldo pequeño (A) y patas metálicas



450B
Module of short upholstered seat with one medium backrest (B) and metal legs / Módulo asiento corto tapizado con un respaldo mediano (B) y patas metálicas



451
Module of long upholstered seat without backrest and metal legs / Módulo asiento largo tapizado sin respaldo y patas metálicas

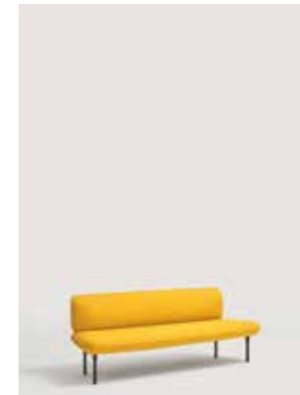

451C
Module of long upholstered seat with one big backrest (C) and metal legs / Módulo asiento largo tapizado con un respaldo grande (C) y patas metálicas

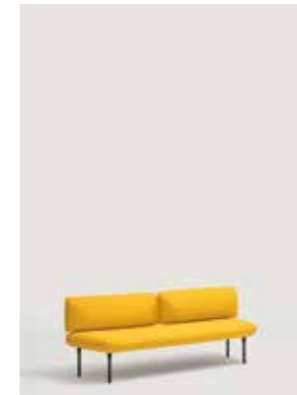

451AA
Module of long upholstered seat with two small backrests (AA) and metal legs / Módulo asiento largo tapizado con dos respaldos pequeños (AA) y patas metálicas



451AX
Module of long upholstered seat with one small backrest (A) and metal legs / Módulo asiento largo tapizado con un respaldo pequeño (A) y metálicas

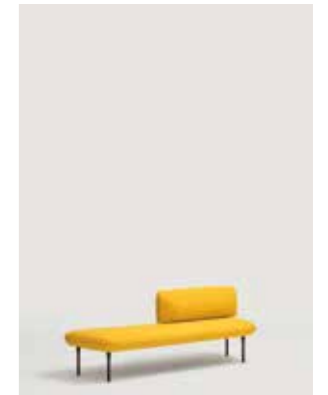

451XA
Module of long upholstered seat with one small backrest (A) and metal legs / Módulo asiento largo tapizado con un respaldo pequeño (A) y metálicas



452
Table connexion / Conexión mesa



NODAL collection

Design by Luca Nichetto

EN Designed by Luca Nichetto, Nodal redefines the approach to space design, offering endless configurations to meet both the functional and aesthetic needs of any project. With its versatility and customizable nature—both in composition and finishes—Nodal effortlessly adapts to any environment.

Nodal is a system of multifunctional sofas and accessories that delivers a fully personalized experience while preserving the elegance and timeless quality of its design.

Starting with basic structures of one, two, or three seats, we integrate modules for armrests, backrests, or tables, creating infinite combinations. Its remarkable versatility allows for configurations that range from classic solutions, such as individual sofas, to more elaborate compositions tailored to each space.

Thanks to its vast design possibilities, Nodal is the perfect solution for large-scale Contract projects. A system that empowers architects and interior designers to create virtually limitless layouts, much like assembling a game of Lego.

Discover more configuration options in our Modular Sofas catalog.

ES Diseñado por Luca Nichetto, Nodal ofrece un nuevo enfoque para diseñar el espacio, ofreciendo infinitas configuraciones para satisfacer las necesidades funcionales y estéticas de cualquier proyecto. Gracias a su versatilidad y personalización, tanto en su composición como en sus acabados, Nodal se adapta sin esfuerzo a cualquier entorno.

Nodal es un sistema de sofás y complementos multifuncionales que ofrece una experiencia de personalización completa, conservando la elegancia y atemporalidad de su diseño.

A partir de estructuras básicas de una, dos o tres plazas, acoplamos módulos de brazos, respaldos o mesas, creando infinitas combinaciones. Su gran versatilidad permite configuraciones que van desde opciones clásicas, como sofás individuales, hasta composiciones más elaboradas adaptadas a cada espacio.

Gracias a sus múltiples posibilidades de diseño, Nodal es la opción ideal para grandes proyectos del sector Contract. Un sistema que da a arquitectos e interioristas la libertad de crear montajes casi sin límites, como si fuera un juego de Lego.

Descubre más opciones de configuración en nuestro catálogo de Sofás Modulares.

Composiciones / Compositions

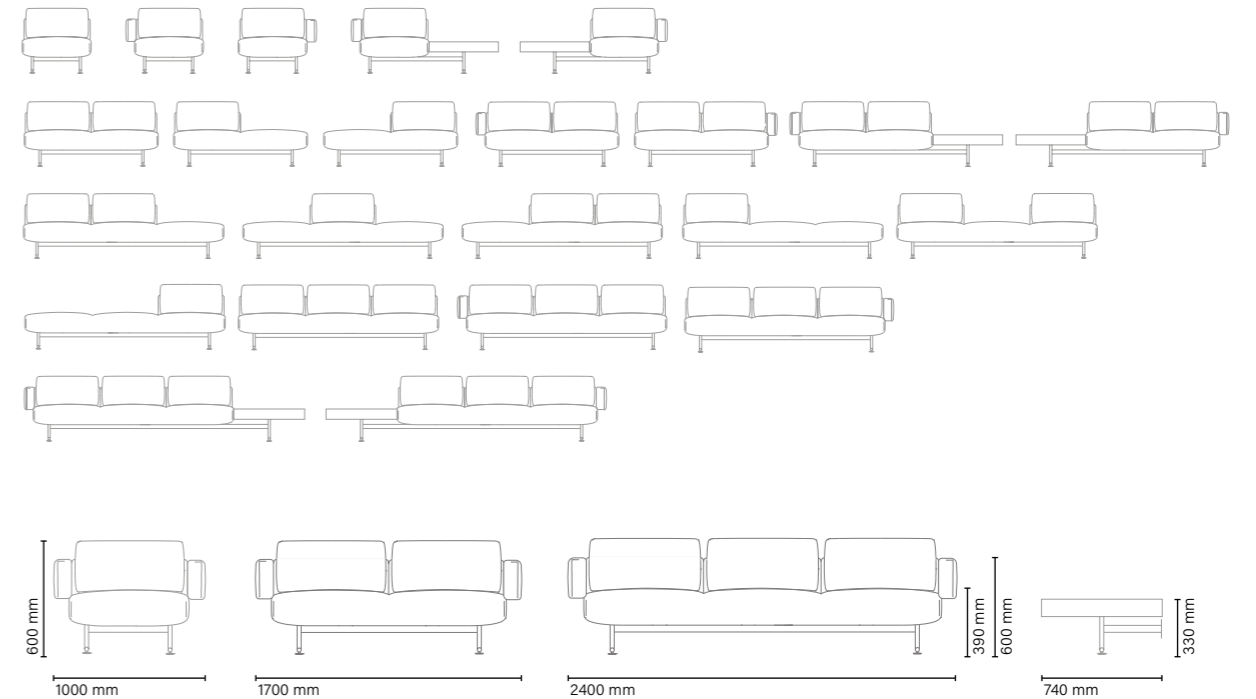



266

267



268



269



270

271



NODAL collection

Sofas / Sofás



2141B
Nodal one seat bench / Bancada Nodal
una plaza



2142B
Nodal two seat bench / Bancada Nodal
dos plazas



2143B
Nodal three seat bench / Bancada Nodal
tres plazas



2140RES
Nodal sofa back / Respaldo sofá Nodal



2140N
Nodal sofa arm / Brazo sofá Nodal

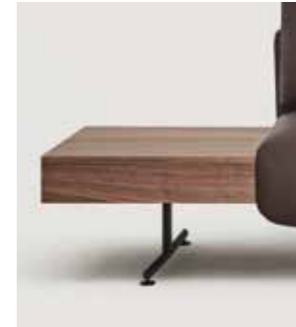

2140T
Nodal sofa table module / Módulo mesa
sofá Nodal

Combinaciones básicas / Basic Options

Nodal es un producto 100% configurable. Combina las distintas piezas para crear tu propio diseño. Infinitas posibilidades.

Nodal is a 100% configurable product. Combine the different pieces to create your own design. Infinite possibilities.



2141
One seat sofa with black powder-coated
metal base. Adjustable metal glides/ Sofá
una plaza con base metálica recubierta de
epoxi negro. Tacos metálicos regulables



2142
Two seat sofa with black powder-coated
metal base. Adjustable metal glides/ Sofá
dos plazas con base metálica recubierta
de epoxi negro. Tacos metálicos regulables



2143
Three seat sofa with black powder-coated
metal base. Adjustable metal glides/ Sofá
tres plazas con base metálica recubierta
de epoxi negro. Tacos metálicos regulables



2140T
Table for all typologies in oak or walnut
wood / Mesa incorporable a todos los
modelos en madera de roble o nogal



PLUM collection

Design by Claesson Koivisto Rune

EN A Plum collection with elegant proportions, it has been carefully designed to be soft and welcoming. As if it were an embrace, the outline and rounded shapes that give the collection its character are not strictly mathematical, but a combination of curves that interlace and invite you to sit on them.

A collection of sofas that works in any space, whether in a hotel lobby or in the living room of a home; that is why a lot of attention has been devoted to sculpting the volume of each piece from all angles, even from the rear.

ES Una colección Plum de proporciones elegantes, ha sido cuidadosamente diseñada para resultar suave y acogedora. Como si se tratara de un abrazo, el perfil y las formas redondeadas que dan a la colección su carácter no son estrictamente matemáticas, sino una combinación de curvas que se enlazan e invitan a sentarse en ellos.

Colección de sofás que funciona en cualquier espacio, ya sea en el lobby de un hotel o en el salón de una vivienda; por eso se ha dedicado mucha atención a esculpir los volúmenes de cada pieza desde todos los ángulos, incluso desde la parte trasera.

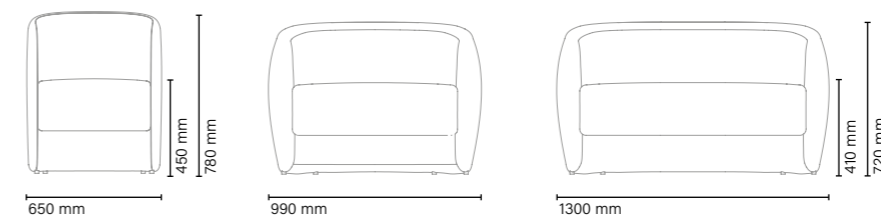

276



277

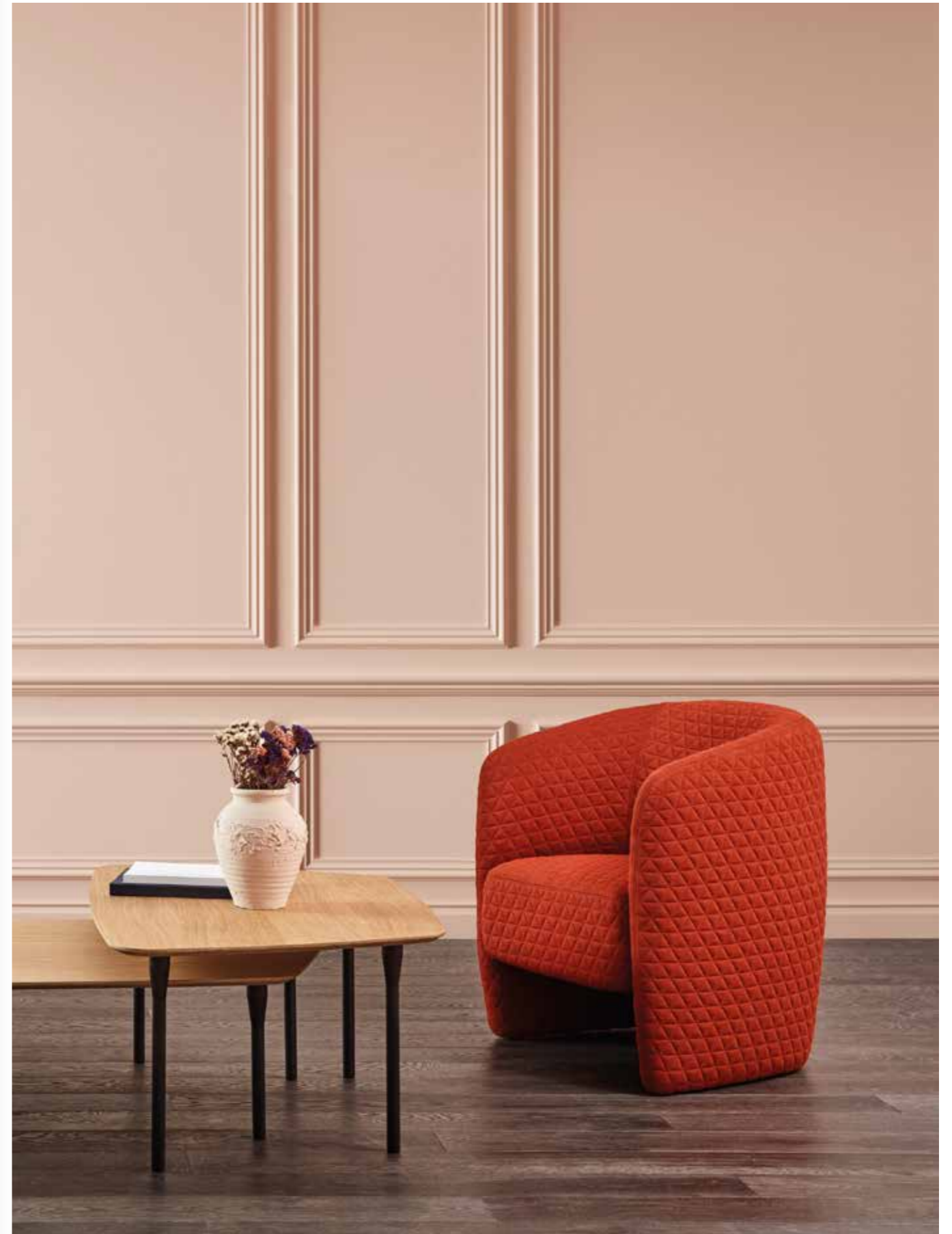



278



279

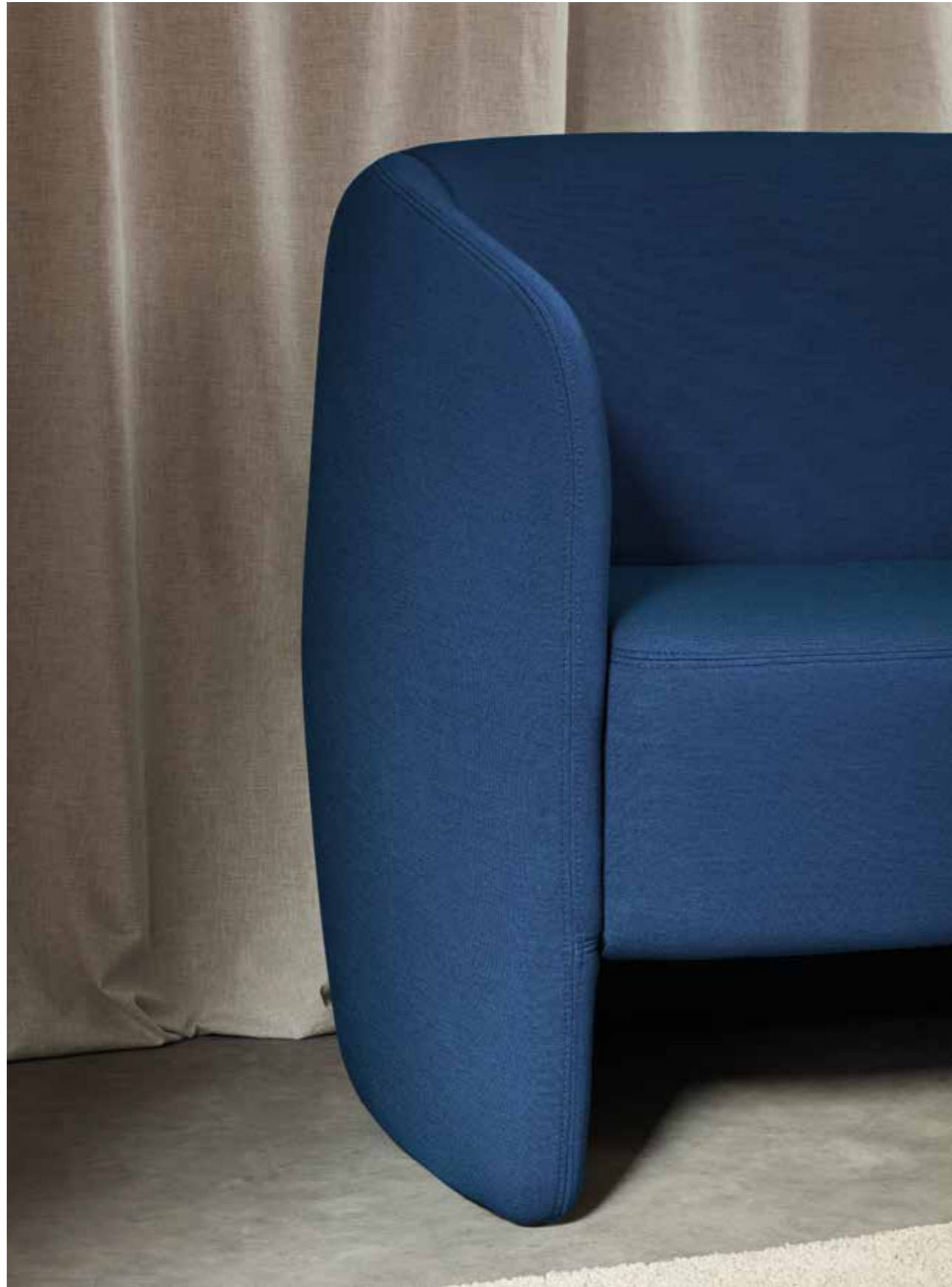

PLUM collection

Sofas / Sofás



560
Upholstered armchair. Optional wheels
(560R) / Butaca tapizada. Ruedas
opcionales (560R)



565
Big size upholstered lounge chair /
Butaca tapizada tamaño grande



560S
Upholstered sofa / Sofá tapizado



VISION collection

Design by Fiorenzo Dorigo

EN Vision, collection of seats for waiting, relaxing or working. The shape of the backrests -high or low- creates reserved areas for intimate and quiet moments or for discreet business meetings. The structures on both sides give Vision personality and a very special look. The seat of the Vision is removable.

ES Vision, colección de asientos para esperar, relajarse o trabajar. La forma de los respaldos -altos o bajos- crea áreas reservadas para momentos íntimos y tranquilos o para discretos encuentros de negocios. Las estructuras en ambos laterales dan a Vision personalidad y un aspecto muy especial. El asiento del Vision es desenfundable.

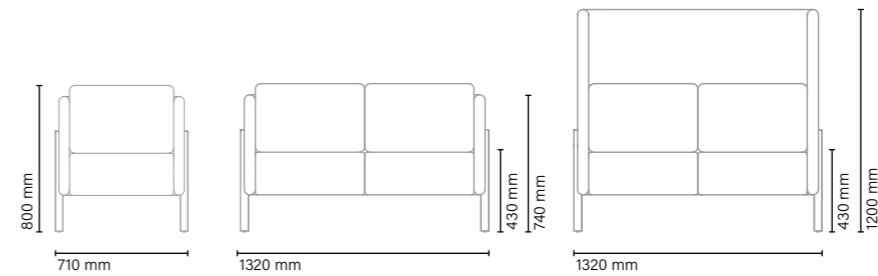



284

285



VISION collection

Sofas / Sofás



570

Upholstered one seat sofa with beech wood legs/ Sofá tapizado de una plaza con pies de madera de haya



570S

Upholstered two seat sofa with beech wood legs/ Sofá tapizado de dos plazas con pies de madera de haya



570SA

Upholstered two seat sofa with beech wood legs. High back/ Sofá tapizado de dos plazas con pies de madera de haya. Respaldo alto

TABLES /
MESAS



290

ABLE collection

Design by Claesson Koivisto Rune

EN Able is a collection of tables focused on the material, the wood, with a 'natural' finish as if it had just come from the sawmill, contrasted with the structural bars of the frame and visible details that make up the table's skeleton. The proportions play with the stylistic dichotomy between the solid structure of the slightly slanted legs in solid oak and the elegant table top that renders the whole streamlined and aerodynamic. Various types and sizes are available.

ES Able es una colección de mesas centrada en el material, la madera, con un acabado "natural" como si acabara de salir del aserradero, contrastando con las barras estructurales y los detalles visibles que conforman el esqueleto de la mesa. Las proporciones juegan con la dicotomía estilística entre la sólida estructura de las patas ligeramente inclinadas de roble macizo y el elegante tablero que hace que el conjunto sea elegante y aerodinámico. Hay diferentes tipos y tamaños disponibles.

291

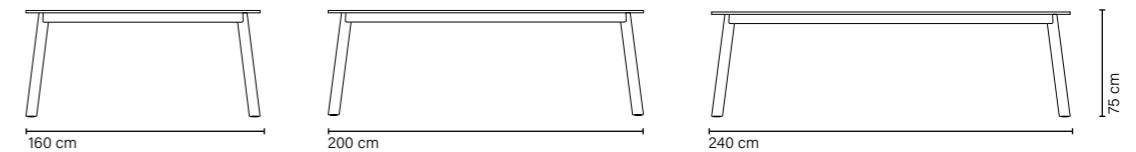





ABLE collection

Table / Mesa



TA160 / TA200 / TA240

Table with steel structure, solid oak legs
and oak veneer top / Mesa con estructura
de metal, patas de madera maciza de roble
y tapa chapada en madera de roble



296

ATRIA collection

Design by Gabriel Teixidó

EN Atria is a collection of seats that includes chairs, armchairs, lounge chairs and a table. Its soft and light shapes emanate the warmth of the materials: solid oak and premium leather.

Atria table comes with a solid oak wood structure. The top with an oak veneer finish. Available in 3 sizes: 200 x 100, 240 x 100, and 300 x 100 cm.

Its name refers to the atrium of Roman houses, around which the social life of the house revolved. It also means the brightest star.

ES Atria es una colección de asientos, compuesta por silla, silla con brazos, butaca y mesa. Sus formas suaves y ligeras emanan la calidez de los materiales: el roble macizo y cuero.

La mesa Atria está hecha con estructura de madera de Roble maciza. La tapa con acabado chapado en roble. Disponible en 3 tamaños: 200 x 100, 240 x 100 y 300 x 100 cm.

Su nombre hace referencia al atrio de las vivienda romanas, en torno al cual giraba la vida social de la casa. También significa la estrella que más brilla.

297

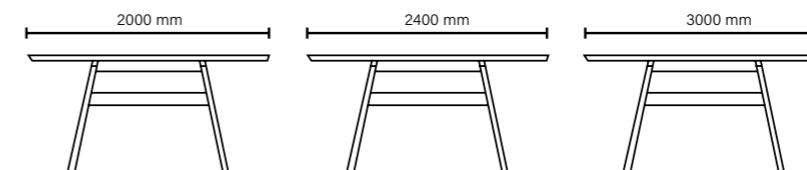



ATRIA collection

Table / Mesa



TAT20 / TAT24 / TAT30

Oak table with oak plywood top / Mesa de roble con tapa chapada en roble



BASIC TABLES collection

Design by Capdell

EN Basic is a collection of tables with steel base covered with epoxy paint. The base and top are available in round or square shape. Its simple and bold design and its customization ability make it the perfect complement for any type of projects, contract or residential. Available in two heights 75 and 110cm.

ES Basic tables colección de mesas con base de acero recubierto de pintura epoxi. La base y el sobre están disponibles en redondo o cuadrado. Su diseño simple y audaz y su capacidad de personalización hacen que sea el complemento perfecto para cualquier tipo de proyecto, contract o residencial. Disponible en dos alturas 75 y 110cm.

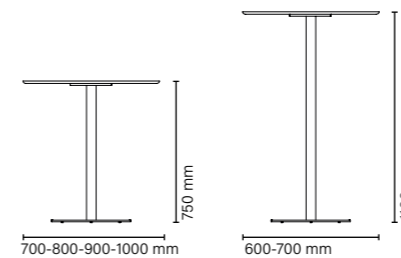



302



303



BASIC TABLES collection

Table / Mesa



TB74-O60
TB74-O70
TB74-O80
TB74-O90

Round steel base with powder-coated finishing / Base redonda de acero con recubrimiento de pintura en polvo.



TB110-O60
TB110-O70

High round steel base with powder-coated finishing / Base alta redonda de acero con recubrimiento de pintura en polvo.



TB74-6060
TB74-7070
TB74-8080
TB74-9090

Square steel base with powder-coated finishing / Base cuadrada de acero con recubrimiento de pintura en polvo.



TB110-6060
TB110-7070

High square steel base with powder-coated finishing / Base alta cuadrada de acero con recubrimiento de pintura en polvo.



306

GUS collection

Design by Francesc Rifé

EN Collection of tables with a sober but at the same time balanced design. The feature that stands out most in Gus is, without a doubt, the revolutionary concrete base, which aims to merge with the urban landscape, transforming itself into an extension of the pavement. Both because of its strong personality and its ability to personalize, it is a table that can dress up any type of space.

ES Colección de mesas con un diseño sobrio pero al mismo tiempo equilibrado. El rasgo que más destaca en Gus es, sin lugar a dudas, la revolucionaria base de hormigón, que pretende fundirse con el paisaje urbano transformándose en una extensión del pavimento. Tanto por su fuerte personalidad como por su capacidad de personalización es una mesa que puede vestir cualquier tipo de espacio.

307

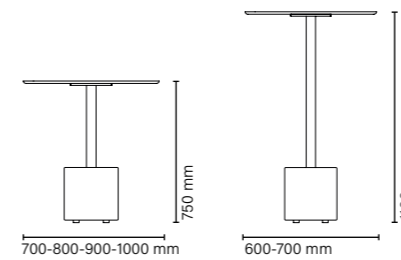



308



309



310



311



GUS collection

Table / Mesa



TG74-O60
TG74-O70
TG74-O80
TG74-O90

Table 74 cm with concret and steel base.
Round top / Base 74 cm de cemento y
acero con recubrimiento de pintura en
polvo. Tapa redonda

Available / Disponible en:
Ø 60 / 70 / 80 / 90 cm



TG110-O60
TG110-O70

Table 110 cm with concret and steel base.
Round top / Base 100 cm de cemento y
acero con recubrimiento de pintura en
polvo. Tapa redonda

Available / Disponible en:
Ø 60 / 70 cm



TG74-6060
TG74-7070
TG74-8080
TGU4-9090

Table 74 cm with concret and steel base.
Square top / Base 74 cm de cemento y
acero con recubrimiento de pintura en
polvo. Tapa cuadrada

Available / Disponible en:
60x60 / 70x70 / 80x80 / 90x90 cm



TG110-6060
TG110-7070

Table 110 cm with concret and steel base.
Square top / Base 110 cm de cemento y
acero con recubrimiento de pintura en
polvo. Tapa cuadrada

Available / Disponible en:
60x60 / 70x70 cm



GAZELLE collection

Design by Claesson Koivisto Rune

EN Light, ethereal and very chic. A collection of tables with a pure and stylized design. The main characteristic of this collection is the subtle but sculptural morphology of the elegant legs, its design, made of anodized aluminum, is the result of a digital, fluid and gradual morphing of the transformation between a circle and a triangle. An exercise in refined elegance that eliminates mass and leaves only the essentials.

Available in various sizes, shapes and materials. The legs can be finished in polished anodized aluminum or epoxy paint.

ES Ligera, etérea y muy chic. Una colección de mesas con un diseño puro y estilizado. La principal característica de esta colección es la sutil pero escultural morfología de las elegantes patas, su diseño, hecho en aluminio anodizado, es el resultado de un morphing digital, fluido y gradual de la transformación entre un círculo y un triángulo. Un ejercicio de refinada elegancia que elimina masa y deja solamente lo esencial.

Disponible en varios tamaños, formas y materiales. El acabado de las patas puede ser en aluminio anodizado pulido o pintura epoxi.

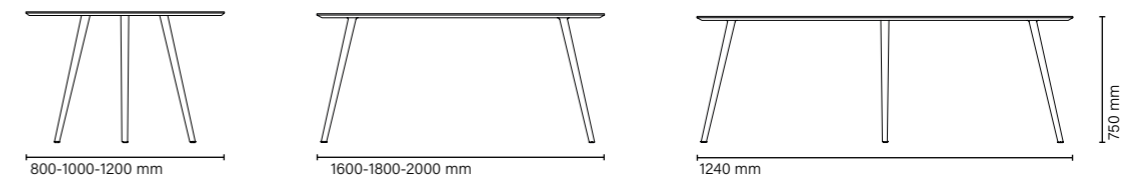



316

317



Image courtesy of Arkoslight / Imagen cortesía de Arkoslight

GAZELLE collection

Table / Mesa



TG-80 / TG-80P
TG-100 / TG-100P
TG-120 / TG-120P

Aluminium legs are available in polished or powder coated. Round top / Patas de aluminio disponibles en pulido o recubrimiento en polvo. Tapa redonda



TG-1610 / TG-1610P
TG-1810 / TG-1810P
TG-2010 / TG-2010P

Aluminium legs are available in polished or powder coated. Oval top / Patas de aluminio disponibles en pulido o recubrimiento en polvo. Tapa oval



TG-2412 / TG-2412P

Aluminium legs are available in polished or powder coated. Oval top / Patas de aluminio disponibles en pulido o recubrimiento en polvo. Tapa oval



LIBRIS collection

Design by Vicent Martínez

EN The Libris table collection is inspired by books and how their leaves are made. This table is available in an extendable version and as a modular system to create wide compositions. The covers of the Libris extendable have a flexible and very resistant carbon fiber joint. The movement, turning and unfolding are inspired by the old Dutch gaming tables. The Libris system can be customized with a central channel with hinged covers that give easy access to the table's wiring and leave all the wiring hidden. This modular system allows the tables to be configured and dimensioned to equip all types of spaces, facilities, hotels, offices or residential places. Capdell's tradition, culture and taste for cabinetmaking are reflected in the curved and laminated arched wood that, together with the solid wood benches, support the laminated board tops.

ES La colección de mesas Libris se inspira en los libros y en cómo se conforman sus hojas. Esta mesa está en versión extensible y como sistema modular para crear amplias composiciones. Las tapas de la Libris extensible tienen una unión de fibra de carbono flexible y muy resistente. El movimiento, giro y desplegado se inspiran en las antiguas mesas de juego holandesas. El sistema Libris puede personalizarse con un canal central de tapas abatibles que dan fácil acceso al electrificado de la mesa y dejan todo el cableado oculto. Este sistema modular permite configurar y dimensionar mesas para equipar todo tipo de espacios, instalaciones, hostelería, oficinas o lugares residenciales. La tradición, cultura y gusto por la ebanistería de Capdell se reflejan en los arcos de madera curvada y laminada que junto a las bancadas de madera maciza dan soporte a las tapas de tablero laminado.

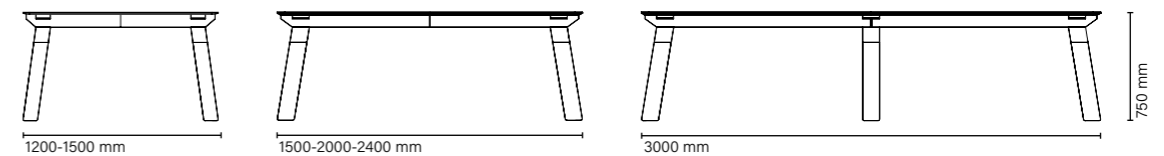



322

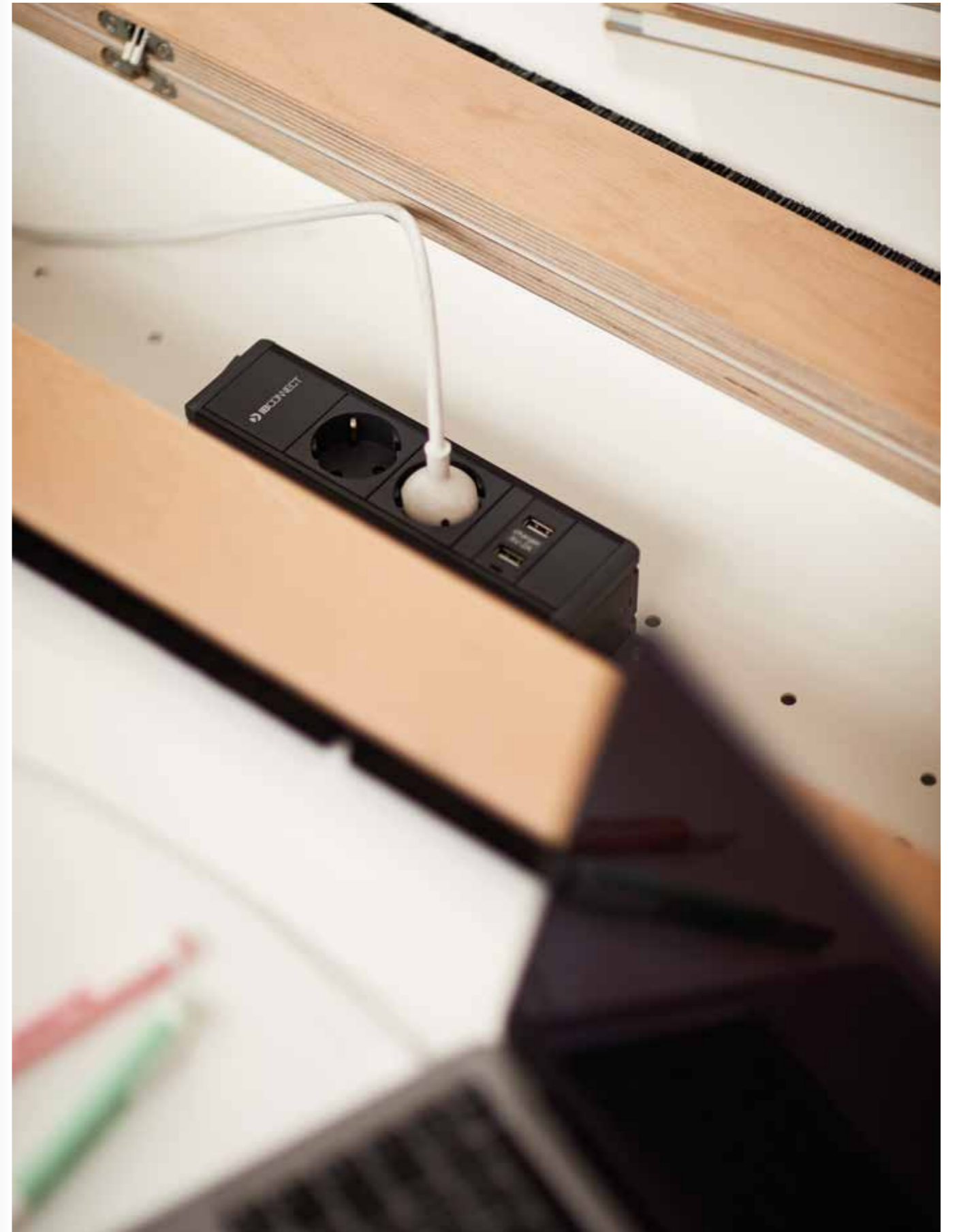

323



324

325



326

327



328



329



LIBRIS collection

Table / Mesa



TLEX-12090
TLEX-15090

Extensible table with oak or beech legs and structure. Top available in diferent finishes / Mesa extensible con patas y estructura de haya o roble. Tapa disponible en varios acabados



TL-150100
TL-200100
TL-240100
TL-300100

Table with oak or beech legs and structure. Top available in diferent finishes / Mesa con patas y estructura de haya o roble. Tapa disponible en varios acabados



TLE-150120
TLE-200120
TLE-240120
TLE-300120

Electrified table with oak or beech legs and structure. Top available in diferent finishes / Mesa Electrificada con patas y estructura de haya o roble. Tapa disponible en varios acabados



TLO-120
TLO-140

Round table with oak or beech legs and structure. Top available in diferent finishes / Mesa redonda con patas y estructura de haya o roble. Tapa disponible en varios acabados



NOOK collection

Design by Mario Ruiz

EN Table collection available with a central base or a rod base, both offered in two heights.

The metal rod table, like the Nara stool, has a distinctly symmetrical character and plays with the tangency of the rod.

The tabletop is modular, consisting of two pieces.

ES Colección de mesas, disponible en pie central y en varilla, ambas en 2 alturas.

La mesa de varilla metálica, al igual que el taburete Nara, tiene un marcado carácter simétrico, y juega con la tangencia de la varilla.

El top de la mesa es modular, formado por dos piezas.

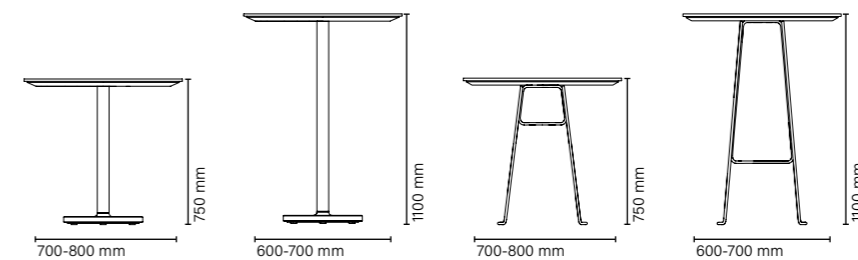



334



335



336



337



NOOK collection

Table / Mesa



TNC74-O70
TNC74-O80

Table with concret and steel base.
Modular top, it is made up of two pieces /
Mesa con base de cemento y acero. Tapa
formada por dos piezas

Available / Disponible en:
Altura: 74 cm
Ø entre 70 y 80 cm



TNC110-O60
TNC110-O70

Hight table with concret and steel base.
Modular top, it is made up of two pieces
/ Mesa alta con base de cemento y acero.
Tapa formada por dos piezas

Available / Disponible en:
Altura: 110 cm
Ø entre 60 y 70 cm



TNV74-O70
TNV74-O80

Table with metal rod base. Modular top,
it is made up of two pieces / Mesa con
base de varilla de acero. Tapa formada por
dos piezas

Available / Disponible en:
Altura: 74 cm
Ø entre 70 y 80 cm



TNV110-O60
TNV110-O70

Hight table with metal rod base. Modular
top, it is made up of two pieces / Mesa
alta con base de varilla de acero. Tapa
formada por dos piezas

Available / Disponible en:
Altura: 110 cm
Ø entre 60 y 70 cm



340

MESANA collection

Design by Salvador Villalba

EN A flexible and modular collection of tables, with its own personality, made up of two solid beech trestle and a HDF top. Its simplicity and versatility make it fit in any space, wheter residential, contract or corporate.

The detail of the insertion of the leg in the tabletop gives a distinctive touch to the collection while serving as a fixing for the tabletop, allowing it to be easily handled for assembly and disassembly without requiring the use of tools.

ES Colección de mesas flexible y modular, con una personalidad propia, compuesta por dos caballetes de madera maciza de haya y sobre de HDF. Su sencillez y polivalencia hacen que encaje en cualquier espacio ya sea residencial, contract o corporativo.

El detalle de la inserción de la pata en el tablero concede un toque distintivo a la colección a la vez que sirve de fijación para el tablero permitiendo su fácil manipulación para montaje y desmontaje sin requerir el empleo de herramientas.

341

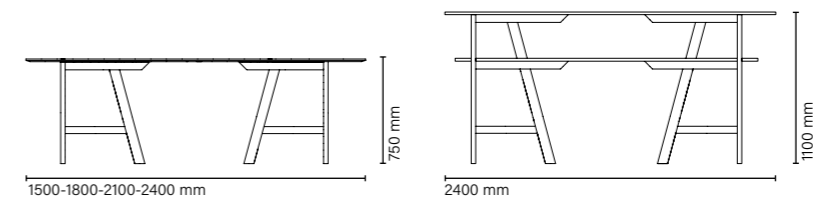



342



343



MESANA collection

Table / Mesa



**TM74-150 / TM74-180
TM74-210 / TM74-240**

Table with beech wood bases and HDF top / Mesa con patas de haya y tapa de HDF



TM110-240

Hight table with beech wood bases and HDF top / Mesa alta con patas de haya y tapa de HDF



MESANA DESK collection

Design by Patrick Norguet

EN On the basis of the MESANA collection, Patrick Norguet has developed a brand new small office desk for the residential market. A singular compact desk made in oak and available in different colours.

ES Partiendo de nuestra colección MESANA, Patrick Norguet ha desarrollado un escritorio para el hogar. Se trata de un escritorio compacto y de roble, disponible en varios colores.

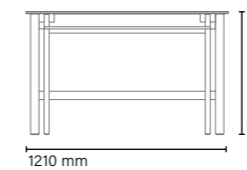



348



349



350

MESANA DESK collection

Table / Mesa



TMD74

Desk with oak wood structure and top /
Escritorio con estructura y tapa de roble

351



352

TRISTAR collection

Design by Claesson Koivisto Rune

EN The Tristar table features a distinctive central foot made from three aluminum extrusions that form a 3-point star-shaped base. This collection has a high customization capacity. Its central column can be veneered in oak or painted in epoxy.

The structure supports tops of various sizes that make Tristar a useful collection for both home and contract. Available in two heights 75 and 55 cm.

ES La mesa Tristar presenta un peculiar pie central hecho de tres extrusiones de aluminio que conforman una base en forma estrellada de 3 puntas. Esta colección tiene una alta capacidad de personalización. Su columna central puede ir chapada en roble o pintada en epoxi.

La estructura soporta sobres de diversos tamaños que convierten a Tristar en una colección útil tanto para hogar como para contract. Disponible en dos alturas 75 y 55 cm.



353

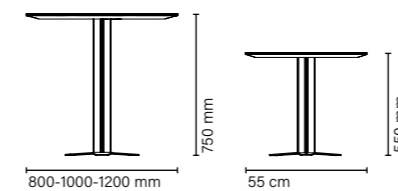



354



355



TRISTAR collection

Table / Mesa



TT74-80 / TT74-80R
TT74-100 / TT74-100R
TT74-120 / TT74-120R

Table with aluminium column, covered
 with laminated oak or epoxy painted
 / Mesa con una columna de aluminio
 chapada en roble o pintura epoxi

Available / Disponible en:
 Altura: 74 cm
 Ø 60 cm



TT55-60 / TT55-60R

Table with aluminium column, covered
 with laminated oak or epoxy painted
 / Mesa con una columna de aluminio
 chapada en roble o pintura epoxi

Available / Disponible en:
 Altura: 55 cm
 Ø 80, 100 y 120 cm



W collection

Design by Gabriel Teixidó

EN W is a table with a striking 50mm diameter steel tube structure in epoxy paint and an extra-clear tempered glass top, a top that makes it an almost invisible part of the piece. Making the W a contemporary table both in terms of its shapes and its combination of materials. The main detail of this table are the V-shaped legs and the intersection that forms between them and the beams that support the top.

ES W es una mesa con una llamativa estructura de tubo de acero de 50mm de diámetro pintura epoxi y sobre de cristal extraclaro templado, un sobre que convierte en una parte casi invisible de la pieza. Haciendo de W una mesa contemporánea tanto por sus formas como por su combinación de materiales. El principal detalle de esta mesa son sus patas en V y la intersección que se forma entre las mismas y las vigas que soportan el sobre.

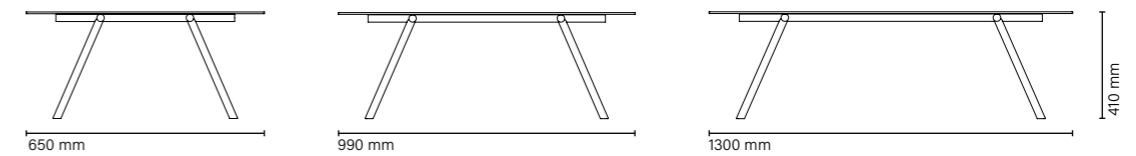



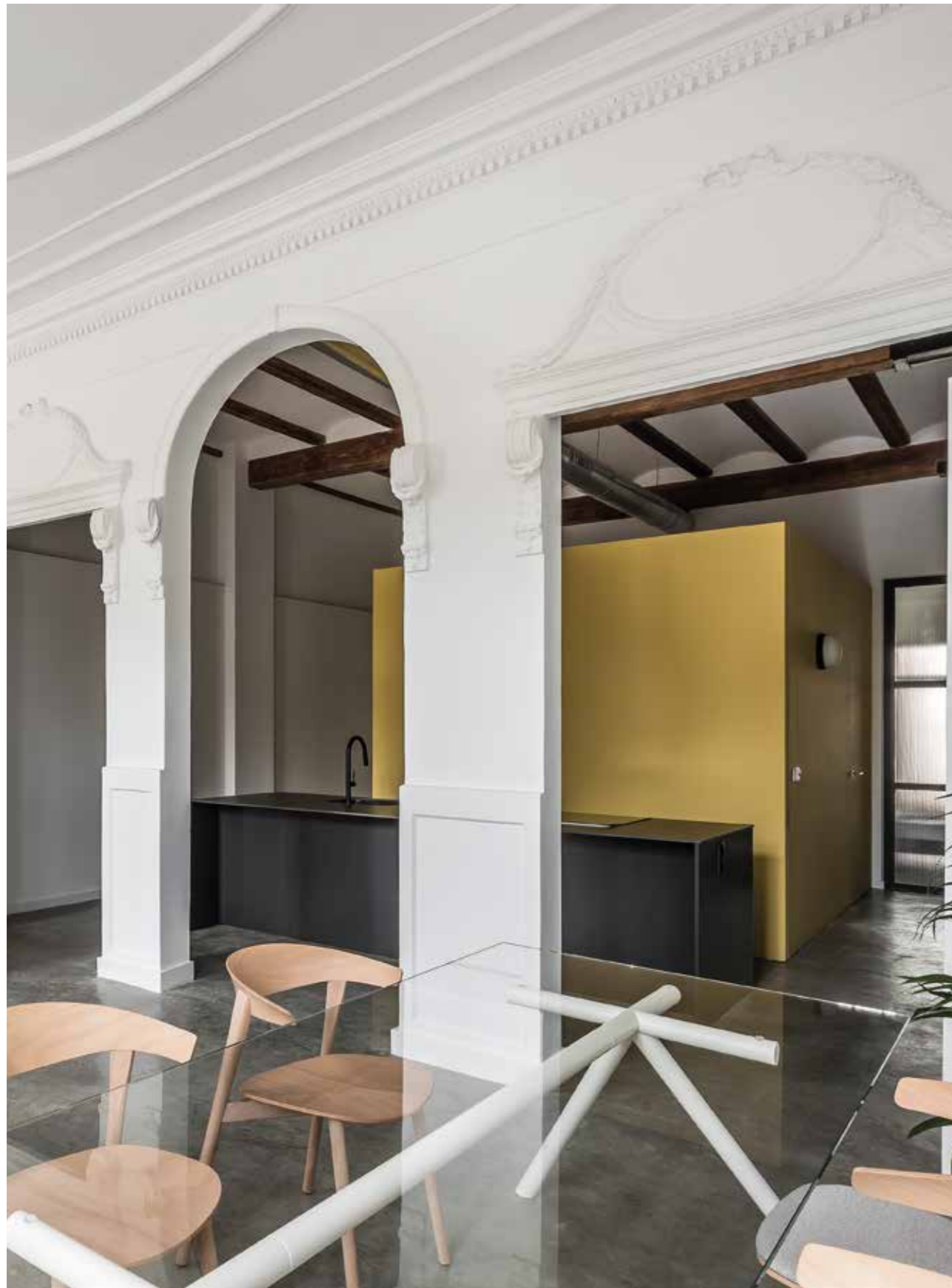

W collection

Table / Mesa



TW16 / TW20 / TW24

Table with base of steel pipe covered by epoxy Top of tempered glass. / Mesa con estructura de acero recubierto de pintura epoxi. Tapa de cristal templado

Available / Disponible en:

Altura: 74 cm
160 x 100 / 200 x 100 / 240 x 100



364

ARO collection

Design by Carlos Tiscar

EN Aro is a collection with a timeless, comfortable and enveloping design, which reinterprets the round seat typology, referring to traditional cabinetmaking.

With the common denominator of the circle through which various elements such as chairs, armchairs, stools and side tables are achieved.

The warmth of the wood and its upholstered versions make it a perfect option for a wide variety of spaces in hotels, restaurants, work environments, home.

Made with PEFC sustainable wood, it can be recycled promoting the circular economy.

ES Aro es una colección con un diseño atemporal, cómoda y envolvente, que reinterpreta la tipología de asiento redondo, evocando a la ebanistería tradicional.

Con el círculo como denominador común de la colección se consiguen diversos elementos como sillas, butacas, taburetes y mesitas auxiliares.

La calidez de la madera y sus versiones tapizadas, la convierten en una opción perfecta para gran variedad de espacios en hoteles, restaurantes, entornos de trabajo y hogar.

Fabricada con maderas sostenibles PEFC, esta puede ser reciclada fomentando la economía circular.

365

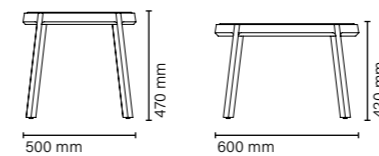

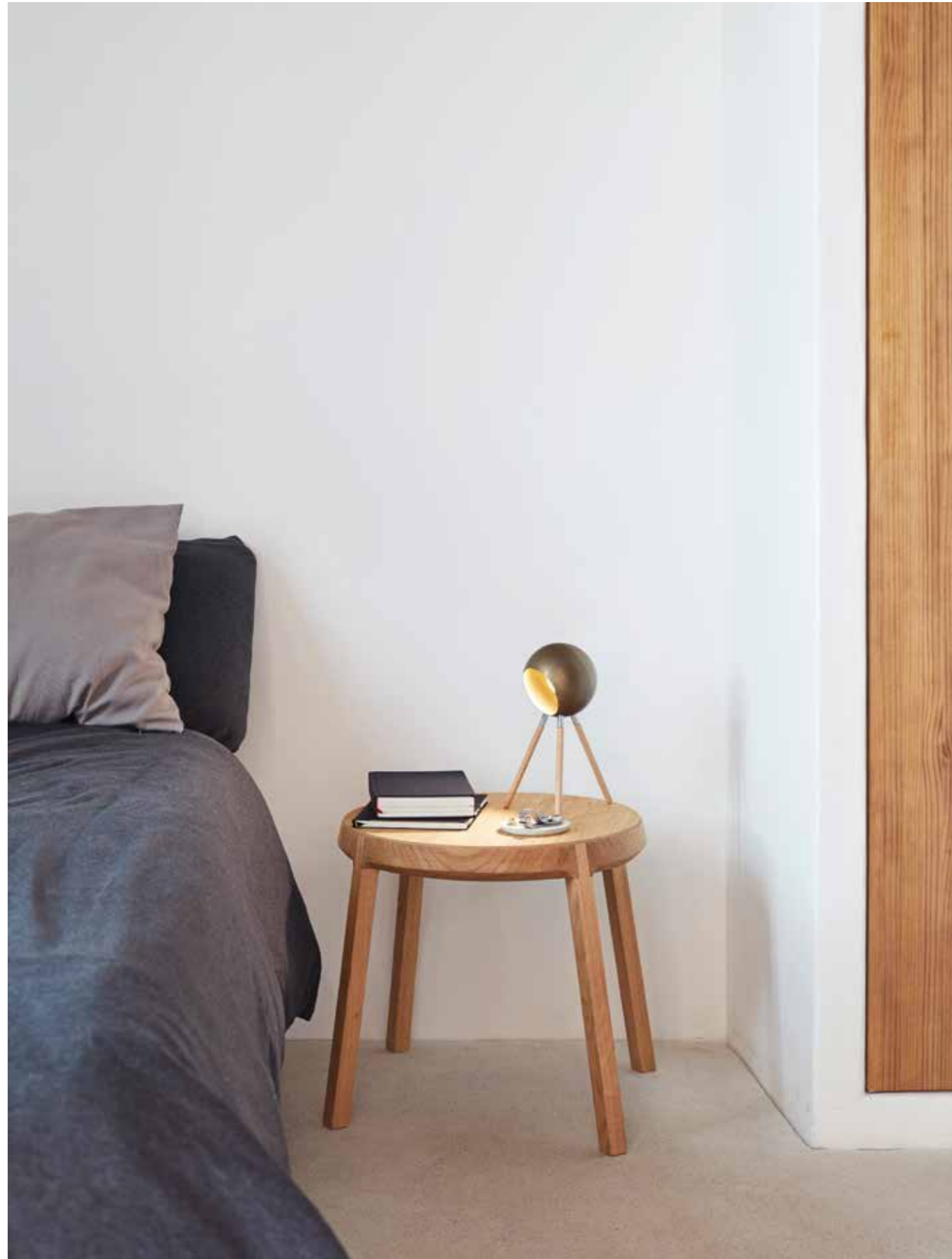

366



367



368

ARO collection

Table / Mesa

**690M / 690RM**

Coffee table with base and top of oak or beech veneer top. / Mesa de café con patas y tapa de madera de roble o haya

Available / Disponible en:
 Altura: 47 cm
 Ø 50 cm

**694M / 694RM**

Coffee table with base and top of oak or beech veneer top. / Mesa de café con patas y tapa de madera de roble o haya

Available / Disponible en:
 Altura: 42 cm
 Ø 60 cm

369



370

DROPLETS collection

Design by Claesson Koivisto Rune

EN Collection of benches and side tables with a light and elegant aesthetic. A minimalist design but with a presence that impacts the environment. The designers, the Claesson Koivisto Rune, were inspired by the shapes that droplets of water make when they land on a surface. The different models allow endless combinations that make this collection a set perfectly adaptable to common spaces, retail and hotels.

ES Colección de bancos y mesas auxiliares de estética liviana y elegante. Un diseño minimalista pero con una presencia que impacta en el entorno. Los diseñadores, los Claesson Koivisto Rune, se inspiraron en las formas que las gotas de agua componen al posarse sobre una superficie. Los distintos modelos permiten infinitas combinaciones que hacen de esta colección un conjunto perfectamente adaptable a espacios comunes, retail y hoteles.

371

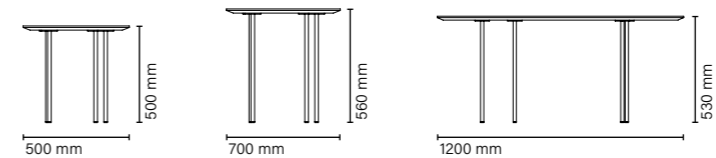



372

373



DROPLETS collection

Table / Mesa



1801Y

Table with metal legs with chrome finish or epoxy paint and beech veneer top. /
Mesa con patas de metal en acabado cromado o pintura epoxi y tablero chapado en haya.



1803Y

Table with metal legs with chrome finish or epoxy paint and beech veneer top. /
Mesa con patas de metal en acabado cromado o pintura epoxi y tablero chapado en haya.



1805Y

Table with metal legs with chrome finish or epoxy paint and beech veneer top. /
Mesa con patas de metal en acabado cromado o pintura epoxi y tablero chapado en haya.



ÍNSULA collection

Design by Patrick Norguet

EN This collection is a system of seats and tables that offer a simple and elegant solution for decorating common spaces. The designer, Patrick Norguet, wants the combination of the pieces in this collection to evoke natural landscapes. Much more than a set, Ínsula is first of all a system: it is made up of a basic structure on which the seats, backrests and accessories are fixed.

This project is conceived as a set of simple construction and combinations, without forgetting the main function, the comfort of its use.

ES Esta colección es un sistema de asientos y mesas que ofrecen una solución sencilla y elegante para vestir espacios comunes. El diseñador, Patrick Norguet, busca que con la combinación de las piezas de esta colección se evoque a los paisajes naturales. Mucho más que un conjunto, Ínsula es antes que nada, un sistema: se compone de una estructura básica sobre la cual se fijan los asientos, los respaldos y los accesorios.

Se concibe este proyecto como un conjunto de construcción simple y de combinaciones, sin olvidar la función principal, la comodidad de su uso.

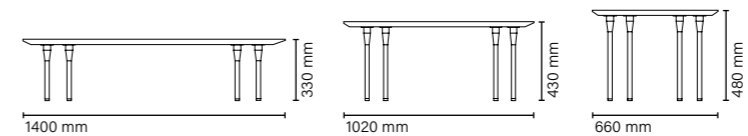



378

379



ÍNSULA collection

Table / Mesa



453H / 453R

Coffe table with steel legs and top in oak veener / Mesa con patas de acero y tapa de madera de roble

Available / Disponible en:
Altura: 32 cm



454H / 454R

Coffe table with steel legs and top in oak veener / Mesa con patas de acero y tapa de madera de roble

Available / Disponible en:
Altura: 42 cm



455H / 455R

Coffe table with steel legs and top in oak veener / Mesa con patas de acero y tapa de madera de roble

Available / Disponible en:
Altura: 48 cm

Credits / Créditos

Art work / Serigrafías

Tramanda

Lightly / Iluminaria

Marset

LZF Lamps

Nistal

Printed in · Impreso en Valencia

Copyright © 2025 Capdell

All rights reserved / Todos los derechos reservados

www.capdell.com