

Boston & Bari

Pata de metal
Metal legs
Pied métallique

fama

3L
FA26

Incluye / It includes / Elle comprend:

A x 8

P x 4

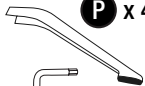

B

C x 4

* La pata ya incluye su protector pero nosotros añadimos este (C), ideal para parquet. Se recomienda no arrastrarlo para que no se despegue.

* The leg already includes its own protector, but we add this one (C) which is special for wooden floors. It is recommended not to drag it to prevent it coming off.

* Le pied comprend déjà un protecteur mais nous lui avons ajouté celui-ci (C), idéal pour le parquet, Il est conseillé de ne pas le traîner afin qu'il ne se décolle pas.

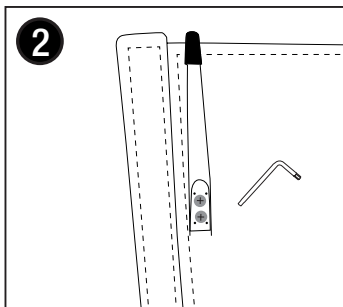
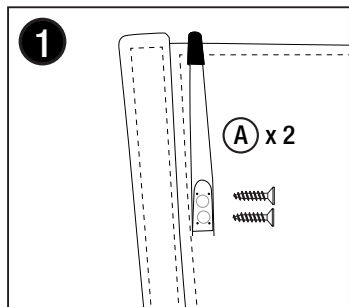
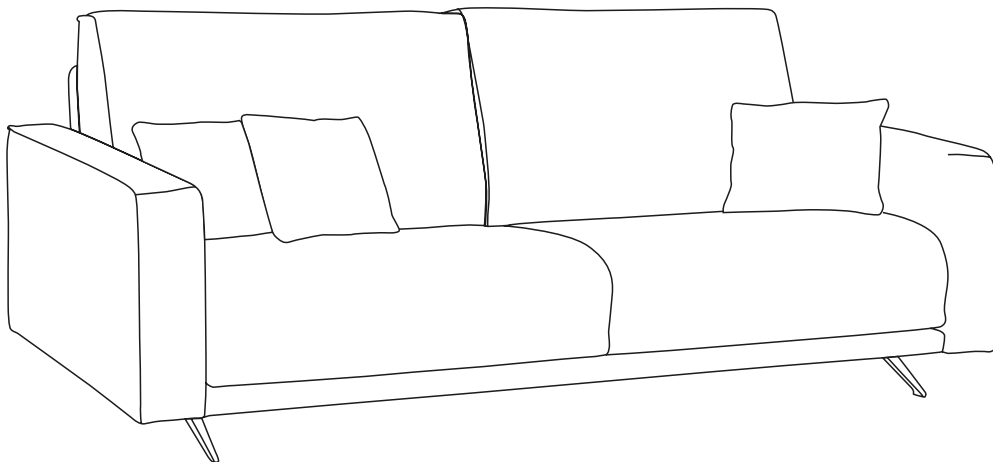

Read Me

*I'm not
rubbish!*

**Chss,
chss**

*Don't say I didn't
warn you...*

*Reading this information could be
beneficial for your and your sofa's health.

fama

CARE AND MAINTENANCE GUIDE FOR YOUR SOFA

We think that it is essential that you take a few minutes to read this short guide. We will try to explain briefly some important features about your sofa/armchair.



Frame and seat suspension guaranty

Normally sofas lose their functionality when the seat suspension breaks or loosens, causing the collapse of the seat. Or it may happen that the frame breaks. In both cases, the sofa becomes completely unusable. With your new Fama sofa you will not have to worry about this. **Our frames have lifetime guaranty, and our seat suspensions are guaranteed for 10 years.**



1. Sofa frames.
2. Webbing process.
3. Back and seat suspensions tests.

Decent ageing

Apart from the frame and suspension, sofas and armchairs have other elements:

- * Seat cushion interior/filling.
- * Back cushion interior/filling.
- * Cushions filling.
- * Fabric or leather.

With use these components suffer a continuous wearing (like our shoes, clothes, etc...)

There is a concept that we like to use, **decent ageing**. It means that we design our sofas and armchairs so that with time and use, the wearing is produced naturally and correctly; it starts becoming obvious that the sofa or armchair is no longer new, but it is still looking well and correct.

All this to make sure that you enjoy your sofa for very long, and to give you some information about how it will wear with time.

*An example of decent ageing in a pair of shoes.



NEW
SHOE



DECENT
AGEING



BAD
AGEING

! Tips for a good “running in”

Before starting to use the sofa, the seat cushion interiors have an initial hardness slightly higher than the sofa you tried at the store. During the first 3 – 4 weeks of use, this hardness will decrease a little bit and then it will stay levelled. Therefore, during the first month of use, it is advisable to seat on the different parts of the sofa

to get a uniform “running in” of the sofa.

The back cushion interiors are normally made out of hollow fibre. At the beginning it may be too hard. It is normal. We make it this way because it will lose some volume with use.

To make sure that your sofa “ages decently”, we recommend you to plump the back and scatter cushions up regularly, just as you normally do with your bed pillows.



* See the drawing below, which shows how to seat on the different parts of the sofa during the first weeks of use to get a good “running in” of the sofa.

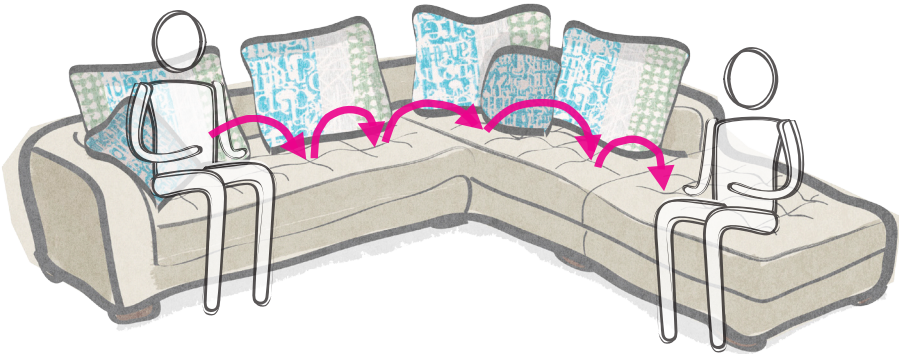

OTHER USEFUL TIPS

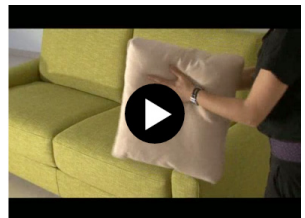

Sometimes, the seat or back cushion covers may show some small wrinkles. It is normal, and we can easily remove them just passing our hand over them.

“How can I keep the cushions in my sofa as when they were new?”, “Can I wash the covers of my sofa in the washing machine?” These are some of the videos that you can watch in our FAQs Section in www.fama.es.

ASPECTS TO CONSIDER

WHEN YOU RECEIVE YOUR fama SOFA/ARMCHAIR

If your armchair is swivel

You should bear in mind that when it swivels it may produce a rubbing sound. If this noise increased loudly with use, the solution would be greasing it with oil or silicon in spray. We don't recommend the use of grease or liquid oil, as they may leak and produce stains on the floor/ carpet.



If it is a recliner

You should also consider that the friction between the different metal parts of the mechanism may generate some rubbing noise. This is normal. If the noise becomes excessive, don't hesitate to contact us.



If it is electric

You should make sure that the cables are always placed on the back part of the armchair, and that they are not held or trapped by the legs or the swivel base.



If it has a battery

You must check the instructions guide, which you will find together with the guaranty label, to make sure you use it correctly.

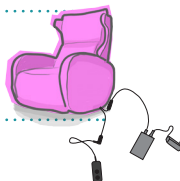

In case of malfunction

(The battery does not work, the footrest stays open, the buttons do not work properly, etc...). You must be calm and check with the store or with us directly.



If any fault or problem arises...

...you can be sure that we will always solve it. We are not one of those companies that always try to avoid complains or create further problems. Our main aim is that you enjoy your sofa for many years.



Guaranty

The guaranty label of any product is something very important that we should keep and read. In it, you will also find many more useful tips about your Fama sofa or armchair.



If you need further information...

...in our Website you can find tutorials and some other helpful Information. Feel free to contact us with any questions to sales@fama.es. We will be happy to help.



www.fama.es

We hope that soon
you will become a new



fama