

SAFARI • SUSPENSION
 REF. 9830.150x40

WEIGHT
 Under request

BULBS
 Quantity: 14
 Type: G9
 Wattage: 40W (max)

GLASS
 Type: Bronze
 Other types: Smoked | Clear

MATERIALS
 Body: Brass | Glass

HEIGHT
 25 cm | 9.8 in

LENGTH **WIDTH**
 160 cm | 63.0 in 40 cm | 15.7 in

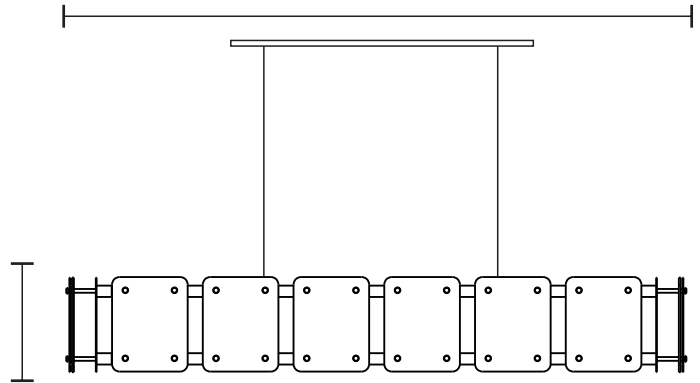

PACKING (approx.)
 Dimensions: 169 x 47 x 47 cm
 66.5 x 18.5 x 18.5 in
 Volume: 0.37 m³ | 13.18 ft³

- CE - Products manufactured according the European norm of security EN 60 598-1.
- F - Products adjusted for instalation in surfaces normally inflammable.
- - Products of class II. The electric isolation is double or reinforced.
- ES - Products with the possibility of instalation of low-energy consumption bulbs.

BASE

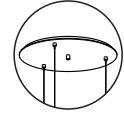
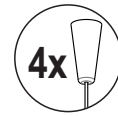

Options: Multiple Canopys | Single Canopy

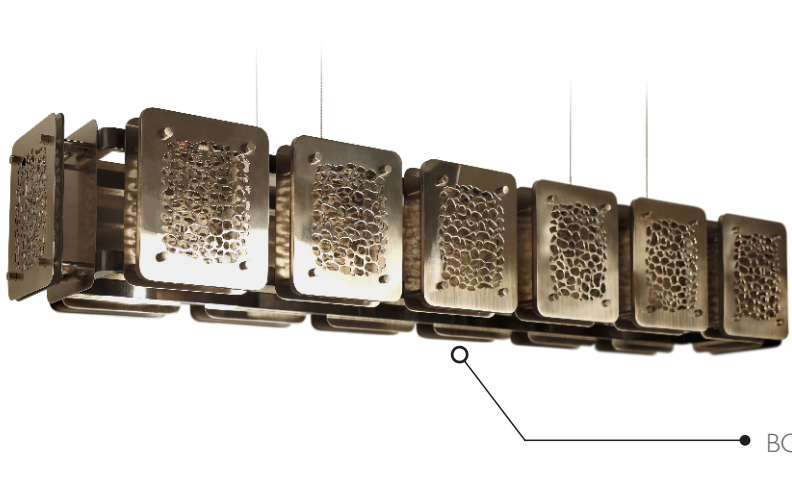

PRODUCT FINISHES & COSTUMIZATION OPTIONS



Gold (Brushed)

BASE:  

Gold (Brushed)

BODY 1: 

+

GLASS: 

Black Nickel

BODY 2: 

MORE FINISHES AVAILABLE HERE:
[CLICK HERE](#)
