

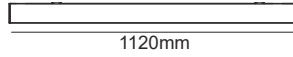





**i** **VIA options**

	68mm 40mm		1120mm
	68mm 40mm		840mm
	68mm 40mm		560mm

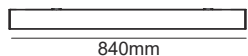
**1**

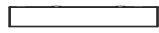
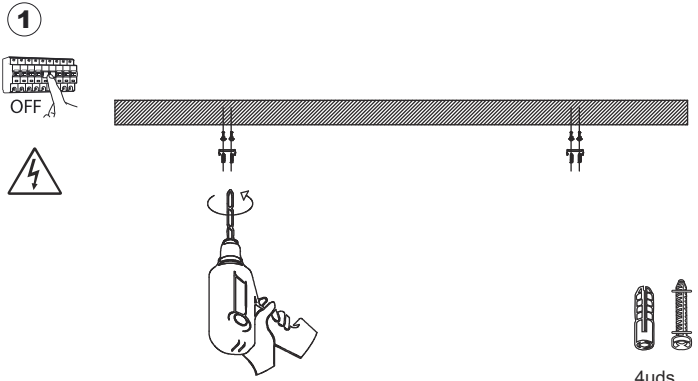

OFF

4uds

**2**

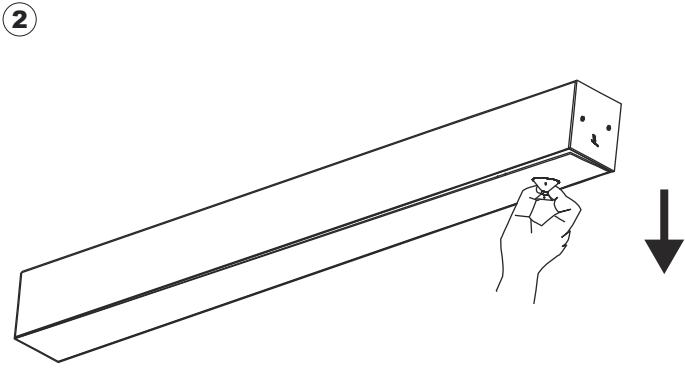

**3**

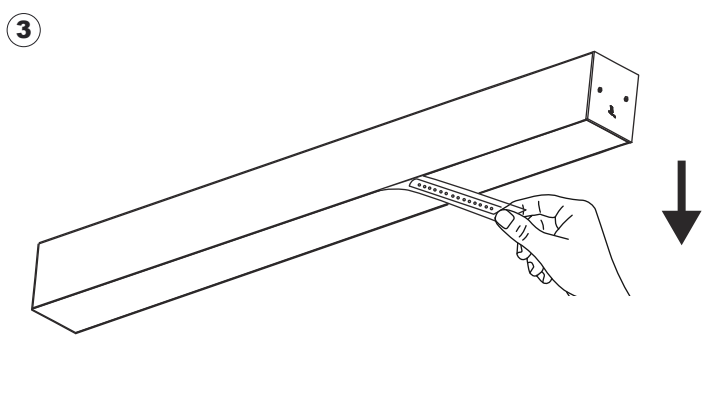

**4**

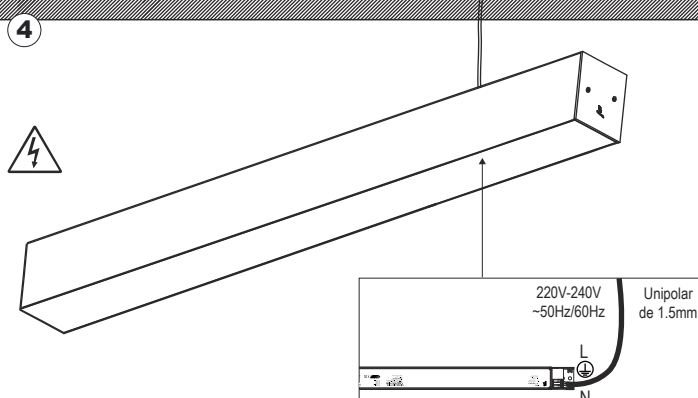

220V-240V  
 ~50Hz/60Hz

Unipolar  
 de 1.5mm

L  
 N

**5**

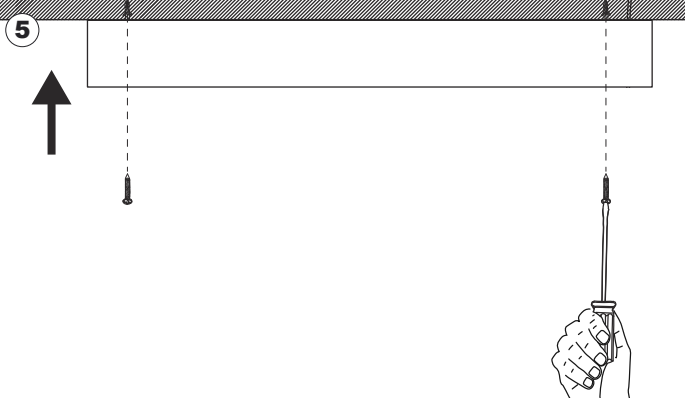

**6**

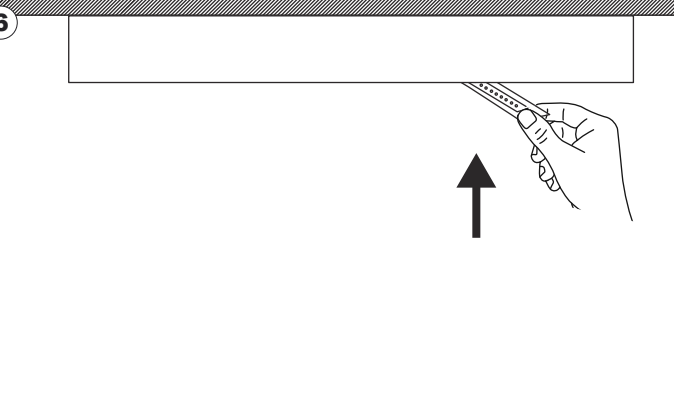

**7**

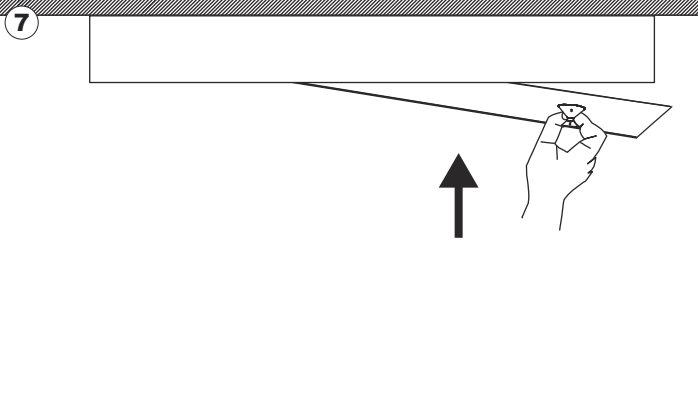

**8**

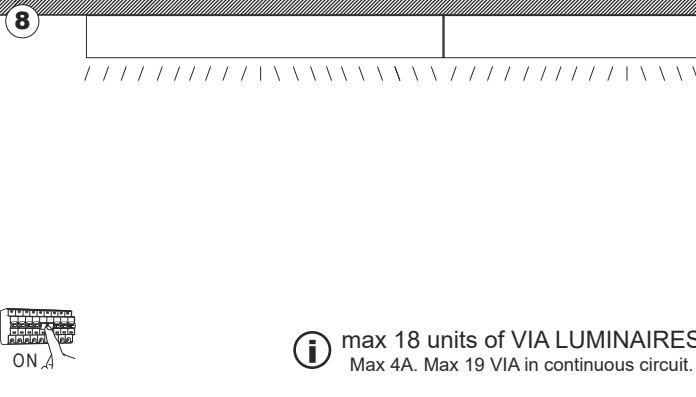

ON

**i** max 18 units of VIA LUMINAIRES  
 Max 4A. Max 19 VIA in continuous circuit.

**TECHNICAL FEATURES - CARACTERISTICAS TÉCNICAS**

 LED light surface. for information visit <a href="http://www.faro.es">www.faro.es</a>	 repair service		 DRIVER INCL	 220-240 v~	 50/60 Hz										 Together we take care of the planet
--	--	---	---	--	---	---	---	---	---	---	---	---	---	---	---



Together  
we take care  
of the planet

#### Together we take care of the planet.

This is why we reduce paper consumption. Please refer to the safety, maintenance and warranty instructions at [www.faro.es](http://www.faro.es). If you cannot access it, call us at +34 937 723 965 or write to [export@faro.es](mailto:export@faro.es).

**Juntos cuidamos el planeta.** Por eso reducimos el consumo de papel. Puedes consultar las instrucciones de seguridad, mantenimiento y garantía en [www.faro.es](http://www.faro.es). Si no puedes acceder, llámanos al +34 902 165 166 o escríbenos a [faro@lorefar.com](mailto:faro@lorefar.com).

**Junts cuidem el planeta.** Per això reduïm el consum de paper. Pots consultar les instruccions de seguretat, manteniment i garantia en [www.faro.es](http://www.faro.es). Si no hi pots accedir, telefona'ns al +34 902 165 166 o escriu-nos a [faro@lorefar.com](mailto:faro@lorefar.com).

**Ensemble, nous prenons soin de la planète.** C'est pourquoi nous réduisons la consommation de papier. Veuillez-vous référer aux instructions de sécurité, d'entretien et de garantie sur [www.faro.es](http://www.faro.es). Si vous ne pouvez pas y accéder, appelez-nous au +34 937 723 965 ou écrivez à [export@faro.es](mailto:export@faro.es).

#### Insieme proteggiamo il pianeta.

Questo è il motivo per il quale abbiamo ridotto il consumo di carta. Per favore, leggi le istruzioni sulla sicurezza, la manutenzione e la garanzia sul sito [www.faro.es](http://www.faro.es). Se non puoi accedere, chiamaci al +34 937 723 965 o scrivici a [export@faro.es](mailto:export@faro.es).

**Juntos cuidamos do planeta.** É por este motivo que reduzimos o consumo de papel. Consulte as instruções de segurança, manutenção e garantia em [www.faro.es](http://www.faro.es). Se não conseguir aceder, ligue para +34 937 723 965 ou escreva para [export@faro.es](mailto:export@faro.es).

**Gemeinsam sorgen wir uns um unseren Planeten.** Deshalb reduzieren wir den Papierverbrauch. Bitte beachten Sie die Sicherheits-, Wartungs- und Garantiehinweise unter [www.faro.es](http://www.faro.es). Wenn Sie nicht darauf zugreifen können, rufen Sie uns unter +34 937 723 965 an oder schreiben Sie an [export@faro.es](mailto:export@faro.es).

**We dragen samen zorg voor onze planeet.** Daarom verminderen wij het papiergebruik. Raadpleeg de veiligheids-, onderhouds- en garantiehandleiding op [www.faro.es](http://www.faro.es). Kan u ze niet raadplegen? Bel ons op +34 937 723 965 of schrijf ons op [export@faro.es](mailto:export@faro.es).

**Μαζί φροντίζουμε τον πλανήτη.** Για αυτόν τον λόγο μειώνουμε την κατανάλωση χαρτιού. Παρακαλούμε, ανατρέξτε στις οδηγίες ασφαλείας, συντήρησης και εγγύησης στην ιστοσελίδα [www.faro.es](http://www.faro.es). Αν δεν μπορείτε να αποκτήσετε πρόσβαση, τηλεφωνήστε μας στο +34 937 723 965 ή γράψτε μας στο [export@faro.es](mailto:export@faro.es).

**Вместе мы заботимся о планете.** Вот почему мы сокращаем потребление бумаги. Пожалуйста, обратитесь к инструкциям по безопасности, техническому обслуживанию и гарантии на сайте [www.faro.es](http://www.faro.es). Если вы не можете получить к нему доступ, позвоните нам по телефону +34 937 723 965 или напишите на [export@faro.es](mailto:export@faro.es).

**Společně pečujeme o planetu.** Proto omezujeme spotřebu papíru. Přečtěte si, prosím, pokyny týkající se bezpečnosti, údržby a záruky na [www.faro.es](http://www.faro.es). Pokud na stránky nemáte přístup, zavolejte nám na tel. +34 937 723 965 nebo napište na [export@faro.es](mailto:export@faro.es).

**Razem dbamy o planetę.** Dlatego zmniejszamy zużycie papieru. Proszę zapoznać się z instrukcjami bezpieczeństwa, konserwacji i gwarancji na [www.faro.es](http://www.faro.es). Jeśli nie możesz uzyskać do niego dostępu, zadzwoń do nas pod numer +34 937 723 965 lub napisz na adres [export@faro.es](mailto:export@faro.es).

**Заедно ние се грижим за планетата.** Ето защо намаляваме консумацията на хартия. Моля, направете справка с инструкциите за безопасност, поддръжка и гаранция на [www.faro.es](http://www.faro.es). Ако нямате достъп до сайта, обадете ни се на +34 937 723 965 или пишете на [export@faro.es](mailto:export@faro.es).

**Spoločne sme sa postarar' o tejto planéte.** To je dôvod, prečo sme znížili spotrebu papiera. Pozri pokyny k bezpečnosti, údržby a záruky na [www.faro.es](http://www.faro.es). Ak nemôžete pristúpoval, zavolajte na telefónne číslo +34 937 723 965 alebo píšite n [export@faro.es](mailto:export@faro.es).

معاً نعتني بالكوكب.

هذا هو السبب في تقليل استهلاك الورق.  
يرجى الرجوع إلى تعليمات السلامة  
والصيانة والضمان على  
[www.faro.es](http://www.faro.es)  
إذا لم تتمكن من الولوج إليه، اتصل بنا  
على +34 937 723 965 أو اكتب رسالة  
إلى [export@faro.es](mailto:export@faro.es)