







A	B	C	D	E	F
 M8x30	 M8x25	 $\phi 17 \times \phi 8 \times 2$	 5mm	 6mm	 $\phi 14 \times \phi 8 \times 2.5$
8 PCS	8 PCS	16PCS	1PC	1PC	8 PCS

FIG.
1

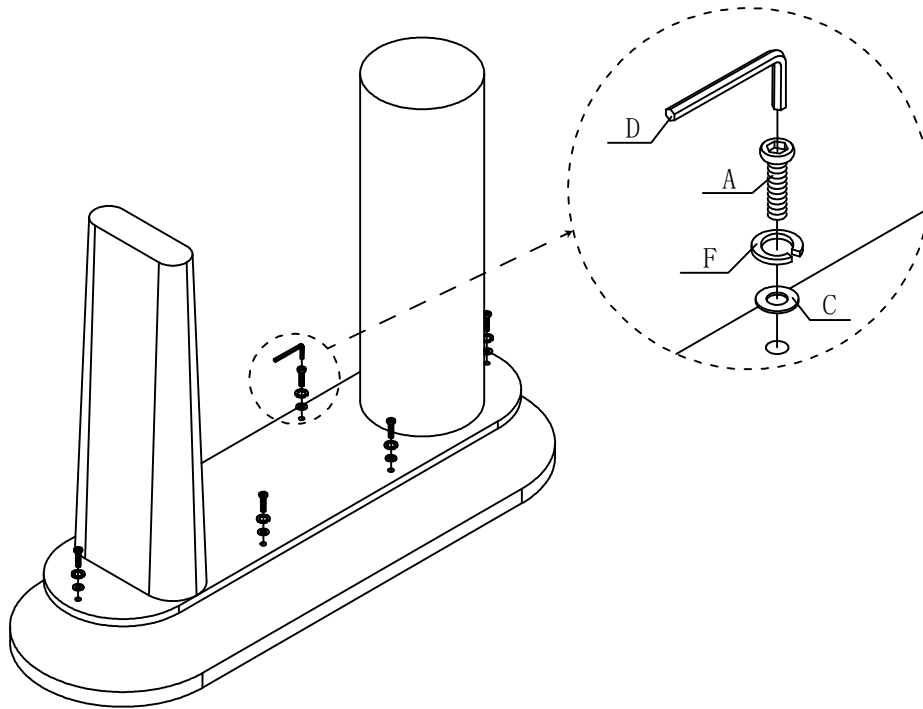
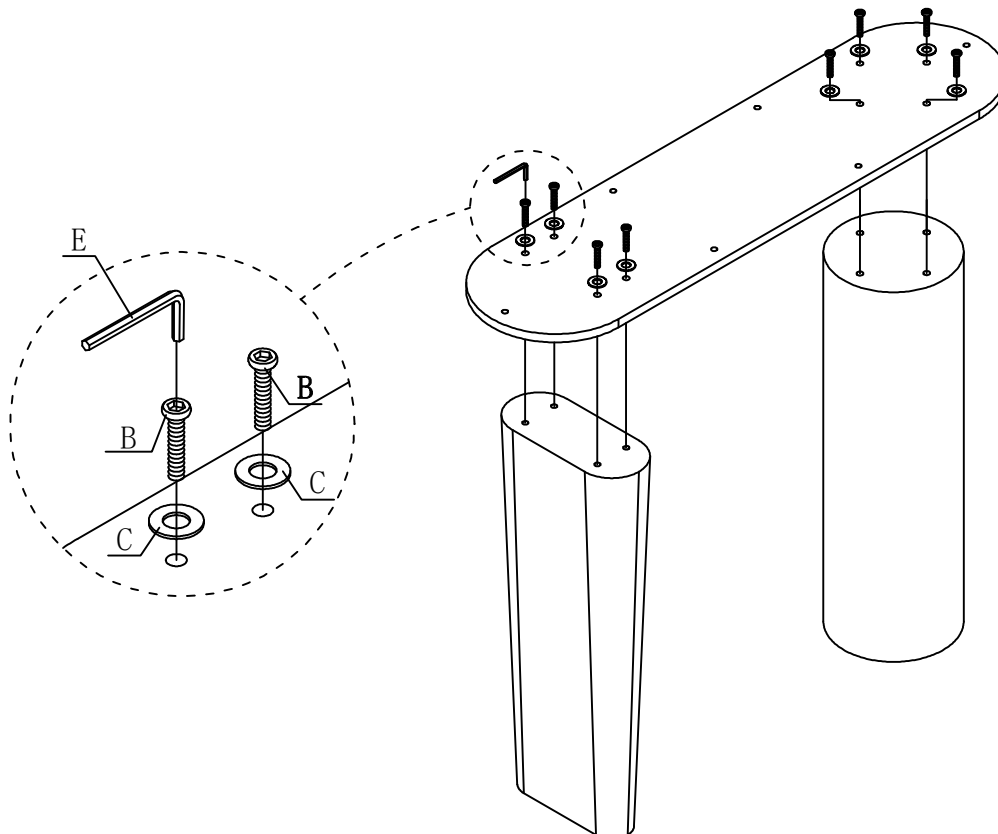

FIG.
2









A	B	C	D	E	F
 M8x30	 M8x25	 φ 17x φ 8x2	 5mm	 6mm	 φ 14x φ 8x2.5
8 PCS	8 PCS	16PCS	1PC	1PC	8 PCS

FIG.
3

