

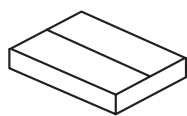

5 min



x1



x1

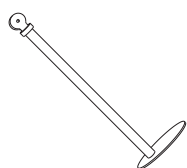

Ax1

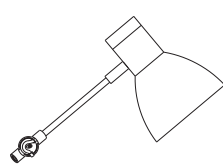

Bx1

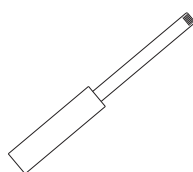

Cx1



Dx1



1

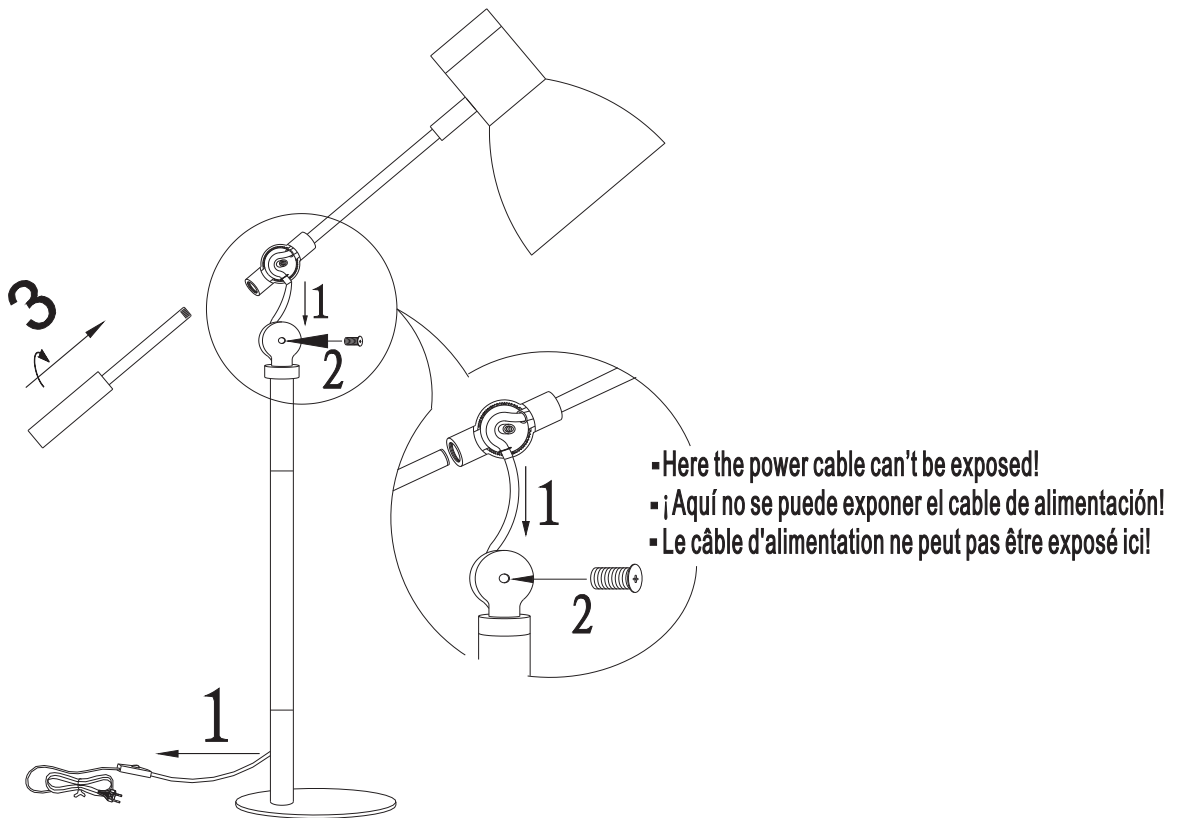



2

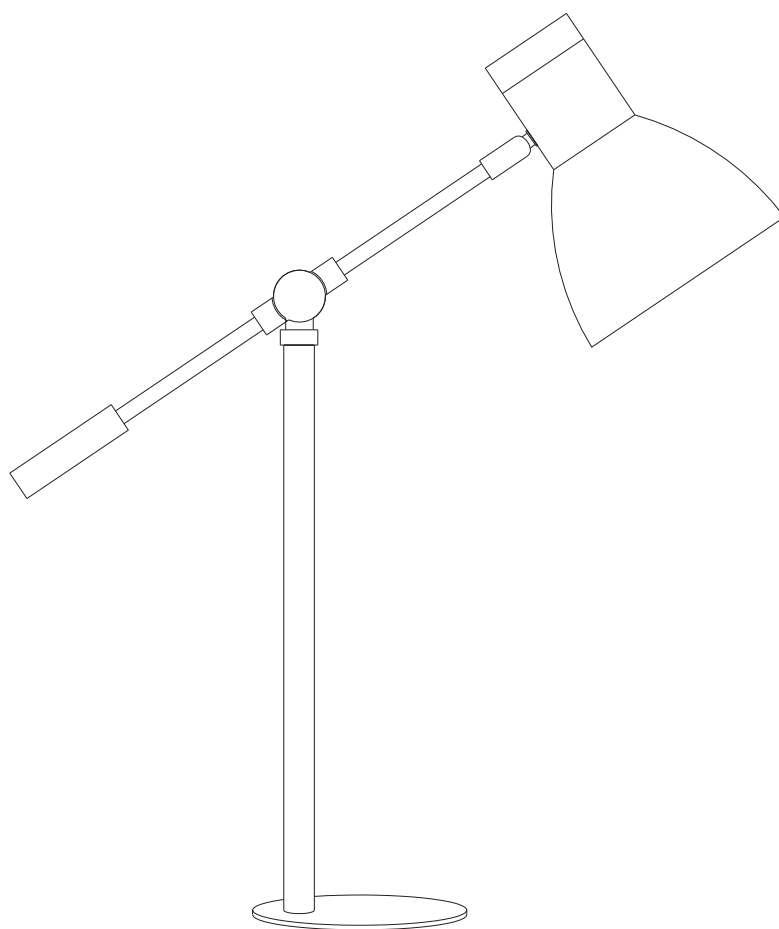





**JULIÀ GRUP Furniture Solutions S.L.**

B-17616277

Pol. Ind. Bosc d'en Cuca

C / Tallers, 14

17410 Sils SPAIN

[contact@kavehome.com](mailto:contact@kavehome.com)