

Gilbert

COFFEE & SIDE TABLES

With a minimalistic design, Gilbert is a table set that includes three different sizes of tables that can be used as a side or coffee table. The coffee table model features an H-shape wooden base while the side tables present a T-shape base. Gilbert tables are accented by their rounded corners that can be customized in lacquered, wood veneers, and even synthetic leather on the top. The best part of Gilbert table set is that you can use them separately or combine them into one ensemble, blending its unique shapes and heights.



Specifications

Dimensions (Gilbert S)

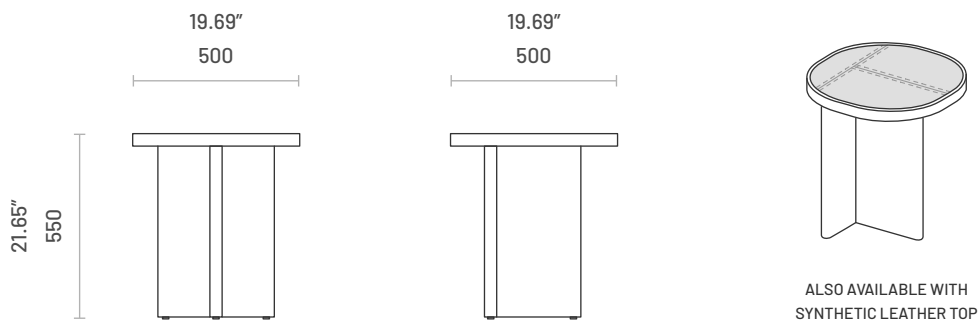

Dimensions (Gilbert M)

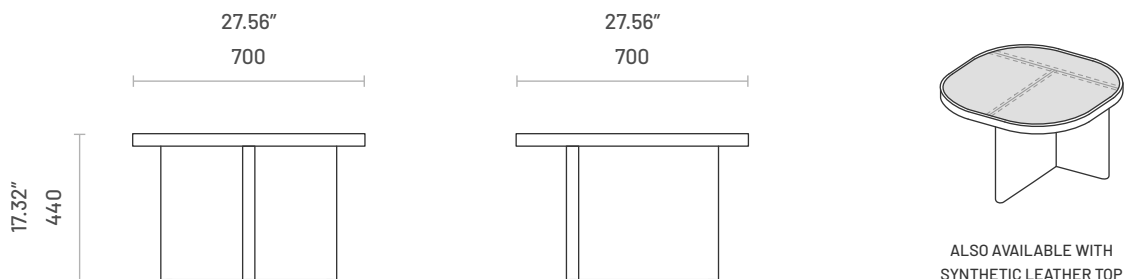

Specifications

Dimensions (Gilbert L)

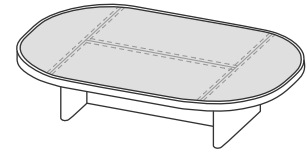
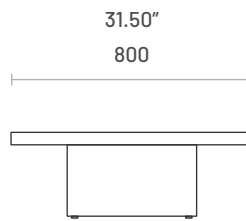
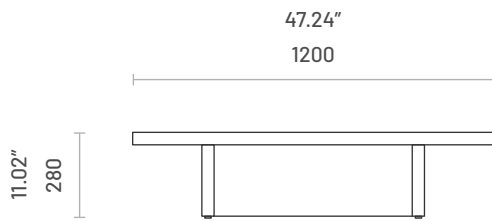

ALSO AVAILABLE WITH
SYNTHETIC LEATHER TOP

Technical Information

Frame

Structure: MDF and wood veneer

Top: MDF, wood veneer and synthetic leather

Materials and Finishes



Overview



Available Finishes

	1	2
Wood Veneers		
Natural Oak	•	•
Natural Walnut	•	•
Fumé Eucalyptus	•	•
Fumé Oak	•	•
Lacquers		
Bone	•	•
Taupe	•	•
Olive	•	•
Syrah	•	•
Ocean	•	•
Black	•	•
Synthetic Leathers		
Rupert	—	•

COM Fabric and Leather Requirements

Item	1
Gilbert S	Fabric  1.00 lm 3.28 ft
Gilbert M	Fabric  1.00 lm 3.28 ft
Gilbert L	Fabric  1.00 lm 3.28 ft