











A	B	C	D	E	F	H	
							
4 PCS	4 PCS	8 PCS	6 PCS	56 PCS	3 PCS	2 PCS	
I	K	L					
							4 PCS

FIG.
1,2

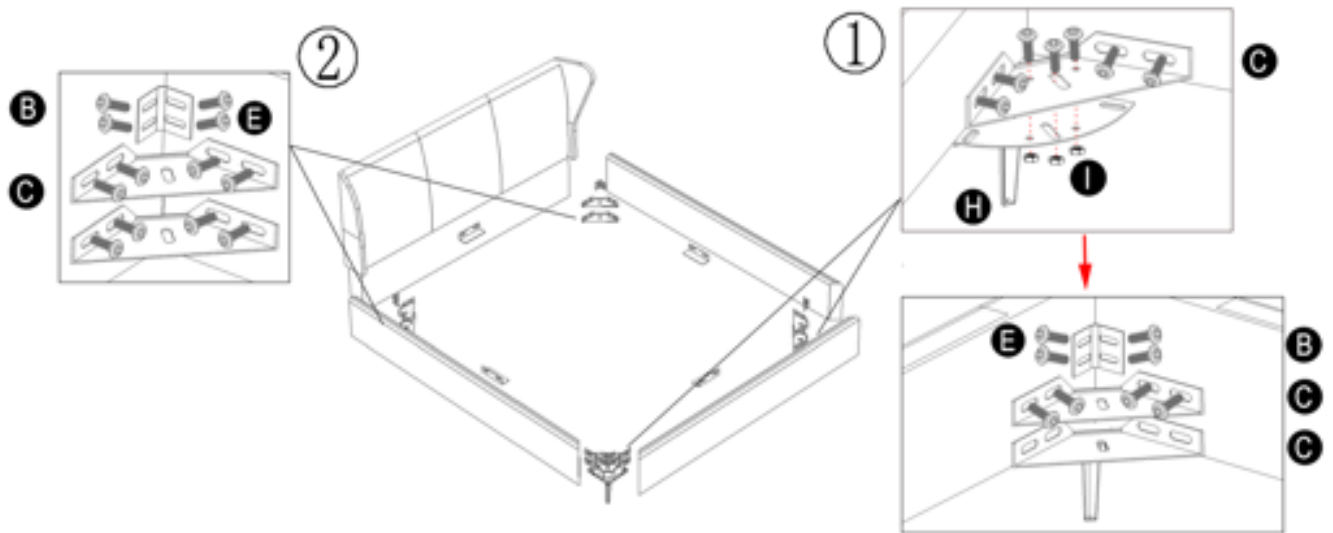
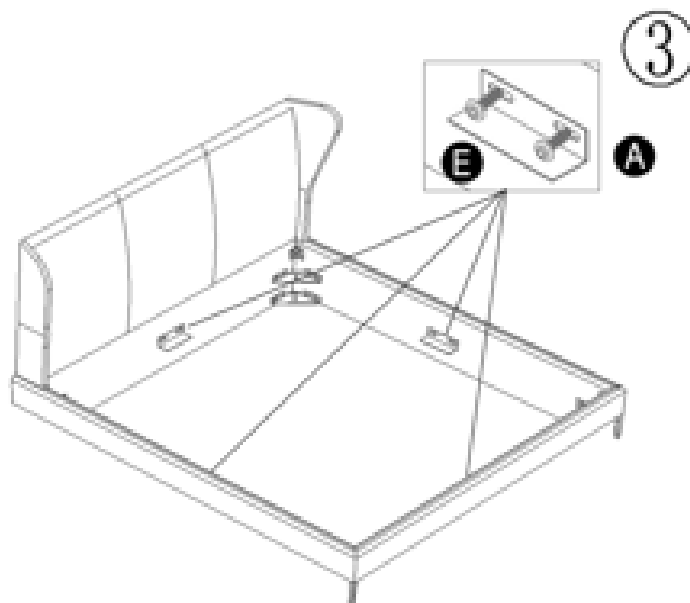

FIG.
3











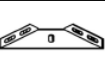

A	B	C	D	E	F	H
			 8*50mm	 8*25mm		
4 PCS	4 PCS	8 PCS	6 PCS	56 PCS	3 PCS	2 PCS
I	K	L				
 8*25mm						
4 PCS	1 PC	1 PC				

FIG.
4

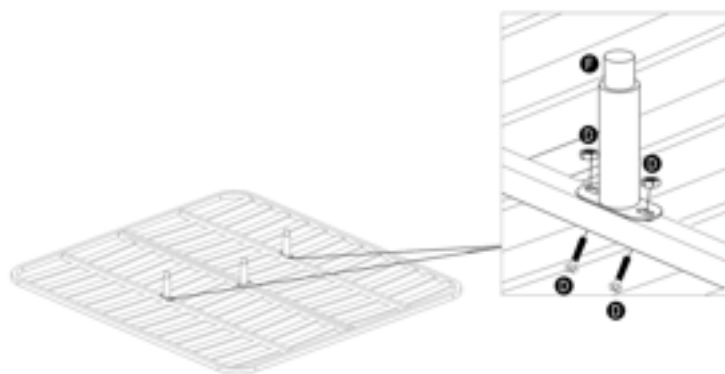

FIG.
5

